

NBSIR 74-391

ELECTROMAGNETIC NOISE IN LUCKY FRIDAY MINE

W. W. Scott, NBS
J. W. Adams, NBS
W. D. Bensema, NBS
H. Dobroski, U. S. Bureau of Mines

Electromagnetics Division
Institute for Basic Standards
National Bureau of Standards
Boulder, Colorado 80302

The views and conclusions contained in this document should not be interpreted as necessarily representing the official policies or recommendations of the Interior Department's Bureau of Mines of the U. S. Government.

October 1974

Prepared for
U. S. Bureau of Mines
Pittsburgh Mining and Safety Research Center
4800 Forbes Avenue
Pittsburgh, Pennsylvania 15213
Working Fund Agreement HO 133005



U.S. DEPARTMENT OF COMMERCE, Frederick B. Dent, Secretary

NATIONAL BUREAU OF STANDARDS, Richard W. Roberts, Director

CONTENTS

| | <u>Page</u> |
|--|-------------|
| 1. INTRODUCTION----- | 1 |
| 1.1 Background----- | 2 |
| 1.2 Mine Description----- | 4 |
| 2. MEASUREMENT INSTRUMENTATION----- | 6 |
| 3. SPECTRUM MEASUREMENT RESULTS----- | 13 |
| 3.1 Introduction----- | 13 |
| 3.2 Surface Noise Measurements----- | 13 |
| 3.2.1 Hoist House----- | 13 |
| 3.2.2 Head Frame----- | 14 |
| 3.2.3 Noise Near Business District, Center of Town----- | 15 |
| 3.3 Spectra at Levels Within the Mine----- | 16 |
| 3.3.1 The 1450 Level----- | 16 |
| 3.3.2 The 3650 Level----- | 17 |
| 3.3.3 The 4050 Level----- | 17 |
| 3.4 Spectra Obtained from Cage Runs, Loop Antenna--- | 21 |
| 3.4.1 Mine Not in Operation----- | 21 |
| 3.4.2 Mine in Operation----- | 22 |
| 4. AMPLITUDE PROBABILITY DISTRIBUTION MEASUREMENTS----- | 74 |
| 4.1 Introduction and Uncertainties----- | 74 |
| 4.2 Results----- | 75 |
| 4.3 RMS and Average Values----- | 76 |
| 4.4 Summary Curves----- | 77 |
| 5. NOISE AND ATTENUATION MEASUREMENTS ALONG THE HOIST ROPE----- | 114 |
| 5.1 Noise Measurements----- | 114 |
| 5.2 Attenuation Measurements----- | 115 |
| 6. CONCLUSIONS----- | 126 |
| 7. RECOMMENDATIONS----- | 126 |
| 8. ACKNOWLEDGMENTS----- | 126 |
| 9. REFERENCES----- | 127 |
| 10. APPENDIX----- | 128 |

LIST OF FIGURES

| | | <u>Page</u> |
|-------------|---|-------------|
| Figure 1-1. | Isometric projection of Lucky Friday Mine--- | 5 |
| Figure 2-1. | Block diagram of portable instrumentation, first system----- | 8 |
| Figure 2-2. | Second field recording system, first configuration----- | 9 |
| Figure 2-3. | Second field recording system, second con- figuration; used to record data for APD's--- | 10 |
| Figure 2-4. | Second field recording system, third con- figuration; it recorded data for APD's on 3650 level----- | 11 |
| Figure 2-5. | Second field recording system, fourth con- figuration; it was used on hoist runs up and down shaft----- | 12 |
| Figure 3-1. | Spectrum of magnetic field strength, hoist house----- | 24 |
| Figure 3-2. | Spectrum of magnetic field strength, hoist house----- | 25 |
| Figure 3-3. | Spectrum of magnetic field strength, head- frame----- | 26 |
| Figure 3-4. | Spectrum of magnetic field strength, head- frame----- | 27 |
| Figure 3-5. | Spectrum of magnetic field strength, head- frame----- | 28 |
| Figure 3-6. | Spectrum of magnetic field strength, head- frame----- | 29 |
| Figure 3-7. | Spectrum of magnetic field strength, head- frame----- | 30 |
| Figure 3-8. | Spectrum of magnetic field strength, head- frame----- | 31 |

LIST OF FIGURES (Continued)

| | | <u>Page</u> |
|--------------|--|-------------|
| Figure 3-9. | Spectrum of magnetic field strength, head-frame----- | 32 |
| Figure 3-10. | Spectrum of magnetic field strength, head-frame----- | 33 |
| Figure 3-11. | Spectrum of magnetic field strength, Cedar Street, Wallace, Idaho----- | 34 |
| Figure 3-12. | Spectrum of magnetic field strength, Cedar Street, Wallace, Idaho----- | 35 |
| Figure 3-13. | Spectrum of magnetic field strength, Cedar Street, Wallace, Idaho----- | 36 |
| Figure 3-14. | Spectrum of magnetic field strength, 1450 level----- | 37 |
| Figure 3-15. | Spectrum of magnetic field strength, 1450 level----- | 38 |
| Figure 3-16. | Spectrum of magnetic field strength, 3650 level----- | 39 |
| Figure 3-17. | Spectrum of magnetic field strength, 3650 level----- | 40 |
| Figure 3-18. | Spectrum of magnetic field strength, 3650 level----- | 41 |
| Figure 3-19. | Plan view of portion of 4050 level, Lucky Friday Mine----- | 42 |
| Figure 3-20. | Spectrum of magnetic field strength, 4050 level----- | 43 |
| Figure 3-21. | Spectrum of magnetic field strength, 4050 level----- | 44 |
| Figure 3-22. | Spectrum of magnetic field strength, 4050 level----- | 45 |
| Figure 3-23. | Spectrum of magnetic field strength, 4050 level----- | 46 |

LIST OF FIGURES (Continued)

| | <u>Page</u> |
|--|-------------|
| Figure 3-24. Spectrum of magnetic field strength, 4050 level----- | 47 |
| Figure 3-25. Spectrum of magnetic field strength, 4050 level----- | 48 |
| Figure 3-26. Spectrum of magnetic field strength, 4050 level----- | 49 |
| Figure 3-27. Spectrum of magnetic field strength, 4050 level----- | 50 |
| Figure 3-28. Spectrum of magnetic field strength, 4050 level----- | 51 |
| Figure 3-29. Spectrum of magnetic field strength, 4050 level----- | 52 |
| Figure 3-30. Spectrum of magnetic field strength, 4050 level----- | 53 |
| Figure 3-31. Spectrum of magnetic field strength, 4050 level----- | 54 |
| Figure 3-32. Spectrum of magnetic field strength, 4050 level----- | 55 |
| Figure 3-33. Spectrum of magnetic field strength, 4050 level----- | 56 |
| Figure 3-34. Spectrum of magnetic field strength, 4050 level----- | 57 |
| Figure 3-35. Spectrum of magnetic field strength, 4050 level----- | 58 |
| Figure 3-36. Spectrum of magnetic field strength, zero level----- | 59 |
| Figure 3-37. Spectrum of magnetic field strength, 4050 level----- | 60 |
| Figure 3-38. Spectrum of magnetic field strength, zero level----- | 61 |

LIST OF FIGURES (Continued)

| | | <u>Page</u> |
|--------------|---|-------------|
| Figure 3-39. | Spectrum of magnetic field strength, 150 level----- | 62 |
| Figure 3-40. | Spectrum of magnetic field strength, 1450 level----- | 63 |
| Figure 3-41. | Spectrum of magnetic field strength, 3400 level----- | 64 |
| Figure 3-42. | Spectrum of magnetic field strength, 4250 level----- | 65 |
| Figure 3-43. | Spectrum of voltage across a 50 ohm load, 4250 level----- | 66 |
| Figure 3-44. | Spectrum of magnetic field strength, 4250 level----- | 67 |
| Figure 3-45 | Spectrum of voltage across a 50 ohm load (comparison of strong unknown source and typical noise)----- | 68 |
| Figure 3-46. | Spectrum of magnetic field strength, 4250 level----- | 69 |
| Figure 3-47. | Spectrum of magnetic field strength, 4250 level----- | 70 |
| Figure 3-48. | Spectrum of voltage across a 50 ohm load (unknown narrowband sources)----- | 71 |
| Figure 3-49. | Spectrum of voltage across a 50 ohm load (unknown narrowband sources)----- | 72 |
| Figure 3-50. | Spectrum of magnetic field strength, 1800 level----- | 73 |
| Figure 4-1. | APD, 30 kHz, headframe----- | 78 |
| Figure 4-2. | APD, 70 kHz, headframe----- | 79 |
| Figure 4-3. | APD, 150 kHz, headframe----- | 80 |
| Figure 4-4. | APD, 250 kHz, headframe----- | 81 |

LIST OF FIGURES (Continued)

| | <u>Page</u> |
|--|-------------|
| Figure 4-5. APD, 30 kHz, headframe----- | 82 |
| Figure 4-6. APD, 70 kHz, headframe----- | 83 |
| Figure 4-7. APD, 150 kHz, headframe----- | 84 |
| Figure 4-8. APD, 250 kHz, headframe----- | 85 |
| Figure 4-9. APD, 30 kHz, 1450 level----- | 86 |
| Figure 4-10. APD, 70 kHz, 1450 level----- | 87 |
| Figure 4-11. APD, 150 kHz, 1450 level----- | 88 |
| Figure 4-12. APD, 250 kHz, 1450 level----- | 89 |
| Figure 4-13. APD, 30 kHz, 1450 level----- | 90 |
| Figure 4-14. APD, 70 kHz, 1450 level----- | 91 |
| Figure 4-15. APD, 150 kHz, 1450 level----- | 92 |
| Figure 4-16. APD, 250 kHz, 1450 level----- | 93 |
| Figure 4-17. APD, 30 kHz, 3050 level----- | 94 |
| Figure 4-18. APD, 70 kHz, 3050 level----- | 95 |
| Figure 4-19. APD, 150 kHz, 3050 level----- | 96 |
| Figure 4-20. APD, 30 kHz, 3050 level----- | 97 |
| Figure 4-21. APD, 70 kHz, 3050 level----- | 98 |
| Figure 4-22. APD, 150 kHz, 3050 level----- | 99 |
| Figure 4-23. APD, 35 kHz, 3650 level----- | 100 |
| Figure 4-24. APD, 75 kHz, 3650 level----- | 101 |
| Figure 4-25. APD, 200 kHz, 3650 level----- | 102 |
| Figure 4-26. APD, 35 kHz, 3650 level----- | 103 |
| Figure 4-27. APD, 75 kHz, 3650 level----- | 104 |

LIST OF FIGURES (Continued)

| | <u>Page</u> |
|---|-------------|
| Figure 4-28. APD, 200 kHz, 3650 level----- | 105 |
| Figure 4-29. Summary curves, headframe, horizontal (north-south) component----- | 106 |
| Figure 4-30. Summary curves, headframe, vertical com- ponent----- | 107 |
| Figure 4-31. Summary curves, 1450 level, vertical com- ponent----- | 108 |
| Figure 4-32. Summary curves, 1450 level, horizontal (north-south) component----- | 109 |
| Figure 4-33. Summary curves, 3050 level, horizontal (north-south) component----- | 110 |
| Figure 4-34. Summary curves, 3050 level, vertical com- ponent----- | 111 |
| Figure 4-35. Summary curves, 3650 level, horizontal (north-south) component----- | 112 |
| Figure 4-36. Summary curves, 3650 level, vertical com- ponent----- | 113 |
| Figure 5-1. EM noise in mine shaft, mine not in opera- tion, 49 kHz----- | 116 |
| Figure 5-2. EM noise in mine shaft, mine not in opera- tion, 49 kHz----- | 117 |
| Figure 5-3. EM noise in mine shaft, mine not in opera- tion, 35 kHz----- | 118 |
| Figure 5-4. EM noise in mine shaft, mine not in opera- tion, 35 kHz----- | 119 |
| Figure 5-5. EM noise in mine shaft, mine in operation, 75 kHz and 100 kHz----- | 120 |
| Figure 5-6. EM noise in mine shaft, mine in operation, 52 kHz and 75 kHz----- | 121 |

LIST OF FIGURES (Continued)

| | <u>Page</u> |
|---|-------------|
| Figure 5-7. EM noise in mine shaft, mine in operation, 52 kHz and 35 kHz----- | 122 |
| Figure 5-8. EM noise in mine shaft, mine in operation, 100 kHz and 75 kHz----- | 123 |
| Figure 5-9. Received signal at cage from 35 kHz source at headframe----- | 124 |
| Figure 5-10. Received signal at cage from 50 kHz source at headframe----- | 125 |

ELECTROMAGNETIC NOISE IN LUCKY FRIDAY MINE

Measurements of the absolute value of electromagnetic noise and attenuation along a hoist rope were made in an operating hard-rock mine, Lucky Friday Mine, located near Wallace, Idaho. Spectra of electromagnetic noise generated by various pieces of equipment, spectra of specific noise signals at various depths, and noise and attenuation on the 4250 foot (1295 meter) hoist, were measured. Three techniques were used to make the measurements. First, noise was measured over the entire electromagnetic spectrum of interest for brief time periods. Data were recorded using broadband analog magnetic tape for later transformation to spectral plots. Second, noise amplitudes were recorded at several discrete frequencies for a sufficient amount of time to provide data for amplitude probability distributions. A third technique gave attenuation data through the direct measurement of field strength at various depths.

The specific measured results are given in a number of spectral plots, amplitude probability distribution plots and amplitude curves as a function of depth.

Key words: Amplitude probability distribution; digital data; electromagnetic interference; electromagnetic noise; emergency communications; Fast Fourier Transform; Gaussian distribution; impulsive noise; magnetic field strength; measurement instrumentation; mine noise; spectral density; time-dependent spectral density.

1. INTRODUCTION

This report gives data concerning electromagnetic noise in a hard-rock mine. In this section, background information and a brief mine description are covered. In Section 2, measurement instrumentation is discussed. In Section 3, spectral plots of data are presented. In Section 4, amplitude probability distributions (APD) of magnetic-field noise are given. In Section 5, the results of direct measurements of field strength are given, from which attenuation may be computed. The last two sections (6 and 7) cover conclusions and recommendations.

Only representative samples of the total data measured are given in this report, and only a limited set of data-presentation formats have been used. If additional data, or data presentation in other formats, are required, please contact any of the authors. With the specific permission of the Bureau of Mines, we will supply the additional data. A more complete description of the measurement systems used is given in the Robena Mine report [1].

1.1 Background

The lack of reliable communication systems in mines is a long-standing problem. For emergency use, when all power in a mine is off, the residual electromagnetic noise is no problem. However, if a communication system were designed only for emergency use, it would have three serious drawbacks. First, it would not be ready for immediate use in an emergency; second, it would not be of any value during normal operations; and third, even during emergencies, some power must usually be present. Therefore, the Bureau of Mines decided to design a communication system that could be used for both emergency and normal operational conditions.

Also, two-way communication to personnel in a moving hoist is desirable for normal operating conditions, and is necessary in emergency conditions.

During operation, the machinery used in mines creates a wide range of many types of intense electromagnetic interference (EMI). This EMI is a major limiting factor in the design of a communication system.

The work reported here gives the results of comprehensive measurements of this EMI in critical communication locations, particularly along the hoist path at various depths.

Several EMI parameters can be measured: magnetic field strength, H ; electric field strength, E ; conducted current, i ; and voltage, v , between two conductors. Two parameters were emphasized: magnetic field strength measured with loop antennas and noise currents on the hoist cable measured with a clamp-on toroid. (Hoist cables will be referred to a 'ropes' hereafter.)

There are several reasons for emphasizing the measurement of the magnetic field strength. First, at any air-earth interface, only the magnetic field is essentially undisturbed, while the electric field is severely reduced. Second, any currents will induce magnetic fields, and hence measurement of the magnetic field will directly reflect currents. Third, power line voltages are propagated as transmission line phenomena, and are directly related to transmission line currents and the magnetic fields induced. Thus, measuring magnetic field strength gives a representative composite picture of noise from currents and voltages from most sources, including arcing equipment.

Voltage from the toroid is measured to determine signal strength, noise, and hence signal-to-noise ratios for design information for a specific system, a two-way hoist-phone.

Although magnetic field strength measurements are emphasized here, even this one parameter is difficult to measure meaningfully. The IEEE definition [2] of magnetic field strength, H (magnitude of the magnetic field vector), is used in this report. Since there are a multitude of different sources that generate all known types of noise, the resultant magnetic field strength noise vector is a function of frequency, time, orientation, and location. Small variations in these parameters can cause several orders of magnitude difference in measured field strength.

1.2 Mine Description

The results and data presented in this report are based on measurements made on August 25, 26, and 27, 1973, and on February 8, 1974, in the Lucky Friday Mine and other locations near Wallace, Idaho. The mine, shown in figure 1-1, belongs to Hecla Mining Company and produces ore containing lead, silver, and zinc. Access is by way of a single, double-drum hoist, using the No. 2 shaft. There are two hoists on the No. 2 shaft. Ore is removed from the stopes via raises and drifts and then is removed from the mine by the same hoist personnel use. Some equipment is dc powered: the 5-ton, 90 cell, battery-powered locomotives, and the 1250 horsepower motor used to raise the hoists. Much equipment uses ac power at 120, 440, and 2400 volts: air-conditioners, ventilation systems, compressors, lighting, and battery chargers. Other equipment uses compressed air.

Shifts run to 3:00 p.m., 4:00 p.m., 11:00 p.m., 12 a.m., and 7:00 a.m.; blasting is scheduled at 2:20 p.m., 11:20 p.m., and 6:20 a.m.

The temperature and humidity are high, although not excessive in most places.

Of particular interest in this measurement effort is how signals and noise propagate along the shaft, with and without hoist ropes. Power cables and compressed-air pipes, as well as sand-transport pipes, run in this same shaft, so there is always a composite, single conductor present to serve as one wire of a two wire transmission line. The presence of either hoist rope strongly affects transmission characteristics along the shaft by providing a second wire of a two-wire transmission line.

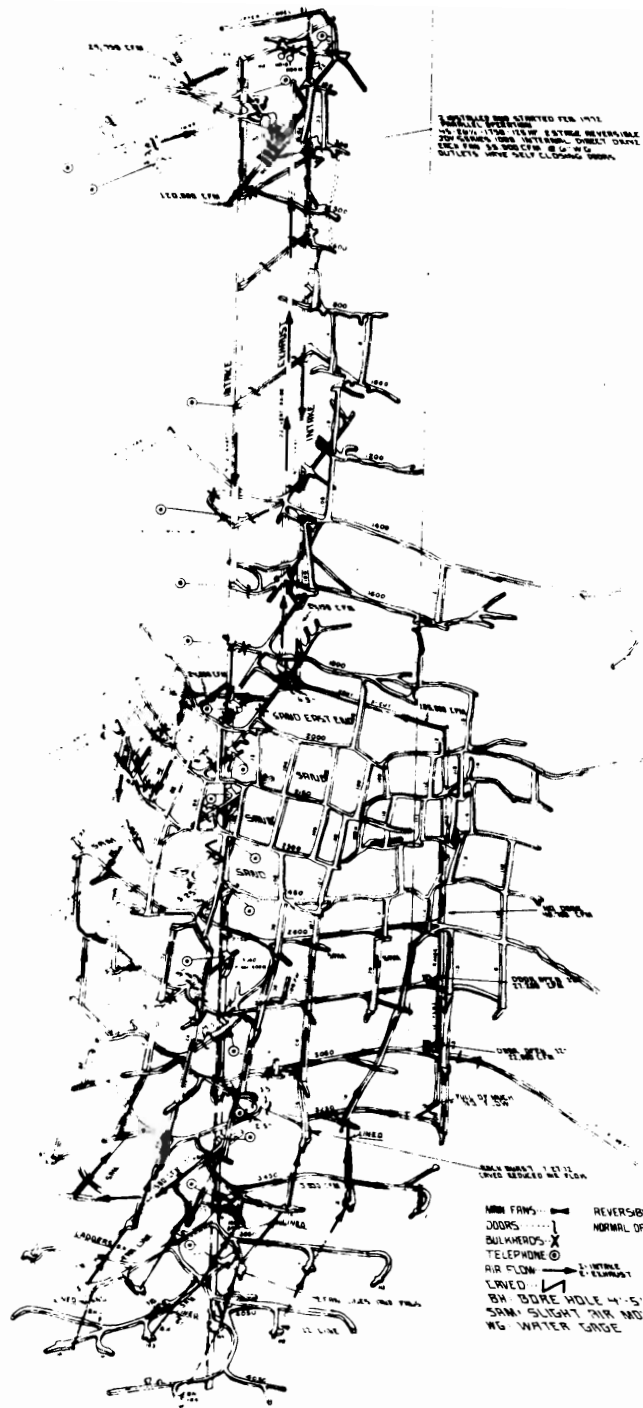

Figure 1-1 Isometric Projection of Lucky Friday Mine.

2. MEASUREMENT INSTRUMENTATION

Three measurement techniques were used. The first covers a large portion of the spectrum as a "snapshot" at one instant of time. In three-dimensional form, several such "snap-shots" can show how drastically a signal varies not only with frequency but also with time. The second technique gives variations over a 20-minute time interval as a view over a narrow frequency window. Usually, noise was measured at a set of four different frequencies. Both techniques were used to measure two orthogonal components of magnetic field strength by either using two systems simultaneously or by varying the orientation of one system. Both techniques were used in as many different locations as possible. Whether the noise signal tends to be Gaussian or impulsive depends on the number of sources and the distance to each source. With the third technique, values of field strength at various levels under various conditions were recorded. These measurements gave attenuation values, complicated mainly by severe standing-wave patterns. Noise levels were recorded also, but values taken this way cannot meaningfully relate the time variations of the noise parameter. The values given are within the bounds indicated in the APD's.

All measured noise is reported in absolute quantities (instead of relative) to allow others to make effective use of the data. For the magnetic field strength measurements, the NBS field calibration site is used with each complete measurement system to assure correct system calibration [3].

The mine environment is generally humid, dusty, hot, and poorly lighted. This complicated the measurement process. Most of our portable measuring equipment was battery-operated, dust-protected, and permissible.

Two types of noise are recorded in the spectral plots, and hence two different magnetic field strength parameters are required, H and H_d . Results are given as the rms value of one component of magnetic field strength, H , versus frequency for discrete frequencies; it is given as one component of magnetic-field-strength spectrum density level [2], H_d , versus frequency for broadband noise in the spectral plots. In the amplitude probability distributions, results are given as the rms value of one component of magnetic field strength versus percent of time this value is exceeded. The APD gives the distribution of the actual instantaneous values only as far as the measurement-system detector bandwidth will allow the detector to follow the time variations of the actual magnetic field. (In this context, noise envelope is sometimes used.) Thus, the results are applicable for a communication receiver whose bandwidth is similar to the measurement-system detector bandwidth.

Two measurement systems were used to make measurements underground. One system was configured four different ways. Five block diagrams are shown in figures 2-1 through 2-5. For a detailed description of these systems, see previous reports [1,4]. The systems used in Lucky Friday are the ones used in previous mine measurement but are configured differently in some cases.

The first system measures data for spectral plots and is fully permissible and portable. The second system is not permissible but is transportable; it records data for both spectral plots and statistical presentations, e.g., amplitude probability distributions.

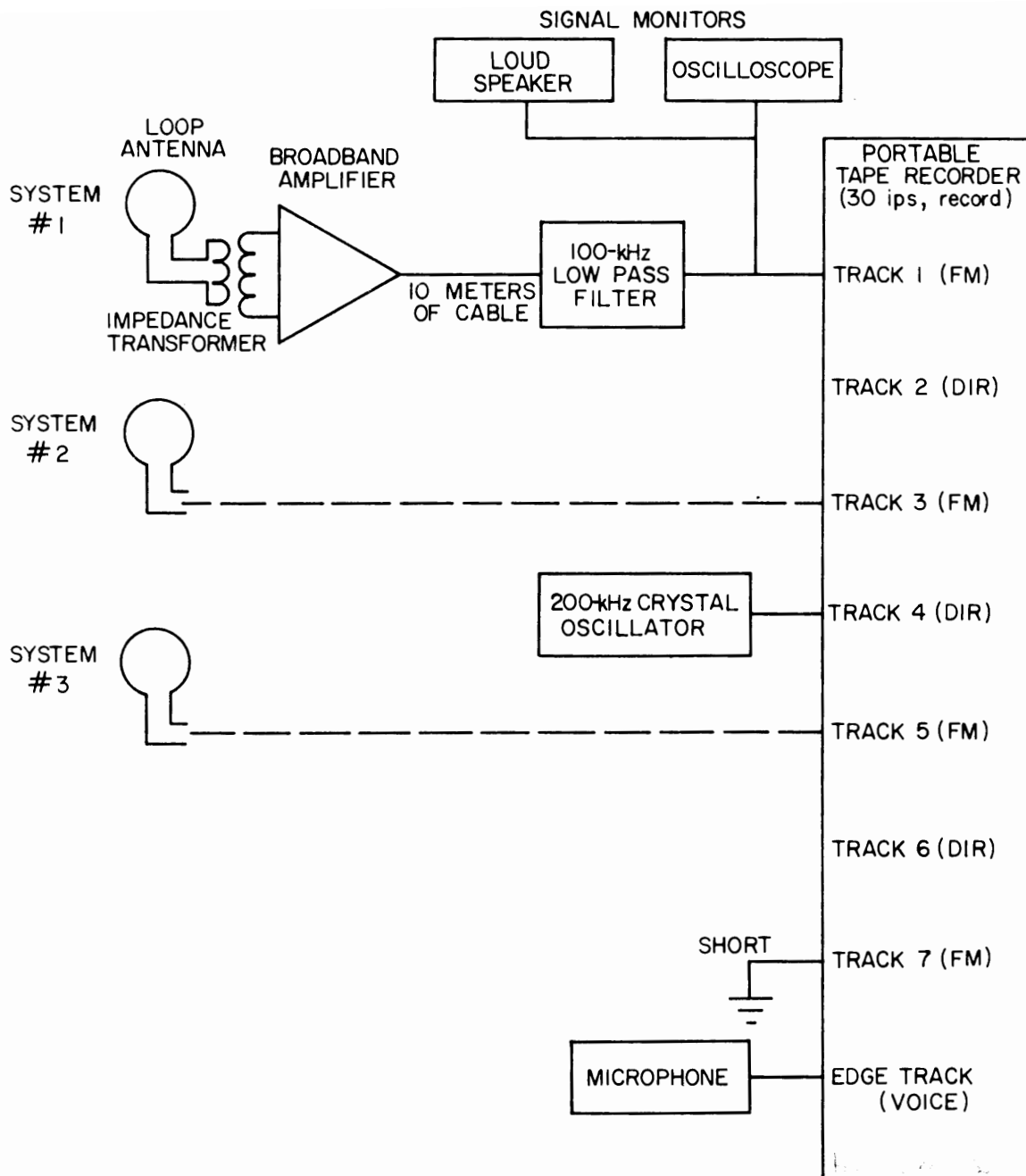

Figure 2-1 Block diagram of portable instrumentation, first system. FM tracks are used to record from 100 Hz to 100 kHz; direct tracks are used from 3 kHz to 320 kHz. Systems 2 and 3 are identical to system 1. When the direct tracks are used, the 100-kHz low pass filters are eliminated, and the amplifier bandwidth is increased from 100 kHz to 300 kHz. The microphone is used for occasional vocal comments by the operator.

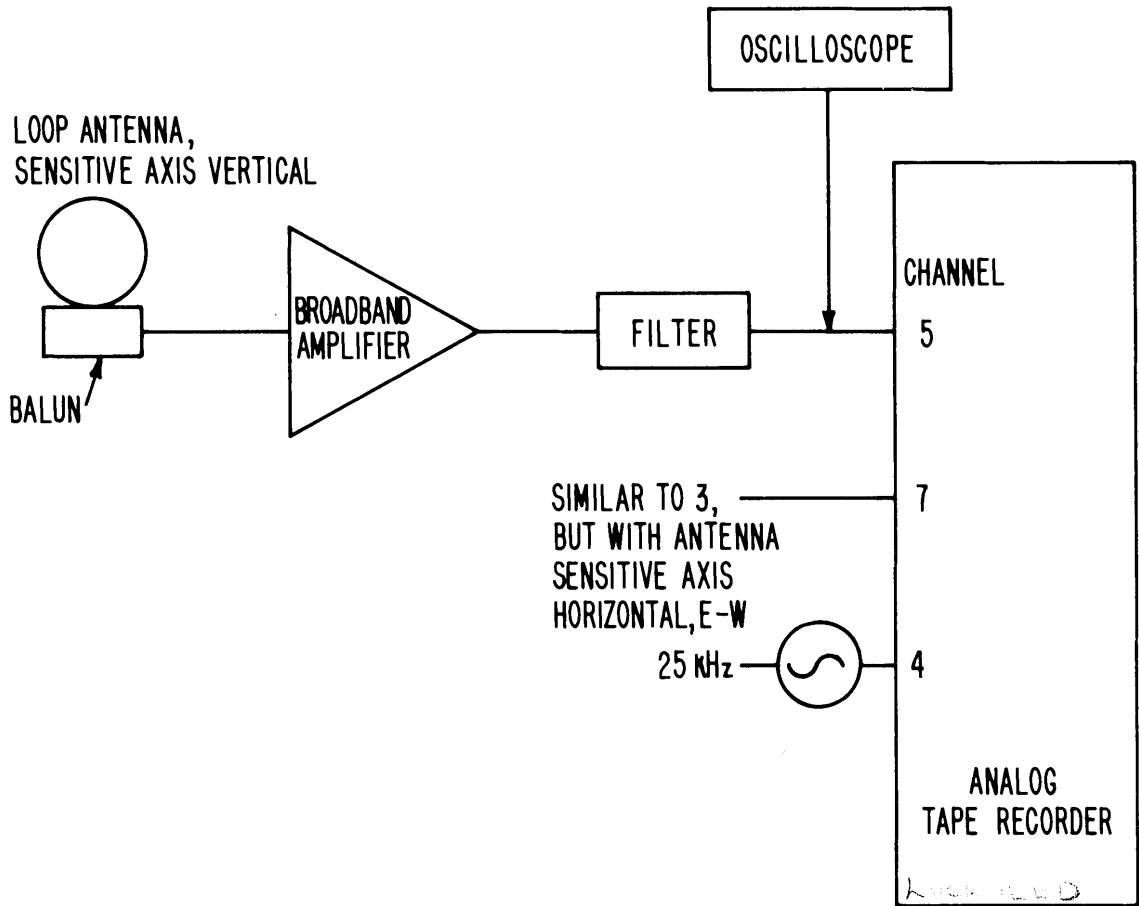

Figure 2-2 Second field recording system, first configuration.

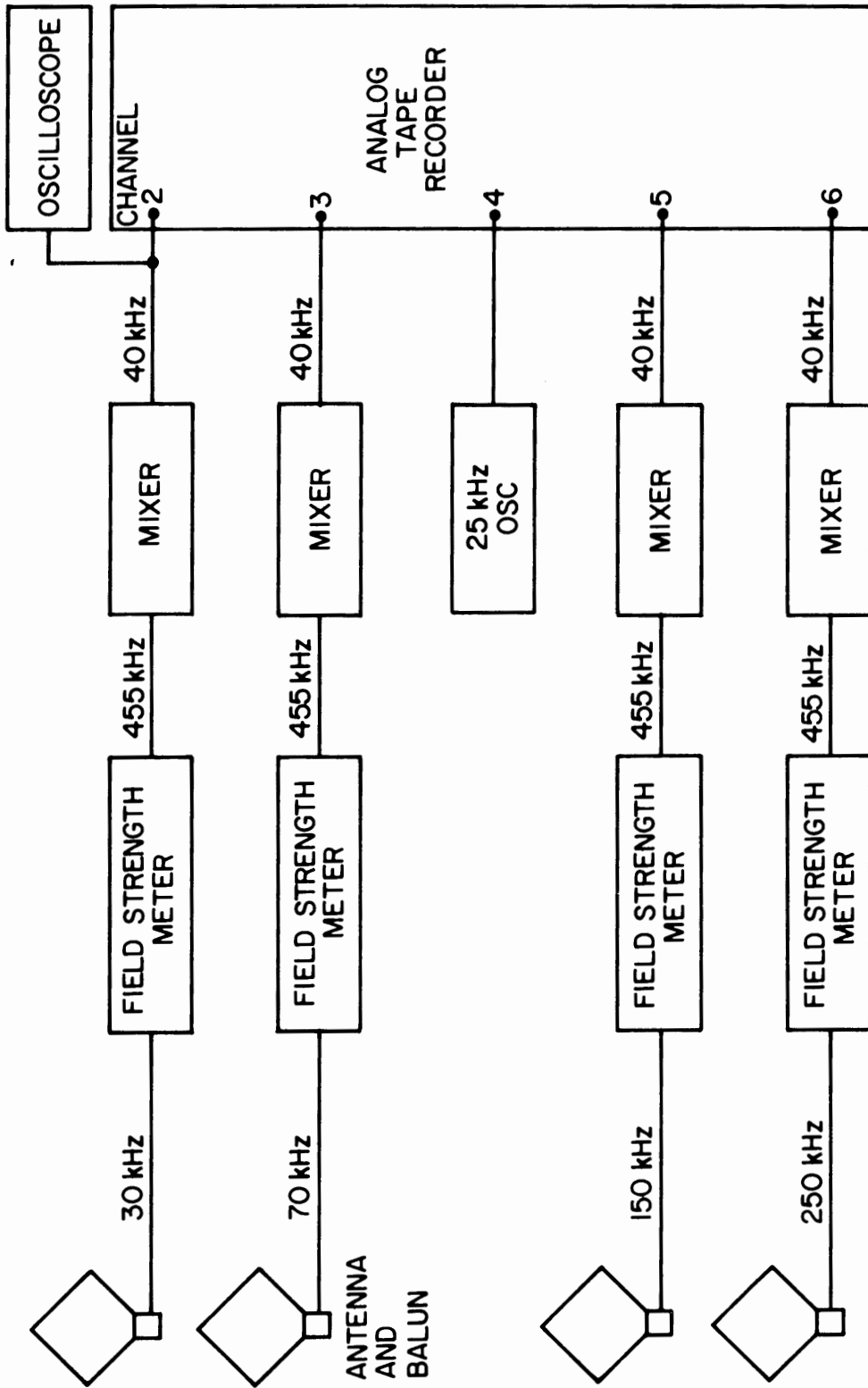

Figure 2-3 Second field recording system, second configuration; used to record data for APD's.

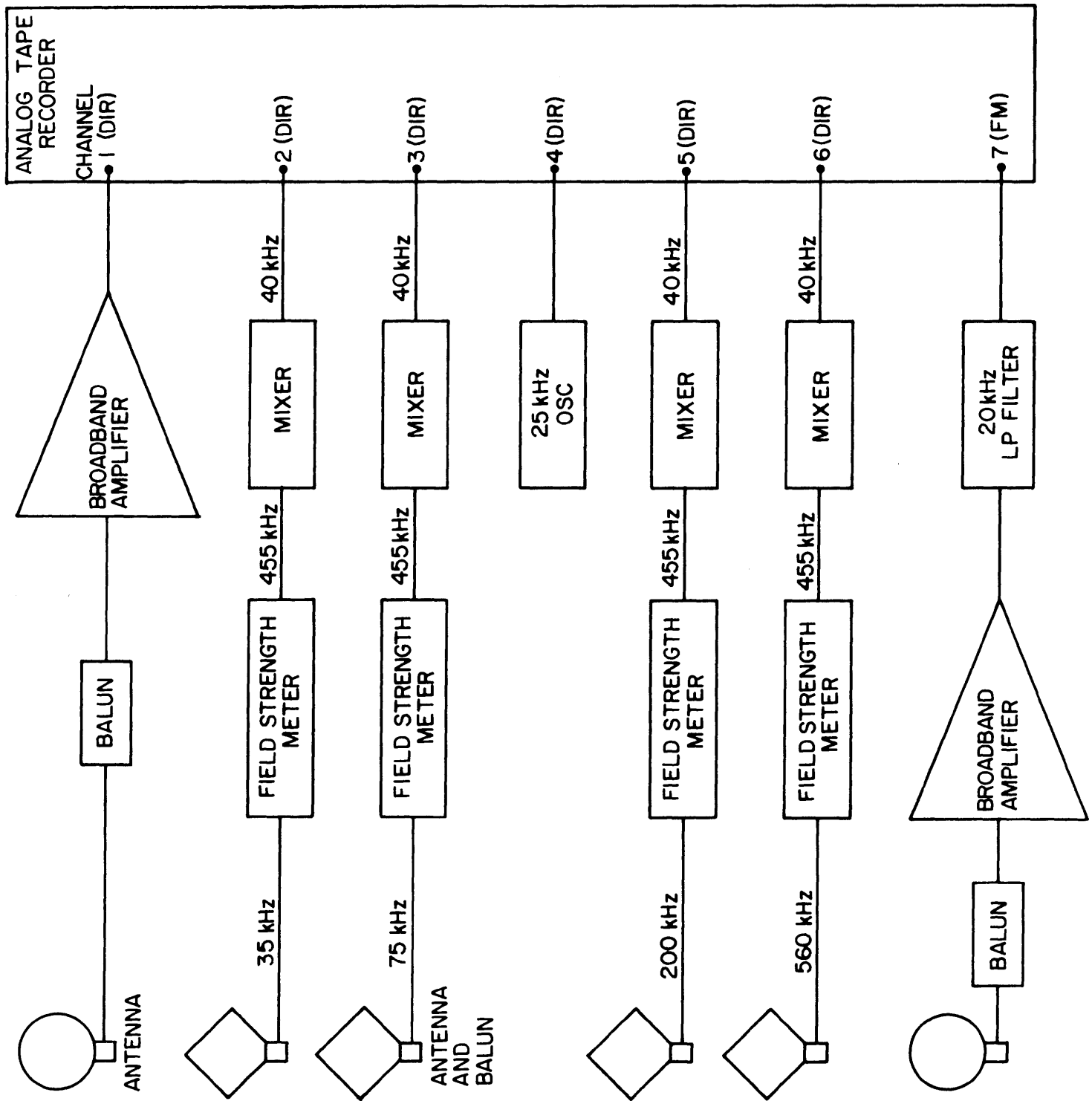

Figure 2-4 Second field recording system, third configuration; it recorded data for APD's on 3650 level.

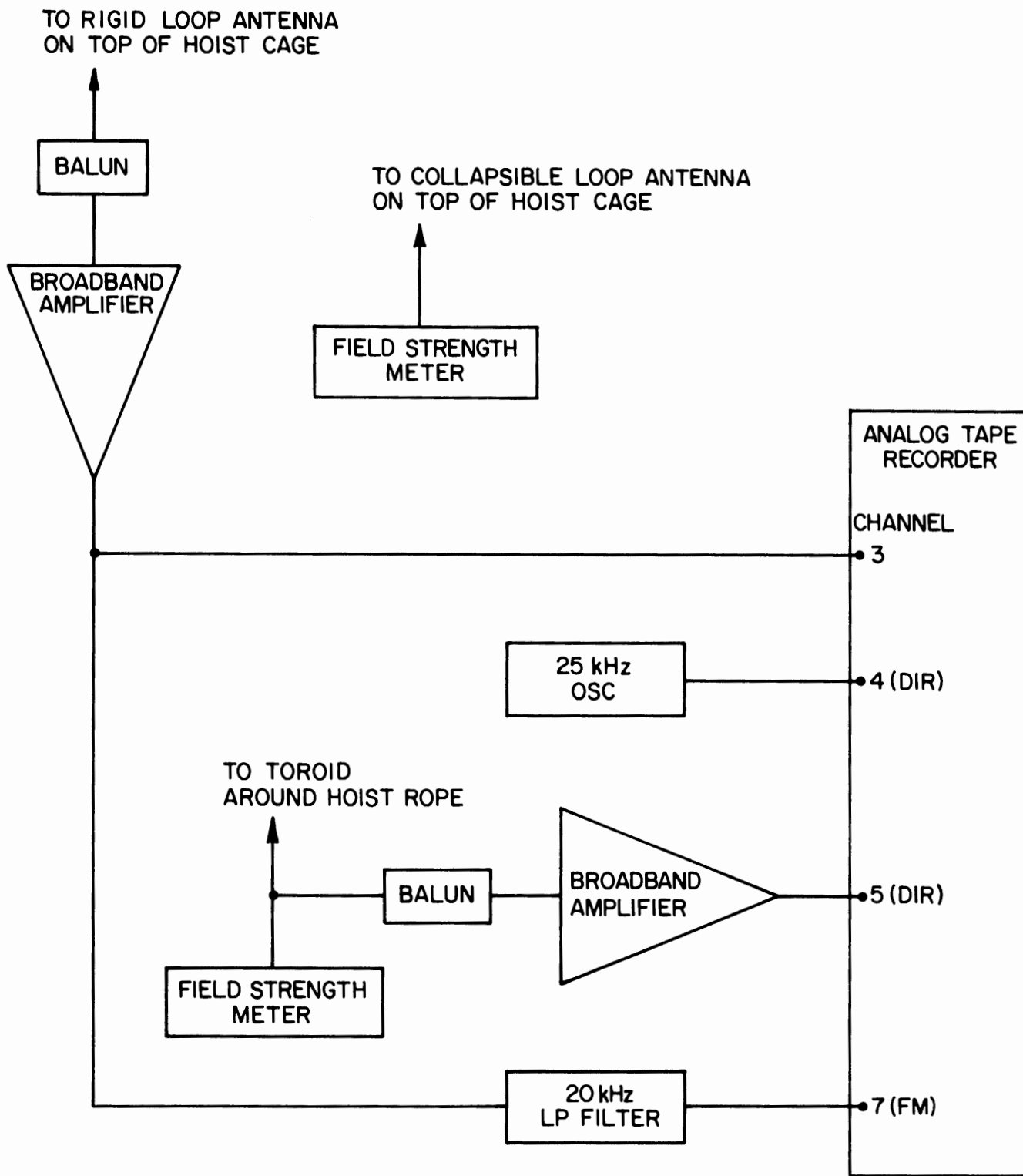

Figure 2-5 Second field recording system, fourth configuration; it was used on hoist runs up and down shaft.

3. SPECTRUM MEASUREMENT RESULTS

3.1 Introduction

In this section of the report, spectrum plots are presented and discussed. Most of these plots present magnetic field strength to either 100 kHz or 200 kHz. The curves to 100 kHz or less have an uncertainty of ± 1 dB. The curves to 200 kHz have an uncertainty of ± 2 dB from 3 kHz to 200 kHz. Measurements were made at many different locations and results can be used to characterize electromagnetic noise levels generated by most fixed and mobile equipment used in this mine.

3.2 Surface Noise Measurements

3.2.1 Hoist House

The hoist house contains a 1250 hp, direct current, double-drum hoist with dc current supplied by a motor-generator. Figures 3-1 and 3-2 show the noise measured in the hoist house. The antenna sensitive axis was vertical and about two meters from the electrical cables supplying the dc current to the hoist motor. The cables were below the concrete floor. For figure 3-1 the hoist was lifting a load (8.2 metric tons) of waste rock at 1300 feet/minute (396 m/min.), and for figure 3-2 at 1700 feet/minute (518 m/min.). This noise is one of the higher levels measured at Lucky Friday. Figures 3-1 and 3-2 are typical of several spectra taken in the hoist house, on Monday, August 27, 1973, a typical working day at the mine. This group of spectra (including figures 3-1 and 3-2) differs from other spectra taken around other machinery in that (1) noise in figure 3-2 is not dominated by powerline harmonics, (2) there are no obvious

commutator-produced spectral lines, which might normally be expected to occur around dc commutated machinery, (3) the spectral lines at 300 Hz and 925 Hz are the only lines that appear regularly; also, they are not harmonically related, and (4) other lines at non-harmonically related frequencies appear irregularly. The line at 1090 Hz is typical; it appears only in the spectrum shown in figure 3-2 and in none of the other spectra taken in the hoist house. Note that on figure 3-1, the spectrum has a minor increase centered around 19 kHz. Later in this report, other spectra taken elsewhere will show a similar increase. The inference will be drawn that the hoist house noise is propagating down the 1 1/2 inch (3.8 cm) steel hoist cable (rope) to some extent.

3.2.2 Head Frame

The head frame was 75 m away and uphill 40 m from the hoist house. The steel head frame stood about 20 meters high and supported two large sheaves, which in turn supported wire ropes, one each for the north and south shafts. Figures 3-3 and 3-4 show the noise measured on the surface 0.7 m from the open north shaft, with the antenna sensitive axis horizontal EW (pointed toward the wire rope). These measurements were made on August 27, 1973, a typical working day. The minor increase at 19 kHz seen in the hoist house does not show up here; however, it may have been masked by a sferic impulse. The same type of noise as heard on the audio monitor in the hoist house could also be heard at the head frame. However, at the head frame, there was a regular periodicity to the noise that probably can be correlated to the rotation of the main hoist drum. Finally, figure 3-3 shows the 18.6 kHz signal from the Navy Jim Creek transmitter, NLK Washington.

Spectra of three components of magnetic field noise at the head frame are shown in figures 3-5, 3-6, and 3-7. The noise levels are much lower than might be expected near operating machinery. Either distant sferics or arcs from the hoist house (where dc motors were operating) raise the noise levels slightly and in unpredictable ways. This is shown in figures 3-8, 3-9, and 3-10. The two hoist ropes leading from the hoist house to the head-frame serve as two-wire transmission lines, but the increase or decrease in impulsive noise does not seem to be related to rope movement. Compare figures 3-9 and 3-8.

3.2.3 Noise Near Business District, Center of Town

Three components of surface noise were measured on the sidewalk along a row of buildings with "neon signs". This is representative of surface noise over a mine that is under a town or city. The noise was predominantly at 60 Hz or its odd harmonics, and was quite strong, approaching 90 dB above a microampere per meter at 300 Hz, and 80 dB above a microampere per meter at 180 Hz. At frequencies above 2.5 kHz, all harmonics were of nearly equal amplitude. Valleys between the power line harmonics are about 40 dB above one $\mu\text{A}/\text{m}$ up to 2.5 kHz, but are down to 10 dB above one $\mu\text{A}/\text{m}$ from 5 to 10 kHz.

The vertical and horizontal (N-S) components of magnetic field strength were both strong, while the horizontal (E-W) component was about 20 to 30 dB lower. The component which is strongest or weakest will be different in each location depending principally on the direction(s) of the strongest source(s). The magnetic field noise spectra are shown in figures 3-11, 3-12, and 3-13.

3.3 Spectra at Levels Within the Mine

3.3.1 The 1450 Level

The levels within the mine are named by the depth, and correspond to the depth below the zero level in feet. The zero level is 40 meters below the headframe located on the surface. The depth in meters is obtained by multiplying the depth in feet by 0.3048 and adding 40 meters; the 1450 level is therefore 482 meters deep.

The 1450 level contained a 300 hp water pump. The motor used 67 amperes at 2300 V, three phase. Figures 3-14 and 3-15 show the noise measured at this level with the pump not operating. There is no longer any mining activity at this level. The measurement was made on Saturday, August 25, 1973, a non-working day in the mine. The antenna was one meter from the shaft with the sensitive axis horizontal N-S, tangent to the opening to the shaft. Figure 3-14 shows the same minor increase in the spectrum around 19 kHz that was noted in the hoist house. The noise, as heard on the audio monitor, had the characteristic sound of "grease-frying," but was too regular for atmospherics. The noise from the hoist house is similar to noise at the 1450 level. With the 300 hp pump turned on, the only change was a 20 dB increase in the 60 Hz noise.

While the teams from NBS were in the mine making noise measurements, another team from a communications firm was making rope transmission and impedance tests by injecting a single frequency signal into the north rope. The signal was coupled into the wire rope using a ferrite ring, and was nominally at a frequency of 50 kHz. Figure 3-14 shows a cw signal as it was received at the 1450 level. The frequency of this signal was 44.6 kHz, but this was not one of the

frequencies used in their tests. The transmitter might have been detuned at the time of our measurement, or there may have been some other source present. For example, see noise signals as shown in figure 3-49.

3.3.2 The 3650 Level

Noise measurements were made at a working level on February 8, 1974. Activity was very low at the time, so the noise levels measured may be somewhat lower than occur normally. A spectrum of the vertical component is shown in figure 3-16; a horizontal (N-S) component is shown in figure 3-17. Each covers time intervals during a transient of noise. Antenna location was about two meters east of the hoist doors. Figure 3-18 shows the spectrum of typical machine noise.

3.3.3 The 4050 Level

The 4050 level (1274 meters below the surface) was the deepest level at which normal mining was being carried on in August, 1973. The mine extended about a hundred meters lower to some mine development workings. The 4050 level contained a complex array of wires and switchboxes controlling pumps, fans, battery chargers, lights, etc. Figure 3-19 shows a plan view of the area near the shafts.

Figures 3-20 and 3-21 show the noise measured at location A (shown on figure 3-19) on Saturday, August 25, 1973, a non-working day in the mine. The antenna was 0.6 meters in front of the open shaft door, with sensitive axis horizontal N-S. Figure 3-20 shows the low noise level present at the 4050 level with most of the mine shut down. Figure 3-20 also shows what we believe is a strong test signal; the frequency was 48.6 kHz. It is significant that this test signal (if such it is) has penetrated the mine from the surface along metallic paths.

Figures 3-22 and 3-23 show the noise in the same location with the antenna sensitive axis vertical. At that time both the test signal and a 30 hp, 70 ampere, 440 volt water pump below the 4050 level were off. The next figures show spectral features that appear whenever this particular pump was operating. Figures 3-24 and 3-25 show the noise measured in the same location when the pump was operating. In figure 3-24 arrows indicate three spectral features that appear whenever the pump is operating. These features are the fundamental, second and third harmonic of 2.86 kHz. Because of their association with this pump, these features can be attributed to, and called, the signature of this water pump. Other spectra, not included in this report, occasionally show higher order harmonics. Figure 3-25 shows spectral lines (marked by arrows) above 2050 Hz, also from this water pump, that are separated by approximately 117.5 Hz instead of 120 Hz (the second harmonic of 60 Hz). Possibly the 117.5 Hz lines arise from the pump induction motor squirrel cage rotor "slipping." Induction motor rotors increasingly "slip" (i.e., run slower than the synchronous electrical rotation of the field) as the mechanical load is increased. These and other spectra in this report show harmonic structure that could probably be traced to other rotating machinery.

With the antenna in the above position (sensitive axis vertical, 0.6 m in front of the open south shaft door), during lunch, the 48.6 kHz (nominally 50 kHz) signal was transmitting into the north rope, with the north cage at the zero level (40 m below the surface). Measurement results at the 4050 level showed a 48.6 kHz signal strength of -12 dB relative to 1 μ A/m for the south cage at the bottom of the shaft (about 50 meters below the 4050 level), 0 dB re 1 μ A/m for the cage

at the 4050 level, -16 dB re 1 μ A/m for the cage 6 meters above the 4050 level, and -15 dB for the cage 40 meters above the 4050 level. A possible explanation for these results is that the cage acts as a moving transmission line termination. When the cage is at the 4050 level, the antenna picks up the current in the termination.

Figures 3-26 and 3-27 show the noise measured at location B in figure 3-19. The antenna was then 10 meters away from the north shaft with the sensitive axis vertical. A large number of harmonically related spectral lines can be seen from 1 kHz to 15 kHz on figure 3-26. These lines are generally present on most spectra taken while at this level. The lines arising from the water pump previously pointed out in figure 3-24 appear here also and are marked by arrows. The noise at 4.2, 8.4, 11.2 and 14.2 kHz also appears on the spectra taken with the antenna axis horizontal N-S. For the horizontal orientation, the noise is about the same at the upper three frequencies mentioned, and is as much as 12 dB lower at other frequencies.

Three large fans, one 20 hp, and two 40 hp, 440 volt three phase, were turned on and spectra were taken. The spectra are not shown, as very little difference in the magnetic noise was noted. The noise at 8.6 kHz on figure 3-26 was 6 dB higher. These fans were acoustically very noisy. A fourth 20 hp fan remained operating at all times at a level below 4050 (possibly accounting for some of the 8.6 kHz noise in figure 3-26).

Measurements made at 4050 with the cage ascending or descending showed a series of weak impulses, probably originating in the hoist house. At the 4050 level they were not a serious problem.

Figures 3-28 and 3-29 were taken with two rotary battery chargers operating, 4 meters distant from antenna location B. One of the battery chargers was relatively quiet, while the other contributed almost all the noise observed in the two spectra. This battery charger was the noisiest piece of equipment encountered at the 4050 level. Figure 3-29 shows a fine structure to the noise spectrum, with lines separated by about 28 Hz.

The mine used 5-ton, 90 cell, battery-operated electric locomotives. The battery chargers mentioned above were used for recharging these locomotive batteries. Spectra taken with the antenna at location B while the locomotive was running back and forth across the ore dump produced no measurable spectral lines. An impulse was received every time the locomotive motor contactor engaged or disengaged. In an attempt to determine the effective noise field near a cap-mounted receiver worn by the locomotive operator, spectra were taken with the antenna around the operator, sensitive axis vertical, while the locomotive was operating. Figures 3-30 and 3-31 show the resultant spectra. Figure 3-30 looks like noise received from the hoist house. Listening to the audio monitor during this recording reveals a low frequency, low amplitude commutator brush-noise whenever the battery was connected to the motor and the locomotive was accelerating. Note the strength of the 48.6 kHz test signal. Figure 3-31 shows an impulse that has been produced by the locomotive. The impulse is as much as 30 dB above the steady mine power-line harmonics and is at least 50 dB above background levels between 100 Hz and 1000 Hz.

At the 4050 level, measurements were made close to the working face area, at an area known as the "Y of 99 and 95Y." This location was a hundred meters or so from the shaft area.

There was no mining activity in progress (measurements were made on Saturday). Figure 3-32 shows the spectrum obtained with the antenna axis horizontal, perpendicular to the drift, and the tracks in the drift. The 4.2 and 8.4 kHz noise, as previously seen in figure 3-26, appear clearly here also. The spectrum taken with the antenna axis vertical showed about 6 dB less noise than figure 3-32. For the antenna axis horizontal and parallel to the tracks, the noise was below the measurement system noise. Figure 3-33 shows the expanded spectrum measured with the antenna axis vertical. Transients were still in evidence at this location, possibly from the hoist.

At this location near the face, it was clear that the source of noise was primarily the two steel rails, and secondarily, any other metal pipe in the drift. To demonstrate this, a measurement was taken with the antenna directly adjacent to one of the rails. Figures 3-34 and 3-35 show the result. Immediately apparent on figure 3-34 is the very strong 48.6 kHz test signal inserted on the north rope at the surface with a few watts of power.

3.4 Spectra Obtained from Cage Runs, Loop Antenna

3.4.1 Mine Not in Operation

To measure the fields on top of the cage as it traveled the entire length of the shaft, a loop antenna was secured to the top of the cage, next to the supporting hoist rope and associated hardware. Because of the proximity of this rope, levels of fields measured are not accurate field strength values, but due to close coupling between antenna and hoist rope, the values do reflect (on a relative basis) current levels in the hoist rope.

On Saturday, August 25, 1973, the mine was not in operation. Figure 3-36 shows the noise measured at the zero level, and figure 3-37 shows the noise measured at the 4050 level. The noise levels shown are relatively low, and contain the minor increase around 19 kHz which as previously noted, probably comes from the hoist motor.

3.4.2 Mine in Operation

On Monday, August 27, 1973, when the mine was in full operation, the measurement of fields on top of the cage was repeated. Figure 3-38 shows the spectrum taken with the cage stationary before starting down. Figure 3-39 shows the spectrum just after starting down. Figure 3-40 shows the spectrum at about 470 meters of depth. Figure 3-41 shows the spectrum at about 1080 meters of depth. Immediately apparent from the last four figures is the presence of a severe noise source that was not present on Saturday when the mine was not operating. This noise is from an unknown source and seemed to increase with depth. Figure 3-41 is the last spectrum taken before the recording equipment saturated. The signal monitors indicated the noise source was at or below the 4050 level. Laboratory replay of the analog recordings showed that this noise has the following characteristics:

- (1) The noise is made up of groups of about 4 to 8 individual impulses.
- (2) The groups of impulses occur 120 times per second.
- (3) The impulses within a group are not time synchronized.
- (4) Alternating groups appear to have some similarity.

From the above characteristics, we speculate that this noise source is an arc of some sort and is produced by 60 Hz single phase, ac voltage.

On a second visit to this mine on February 8, 1974, this same type of noise was received. Gains were set low enough that saturation of the measurement system was avoided. The spectra are similar in shape, and in the following figures, absolute levels can be determined. This unknown source causes noise many orders of magnitude stronger than any other source of interference in this mine. It is not a transient, but lasts seconds or minutes, and hence must be considered as intermittent. Spectra are shown in figure 3-42 as recorded from a loop antenna on top of a hoist cage. Another spectrum of the same noise from the output of a ferrite loop around the hoist rope into a 50-ohm load is shown in figure 3-43. The spectral distribution varies with time as is shown by comparing figure 3-44 with 3-42.

This source raises the noise level at least 40 to 60 dB above background noise as shown in figure 3-45 over a wide frequency range (50-100 kHz); figure 3-46 shows this noise signal to be above system noise from 10 kHz to 200 kHz. Transient events such as shown in figures 3-47, 3-48, and 3-49 are also present, but only for relatively short durations of time. Figure 3-50 shows a 20 kHz spectrum; it may indicate a ground station at 18.6 kHz, but at the 1800 foot level, this is doubtful.

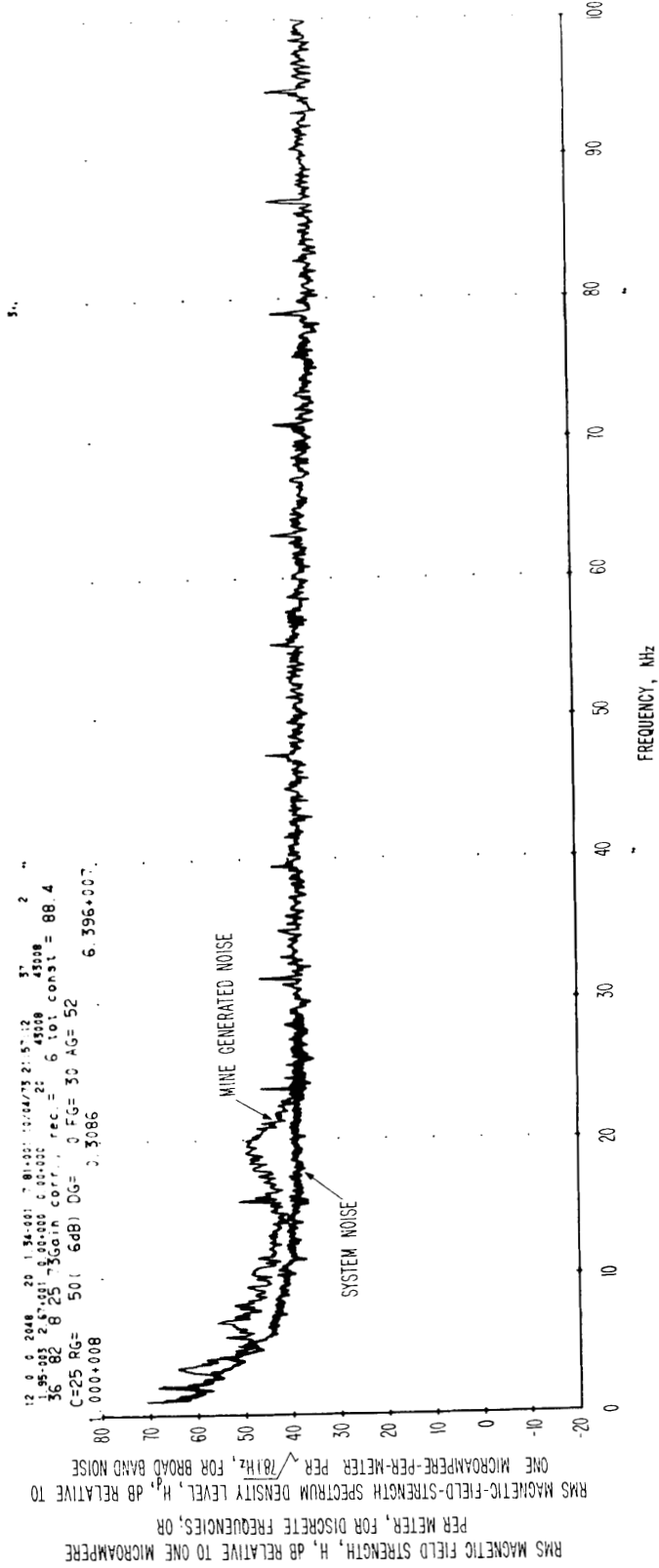

Figure 3-1 Spectrum of magnetic field strength obtained on a loop antenna 1 kHz to 100 kHz, Lucky Friday Mine, located at hoist house, two meters from motor cables, hoisting waste rock, antenna sensitive axis vertical, 9:30 a.m., August 27, 1973. Spectral resolution is 78.1 Hz.

12 0 0 2048 20 2.69+000 3.91+000 05/04/74 23:59:11 55 267 *
 1.95-003 -2.79+001 0.00+000 0.00+000 20 43008 43008
 54 118 8 25 74Gain corr., rec.= 6 tot const.= 88.4
 C=42 RG= 50 (6dB) DG= 0 FG= 30 AG= 52
 .000+013 0.3086 2.617+012.

RMS MAGNETIC FIELD STRENGTH, H, DB RELATIVE TO ONE MICROAMPERE PER METER, FOR DISCRETE FREQUENCIES; OR
 RMS MAGNETIC-FIELD-STRENGTH SPECTRUM DENSITY LEVEL, H_p, DB RELATIVE TO ONE MICROAMPERE-PER-METER PER $\sqrt{3.91}$ Hz, FOR BROAD BAND NOISE

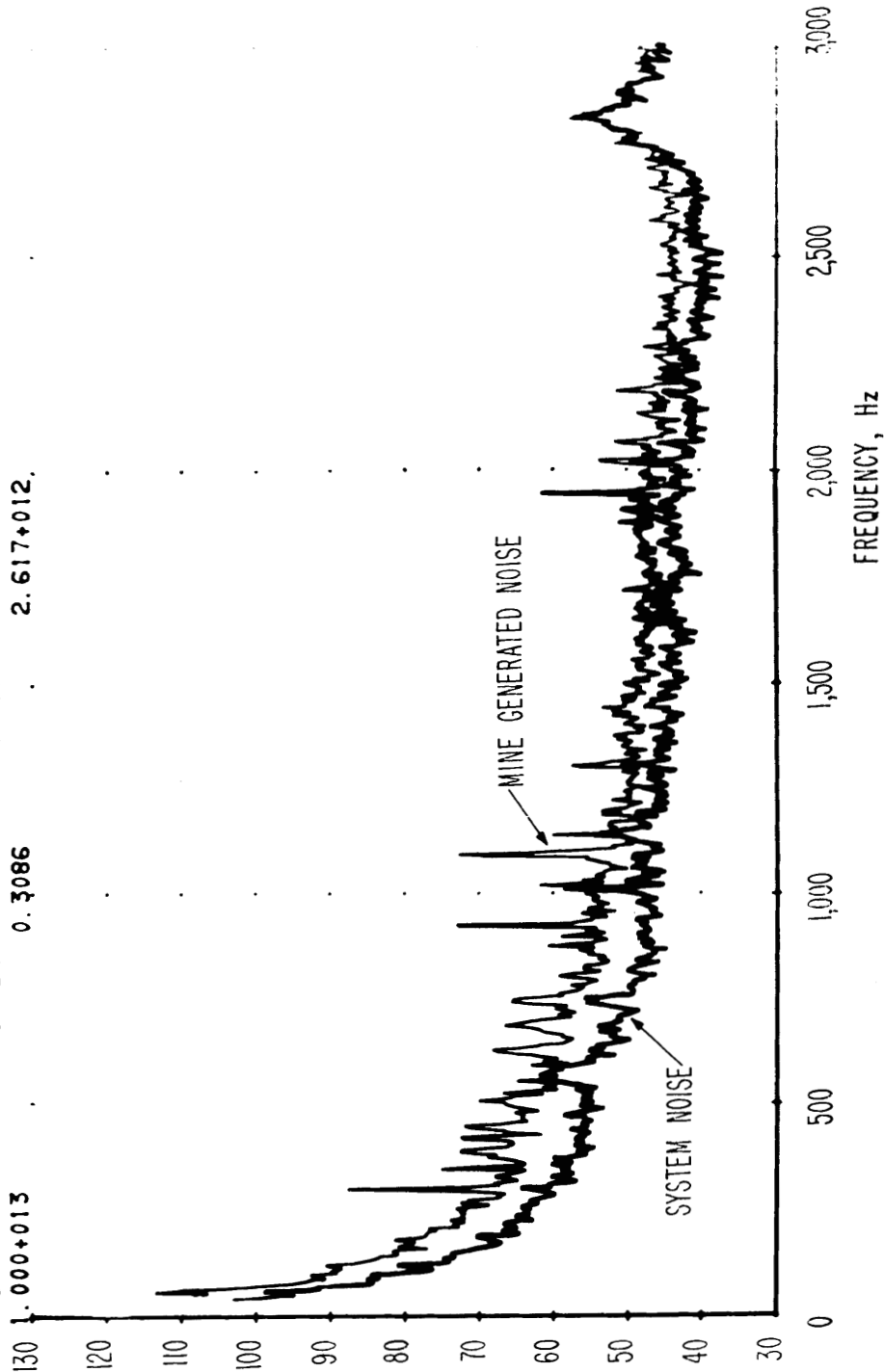

Figure 3-2 Spectrum of magnetic field strength obtained on a loop antenna 40 Hz to 3 kHz, Lucky Friday Mine, located at hoist house, two meters from motor cables, hoisting waste rock at full speed, antenna sensitive axis vertical, 9:54 a.m., August 27, 1973. Spectral resolution is 3.91 Hz.

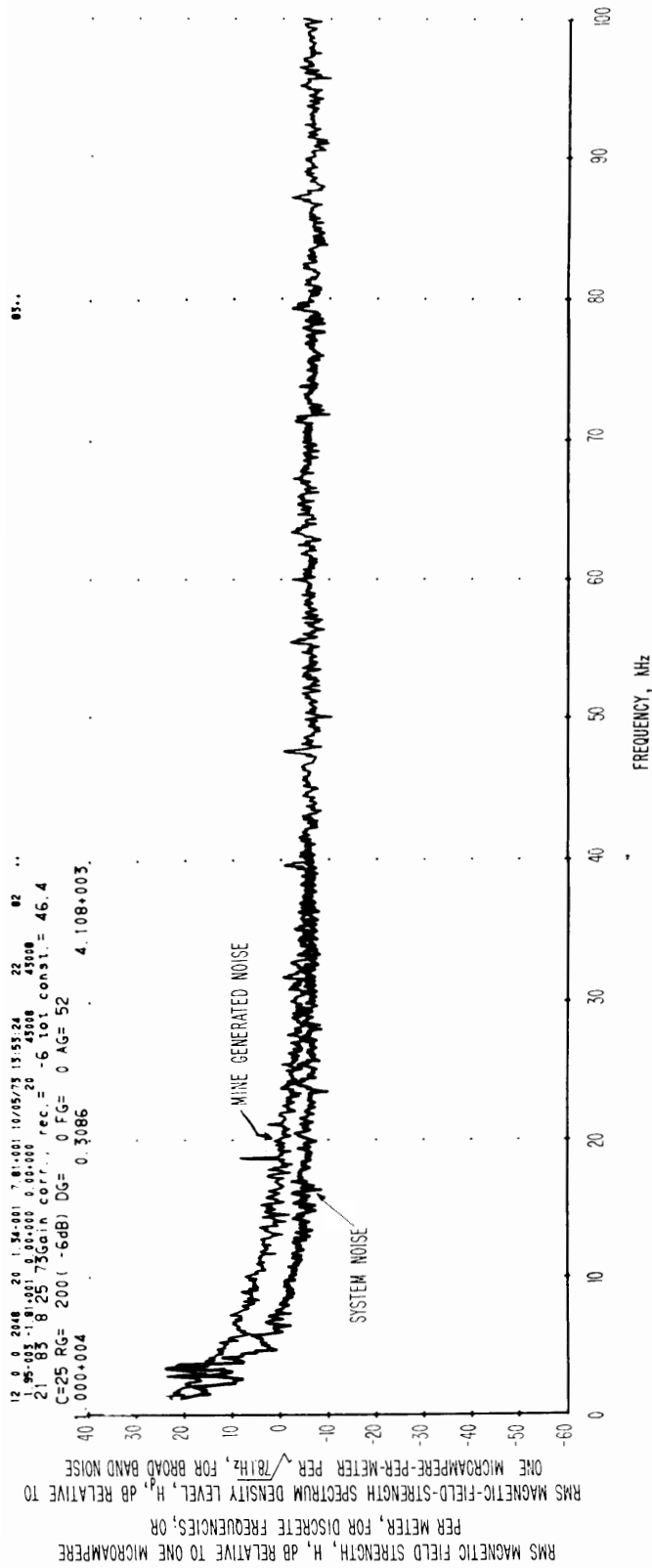

Figure 3-3 Spectrum of magnetic field strength obtained on a loop antenna 1 kHz to 100 kHz, Lucky Friday Mine, at head frame by hoist cable operating at full speed, antenna sensitive axis horizontal, 11:02 a.m., August 27, 1973. Spectral resolution is 78.1 Hz.

12 0 0 2048 20 2.69+000 3.91+000 56724774 24:56:29 55 31.8
 1.95-003 -3.04+001 0.00+000 0.00+000 2: 43:08 43:06
 63 118 8 25 74Gain corr., rec. = -6 tot const. = 46.4
 C=42 RG= 200 (-6dB) DG= 0 FG= 0 AG= 52
 1.000+009 0.3086 1.800+008

RMS MAGNETIC FIELD STRENGTH, H, dB RELATIVE TO ONE MICROAMPERE
 PER METER, FOR DISCRETE FREQUENCIES; OR
 RMS MAGNETIC-FIELD-STRENGTH SPECTRUM DENSITY LEVEL, H, dB RELATIVE TO
 ONE MICROAMPERE-PER-METER PER $\sqrt{391}$ Hz, FOR BROAD BAND NOISE

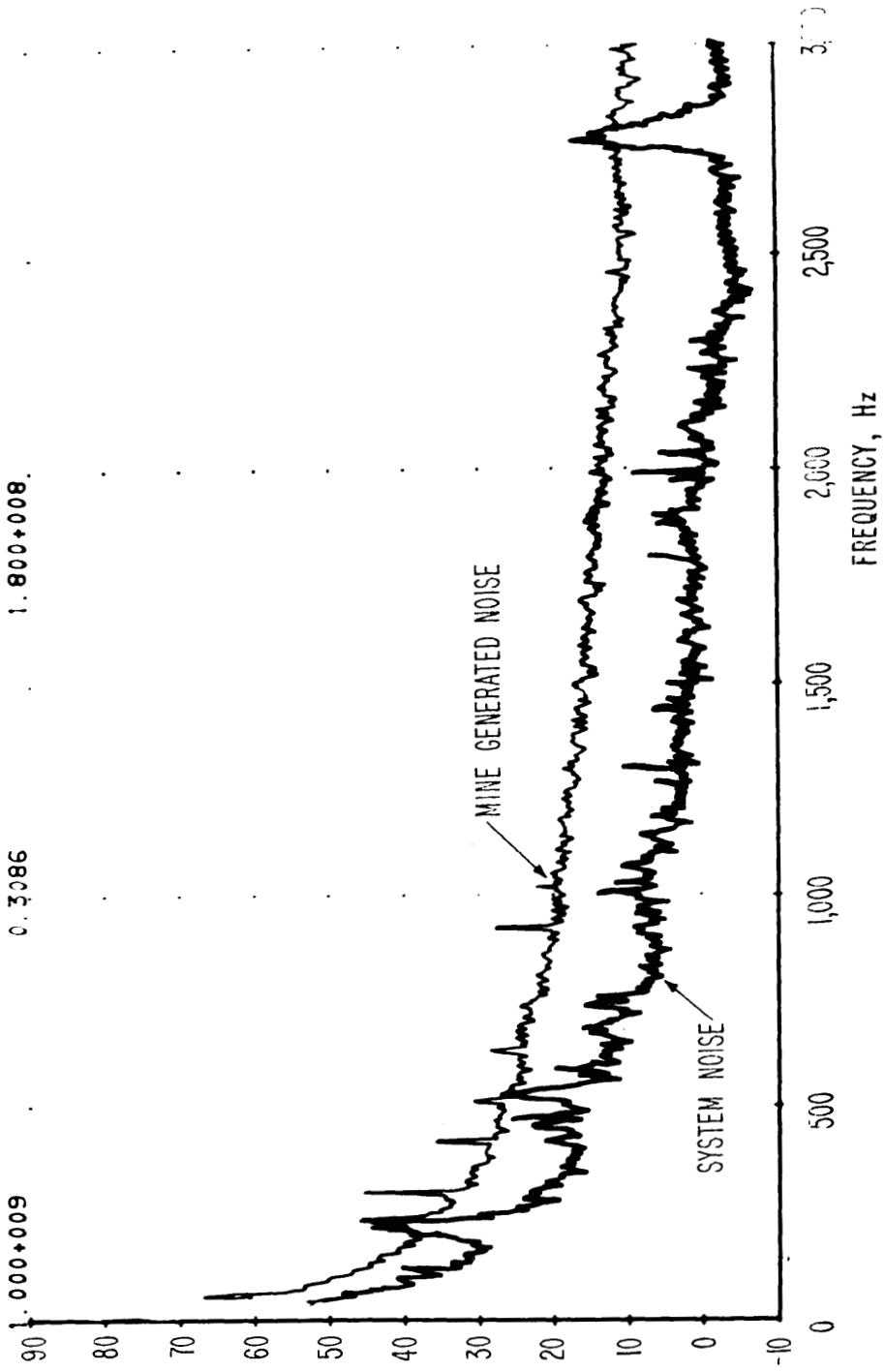

Figure 3-4 Spectrum of magnetic field strength obtained on a loop antenna 40 Hz to 3 kHz, Lucky Friday Mine, at head frame by hoist cable operating at full speed, antenna sensitive axis horizontal, 11:02 a.m., August 27, 1973. Spectral resolution is 3.91 Hz.

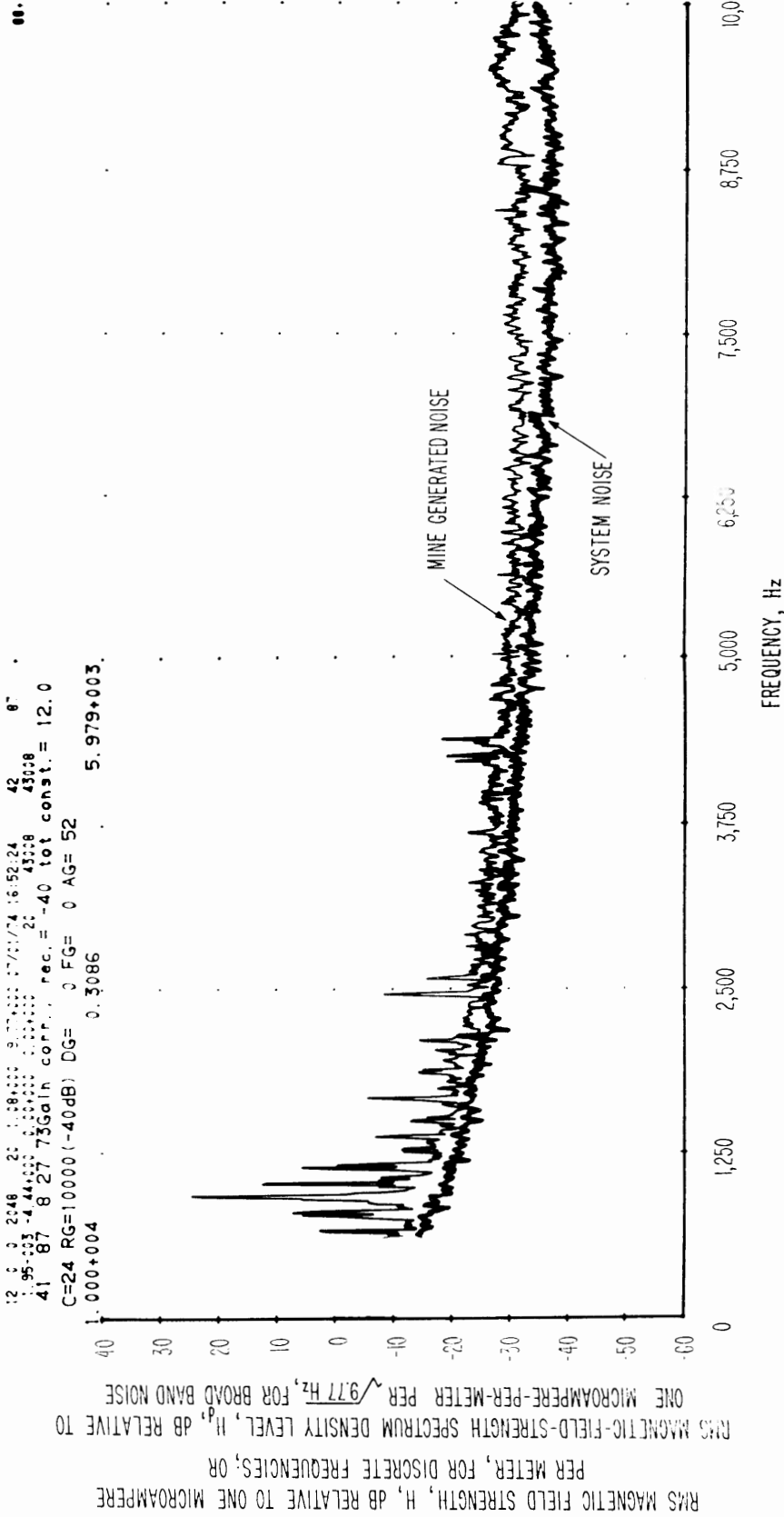

Figure 3-5 Spectrum of magnetic field strength obtained from a loop antenna, sensitive axis vertical, frequency range 560 Hz to 10 kHz, located at the headframe of the Lucky Friday Mine, about 9:00 a.m., August 27, 1974.

12 5 2:48 20 1.58000 9.07000 07:17:4 16:46:59 35 52
 1.95-003 1.23000 5.00000 20 43:08 43:08
 34 87 8 27.75Gain corr., rec. = -40 tot const. = 12.0
 C=24 RG=10000 (-40dB) DG= 0 FG= 0 AG= 52
 1.000+005 0.3086 6.345+004.

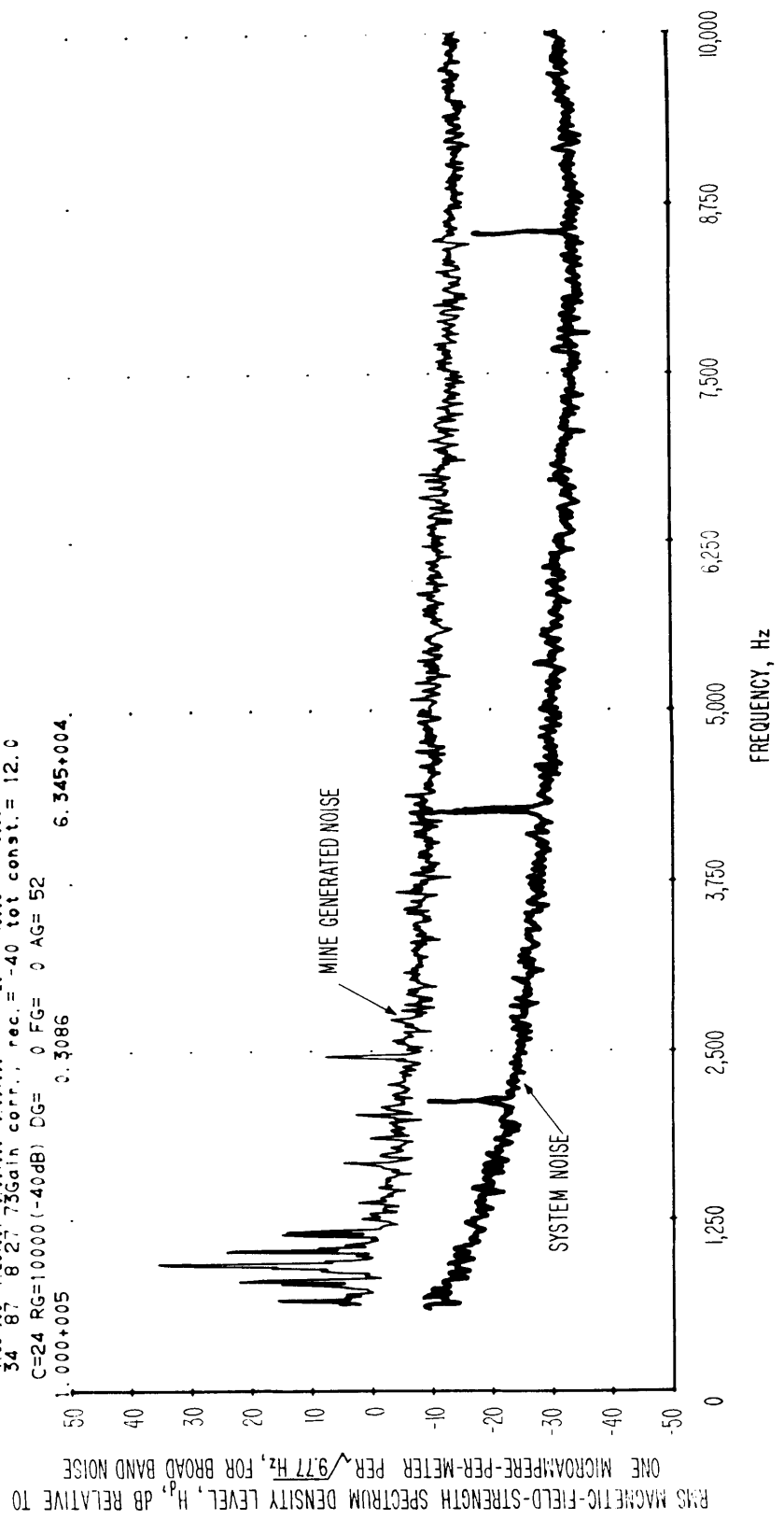

Figure 3-6 Spectrum of magnetic field strength obtained from a loop antenna, sensitive axis horizontal (North-South), frequency range 560 Hz to 10 kHz, located at the headframe of the Lucky Friday Mine, about 8:55 a.m., August 27, 1974.

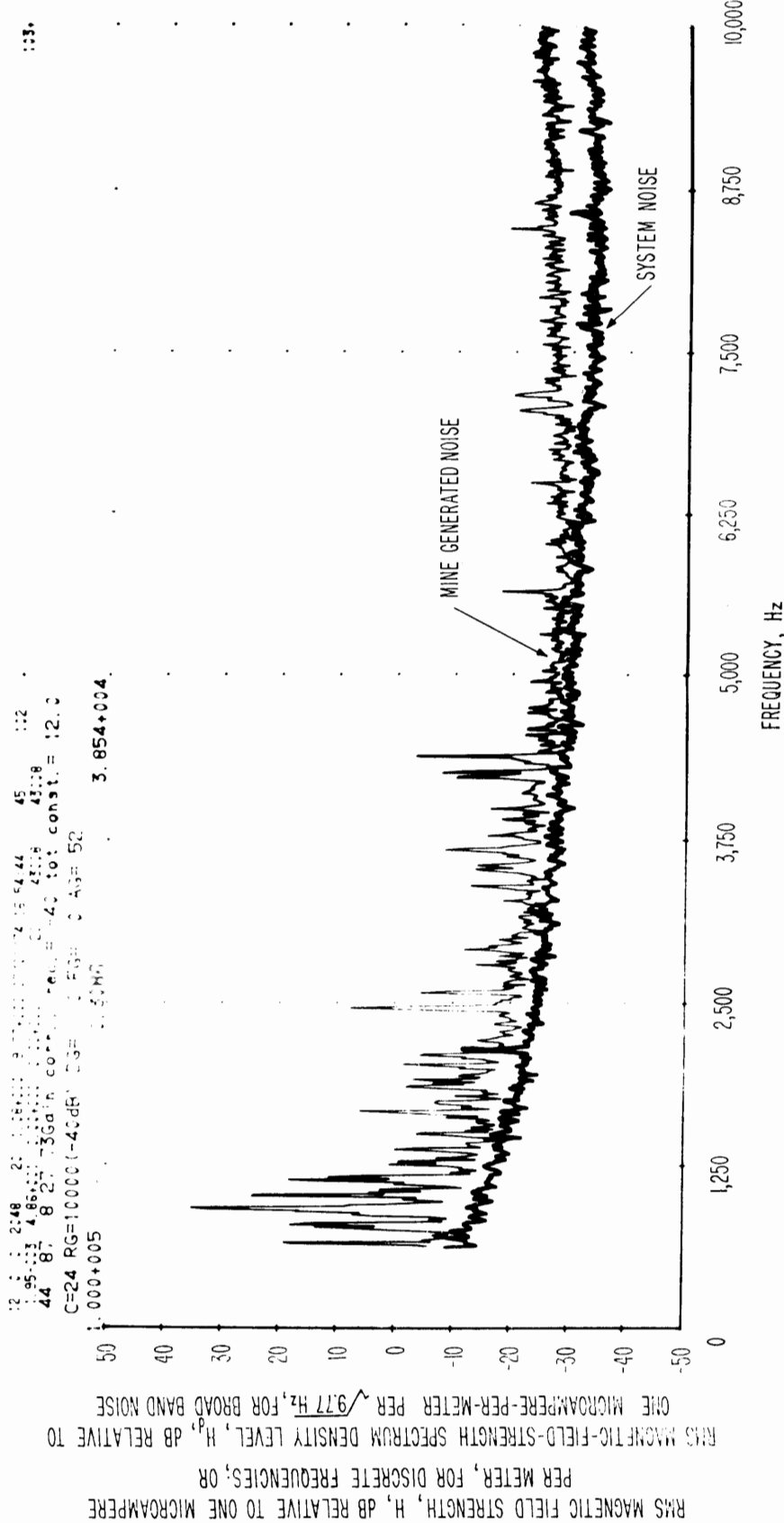

Figure 3-7 Spectrum of magnetic field strength obtained from a loop antenna, sensitive axis horizontal (East-West), frequency range 560 Hz to 10 kHz, located at the headframe of the Lucky Friday Mine, about 9:00 a.m., August 27, 1974.

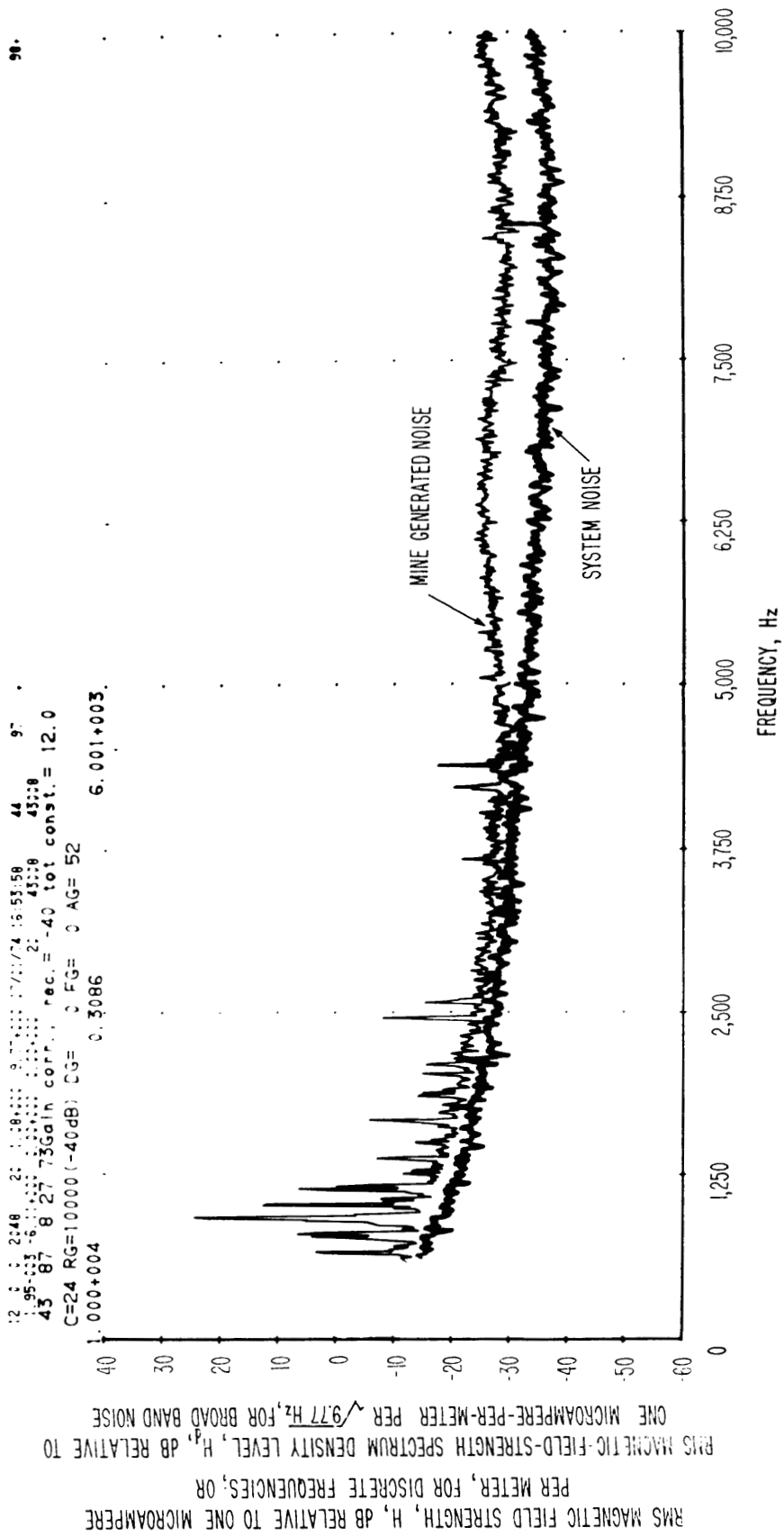

Figure 3-8 Spectrum of magnetic field strength obtained from a loop antenna, sensitive axis vertical, frequency range 560 Hz to 10 kHz, located at the headframe of the Lucky Friday Mine south rope moving down, about 9:00 a.m., August 27, 1974.

12 3 5 2048 20 1.50+000 9.77+000 57/01/74 16:52:51 45 77
 1.95+000 4.83+000 0.00+000 0.00+000 25 43308 43:08
 39 87 8 27 75Gain corr., rec. = -40 tot const. = 12.0
 C=24 RG=10000(-40dB) DG= 0 FG= 0 AG= 52
 L.000+004 0.308E 6.253+003.

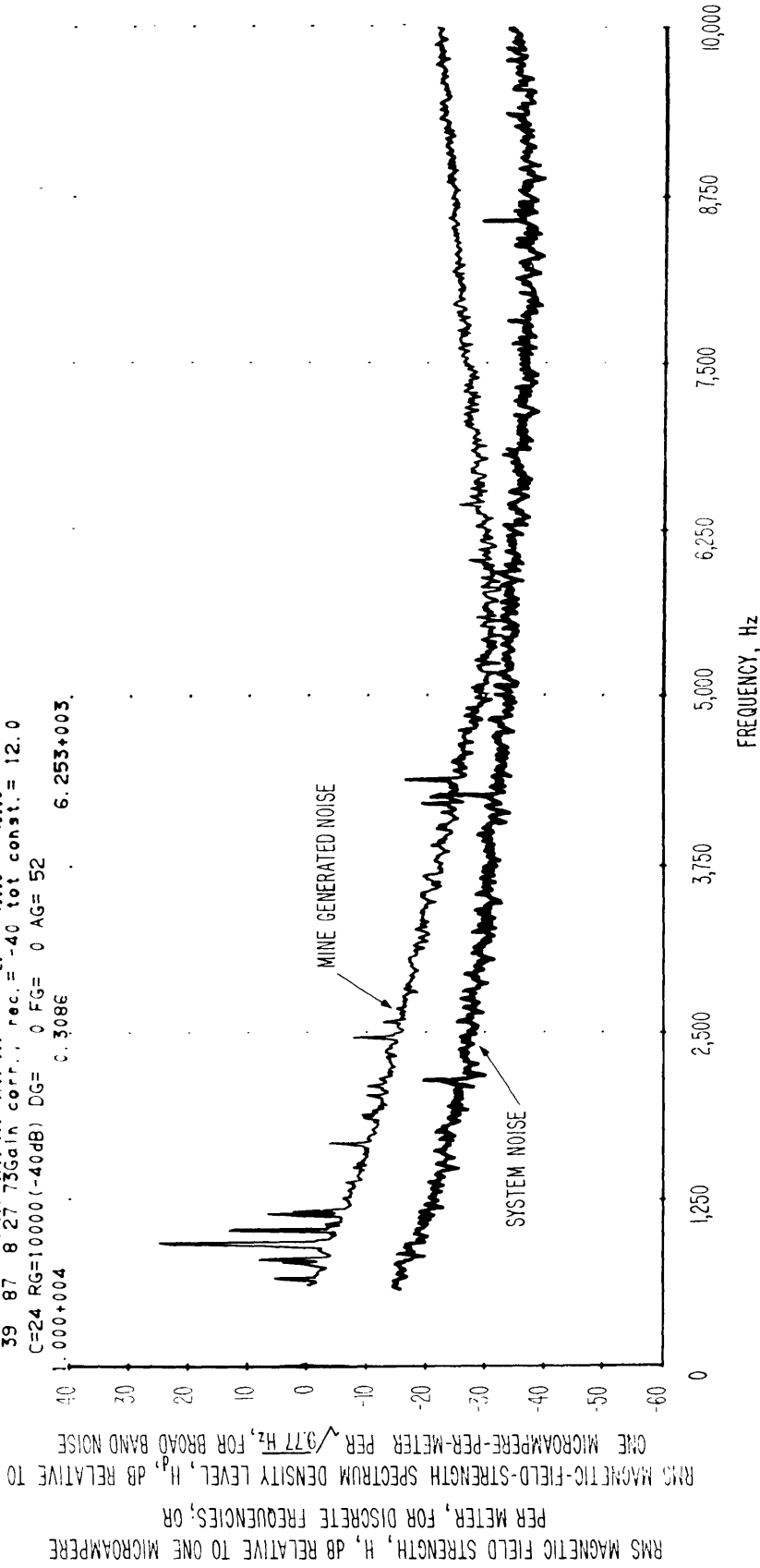

Figure 3-9 Spectrum of magnetic field strength obtained from a loop antenna, sensitive axis vertical, frequency range 560 Hz to 10 kHz, located at the headframe of the Lucky Friday Mine, ropes not moving, about 9:00 a.m., August 27, 1974.

12.5 2.48 20 1.58+000 9.77+000 17.00/74 16.53+000 43 92
 1.95+000 4.8+000 1.00+000 1.00+000 20 43+08 43+08
 42 8.7 8.27 75Gain corr., rec. = -40 tot const. = 12.0
 C=24 RG=10000(-40dB) CG= 0 FG= 0 AG= 52
 1.000+003 0.3086 2.798+002.

RMS MAGNETIC FIELD STRENGTH, H, dB RELATIVE TO ONE MICROAMPERE
 PER METER, FOR DISCRETE FREQUENCIES; OR
 RMS MAGNETIC-FIELD-STRENGTH SPECTRUM DENSITY LEVEL, H_p, dB RELATIVE TO
 ONE MICROAMPERE-PER-METER PER $\sqrt{9.77 \text{ Hz}}$, FOR BROAD BAND NOISE

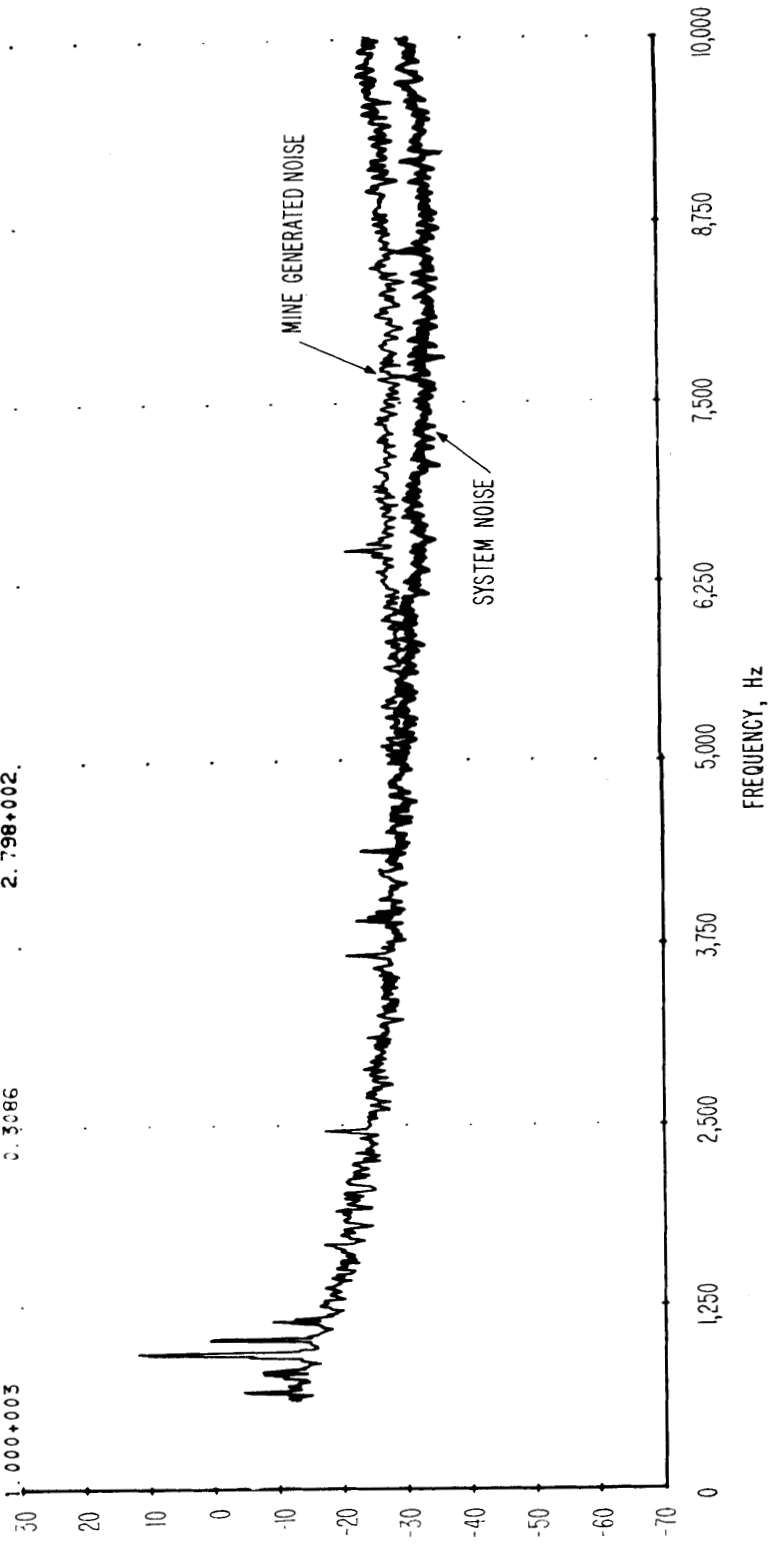

Figure 3-10 Spectrum of magnetic field strength obtained from a loop antenna, sensitive axis horizontal (East-West), frequency range 560 Hz to 10 kHz, located at the headframe of the Lucky Friday Mine, south rope moving down, about 9:00 a.m., August 27, 1974.

12 0 0 2048 20 1.08+000 9.77+000 07/01/74 16:44:38 32 37
 1.95+003 -2.55+001 0.00+000 0.00+000 20 43308
 31 87 8 26 75Gain corr., rec. = 0 tot const. = 52.0
 C=24 RG= 100(0dB) DG= 0 FG= 0 AG= 52
 1.000+009 0.3086 3.469+008.

RMS MAGNETIC FIELD STRENGTH, H, dB RELATIVE TO ONE MICROAMPERE PER METER, FOR DISCRETE FREQUENCIES, OR RMS MAGNETIC-FIELD-STRENGTH SPECTRUM DENSITY LEVEL, H, dB RELATIVE TO ONE MICROAMPERE-PER-METER PER $\sqrt{9.77 \text{ Hz}}$, FOR BROAD BAND NOISE

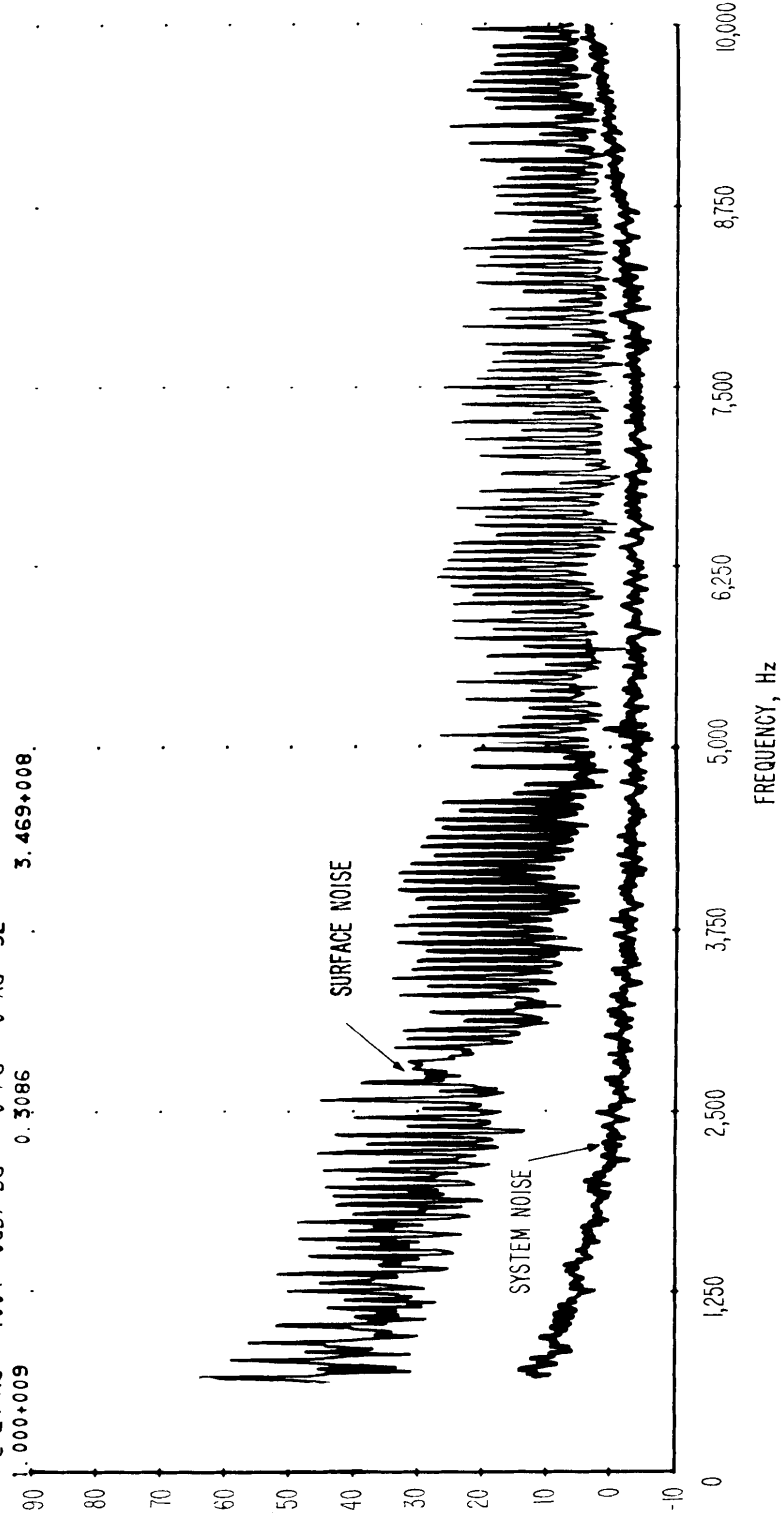

Figure 3-11 Spectrum of magnetic field strength obtained from a loop antenna, sensitive axis vertical, frequency range 560 Hz to 10 kHz, located on Cedar Street in Wallace, Idaho, about 6:00 p.m., August 26, 1974. Neon lights are about 10 meters distant.

12 6 2:48 20 1:58:000 9:77:000 07/21/74 16:43:51 31 32
 1.95-003 5.33+001 5:00:000 5:00:000 20 43:08 43:08
 30 87 8 26.73Gain corr., rec.= 0 tot const.= 52.0
 C=24 RG= 100 (0dB) DG= 0 FG= 0 AG= 52
 0.000+008 0.3086 8.818+007.

RMS MAGNETIC FIELD STRENGTH, H, DB RELATIVE TO ONE MICROAMPERE
 PER METER, FOR DISCRETE FREQUENCIES; OR
 RMS MAGNETIC-FIELD-STRENGTH SPECTRUM DENSITY LEVEL, H, DB RELATIVE TO
 ONE MICROAMPERE-PER-METER PER $\sqrt{9.77 \text{ Hz}}$, FOR BROAD BAND NOISE

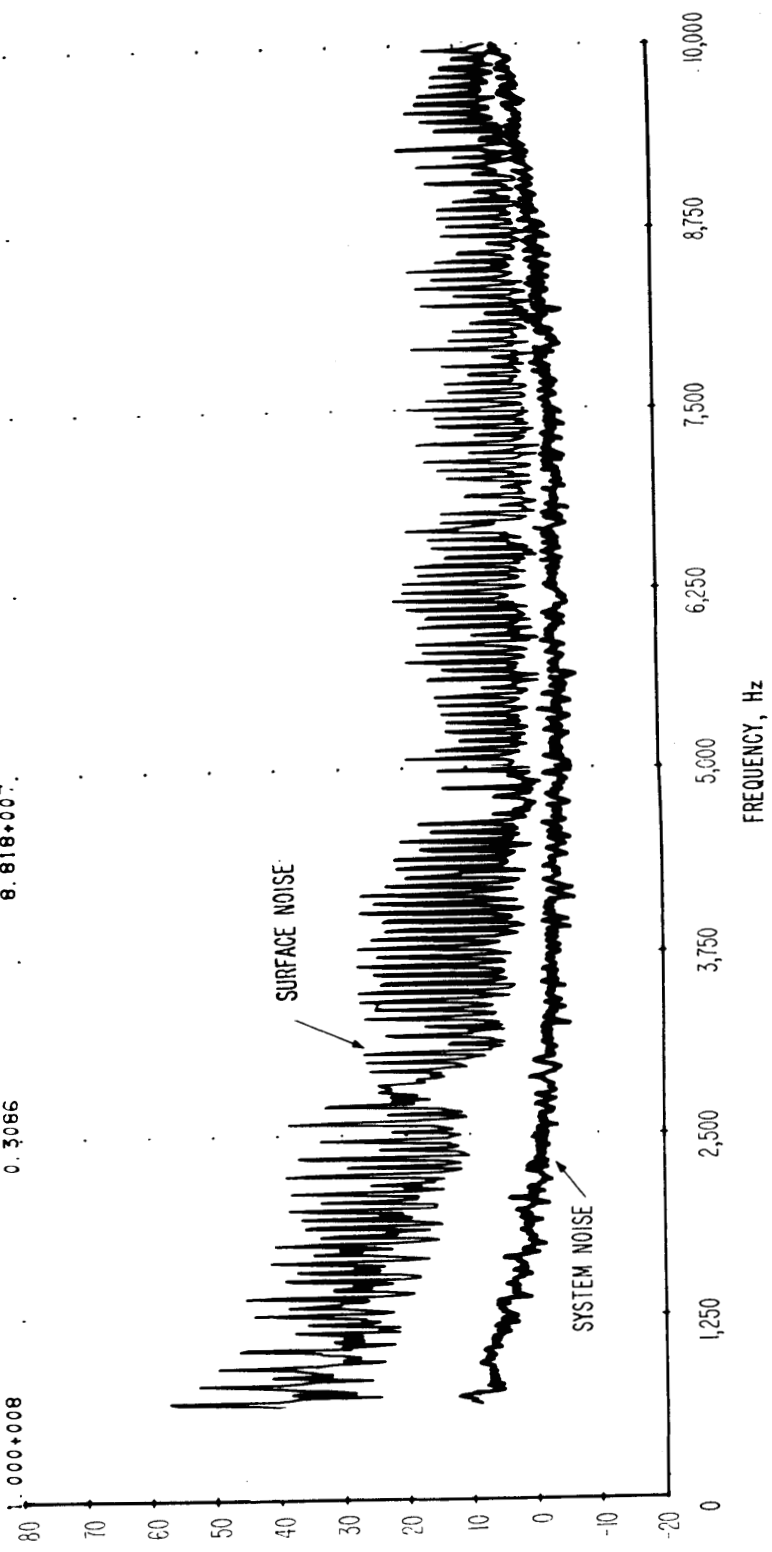

Figure 3-12 Spectrum of magnetic field strength obtained from a loop antenna, sensitive axis horizontal (North-South), frequency range 560 Hz to 10 kHz, located on Cedar Street in Wallace, Idaho, about 6:00 p.m., August 26, 1974. Neon lights are about 10 meters distant.

12 2 2248 20 1.584000 0.000000 07/20/74 16.45:25 35 42
 195.113 49.000 0.000000 0.000000 43.18 43.18
 32 87 8 26 73Gain corr. rec. F = -20 tot const. = 32.0
 C=24 RG= 1000 (-20dB) DG= 0 FG= 0 AG= 52
 1.000+006 0.3086 3.010+005

RMS MAGNETIC FIELD STRENGTH, H, DB RELATIVE TO ONE MICROAMPERE PER METER, FOR DISCRETE FREQUENCIES, OR
 RMS MAGNETIC-FIELD-STRENGTH SPECTRUM DENSITY LEVEL, H_p, DB RELATIVE TO
 ONE MICROAMPERE-PER-METER PER $\sqrt{9.77 \text{ Hz}}$, FOR BROAD BAND NOISE

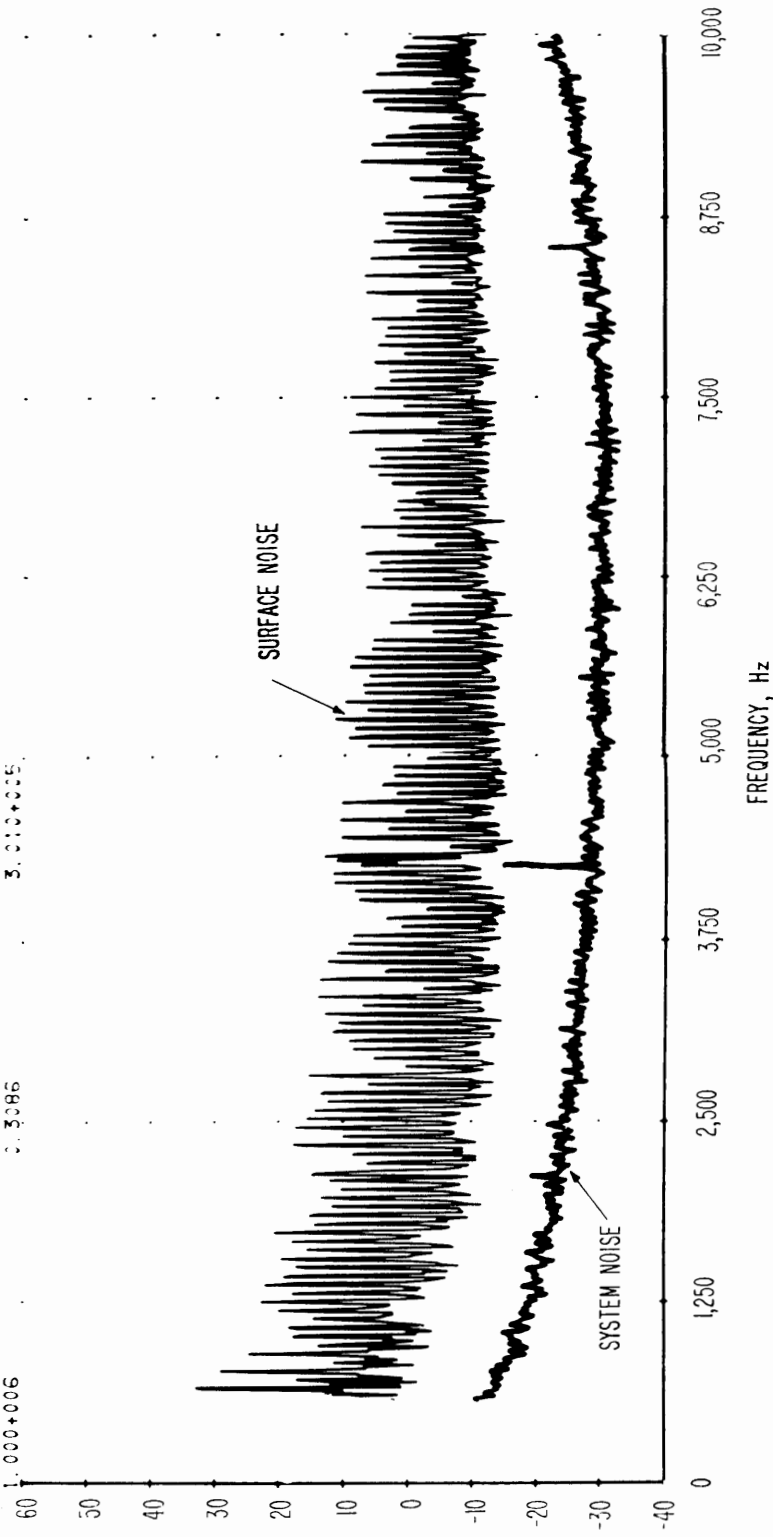

Figure 3-13 Spectrum of magnetic field strength obtained from a loop antenna, sensitive axis horizontal (East-West), frequency range 560 Hz to 10 kHz, located on Cedar Street in Wallace, Idaho, about 6:00 p.m., August 26, 1974. Neon lights are about 10 meters distant.

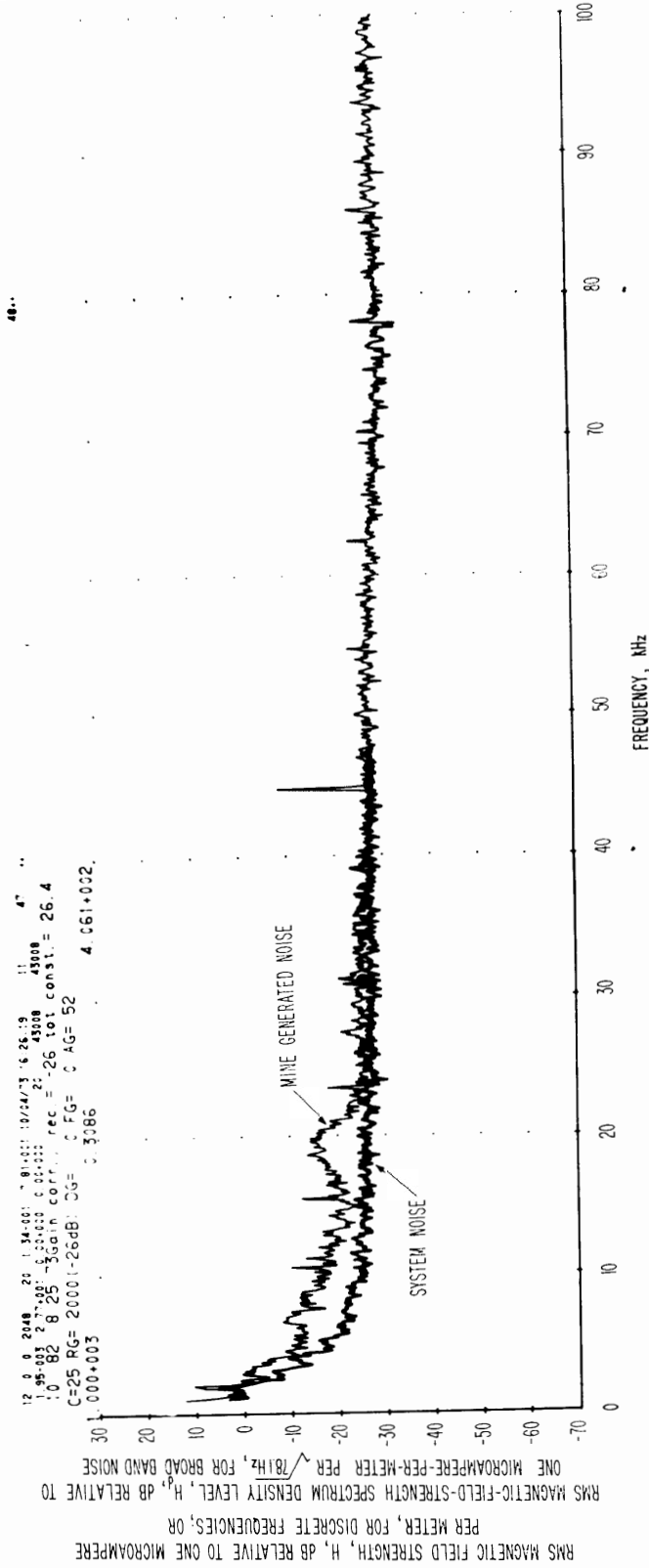

Figure 3-14 Spectrum of magnetic field strength obtained on a loop antenna 1 kHz to 100 kHz, Lucky Friday Mine, 1450 level, pump off, antenna sensitive axis horizontal (N-S), 2:05 p.m., August 25, 1973. Spectral resolution is 78.1 Hz.

12 0 0 2048 20 2.59+000 3.91+000 06/04/74 23:45:56 38 :82 **
 1.95-003 -3.82+001 0.00+000 0.00+000 20 43008 43008
 37 118 8 25 74Gain corr., rec.= -26 tot const.= 26.4
 C=42 RG= 2000 (-26dB) DG= 0 FG= 0 AG= 52
 0.000+007 0.3086 2.704+006.

RMS MAGNETIC FIELD STRENGTH, H, DB RELATIVE TO ONE MICROAMPERE PER METER, FOR DISCRETE FREQUENCIES; OR
 RMS MAGNETIC-FIELD-STRENGTH SPECTRUM DENSITY LEVEL, H, DB RELATIVE TO ONE MICROAMPERE-PER-METER PER $\sqrt{3.91}$ Hz, FOR BROAD BAND NOISE

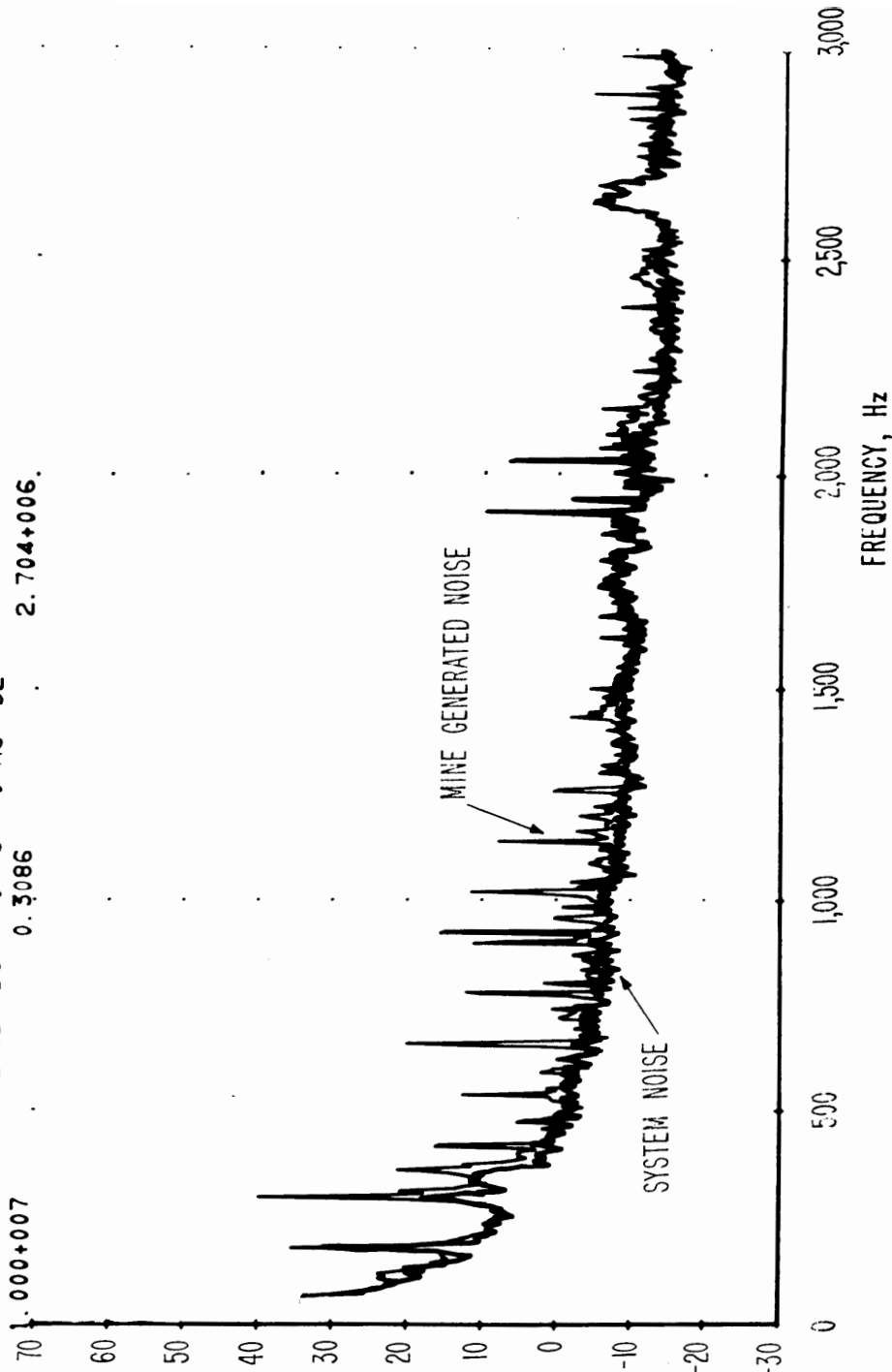

Figure 3-15 Spectrum of magnetic field strength obtained on a loop antenna 40 Hz to 3 kHz, Lucky Friday Mine, 1450 level, pump off, antenna sensitive axis horizontal (N-S), 2:05 p.m., August 25, 1973. Spectral resolution is 3.91 Hz.

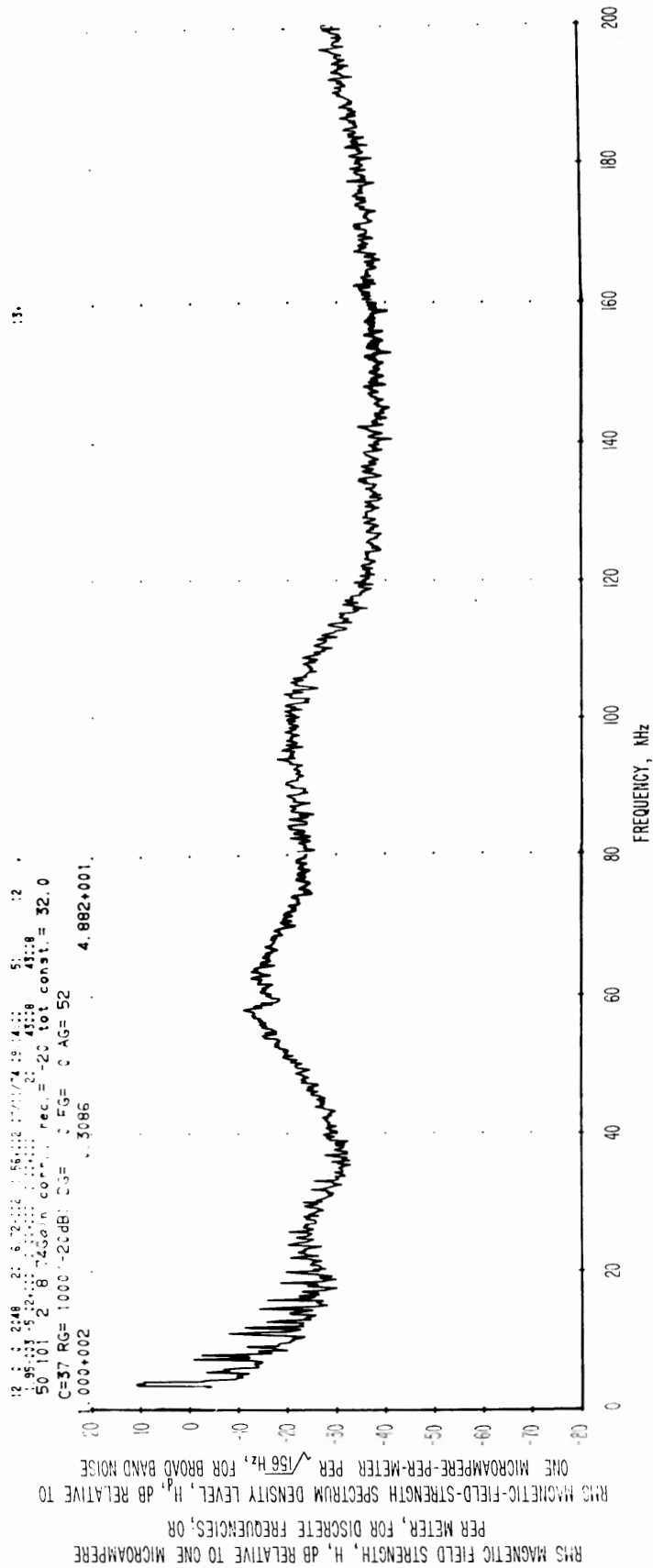

Figure 3-16 Spectrum of magnetic field strength obtained from a loop antenna, sensitive axis vertical. Calibration is valid over the frequency range from 3 kHz to 200 kHz. Location is at the 3650 level of Lucky Friday Mine. Time is about 10:00 a.m., February 8, 1974.

12 1 2248 21 5 75000 55000 74 18 1621 54 2
 1.95+03 5.85+01 1.10+01 1.10+01 21 4318 4318
 53 101 2 8 7.4gain corr. rec. F 0 tot const. = 52.0
 C=37 RG= 1001 CdBI CG= 0 FG= 0 AG= 52
 1.000+004 1.3085 4.731+003.

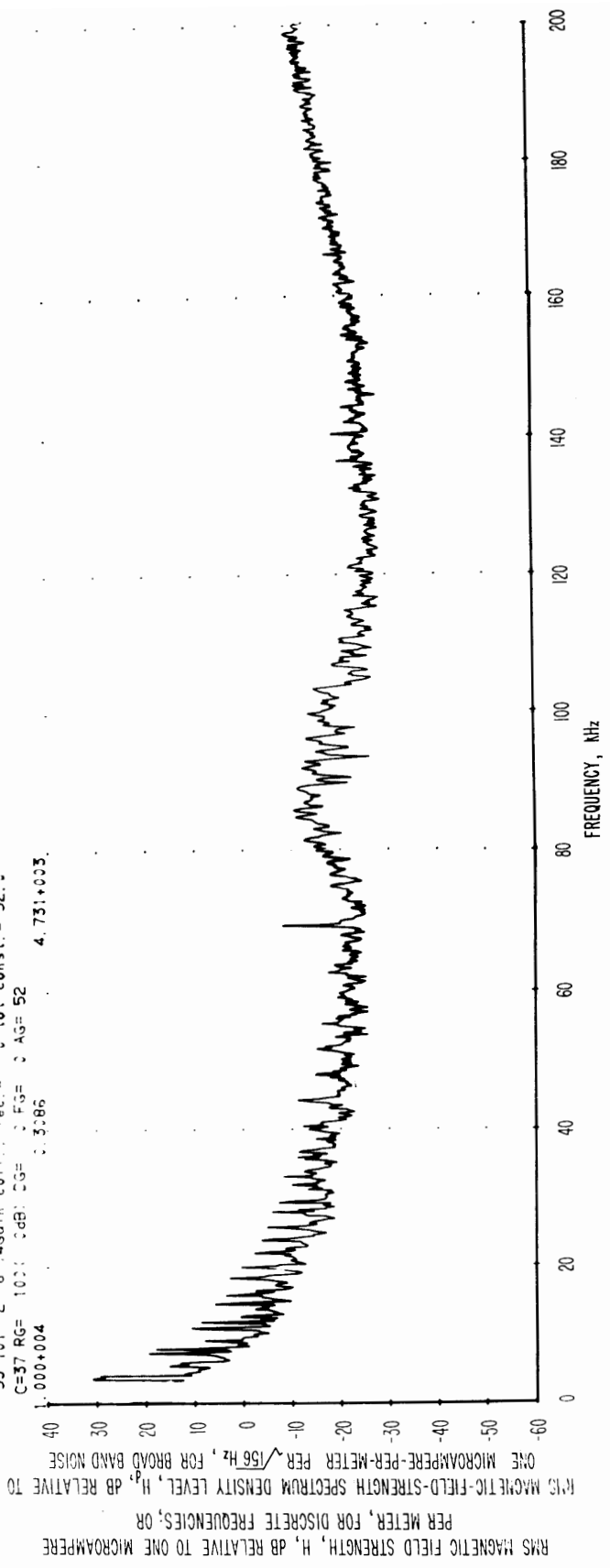

Figure 3-17 Spectrum of magnetic field strength obtained from a loop antenna, sensitive axis horizontal (North-South). Calibration is valid over the frequency range from 3 kHz to 200 kHz. Location is at the 3650 level of Lucky Friday Mine. Time is about 10:00 a.m., February 8, 1974.

12.1.5. 2:48 25 6.72:00 155:00 1974.12.25 49 2
 1.95:03 5.5:00 1.0:00 1.0:00 1.0:00 1.0:00 45:18
 48 101 2 8 74 gain const. = 20 tot const. = 32.0
 C=37 RG= 100:1:0.02 D3 0 50: 0 AS= 50
 1.000*002 4.698*001

RMS MAGNETIC FIELD STRENGTH, H, DB RELATIVE TO ONE MICROAMPERE
 PER METER, FOR DISCRETE FREQUENCIES, OR
 RMS MAGNETIC-FIELD-STRENGTH SPECTRUM DENSITY LEVEL, H, DB RELATIVE TO
 ONE MICROAMPERE-PER-METER PER $\sqrt{156}$ Hz, FOR BROAD BAND NOISE

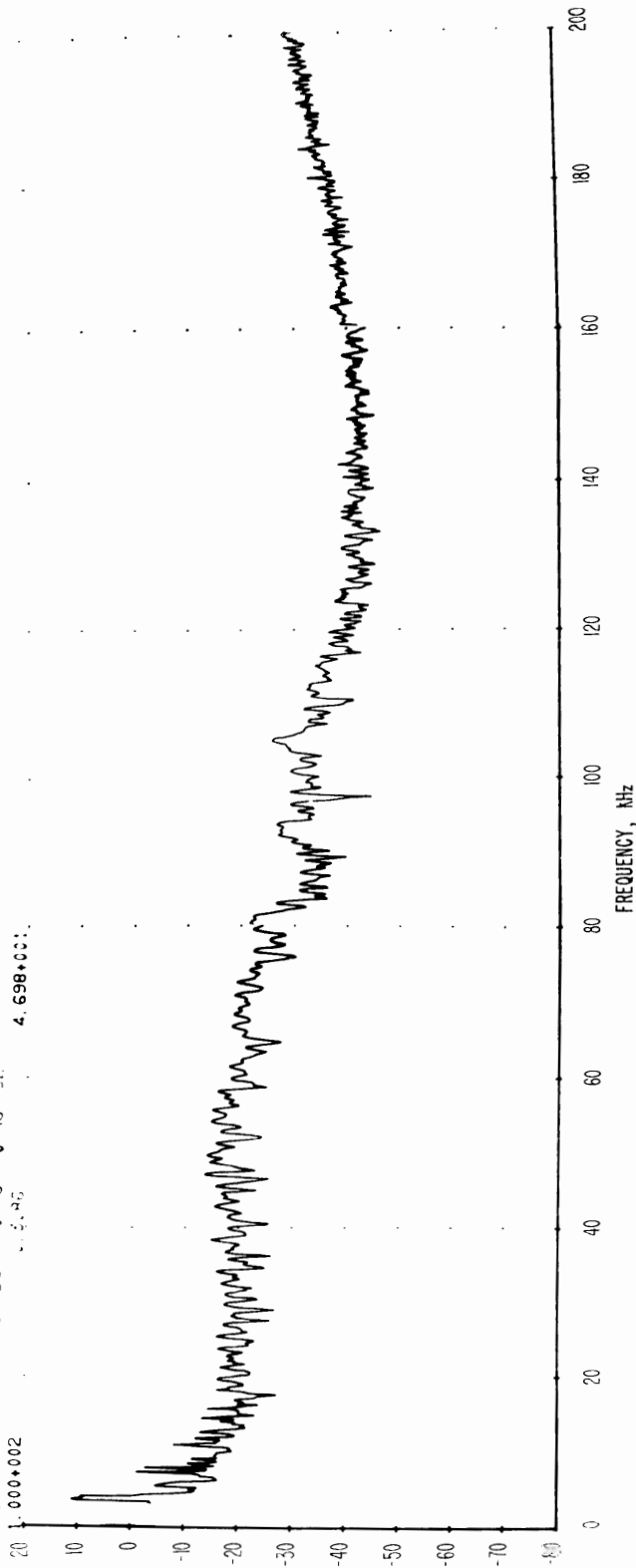

Figure 3-18 Spectrum of magnetic field strength obtained from a loop antenna, sensitive axis vertical. Calibration is valid over the frequency range from 3 kHz to 200 kHz. Location is at the 3650 level of Lucky Friday Mine. Time is about 10:00 a.m., February 8, 1974. Relatively quiet time.

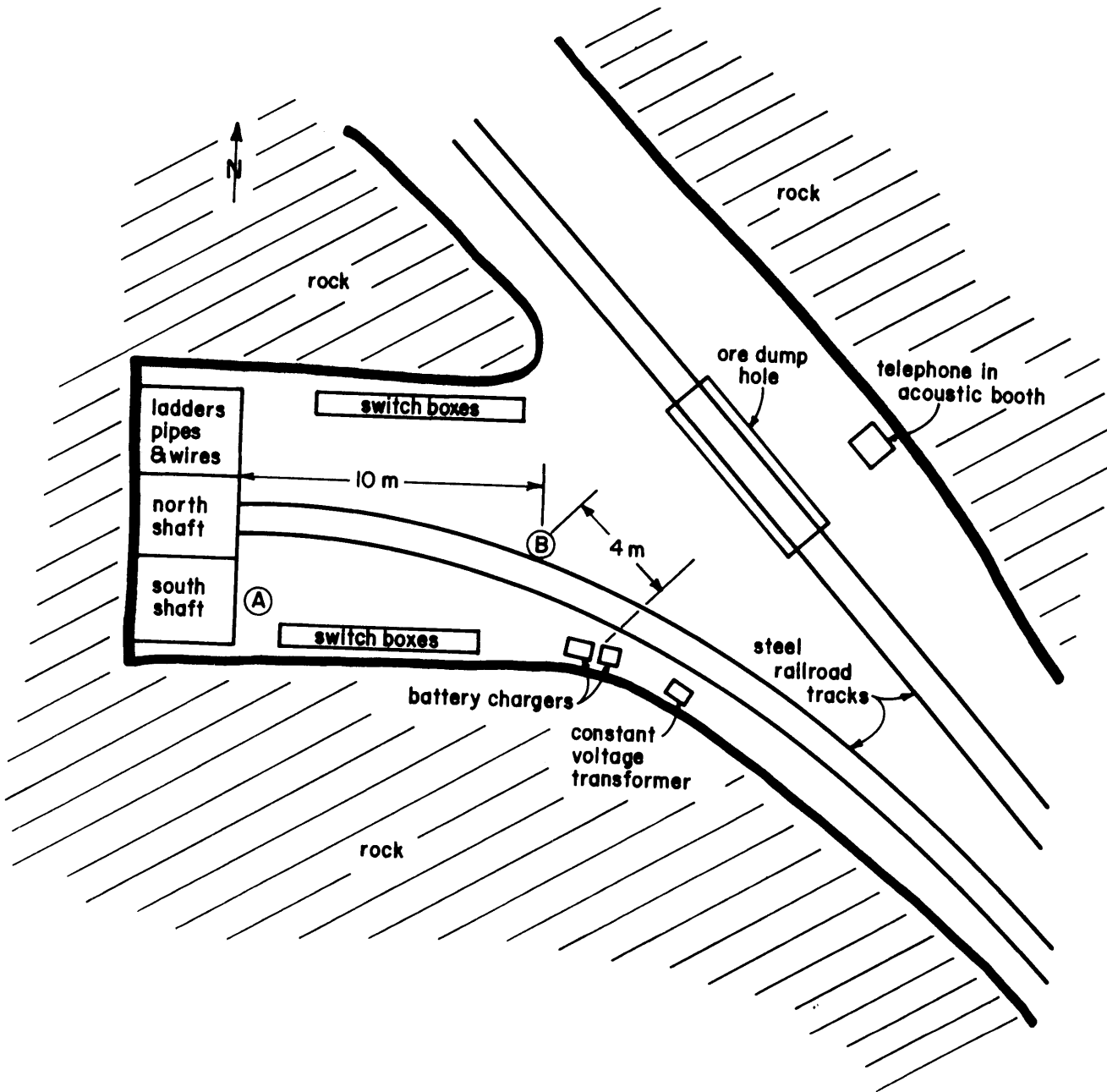

Figure 3-19 Plan view of portion of 4050 level, Lucky Friday Mine. Antennas were located at A and B.

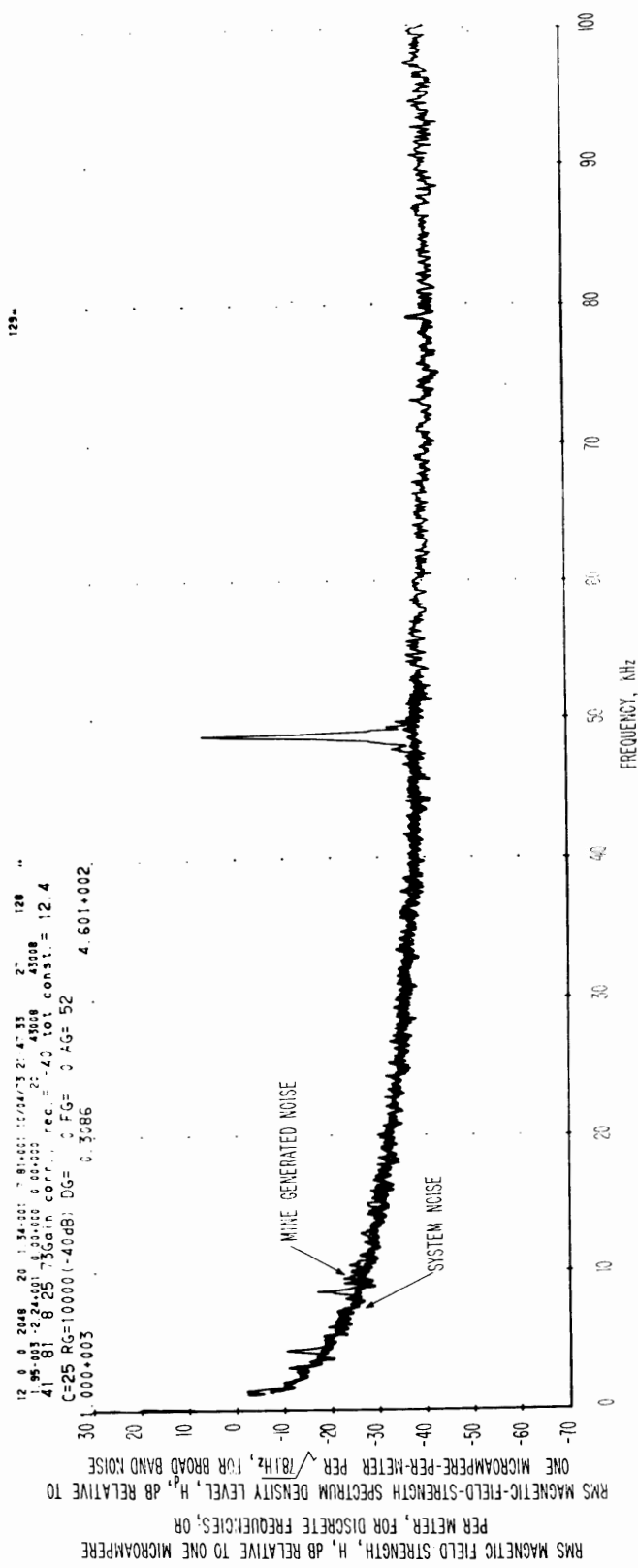

Figure 3-20 Spectrum of magnetic field strength obtained on a loop antenna 1 kHz to 100 kHz, Lucky Friday Mine, front of open south shaft doors, 4050 level, antenna sensitive axis horizontal (N-S), 11:09 a.m., August 25, 1973. Spectral resolution is 78.1 Hz. (Location A, Figure 3-19).

12 0 0 2048 20 2.69+000 3.91+000 06/04/74 23:34:59 24 112
 1.95-003 -3.60+001 0.00+000 0.00+000 20 43008 43008
 23 118 8 25 74Gain corr., rec. = -40 tot const. = 12.4
 C=42 RG=10000 (-40dB) DG= 0 FG= 0 AG= 52
 1.000+006 0.3086 3.567+005

RMS MAGNETIC FIELD STRENGTH, H, DB RELATIVE TO ONE MICROAMPERE
 PER METER, FOR DISCRETE FREQUENCIES; OR
 RMS MAGNETIC-FIELD-STRENGTH SPECTRUM DENSITY LEVEL, H_p, DB RELATIVE TO
 ONE MICROAMPERE-PER-METER PER $\sqrt{391}$ Hz, FOR BROAD BAND NOISE

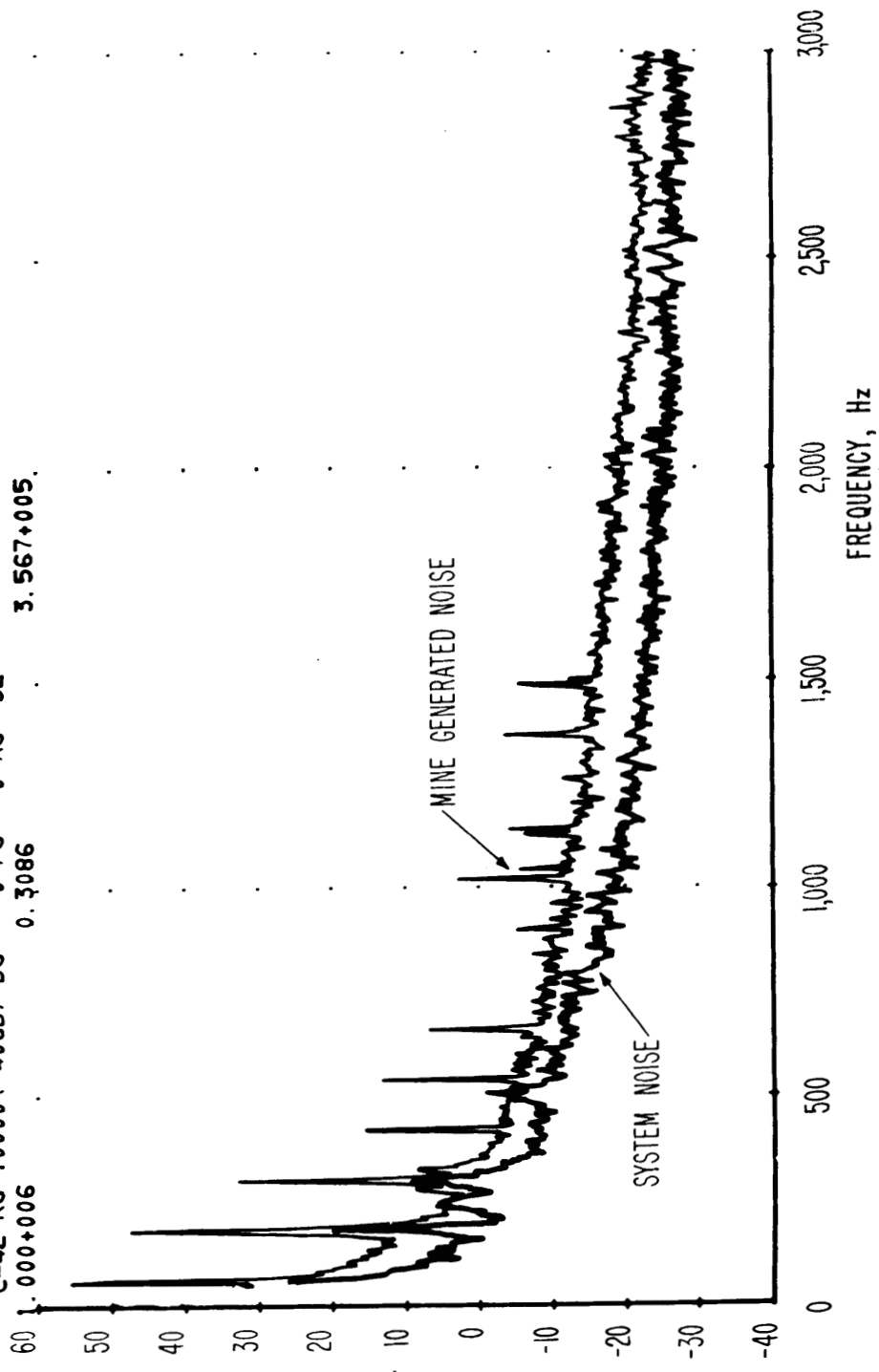

Figure 3-21 Spectrum of magnetic field strength obtained on a loop antenna 40 Hz to 3 kHz, Lucky Friday Mine, front of open south shaft doors, 4050 level, antenna sensitive axis horizontal (N-S), 11:09 a.m., August 25, 1973. Spectral resolution is 3.91 Hz. (Location A, Figure 3-19).

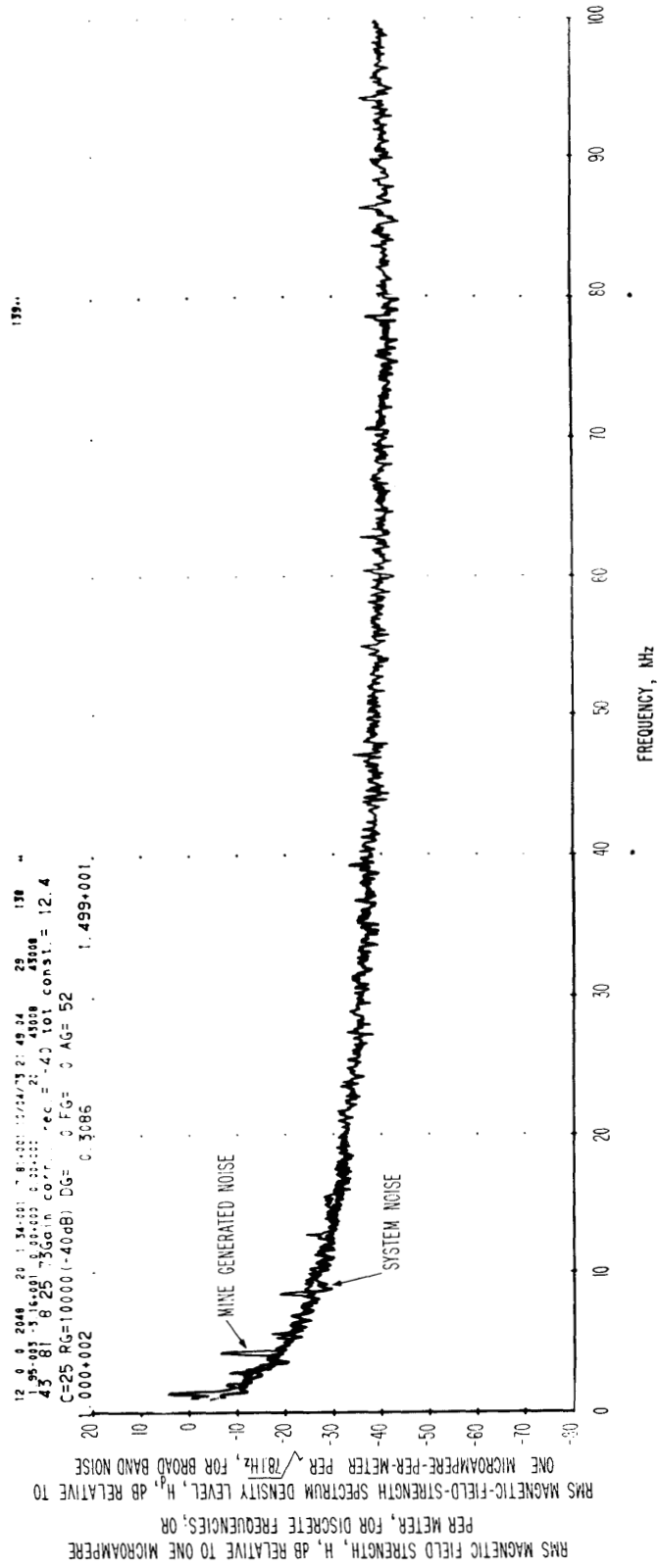

Figure 3-22 Spectrum of magnetic field strength obtained on a loop antenna 1 kHz to 100 kHz, Lucky Friday Mine, front of open south shaft doors, 4050 level, water pump off, antenna sensitive axis vertical, 11:25 a.m., August 25, 1973. Spectral resolution is 78.1 Hz.

12 0 0 2048 20 2.69+000 3.91+000 06/04/74 23:36:33 25 122 *
 1.95-003 -4.11+001 0.00+000 0.00+000 20 43008 43008
 25 118 8 25 74Gain corr., rec. = -40 tot const. = 12.4
 C=42 RG=10000 (-40dB) DG= 0 FG= 0 AG= 52
 0.000+006 0.3086 1.220+005.

RMS MAGNETIC FIELD STRENGTH, H_p , DB RELATIVE TO ONE MICROAMPERE
 PER METER, FOR DISCRETE FREQUENCIES; OR
 RMS MAGNETIC-FIELD-STRENGTH SPECTRUM DENSITY LEVEL, H_p , DB RELATIVE TO
 ONE MICROAMPERE-PER-METER PER $\sqrt{3.91}$ Hz, FOR BROAD BAND NOISE

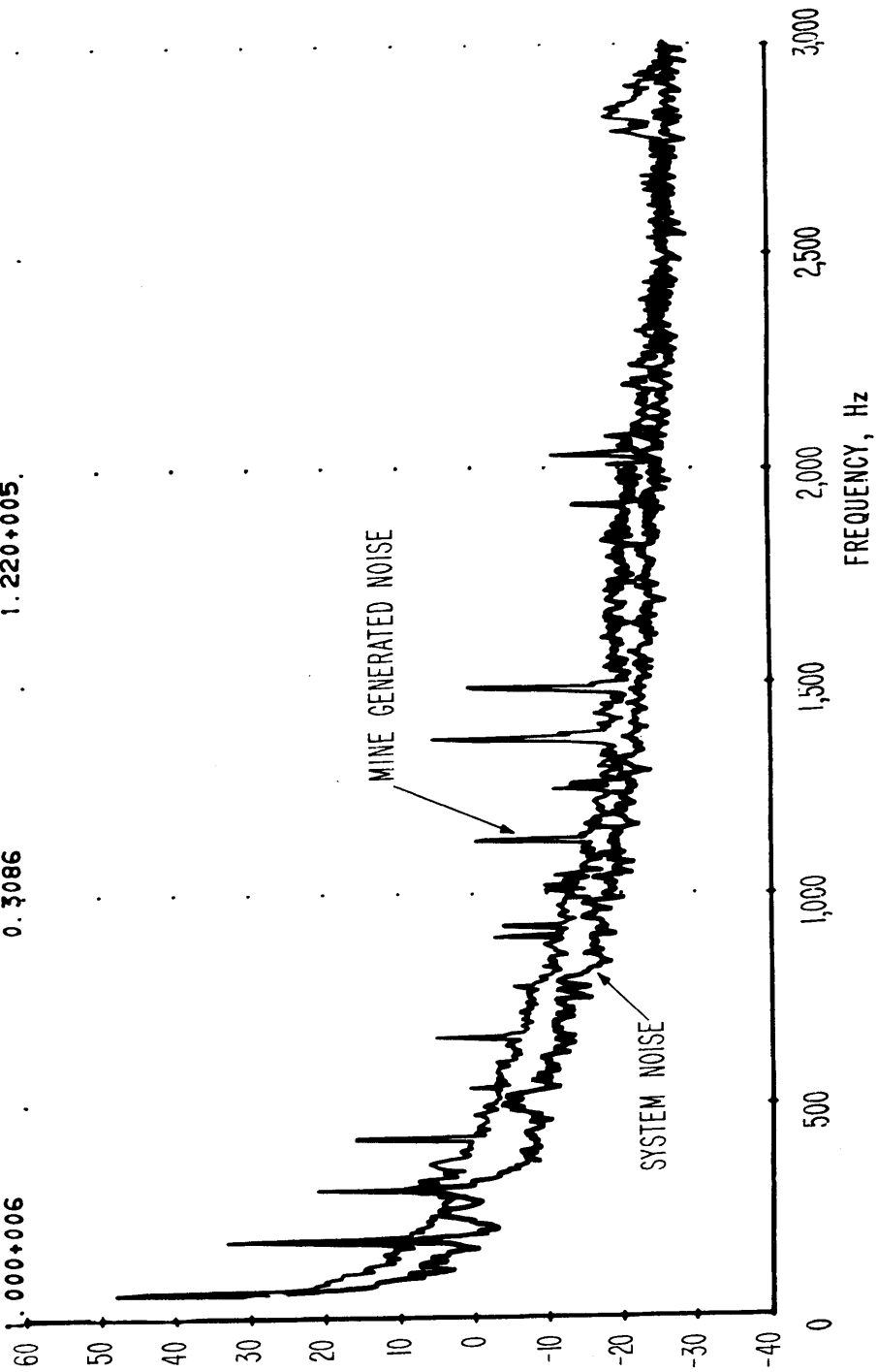

Figure 3-23 Spectrum of magnetic field strength obtained on a loop antenna 40 Hz to 3 kHz, Lucky Friday Mine, front of open south shaft doors, 4050 level, water pump off, antenna sensitive axis vertical, 11:25 a.m., August 25, 1973. Spectral resolution is 3.91 Hz.

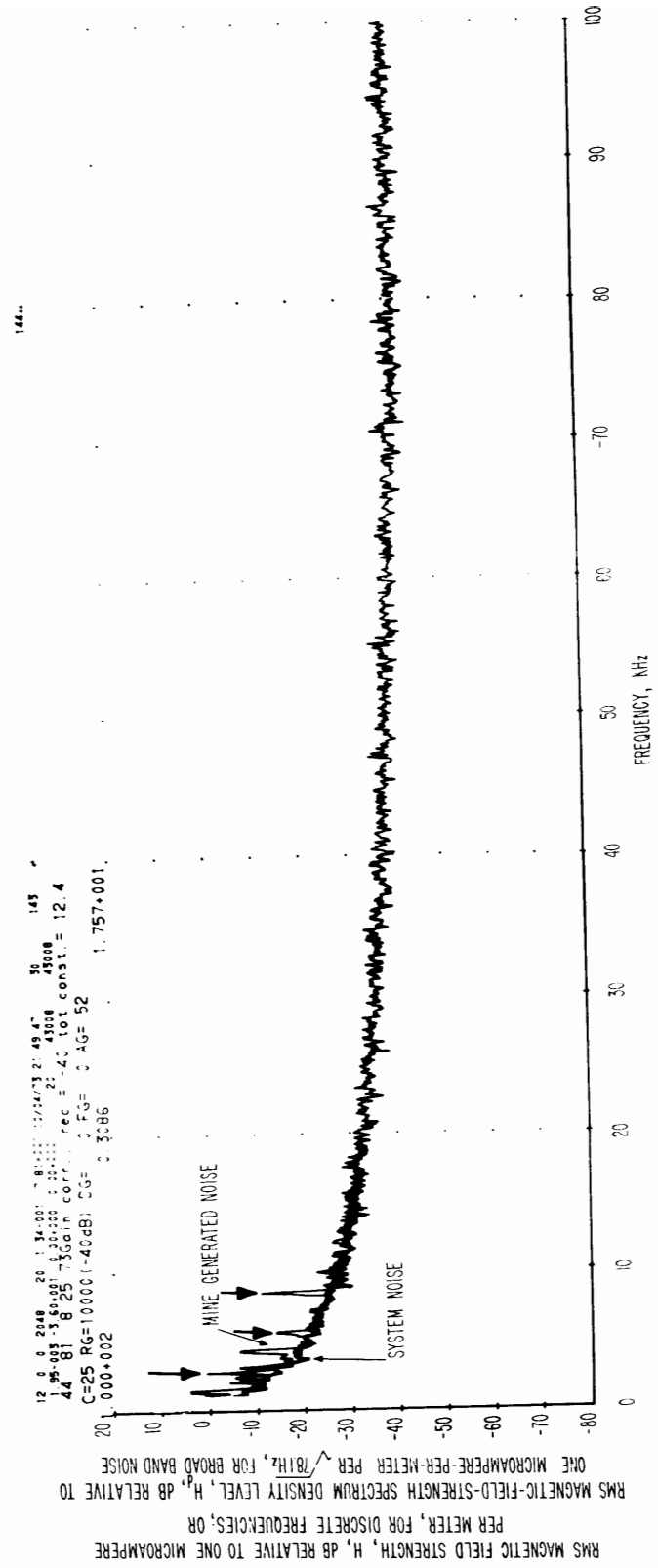

Figure 3-24 Spectrum of magnetic field strength obtained on a loop antenna 1 kHz to 100 kHz, Lucky Friday Mine, front of open south shaft doors, 4050 level, 440 volt--70 ampere water pump operating, antenna sensitive axis vertical, 11:28 a.m., August 25, 1973. Spectral resolution is 78.1 Hz.

12 0 0 2048 20 2.69+000 3.91+000 56/4474 23:37:20 27 127 *
 1.95-003 -4.58+001 0.00+000 0.00+000 20 43008 43008
 26 118 8 25 74Gain corr., rec. = -40 tot const. = 12.4
 C=42 RG=10000 (-40dB) DG= 0 FG= 0 AG= 52
 1.000+006 0.3086 1.558+005.

RMS MAGNETIC FIELD STRENGTH, H, dB RELATIVE TO ONE MICROAMPERE
 PER METER, FOR DISCRETE FREQUENCIES; OR
 RMS MAGNETIC-FIELD-STRENGTH SPECTRUM DENSITY LEVEL, H, dB RELATIVE TO
 ONE MICROAMPERE-PER-METER PER $\sqrt{391}$ Hz, FOR BROAD BAND NOISE

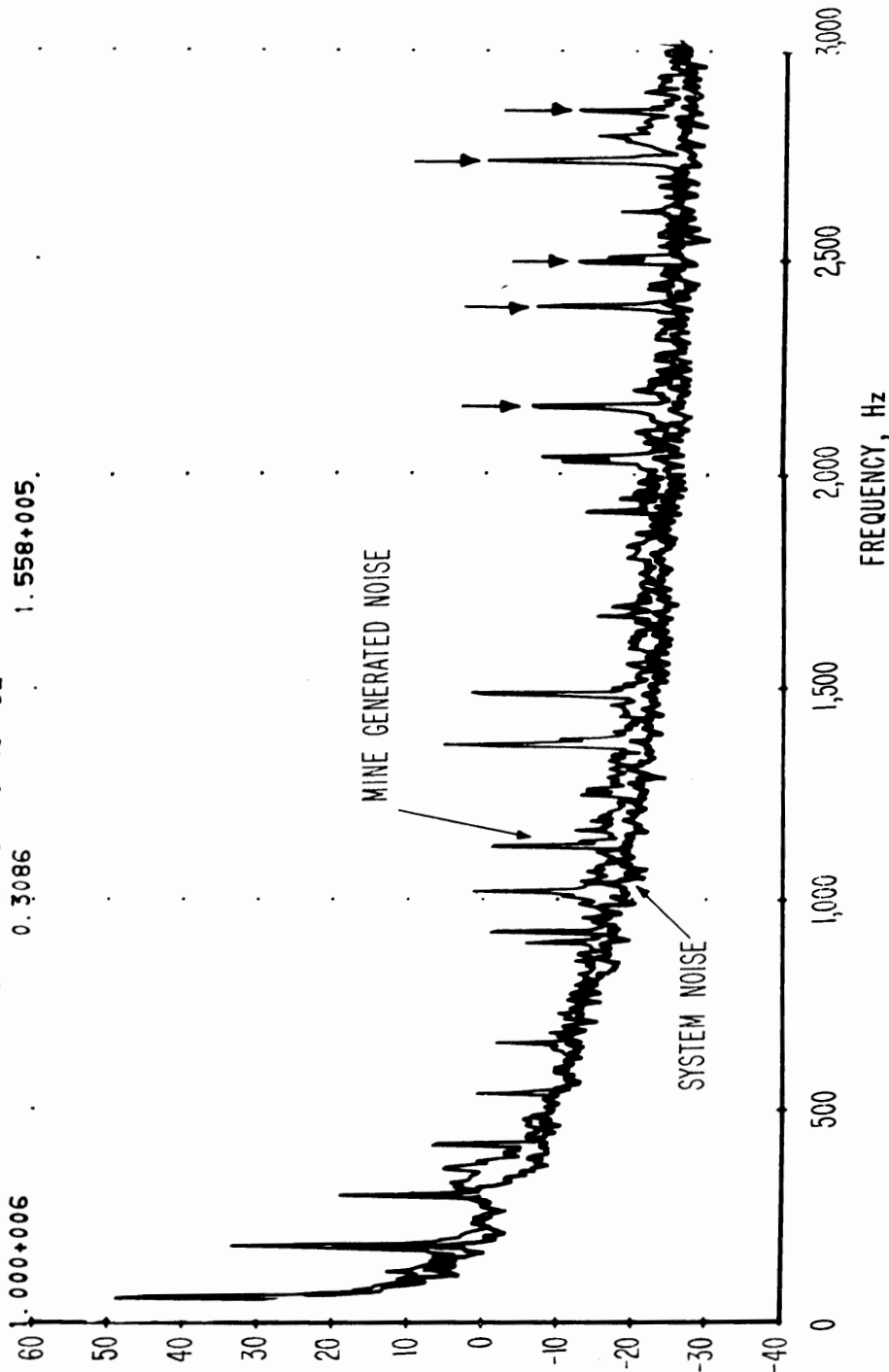

Figure 3-25 Spectrum of magnetic field strength obtained on a loop antenna 40 Hz to 3 kHz, Lucky Friday Mine, front of open south shaft doors, 4050 level, 440 volt, 70 ampere water pump operating, antenna sensitive axis vertical, 11:28 a.m., August 25, 1973. Spectral resolution is 3.91 Hz.

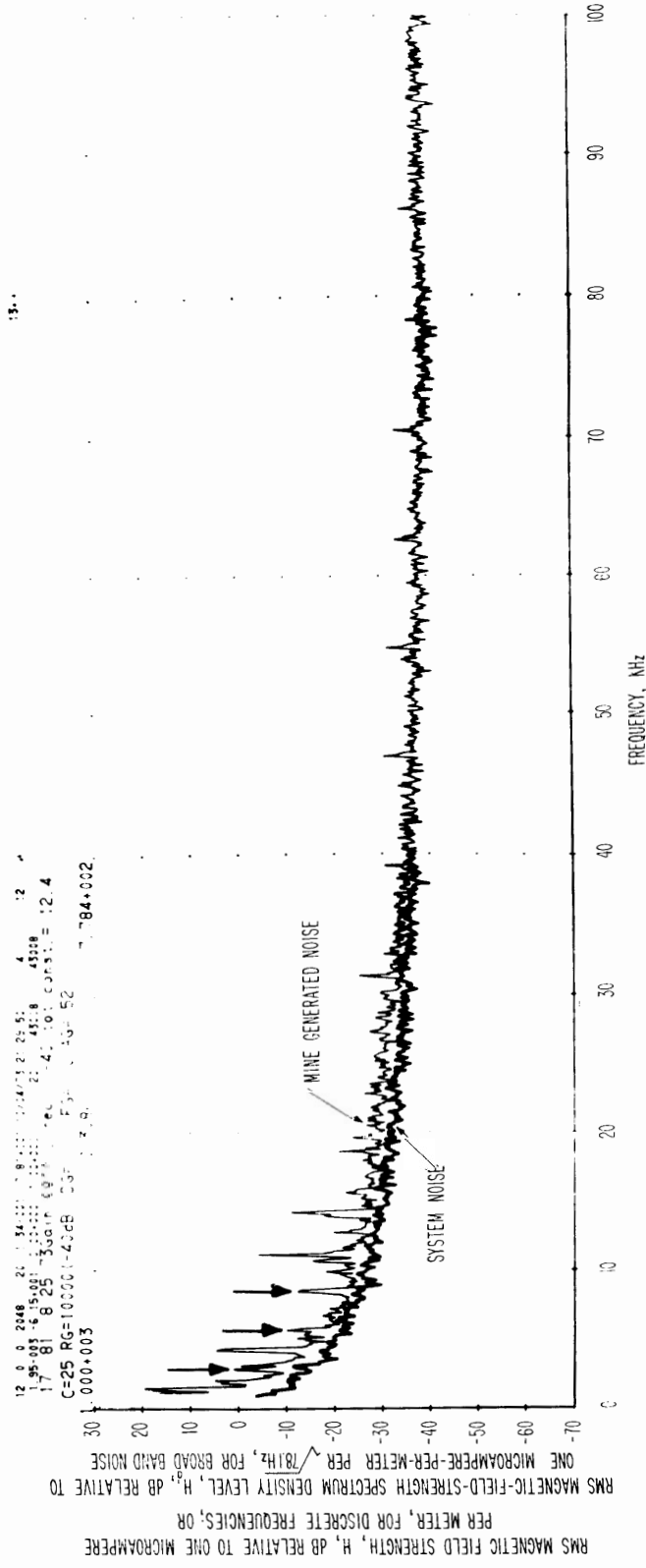

Figure 3-26 Spectrum of magnetic field strength obtained on a loop antenna 1 kHz to 100 kHz, Lucky Friday Mine, 4050 level, 10 meters from shaft, water pump operating, antenna sensitive axis vertical, 8:17 a.m., August 25, 1973. Spectral resolution is 78.1 Hz. (Location B, Figure 3-19).

12 0 0 2048 20 2.69+000 3.91+000 06/04/74 23:19:17 4 12 *
 1.95-003 -6.39+001 0.00+000 0.00+000 20 43008 43008
 3 118 8 25 73Gain corr., rec. = -40 tot const. = 12.4
 C=42 RG=10000 (-40dB) DG= 0 FG= 0 AG= 52
 1.000+007 0.3086 4.339+006.

RMS MAGNETIC FIELD STRENGTH, H, DB RELATIVE TO ONE MICROAMPERE
 PER METER, FOR DISCRETE FREQUENCIES; OR
 RMS MAGNETIC-FIELD-STRENGTH SPECTRUM DENSITY LEVEL, H, DB RELATIVE TO
 ONE MICROAMPERE-PER-METER PER $\sqrt{391 \text{ Hz}}$, FOR BROAD BAND NOISE

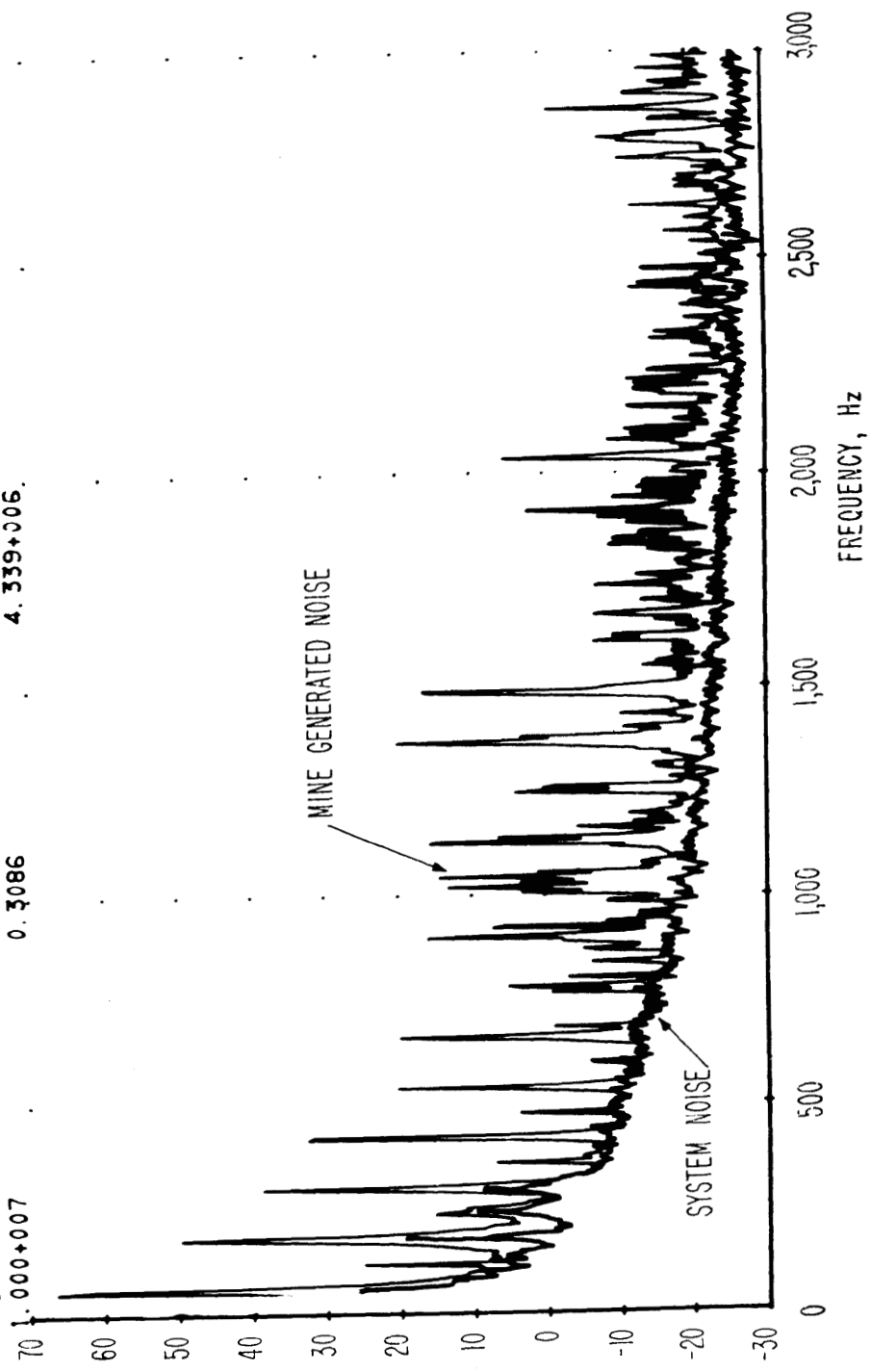

Figure 3-27 Spectrum of magnetic field strength obtained on a loop antenna 40 Hz to 3 kHz, Lucky Friday Mine, 4050 level, 10 meters from shaft, water pump operating, antenna sensitive axis vertical, 8:17 a.m., August 25, 1973. Spectral resolution is 3.91 Hz. (Location B, Figure 3-19).

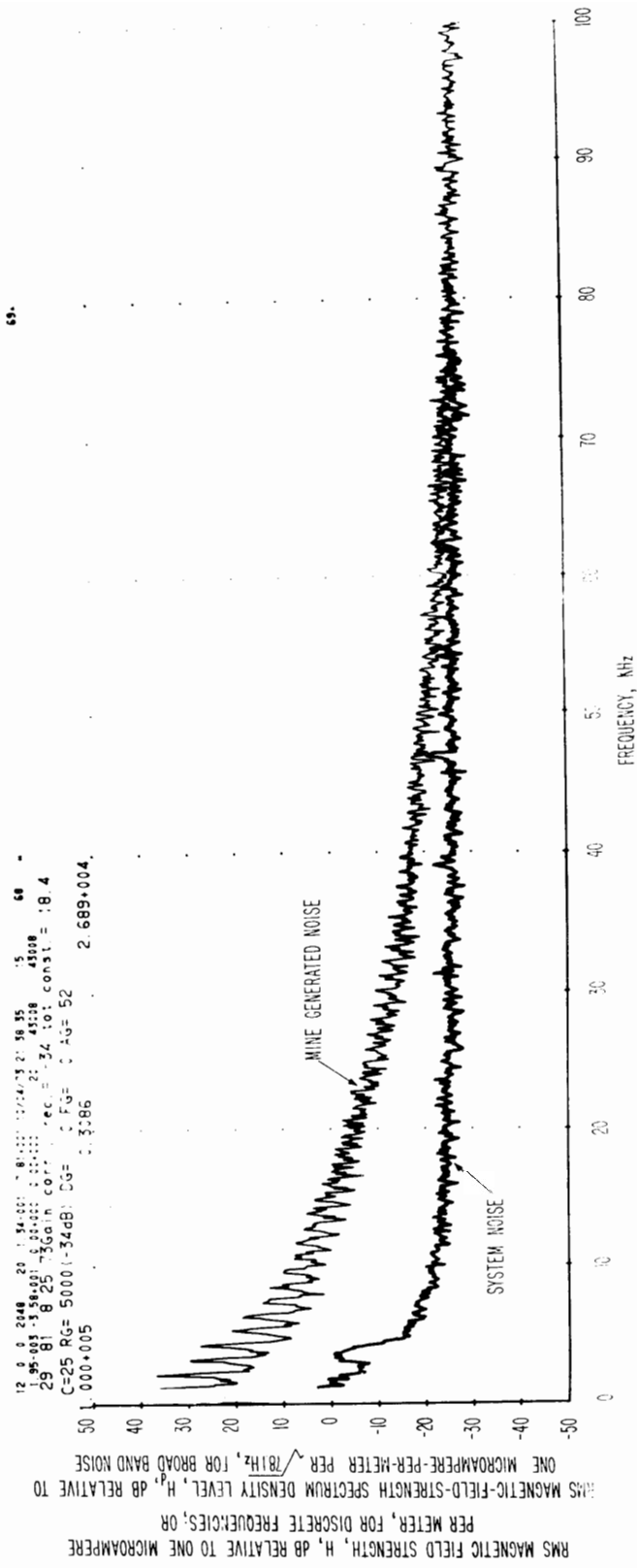

Figure 3-28 Spectrum of magnetic field strength obtained on a loop antenna 1 kHz to 100 kHz, Lucky Friday Mine, 4050 level, 10 meters from shaft, battery charger operating, antenna sensitive axis horizontal (N-S), 9:40 a.m., August 25, 1973. Spectral resolution is 78.1 Hz.

12 0 0 2048 20 2.69+000 3.91+000 06/04/74 23:27:53 15 67
 1.95-003 -3.98+001 0.00+000 0.00+000 43008 43008
 14 118 8 25 73Gain corr., rec. = -34 tot const. = 18.4
 C=42 RG= 5000 (-34dB) DG= 0 FG= 0 AG= 52
 0.000+006 0.3086 5.469+005

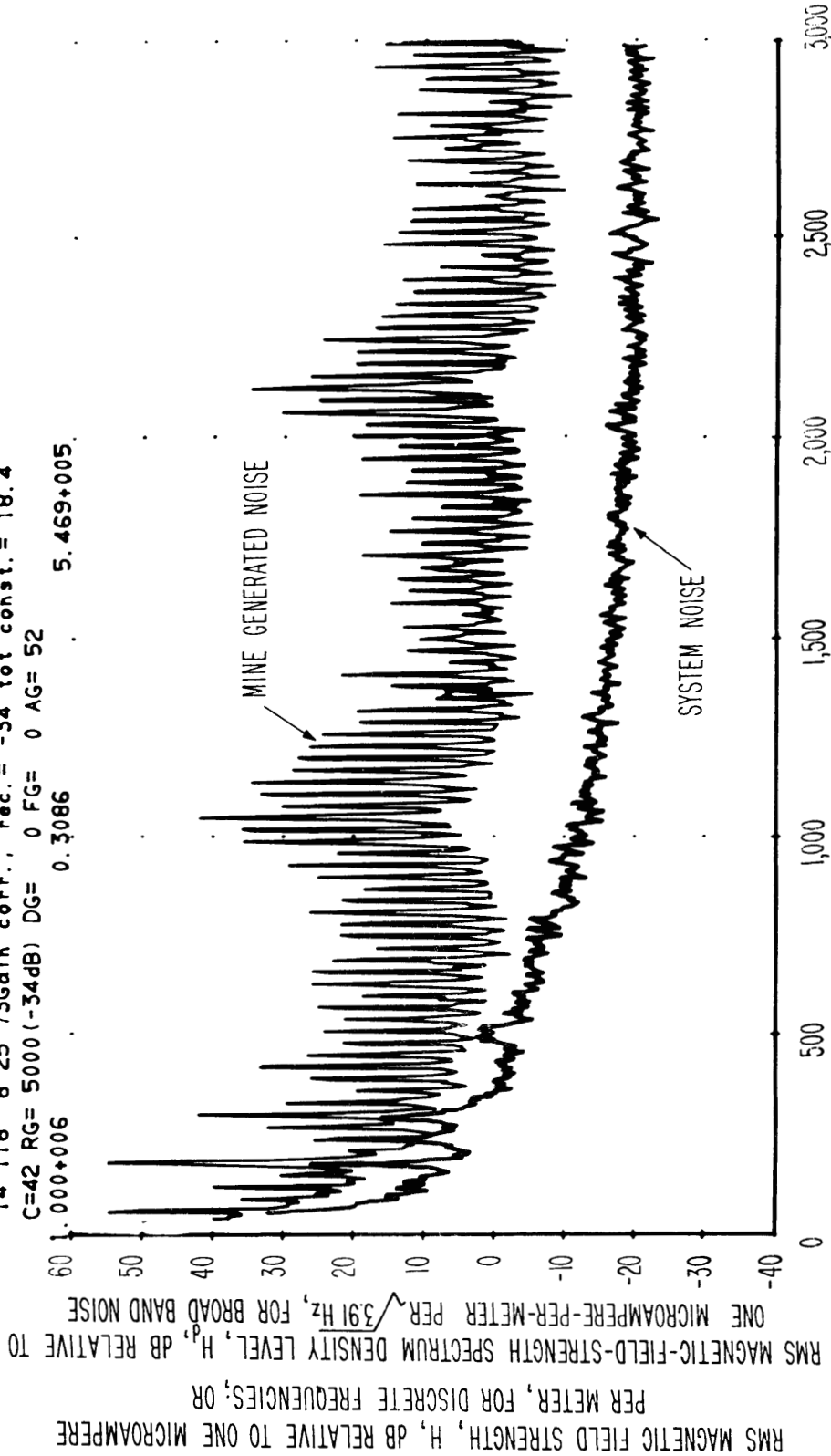

Figure 3-29 Spectrum of magnetic field strength obtained on a loop antenna 40 Hz to 3 kHz, Lucky Friday Mine, 4050 level, 10 meters from shaft, battery charger operating, antenna sensitive axis horizontal (N-S), 9:40 a.m., August 25, 1973. Spectral resolution is 3.91 Hz.

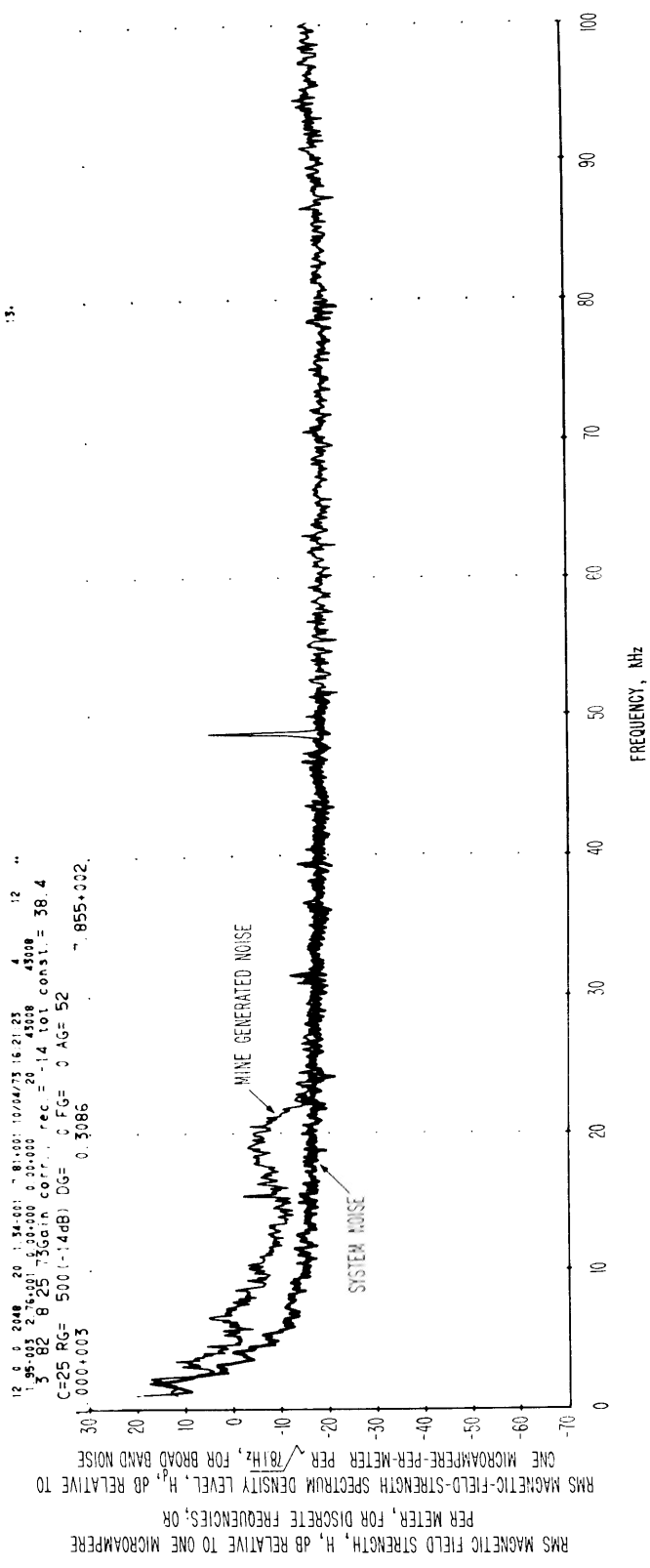

Figure 3-30 Spectrum of magnetic field strength obtained on a loop antenna 1 kHz to 100 kHz, Lucky Friday Mine, 4050 level, loop antenna around driver of locomotive while locomotive is pulling an ore car, antenna sensitive axis vertical, 11:59 a.m., August 25, 1973. Spectral resolution is 78.1 Hz.

12 0 0 2048 20 2.69+000 3.91+000 06/24/74 23:40:28 3: 1.47
 1.95-003 -4.06+001 0.00+000 0.00+000 20 43:08 43:08
 30 118 8 25 74Gain corr., rec. = -14 tot const. = 38.4
 C=42 RG= 500 (-14dB) DG= 0 FG= 0 AG= 52
 .000+009 0.3086 5.241+008.

RMS MAGNETIC FIELD STRENGTH, H, DB RELATIVE TO ONE MICROAMPERE PER METER, FOR DISCRETE FREQUENCIES; OR
 RMS MAGNETIC-FIELD-STRENGTH SPECTRUM DENSITY LEVEL, H_p, DB RELATIVE TO ONE MICROAMPERE-PER-METER PER $\sqrt{3.91}$ Hz, FOR BROAD BAND NOISE

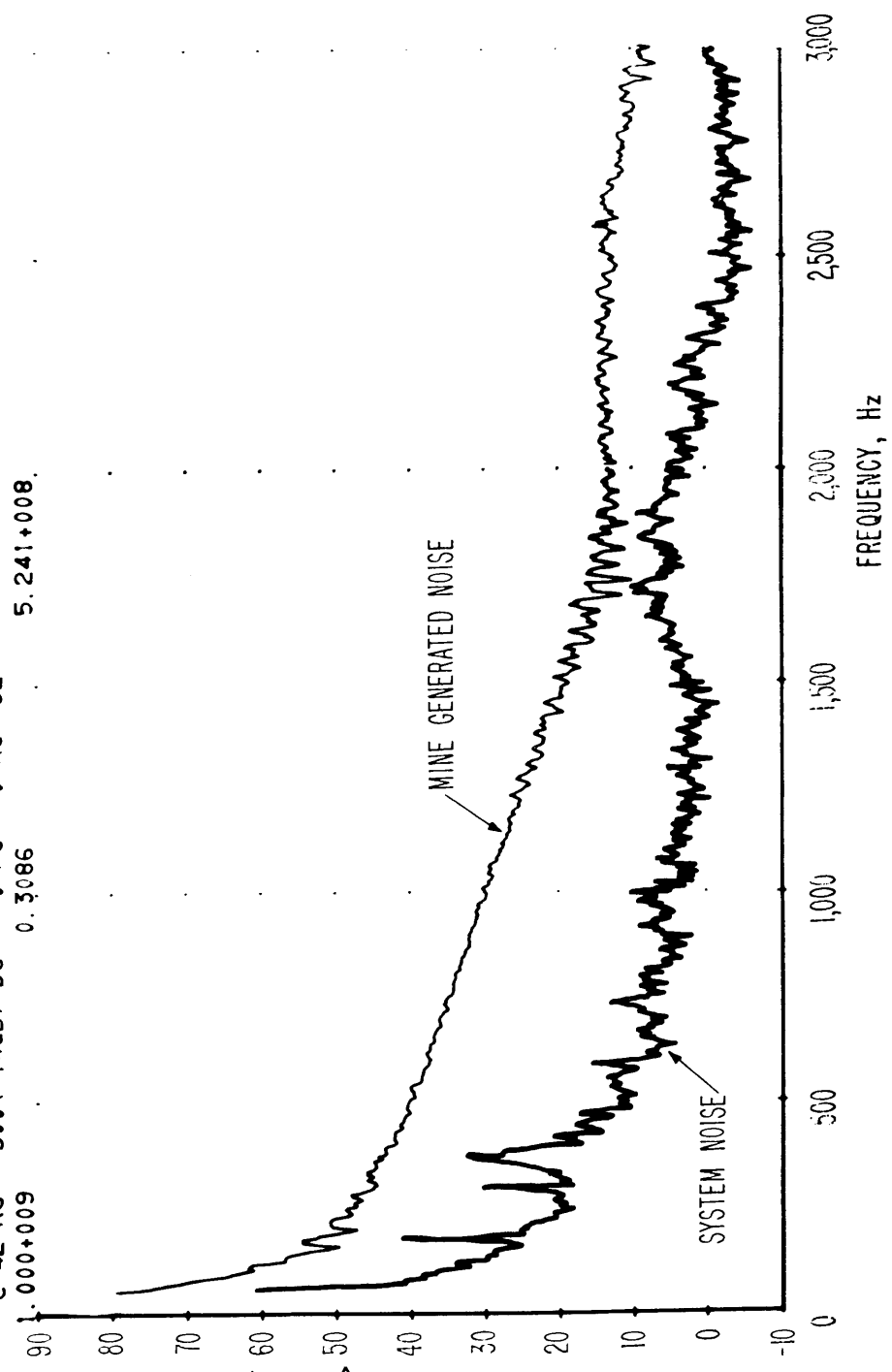

Figure 3-31

Spectrum of magnetic field strength obtained on a loop antenna 40 Hz to 3 kHz, Lucky Friday Mine, 4050 level, loop antenna around driver of locomotive while locomotive is pulling an ore car, antenna sensitive axis vertical, 11:59 a.m., August 25, 1973. Spectral resolution is 3.91 Hz.

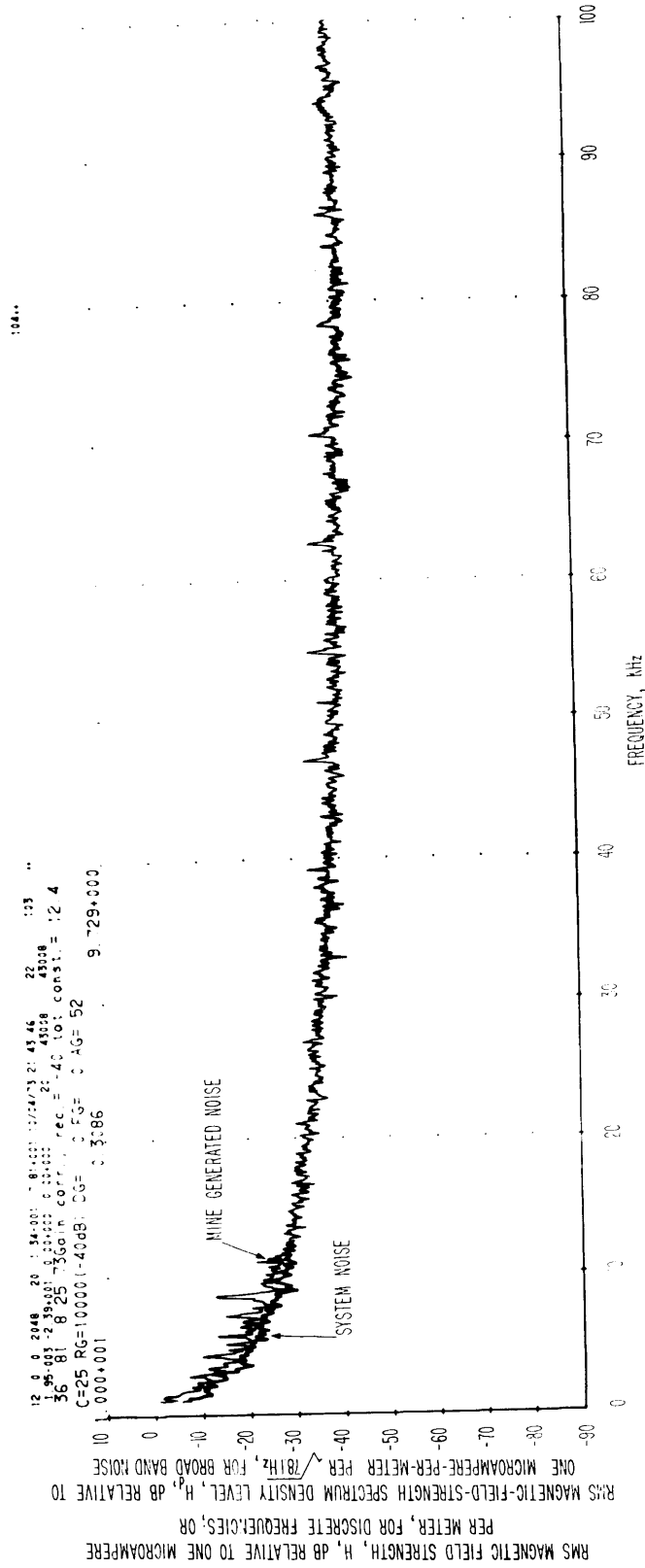

Figure 3-32 Spectrum of magnetic field strength obtained on a loop antenna 1 kHz to 100 kHz, Lucky Friday Mine, 4050 level, near face area, antenna sensitive axis horizontal perpendicular to rails, 10:36 a.m., August 25, 1973. Spectral resolution is 78.1 Hz.

12 0 0 2048 20 2.69+000 3.91+000 06/04/74 23:31:51 20 92 *
 1.95-003 -3.30+001 0.00+000 0.00+000 20 43008 43008
 19 118 8 25 74Gain corr., rec. = -40 tot const. = 12.4
 C=42 RG=10000 (-40dB) DG= 0 FG= 0 AG= 52
 0.3086 8.143+004.

RMS MAGNETIC FIELD STRENGTH, H, dB RELATIVE TO ONE MICROAMPERE
 PER METER, FOR DISCRETE FREQUENCIES; OR
 RMS MAGNETIC-FIELD-STRENGTH SPECTRUM DENSITY LEVEL, H_p, dB RELATIVE TO
 ONE MICROAMPERE-PER-METER PER $\sqrt{3.91}$ Hz, FOR BROAD BAND NOISE

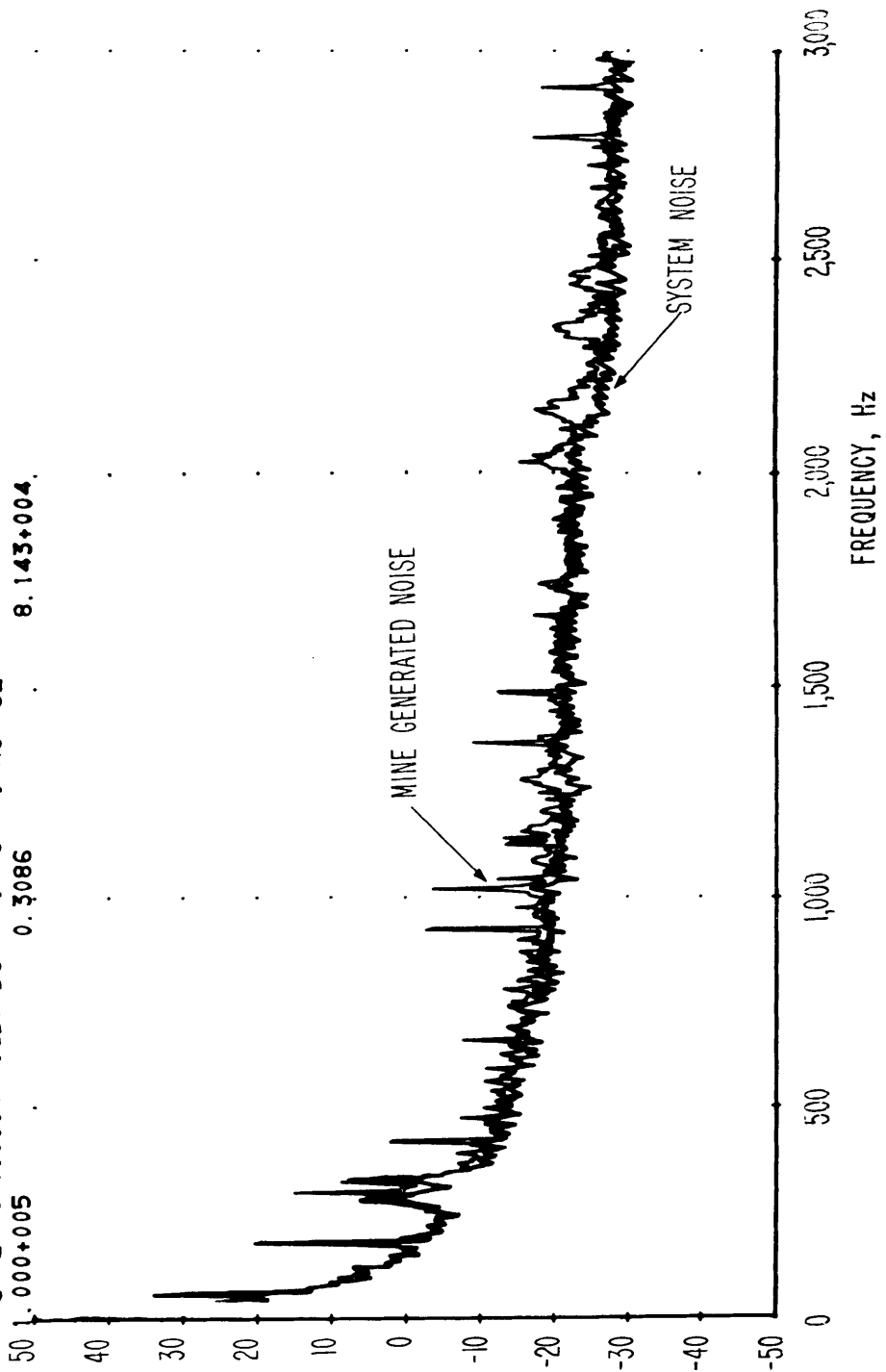

Figure 3-33 Spectrum of magnetic field strength obtained on a loop antenna 40 Hz to 3 kHz, Lucky Friday Mine, 4050 level, near face area, antenna sensitive axis vertical, 10:38 a.m., August 25, 1973. Spectral resolution is 3.91 Hz.

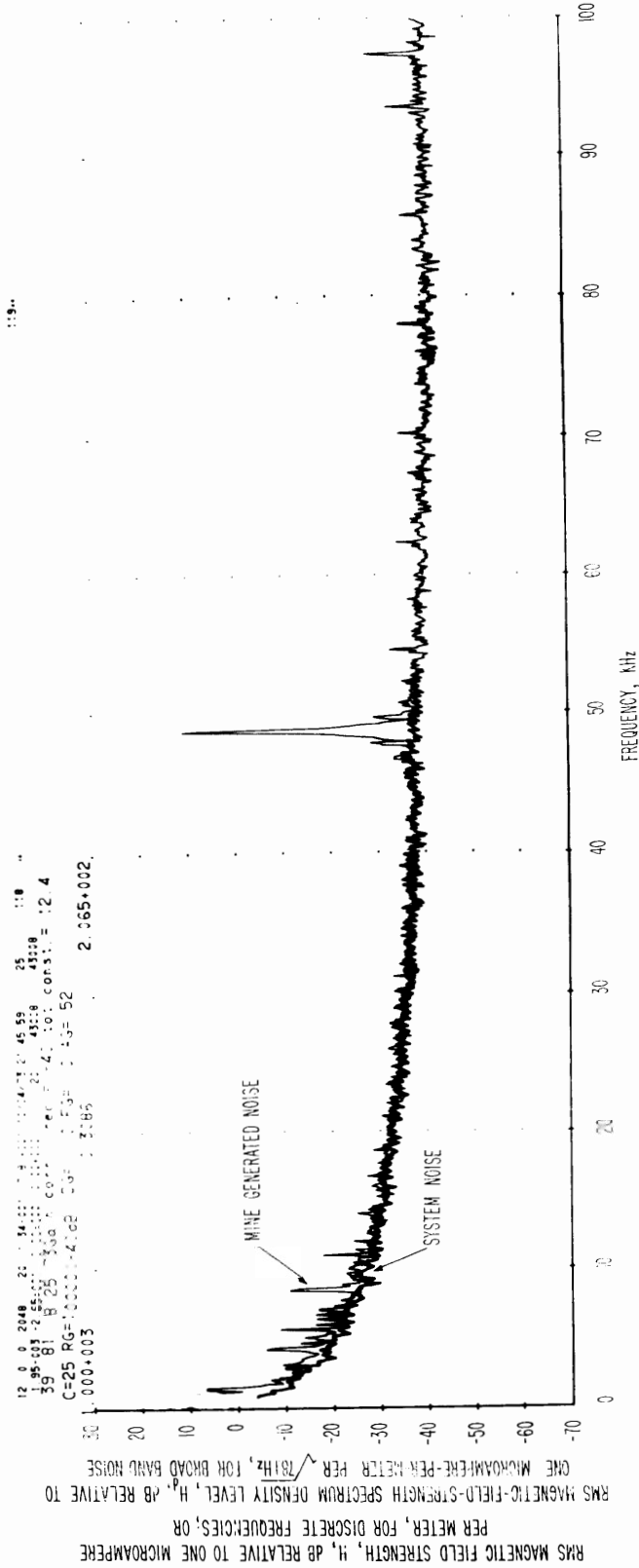

Figure 3-34 Spectrum of magnetic field strength obtained on a loop antenna 1 kHz to 100 kHz, Lucky Friday Mine, 4050 level, near face area, loop antenna adjacent to rail for maximum pickup, 10:45 a.m., August 25, 1973. Spectral resolution is 78.1 Hz.

12 0 0 2048 20 2.69+000 3.91+000 06/04/74 23:33:25 22 102
 1.95-003 -3.52+001 0.00+000 0.00+000 20 43008 43008
 21 118 8 25 74Gain corr., rec. = -40 tot const. = 12.4
 C=42 RG=10000 (-40dB) DG= 0 FG= 0 AG= 52
 1.000+005 0.3086 8.768+004

RMS MAGNETIC FIELD STRENGTH, H, DB RELATIVE TO ONE MICROAMPERE PER METER, FOR DISCRETE FREQUENCIES; OR
 RMS MAGNETIC-FIELD-STRENGTH SPECTRUM DENSITY LEVEL, H, DB RELATIVE TO ONE MICROAMPERE-PER-METER PER $\sqrt{3.91}$ Hz, FOR BROAD BAND NOISE

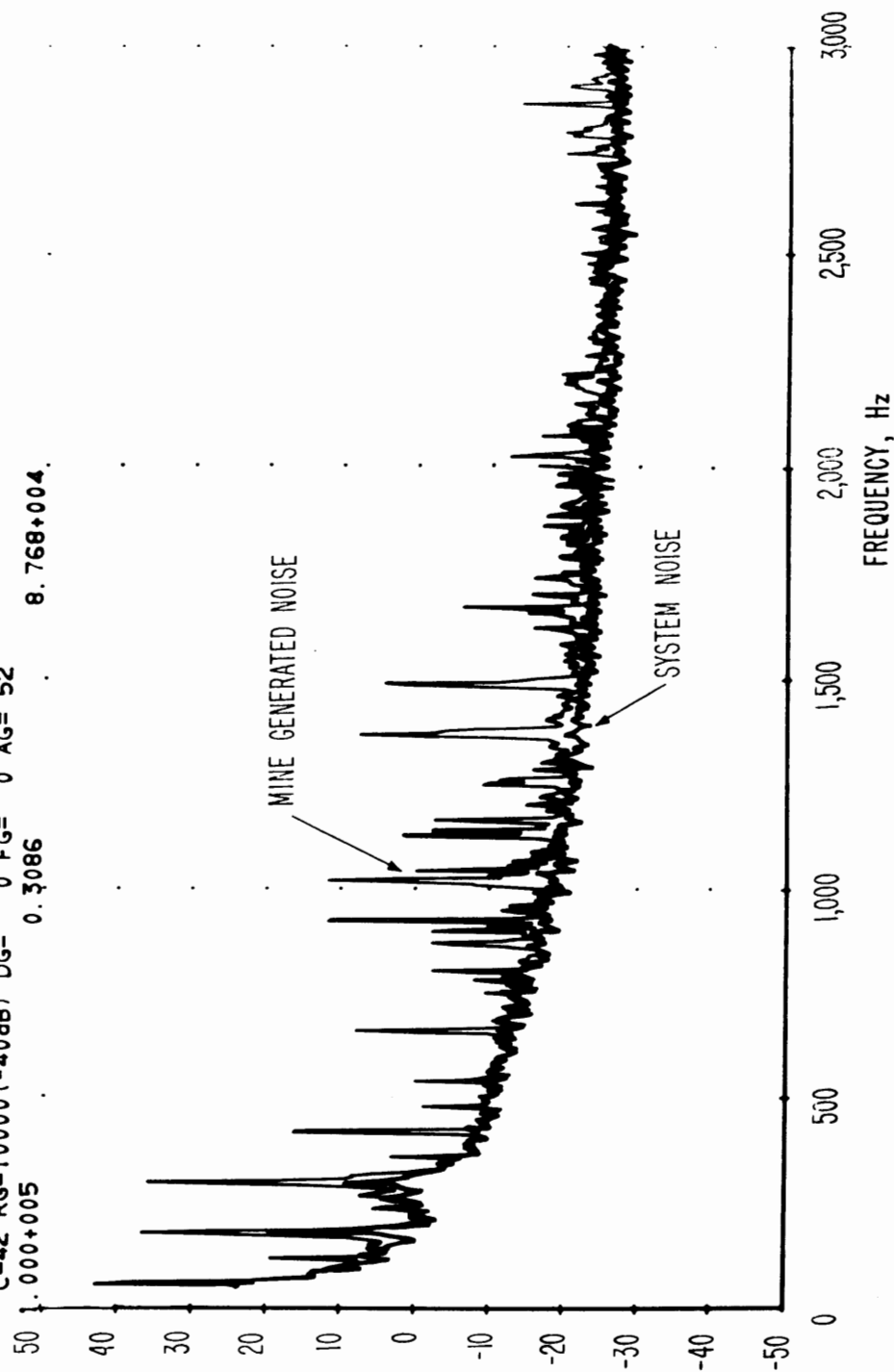

Figure 3-35 Spectrum of magnetic field strength obtained on a loop antenna 40 Hz to 3 kHz, Lucky Friday Mine, 4050 level, near face area, loop antenna adjacent to rail for maximum pickup, 10:45 a.m., August 25, 1973. Spectral resolution is 78.1 Hz.

RMS MAGNETIC FIELD STRENGTH, H, dB RELATIVE TO ONE MICROAMPERE PER METER, FOR DISCRETE FREQUENCIES; OR
 RMS MAGNETIC-FIELD-STRENGTH SPECTRUM DENSITY LEVEL, H_r, dB RELATIVE TO ONE MICROAMPERE-PER-METER PER $\sqrt{78.1\text{Hz}}$, FOR BROAD BAND NOISE

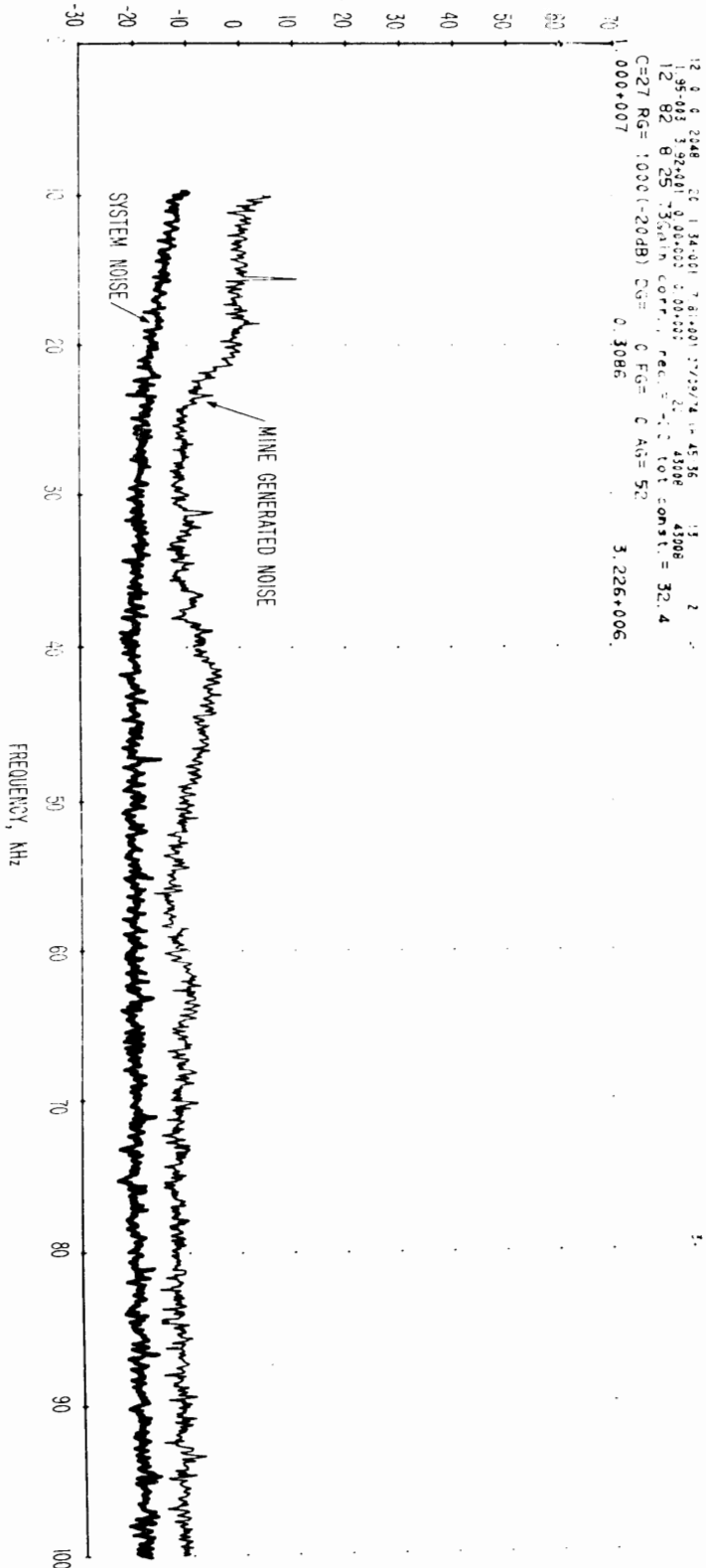

Figure 3-36

Spectrum of magnetic field strength obtained on a loop antenna, 10 kHz to 100 kHz, Lucky Friday Mine, antenna on top of elevator, zero level, mine not in operation, antenna sensitive axis horizontal E-W, 2:30 P.M., August 25, 1974. Spectral resolution is 78.1 Hz.

12 0 0 2046 32 1.31+001 1.81+001 17/09/73 18 55.37 26 66
 1.95+003 2.37+001 0.02+000 0.00+000 43008 43008
 25 82 8 25 336dm corr. rec. = -20 tot const. = 32.4
 C=27 RG= 1000 (-20dB) DG= 0 FG= 0 AG= 52
 1.000+007 0.3086 1.309+006

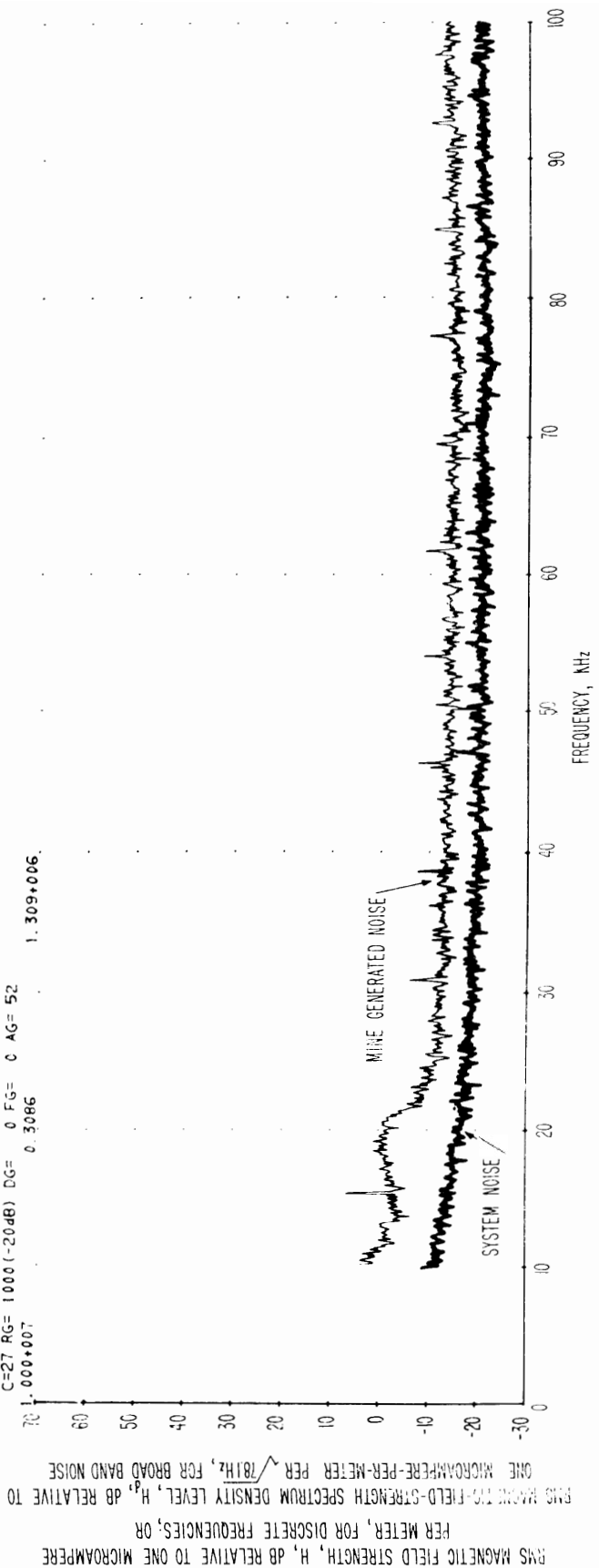

Figure 3-37 Spectrum of magnetic field strength obtained on a loop antenna, 10 kHz to 100 kHz, Lucky Friday Mine, antenna on top of elevator, 4050 level, mine not in operation, antenna sensitive axis horizontal E-W, 2:34 p.m., August 25, 1974. Spectral resolution is 78.1 Hz.

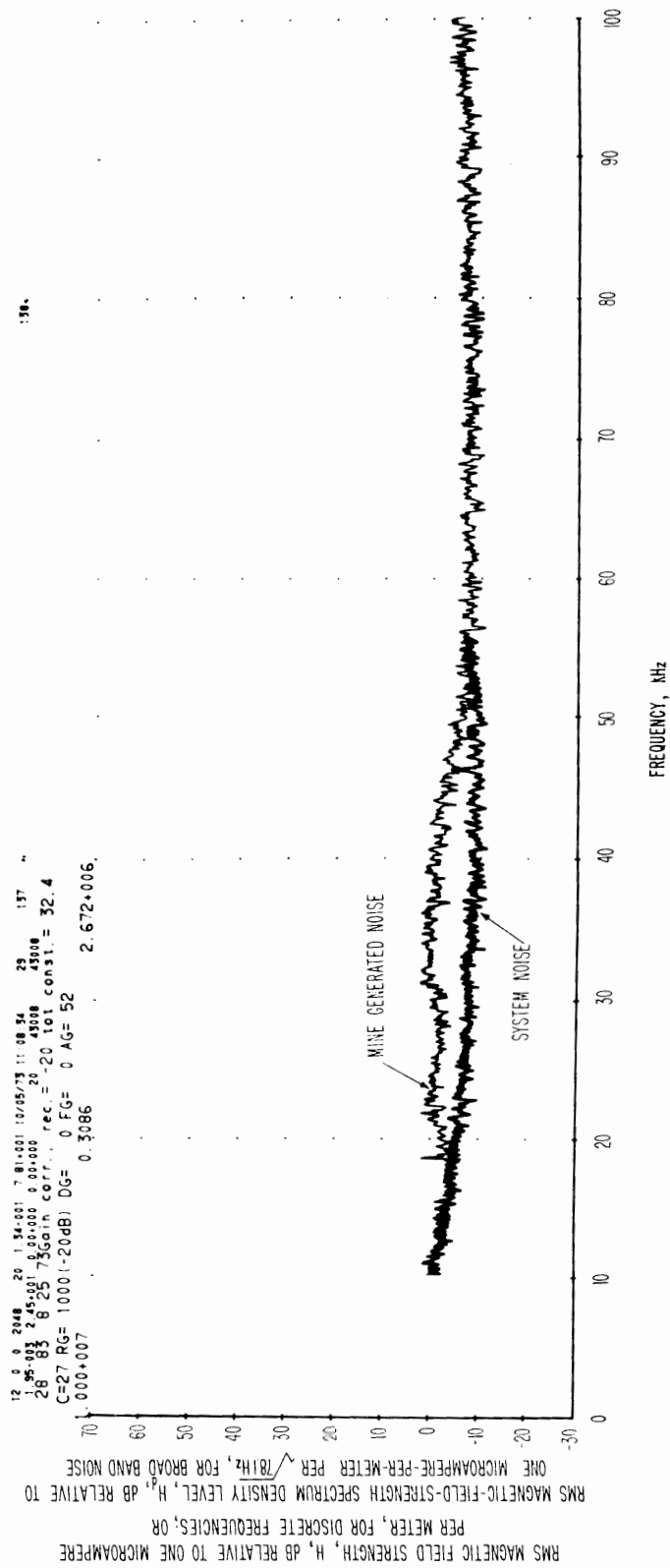

Figure 3-38 Spectrum of magnetic field strength obtained on a loop antenna 10 kHz to 100 kHz, Lucky Friday Mine, preliminary run just before starting down elevator shaft, antenna sensitive axis horizontal (E-W), zero level, mine in operation, 12:47 p.m., August 27, 1973. Spectral resolution is 78.1 Hz.

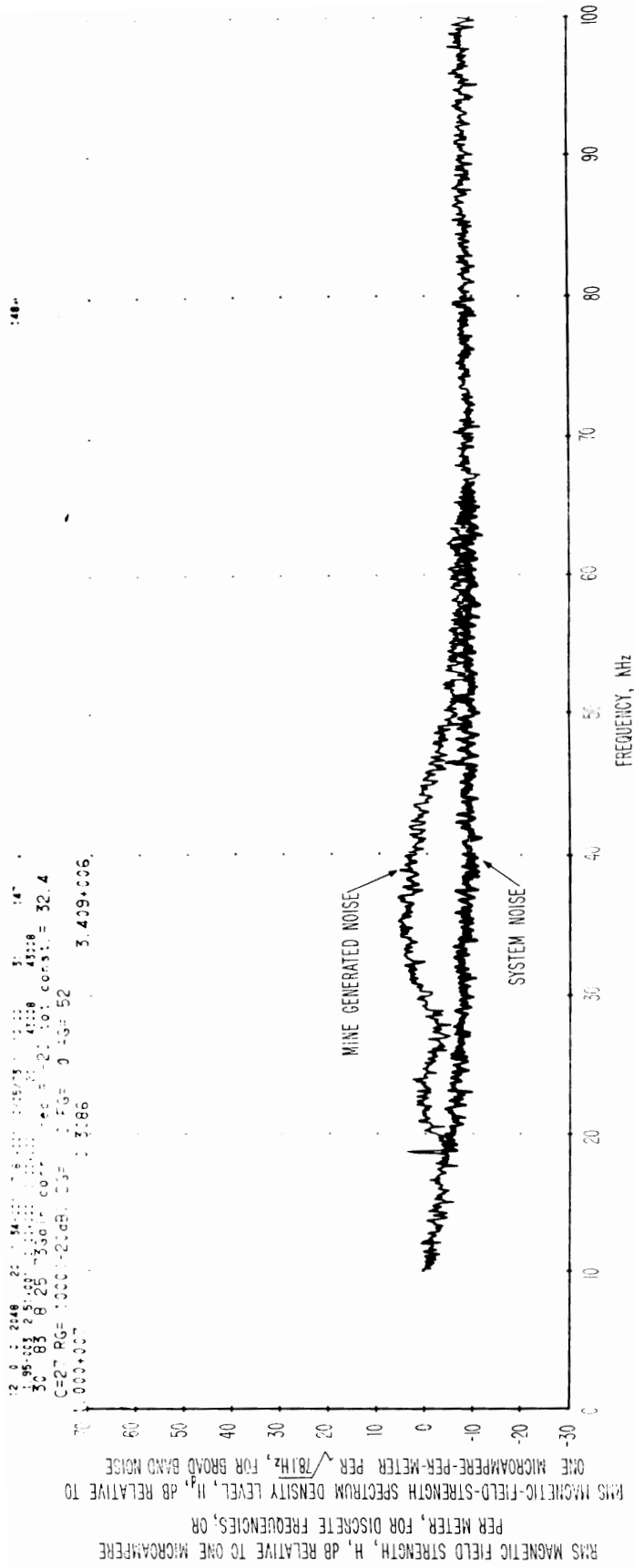

Figure 3-39 Spectrum of magnetic field strength obtained on a loop antenna 10 kHz to 100 kHz, Lucky Friday Mine, 150 level, mine in operation, antenna sensitive axis horizontal (E-W), August 27, 1973. Spectral resolution is 78.1 Hz.

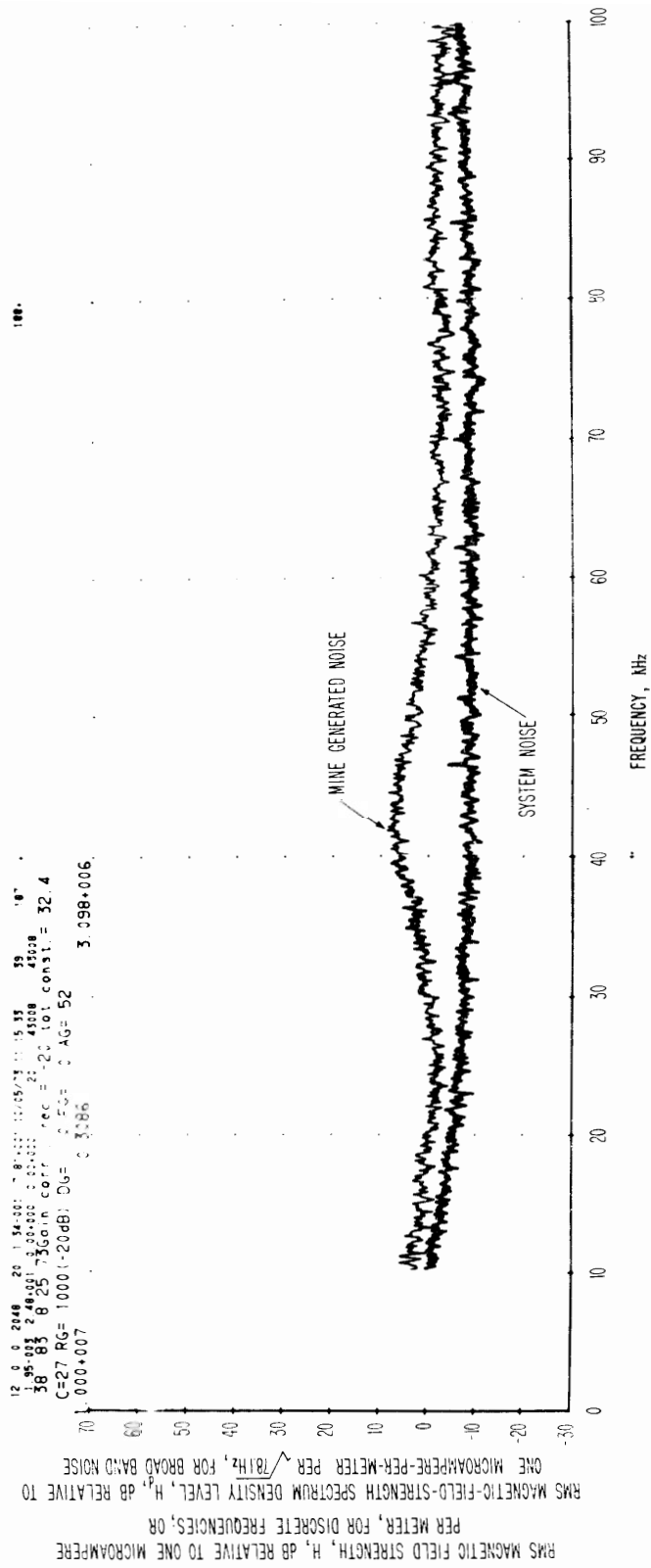

Figure 3-40 Spectrum of magnetic field strength obtained on a loop antenna 10 kHz to 100 kHz, Lucky Friday Mine, 1450 level (470 meters deep), mine in operation, antenna sensitive axis horizontal (E-W), August 27, 1973. Spectral resolution is 78.1 Hz.

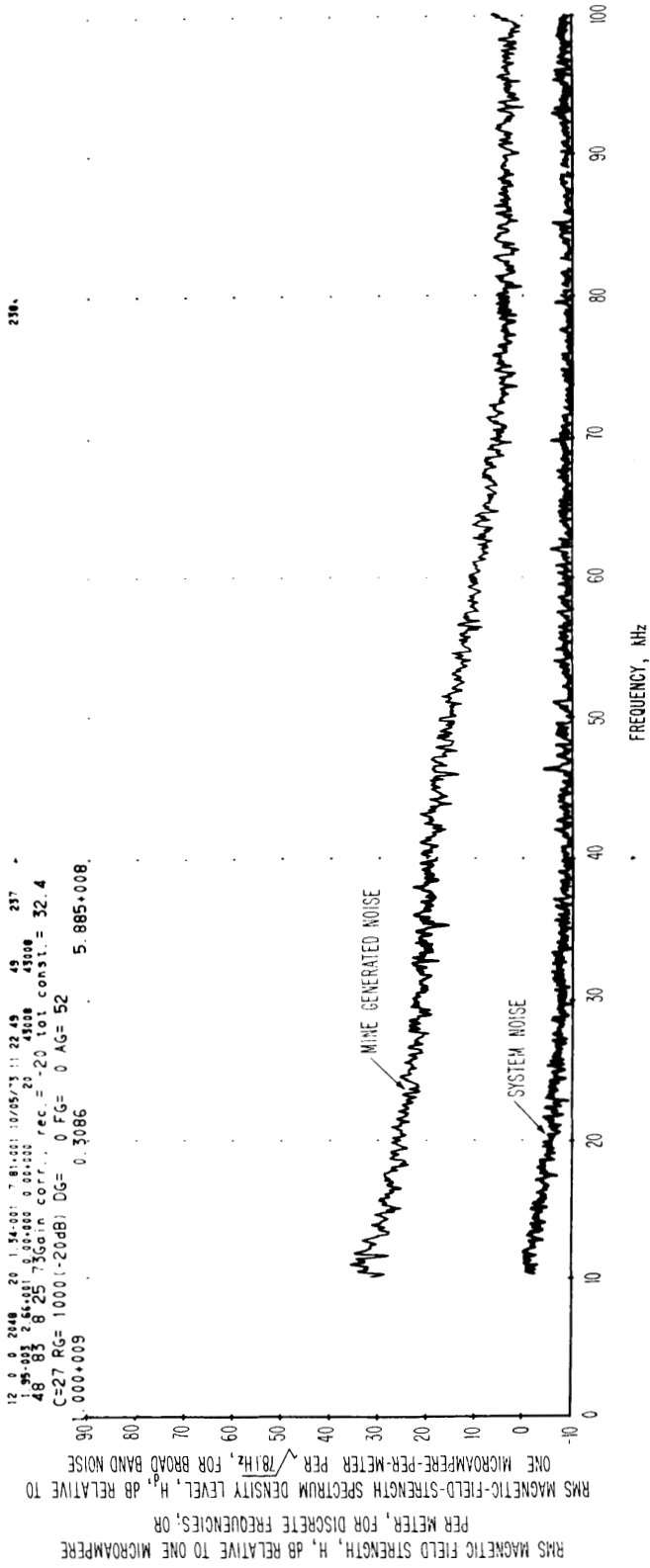

Figure 3-41 Spectrum of magnetic field strength obtained on a loop antenna 10 kHz to 100 kHz, Lucky Friday Mine, 3400 level (1080 meters deep), mine in operation, antenna sensitive axis horizontal (E-W), August 27, 1973. Spectral resolution is 78.1 Hz.

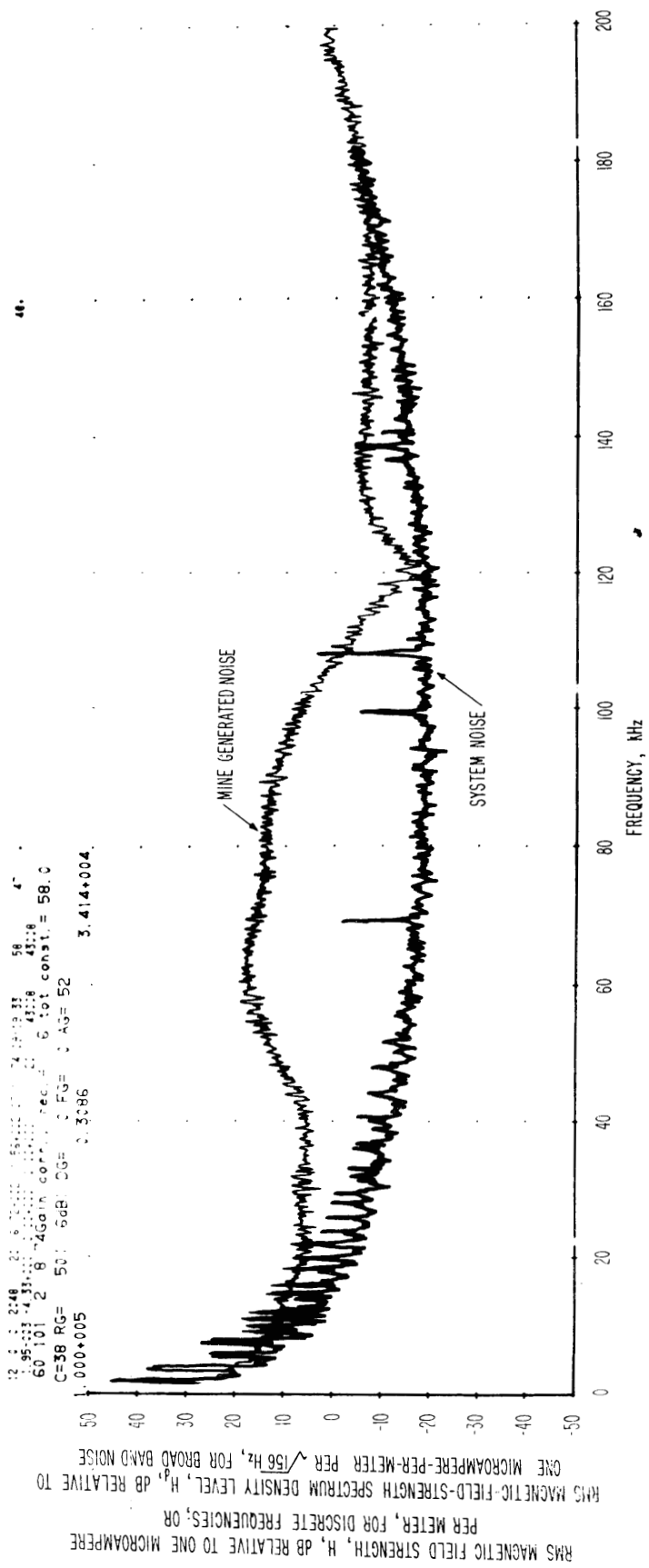

Figure 3-42 Spectrum of magnetic field strength obtained from a loop antenna, sensitive axis horizontal (East-West), location on top of cage adjacent to hoist rope, Lucky Friday Mine. Time is about 11:00 a.m., February 8, 1974. Calibration is valid over the frequency range from 3 kHz to 200 kHz. Cage is at 4250 level. Signal is from a strong unknown source.

12 05 2 0248 25 6 75 222 1 564122 13/19/74 21 15 37 56 2 2
 59 10 2 8 74 gain corr. rec. = 20 101 const. = -29.0
 C=36 RG= 101 20dB DG= 0 FG= 0 AG=-49
 000-006 0.3086 7.531-007

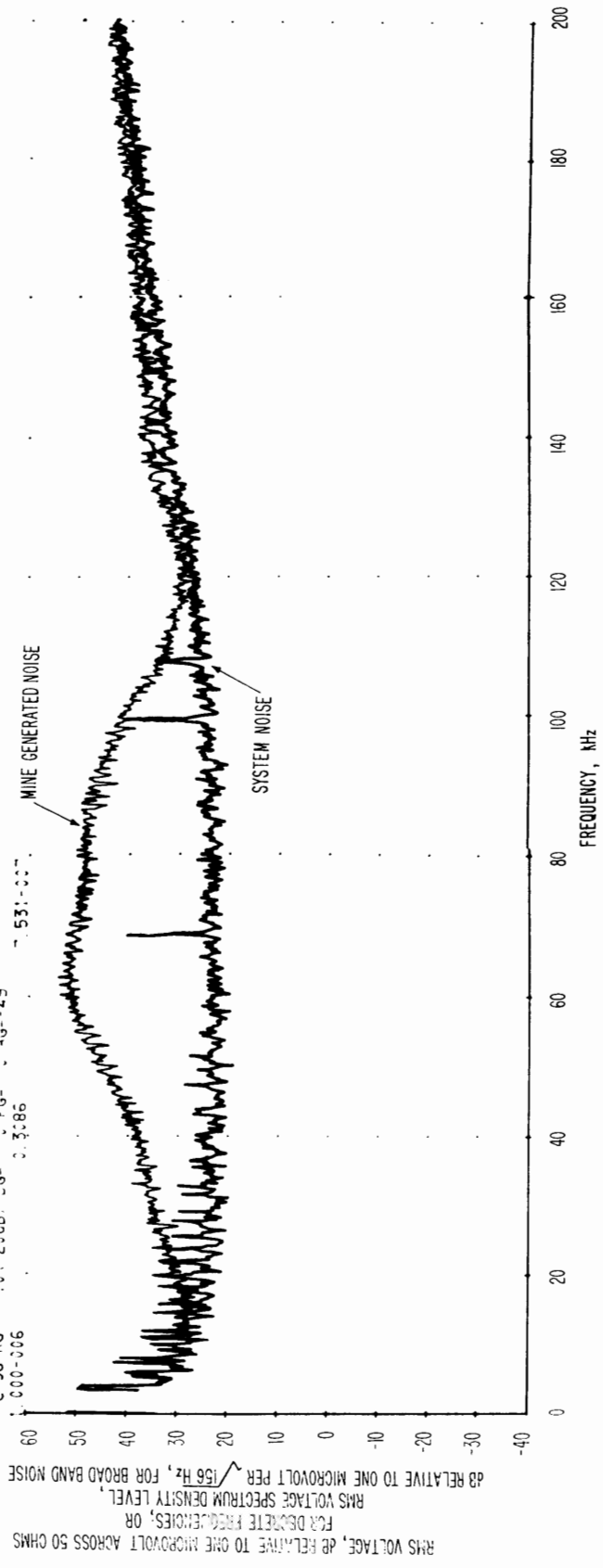

Figure 3-43 Spectrum of voltage across a 50 ohm load. The source of the voltage is a ferrite loop around the hoist rope; the loop is about 2 meters above the cage. The calibration is valid from 3 kHz to 200 kHz. Location is the Lucky Friday Mine. Time was about 11:00 a.m., February 8, 1974. Cage was at 4250 level. Signal is from a strong unknown source.

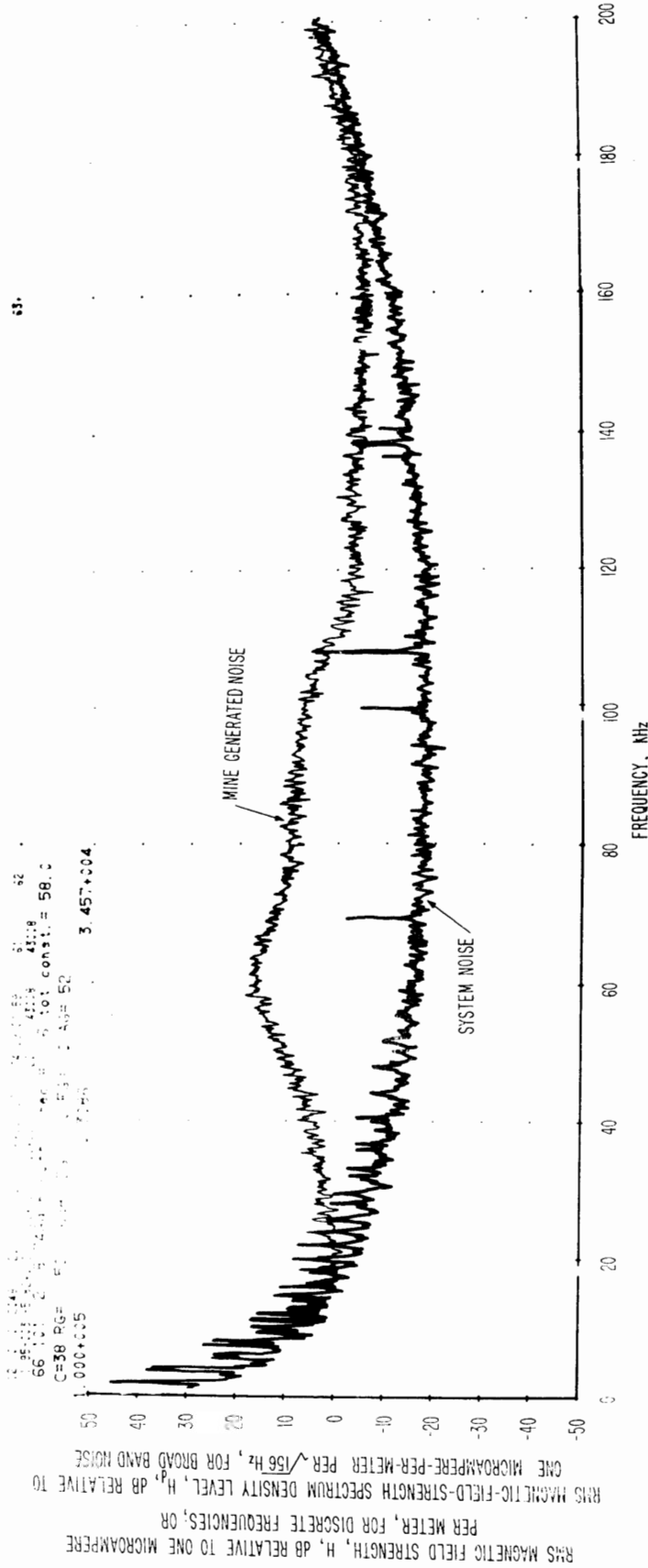

Figure 3-44 Spectrum of magnetic field strength obtained from a loop antenna, sensitive axis horizontal (East-West), location on top of cage adjacent to hoist rope. Lucky Friday Mine. Time is about 11:00 a.m., February 8, 1974. Calibration is valid over the frequency range from 3 kHz to 200 kHz. Cage is at 4250 level. Signal is from a strong unknown source.

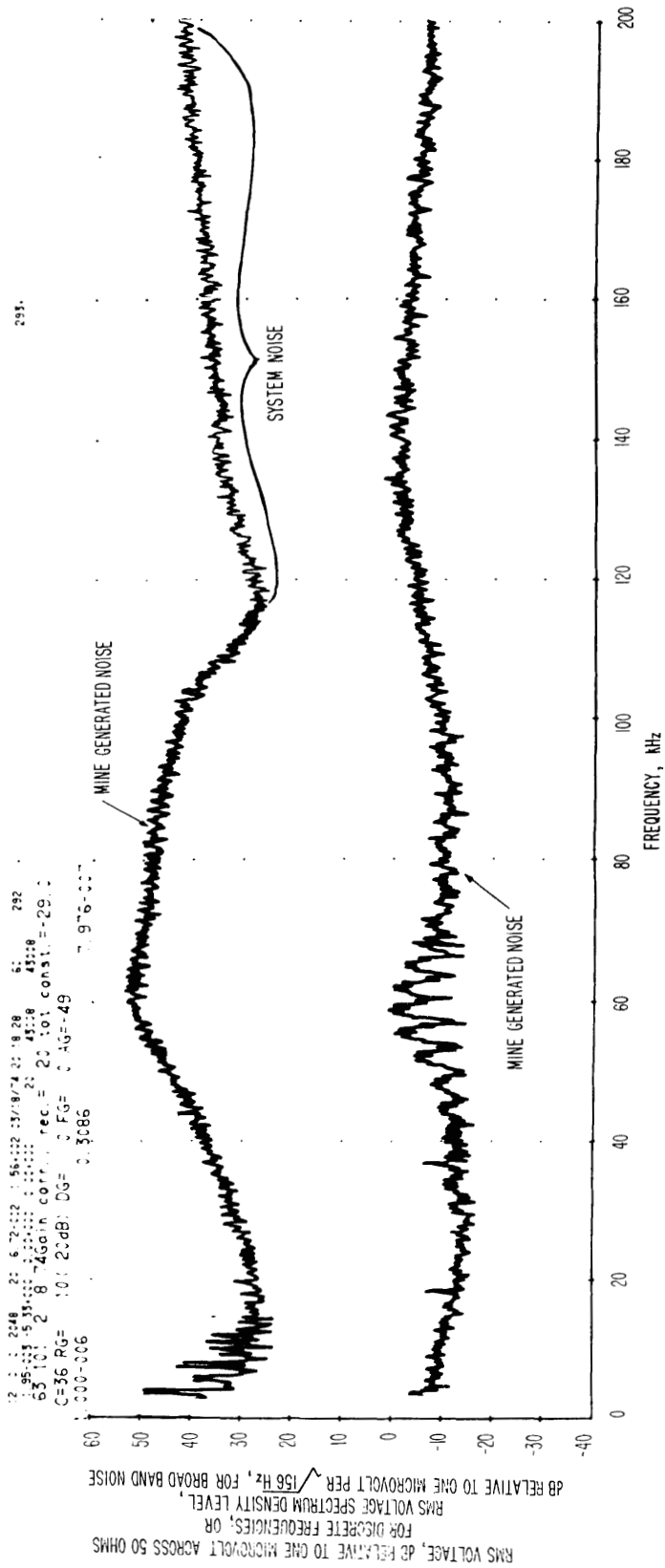

Figure 3-45 Spectrum of voltage across a 50 ohm load. The source of the voltage is a ferrite loop around the hoist rope; the loop is about 2 meters above the cage. The calibration is valid from 3 kHz to 200 kHz. Location is the Lucky Friday Mine. Time was about 11:00 a.m., February 8, 1974. The upper curve is a strong unknown source and the lower curve is typical noise during mining operation.

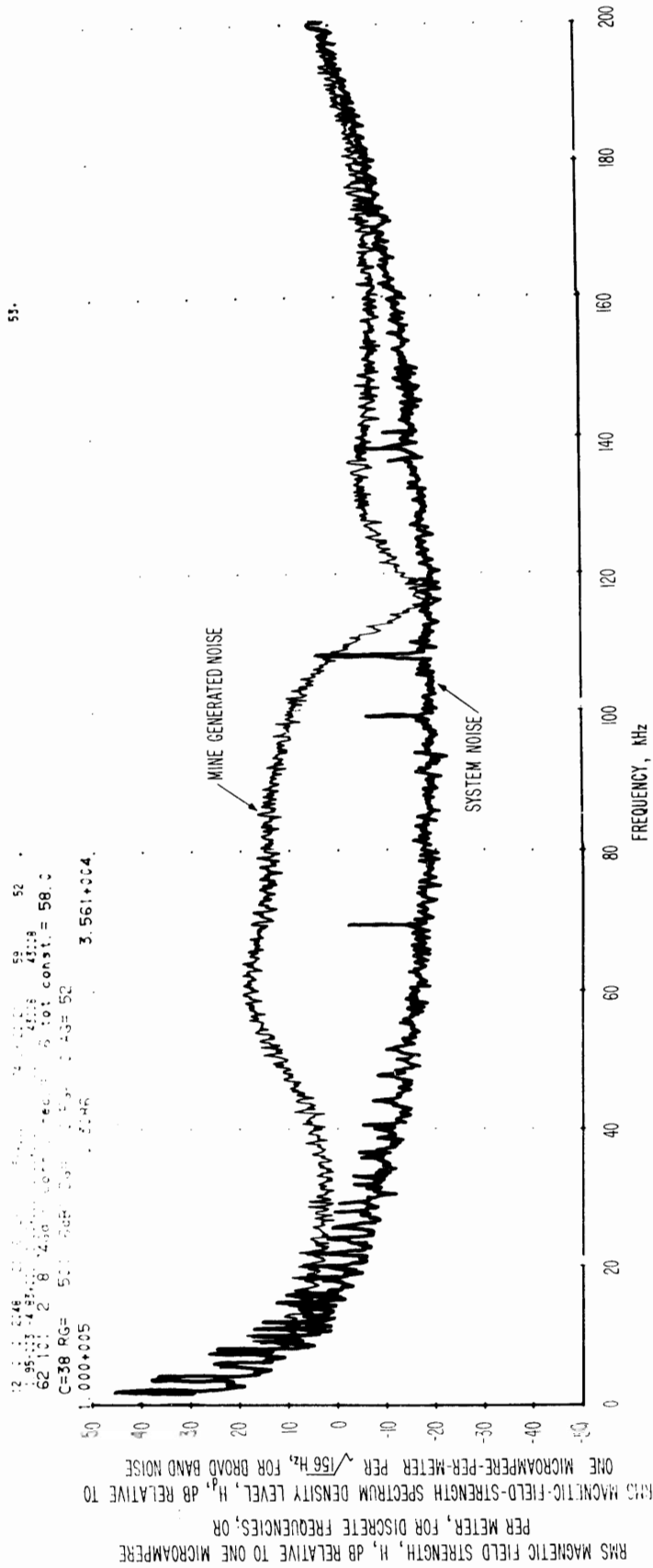

Figure 3-46 Spectrum of magnetic field strength obtained from a loop antenna, sensitive axis horizontal (East-West), location on top of cage adjacent to hoist rope, Lucky Friday Mine. Time is about 11:00 a.m., February 8, 1974. Calibration is valid over the frequency range from 3 kHz to 200 kHz. Cage is at 4250 level. Signal is from a strong unknown source.

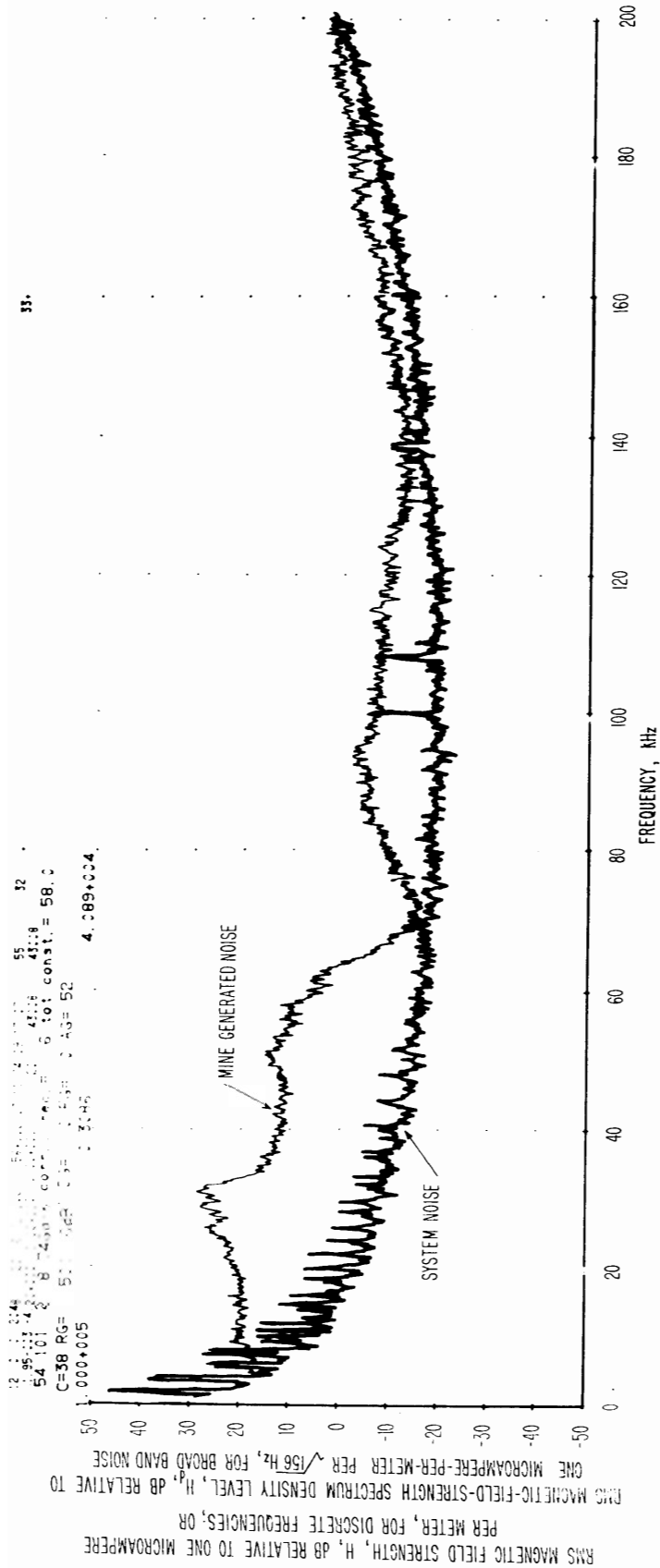

Figure 3-47 Spectrum of magnetic field strength obtained from a loop antenna, sensitive axis horizontal (East-West), location on top of cage adjacent to hoist rope, Lucky Friday Mine. Time is about 11:00 a.m., February 8, 1974. Calibration is valid over the frequency range from 3 kHz to 200 kHz. Cage is at 4250 level. Signal is from short-duration impulsive source.

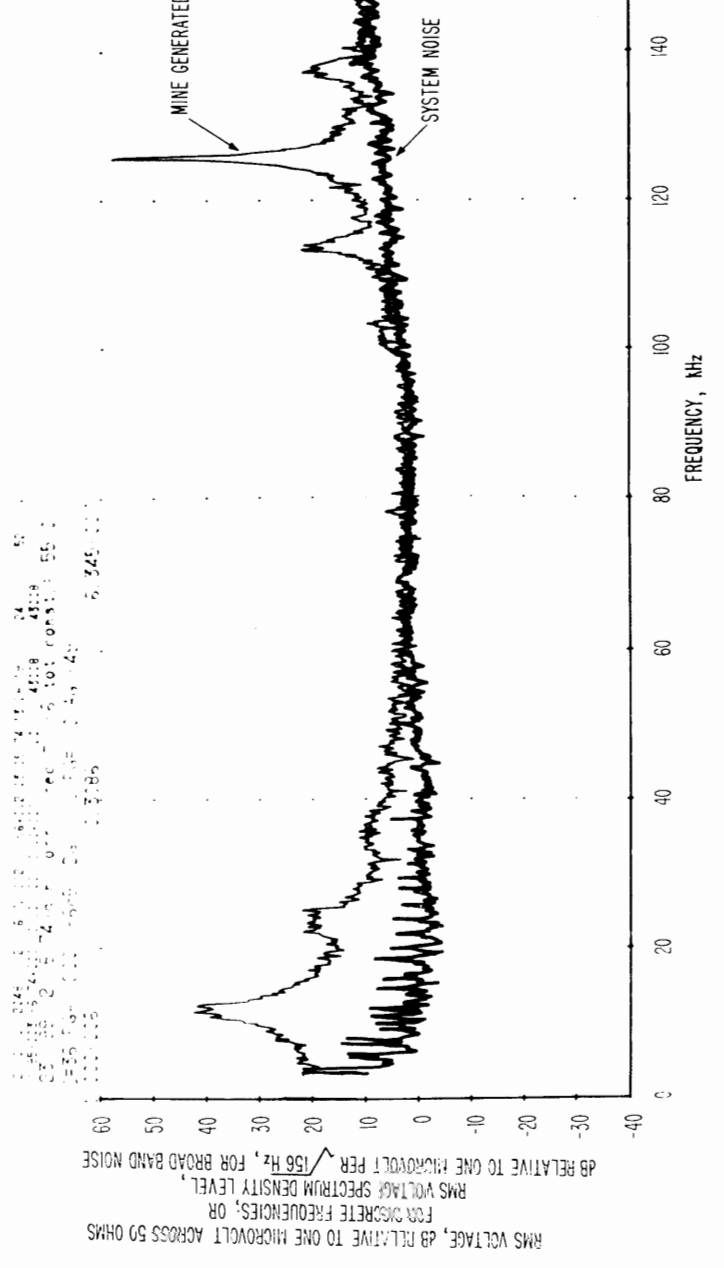

Figure 3-48 Spectrum of voltage across a 50 ohm load. The source of the voltage is a ferrite loop around the hoist rope; the loop is about 2 meters above the cage. The calibration is valid from 3 kHz to 200 kHz. Location is the Lucky Friday Mine. Time was about 11:00 a.m., February 8, 1974. Cage was at 1600 level. Signals are from an unknown narrowband source.

12 2 2:48 21 6.70000 1.55000 1.00000 22 1:2
 21 97 2 8 74Gain corr. rec. = -6 tot const. = -55.0
 C=36 RG= 200 (-6dB) CG= 3 FG= 3 AG=-49
 1.000-005 1.3086 1.239-006

33

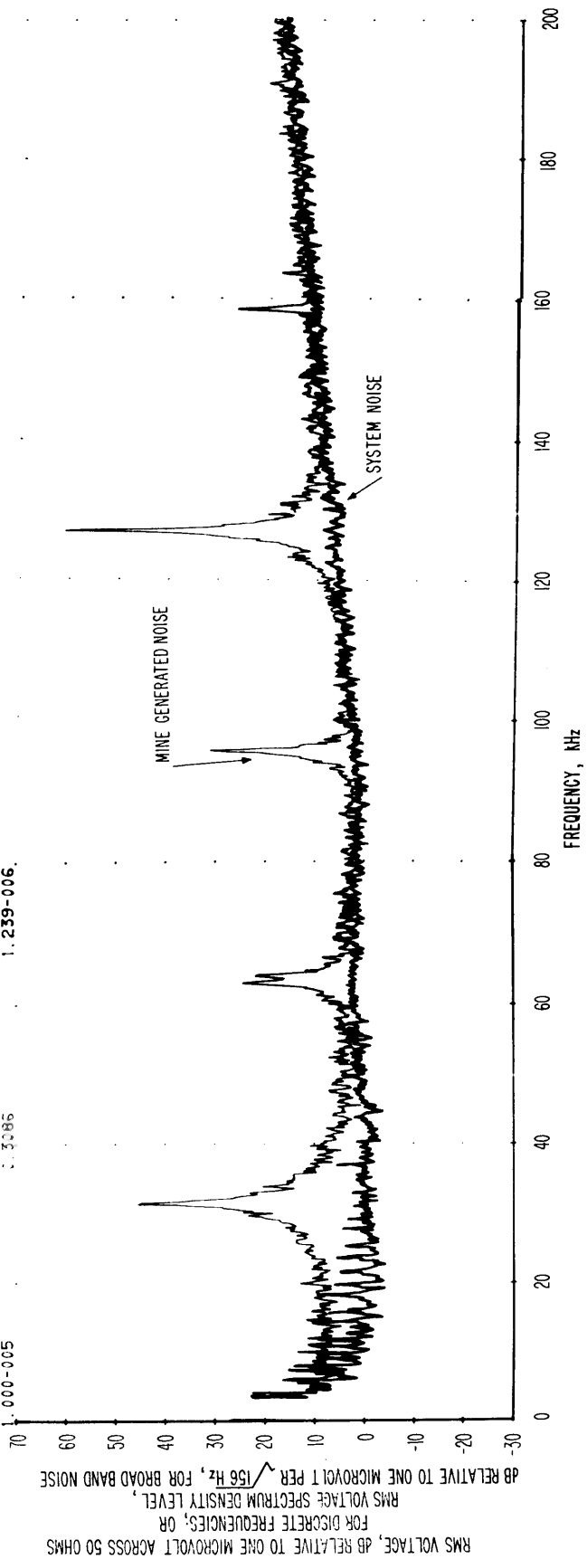

Figure 3-49 Spectrum of voltage across a 50 ohm load. The source of the voltage is a ferrite loop around the hoist rope; the loop is about 2 meters above the cage. The calibration is valid from 3 kHz to 200 kHz. Location is the Lucky Friday Mine. Time was about 11:00 a.m., February 8, 1974. Cage was at 1800 level. Signals are from an unknown narrowband source.

12 0245 01 5 35000 13/2/74 01 18.49 8 32
 135003 515000 100000 43008
 33 2 8 74000 000000 rec 5 101 const = 58.4
 C=2: 53= 501 568 53= 153 146= 52
 0000004 3035 4.199*003

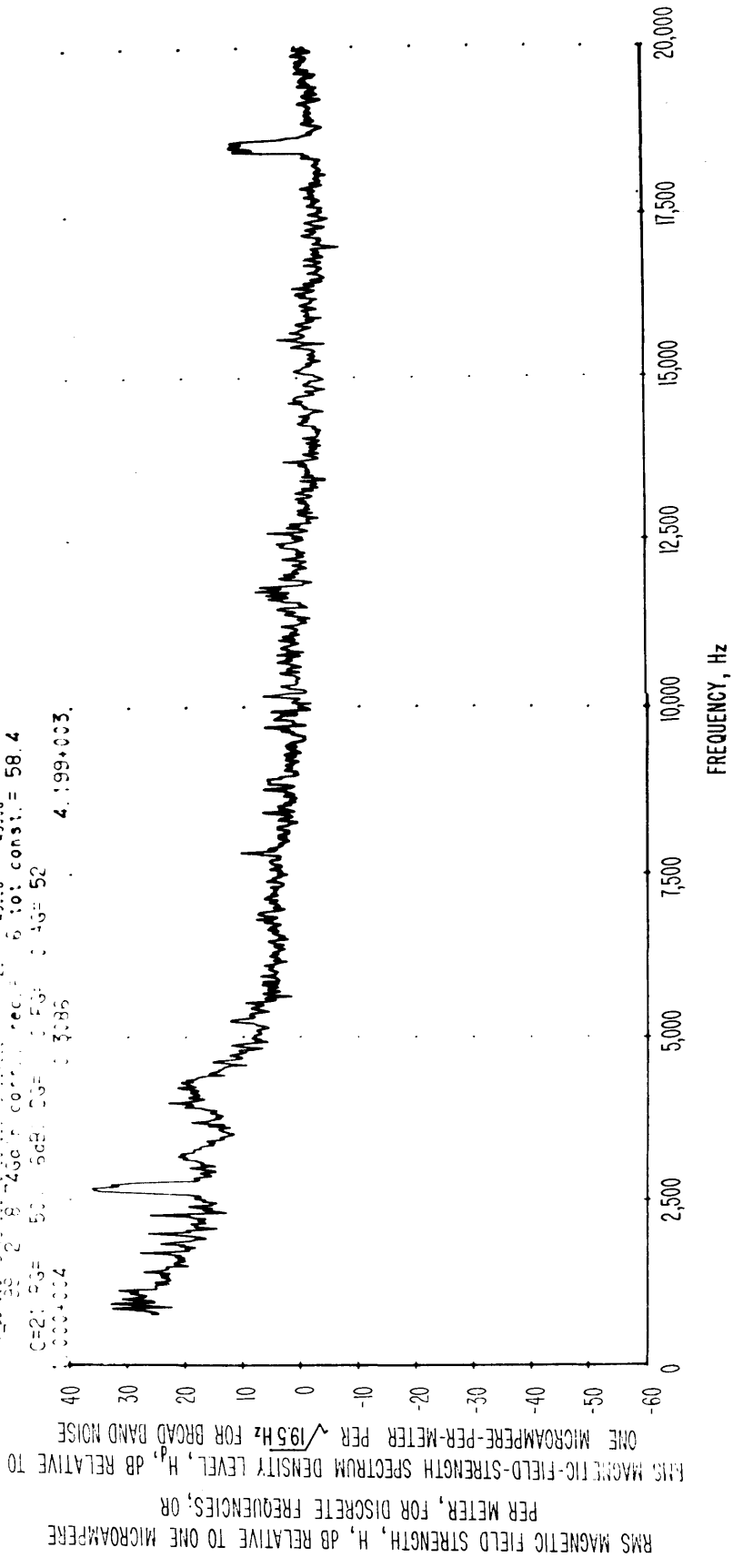

Figure 3-50 Spectrum of magnetic field strength obtained from a loop antenna located on top of cage. Calibration is valid from 750 Hz to 20 kHz. Location was 1800 level of Lucky Friday Mine. Time was about 11:00 a.m., February 8, 1974.

4. AMPLITUDE PROBABILITY DISTRIBUTION MEASUREMENTS

4.1 Introduction and Uncertainties

The amplitude probability distribution (APD) of the received noise signal magnitude is one of the most useful statistical descriptions of the noise process for the design and evaluation of a telecommunications system operating in a noisy environment [5,6,7].

By plotting the cumulative APD on Rayleigh graph paper, one can show clearly the fraction of time that noise exceeds various levels. Rayleigh graph paper is chosen with scales so that Gaussian noise (e.g., thermal noise) plots as a straight line with slope of $-1/2$. Noise with rapid large changes in amplitude (e.g., impulsive noise) then has a much steeper slope, typically -4 or -5 , depending on the receiver bandwidth.

All APD measurements are reported in absolute quantities.

The estimated limits of error for the APD noise measurements are ± 5 dB. Several sources of error that are critical to the overall accuracy of our measurements are listed below:

1. Use of a discrete, digital level counter (levels are 6 dB apart) contributes ± 1 -dB quantization error limit. One-decibel step attenuators are used to achieve the \pm one decibel.
2. The system, i.e., recording, data transcribing, and data processing, has a calibration uncertainty of ± 0.5 dB [3].
3. The estimated uncertainty involved in using the portable and the laboratory tape recorders for record and playback is ± 0.5 dB due to harmonic distortion, flutter, dropout, cross-talk, gain instability, etc.

4. The gain instability during measurements, gain changes between measurements and calibration, and the non-linearity of electromagnetic interference and field strength (EIFS) meters and mixers, all combined, contribute ± 0.5 dB uncertainty.

5. The gain instability and non-linearity of the digital level counter, the tuned frequency converter, the amplifier, and attenuators, all combined, contribute ± 0.5 dB uncertainty.

6. Connector losses and BNC cable losses, particularly at higher frequencies above 100 kHz, contribute ± 2.0 dB uncertainty.

4.2 Results

APD measurements were made on August 27, 1973, and on February 8, 1974, during operation in the Lucky Friday Mine located near Wallace, Idaho. Descriptions of the Lucky Friday Mine are given in section 1.2. APD measurements were made at four locations. The first set of APD measurements at four frequencies was made on August 27 at the head-frame on the surface. APD's are shown in figures 4-1 through 4-9 for two antenna orientations. The second set of APD measurements at four frequencies was made on August 27, 1973, at the 1450 foot (427 m) level. These APD's are shown in figures 4-9 through 4-16. The third set of APD measurements at three frequencies was made on August 27, 1973, at the 3050 foot (930 m) level. APD's are shown in figures 4-17 through 4-22. In these sets of APD measurements, both the vertical and horizontal components of magnetic field were measured. The fourth set of APD measurements at three frequencies was made on February 8, 1974, at the 3650 foot (1113 m) level, during operation. The 3650 level was a working level with light activity. APD's are shown in figures 4-23 through 4-28.

In all cases except for the 3650 working level, the horizontal component is about 10 dB stronger than the vertical component. This is probably because the horizontal orientation of the antenna coupled more strongly to the nearby hoist ropes (the apparent source of noise) than did the vertical orientation. At the working level, the strongest noise source was not the hoist ropes but was machinery at the level. Somewhat higher levels were also measured at the 3650 level than at other levels. Whether the 20 minute time interval for each recording was sufficient for statistical validity needs to be determined from further analysis.

Also, at the 3650 level, the noise amplitude tended to increase with increasing frequency, while at all other locations at this mine, it tended to decrease with increasing frequency.

4.3 RMS and Average Values

The APD's are integrated to give rms and average values of the field strength, according to the equations

$$H_{\text{avg}} = - \int_0^{\infty} H \, dp(H)$$

and

$$H_{\text{rms}} = \left(- \int_0^{\infty} H^2 \, dp(H) \right)^{\frac{1}{2}},$$

where H represents the magnetic field strength of the noise, and p is the probability that the measured field strength exceeds the value H. These quantities are also dependent upon the measurement bandwidth, the length of the data run, and possibly other parameters. Finite series are used for the numerical integration. The rms and average values so

arrived at are identified on each graph and are time averages (23 minutes) of these time-dependent parameters. If the tapes are played into ordinary rms-reading meters, the meter readings will vary 10 to 20 dB over fractions of a second. The rms value is directly relatable to noise power. With these wide variations of field strength with time, the most suitable presentations are statistical ones.

4.4 Summary Curves

Excursions of field strength between 0.001 and 99 percent, as well as rms and average values, are shown in figures 4-29 through 4-36. The predetection bandwidth for these APD measurements is either 1 kHz or is normalized to 1 kHz.

Figure 4-29 is a summary of the figures 4-1 through 4-4, at the headframe, the horizontal (N-S) component. Figure 4-30 is a summary of figures 4-5 through 4-8, at the headframe, vertical component. Figure 4-31 is a summary of figures 4-9 through 4-12, at the 1450-foot level, vertical component. Figure 4-32 is a summary of figures 4-13 through 4-16, at the 1450-foot level, horizontal (N-S) component. Figure 4-33 is a summary of figures 4-17 through 4-19, at the 3050-foot level, horizontal (N-S) component. Figure 4-34 is a summary of figures 4-20 through 4-22, at the 3050-foot level, vertical component. Figure 4-35 is a summary of figures 4-23 through 4-25, at the 3650-foot level, horizontal (N-S) component. Figure 4-36 is a summary of figures 4-26 through 4-28, at the 3650-foot level, vertical component.

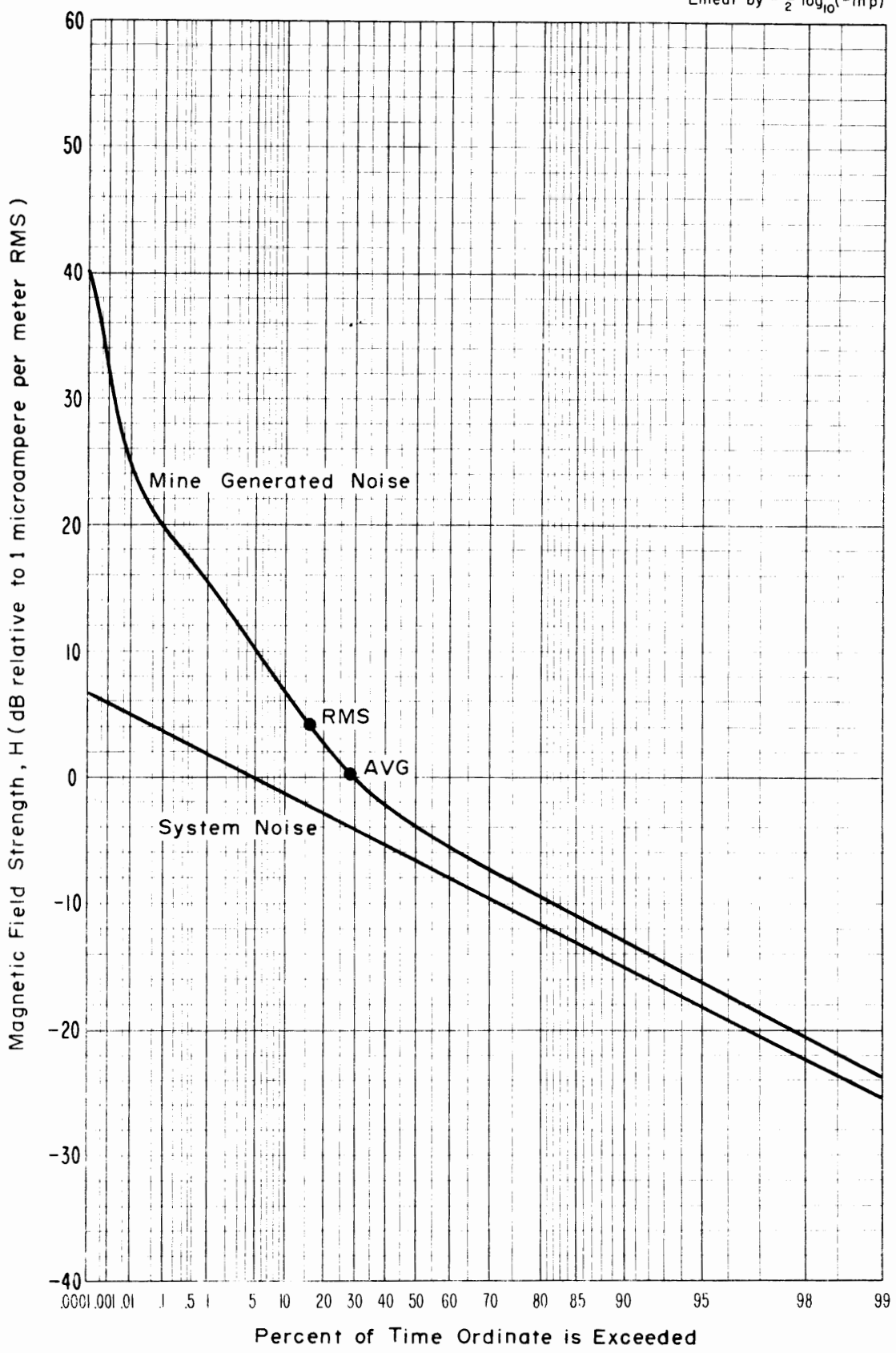

Figure 4-1 APD, Magnetic field strength, 30 kHz, Horizontal (North-South) component, Headframe, Lucky Friday Mine, 1 kHz predetection bandwidth. Time was 11:00 a.m., August 27, 1973.

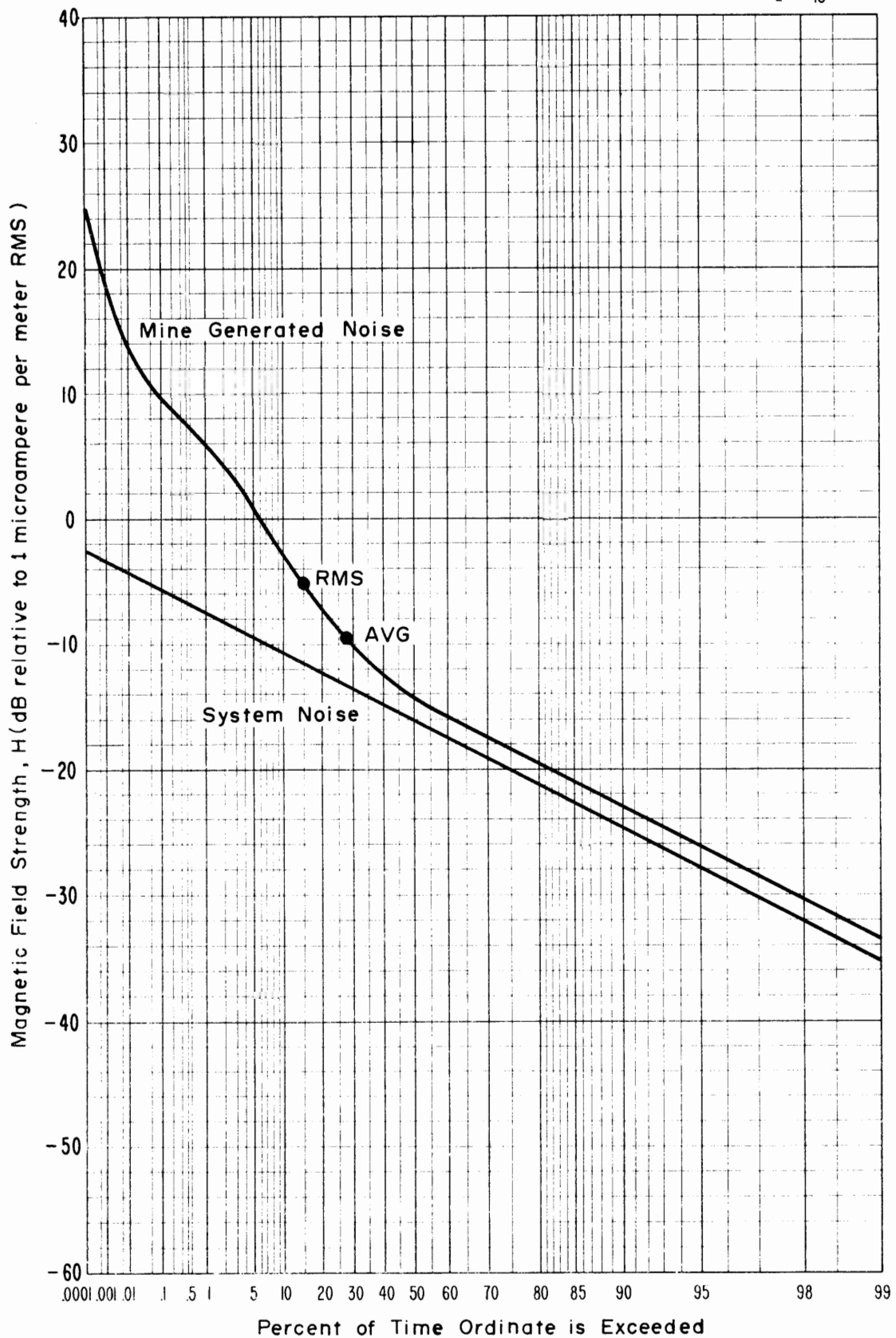

Figure 4-2 APD, Magnetic field strength, 70 kHz, Horizontal (North-South) component, Headframe, Lucky Friday Mine, 1 kHz predetection bandwidth. Time was 11:00 a.m., August 27, 1973.

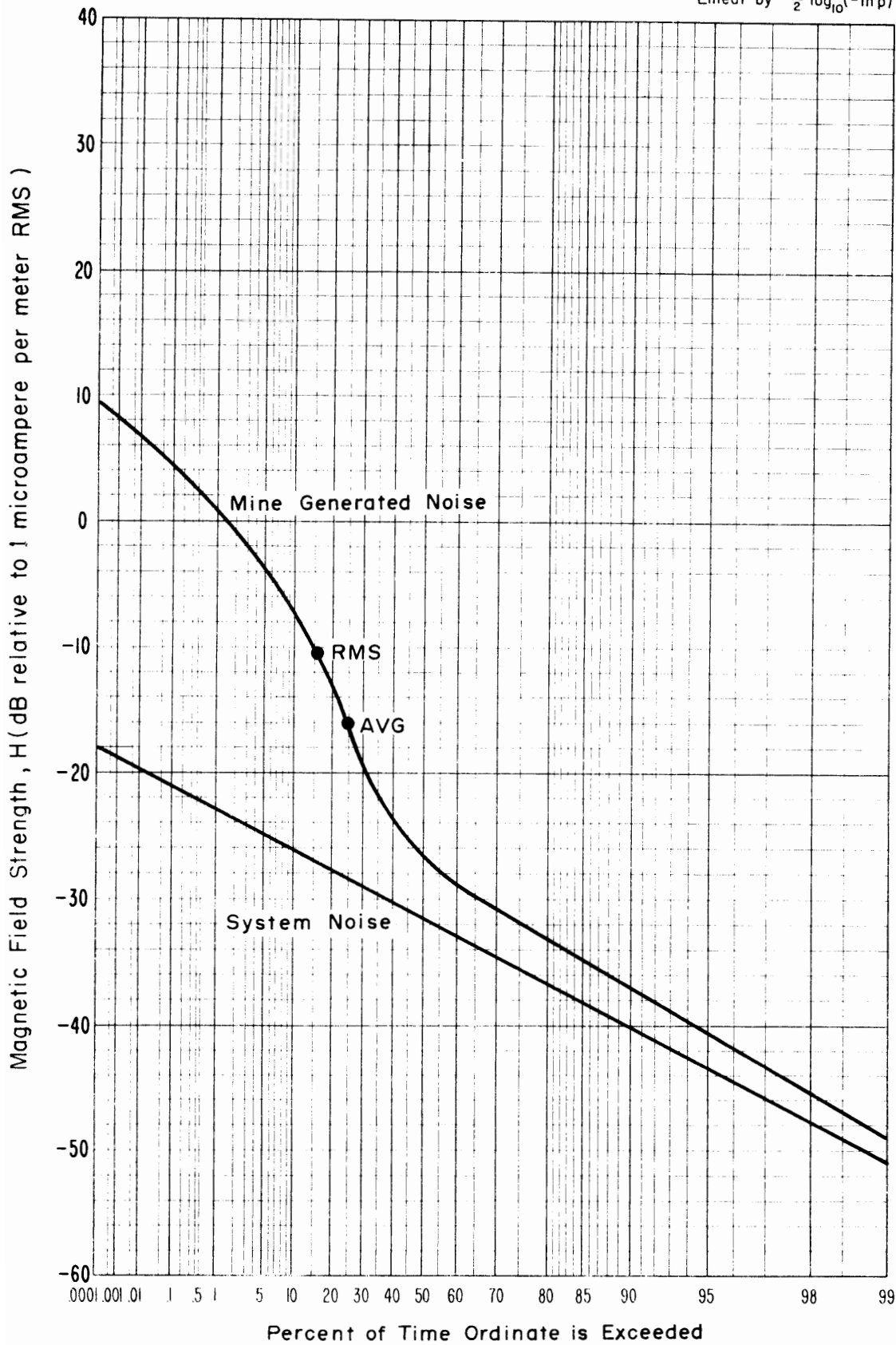

Figure 4-3 APD, Magnetic field strength, 150 kHz, Horizontal (North-South) component, Headframe, Lucky Friday Mine, 1.2 kHz predetection bandwidth. Time was 11:00 a.m., August 27, 1973.

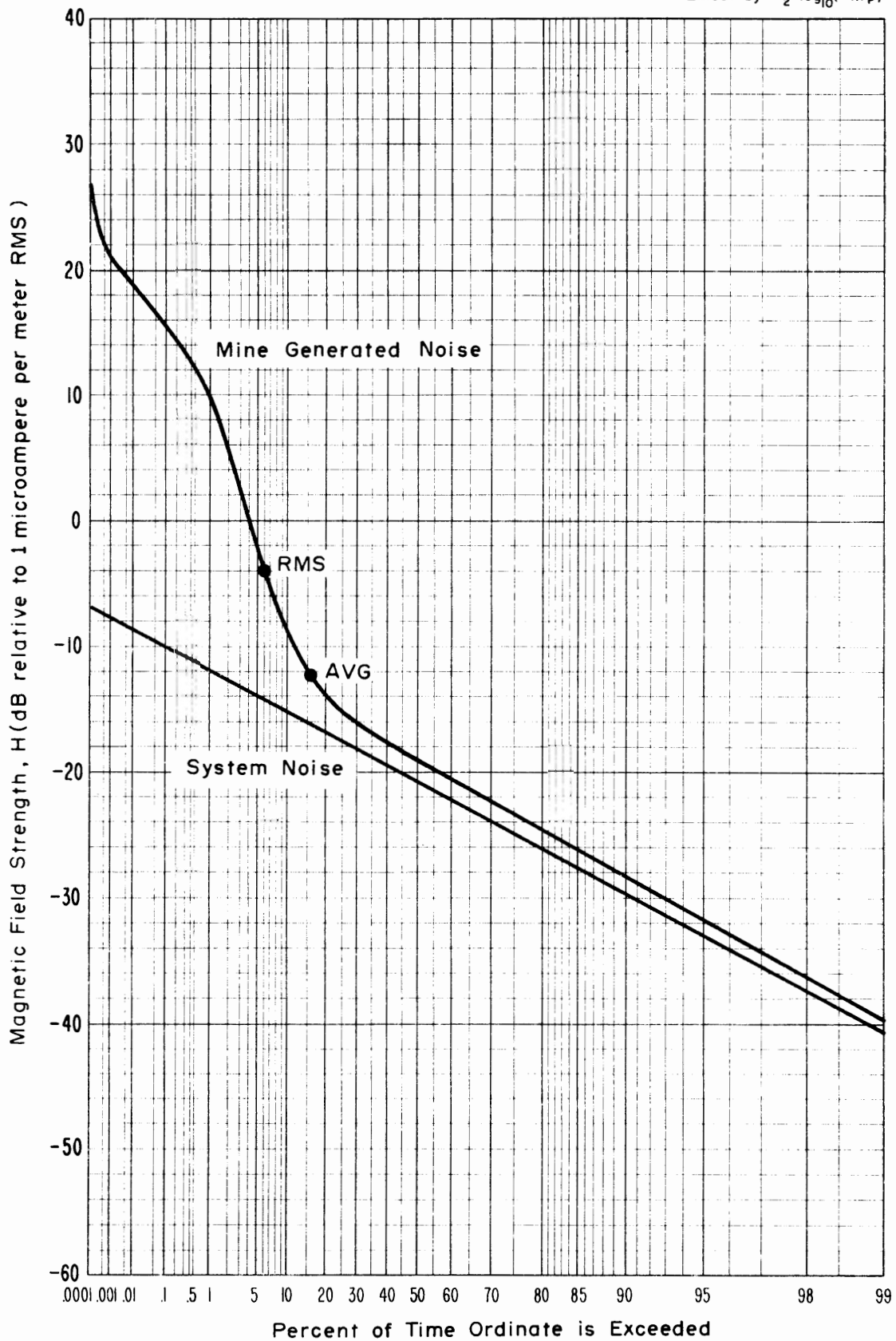

Figure 4-4 APD, Magnetic field strength, 250 kHz, Horizontal (North-South) component, Headframe, Lucky Friday Mine, 1.2 kHz predetection bandwidth. Time was 11:00 a.m., August 27, 1973

Linear by $-\frac{1}{2} \log_{10}(-\ln p)$

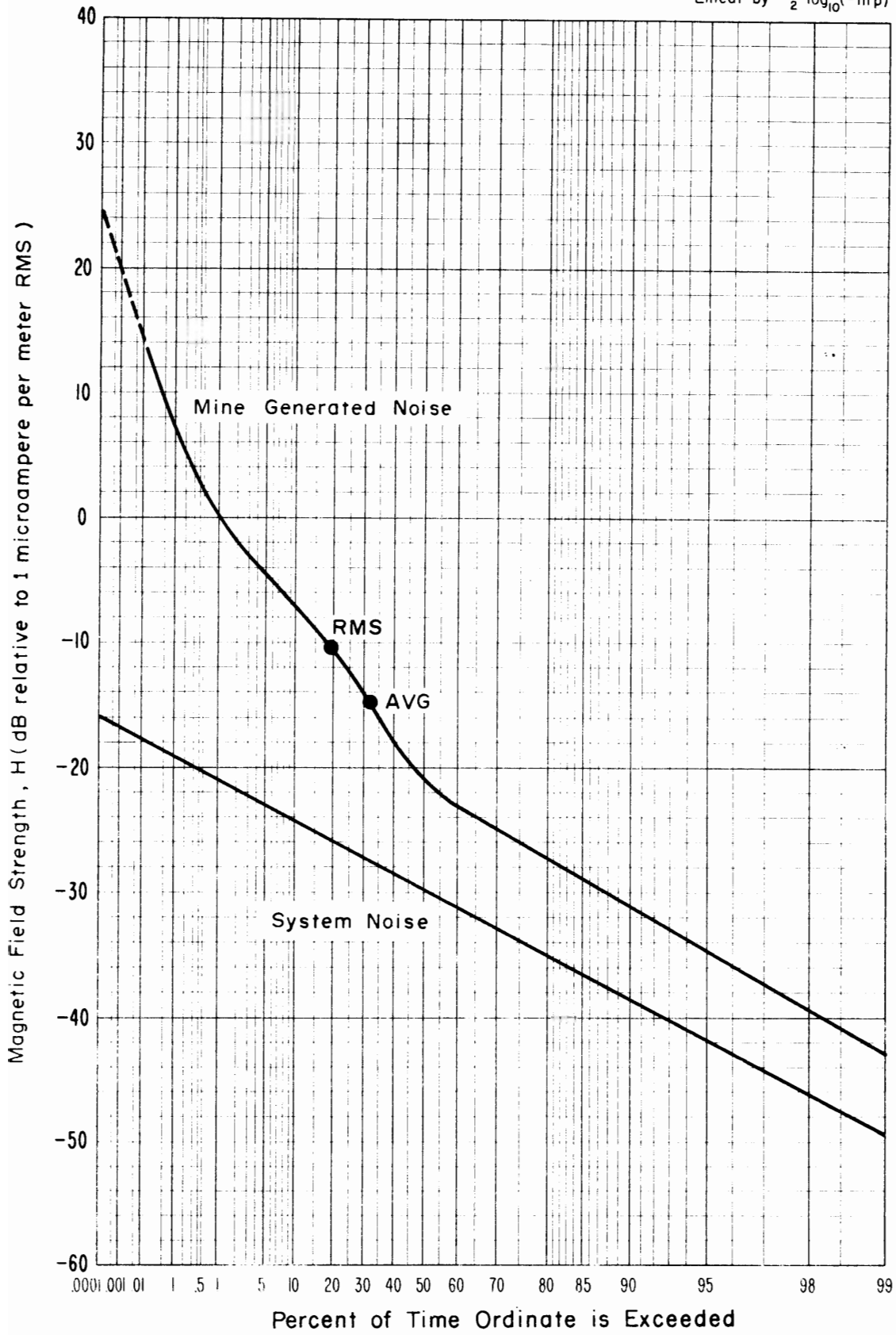

Figure 4-5 APD, Magnetic field strength, 30 kHz, Vertical component, Headframe, Lucky Friday Mine, 1 kHz predetection bandwidth. Time was 10:30 a.m., August 27, 1973.

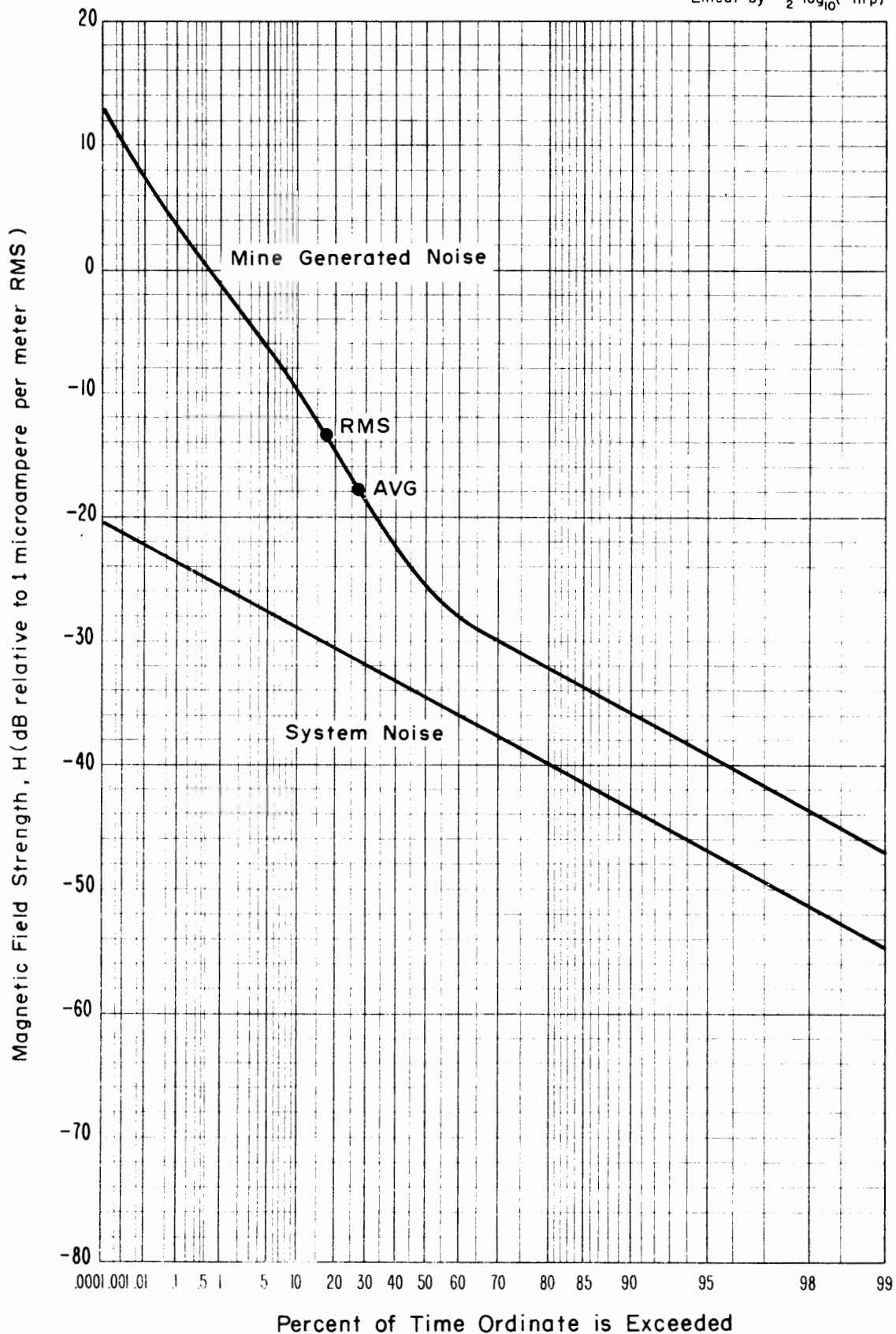

Figure 4-6 APD, Magnetic field strength, 70 kHz, Vertical component, Headframe, Lucky Friday Mine, 1 kHz predetection bandwidth. Time was 10:30 a.m., August 27, 1973.

Linear by $-\frac{1}{2} \log_{10}(-\ln p)$

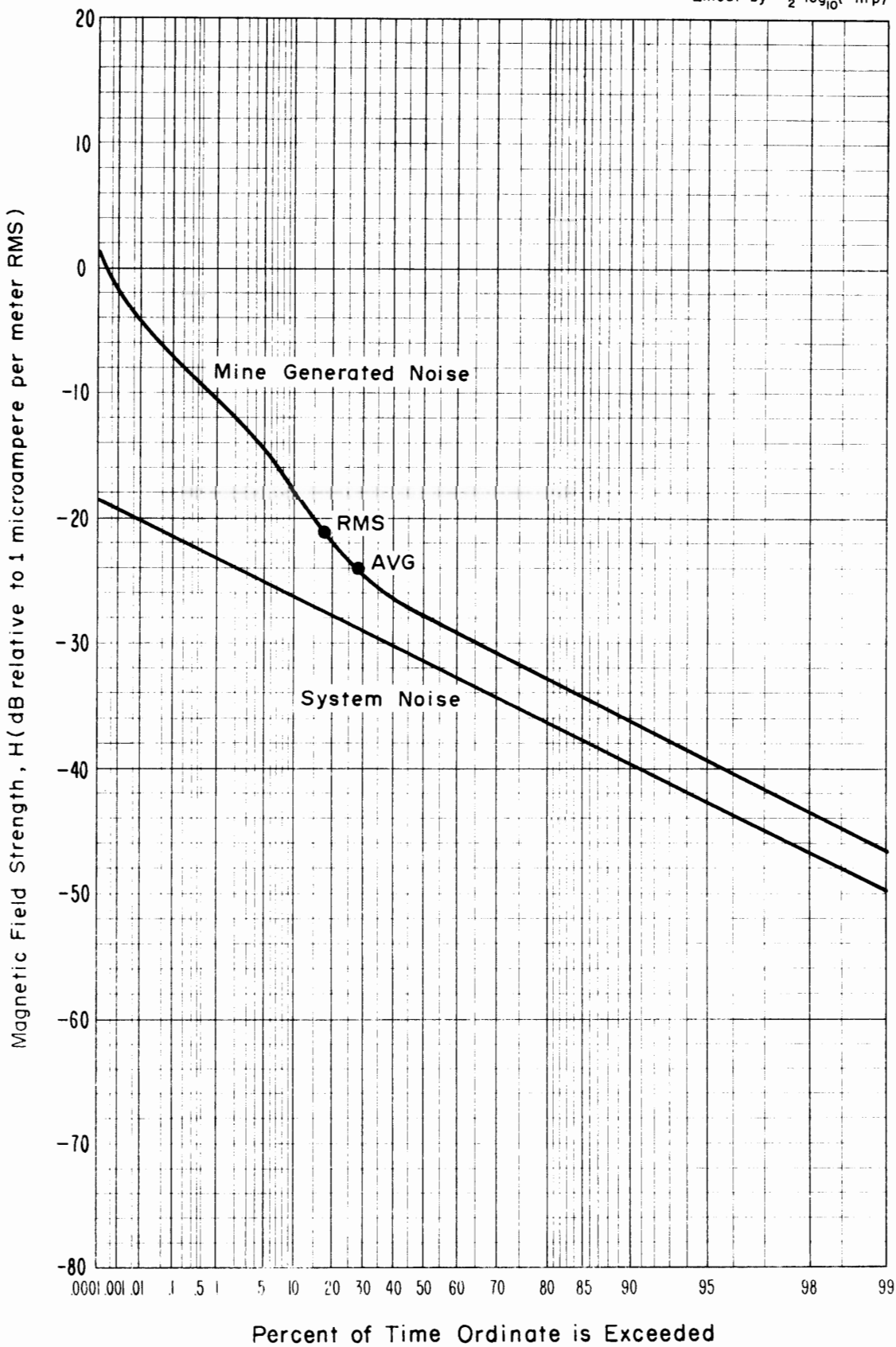

Figure 4-7 APD, Magnetic field strength, 150 kHz, Vertical component, Headframe, Lucky Friday Mine, 1.2 kHz predetection bandwidth. Time was 10:30 a.m., August 27, 1973.

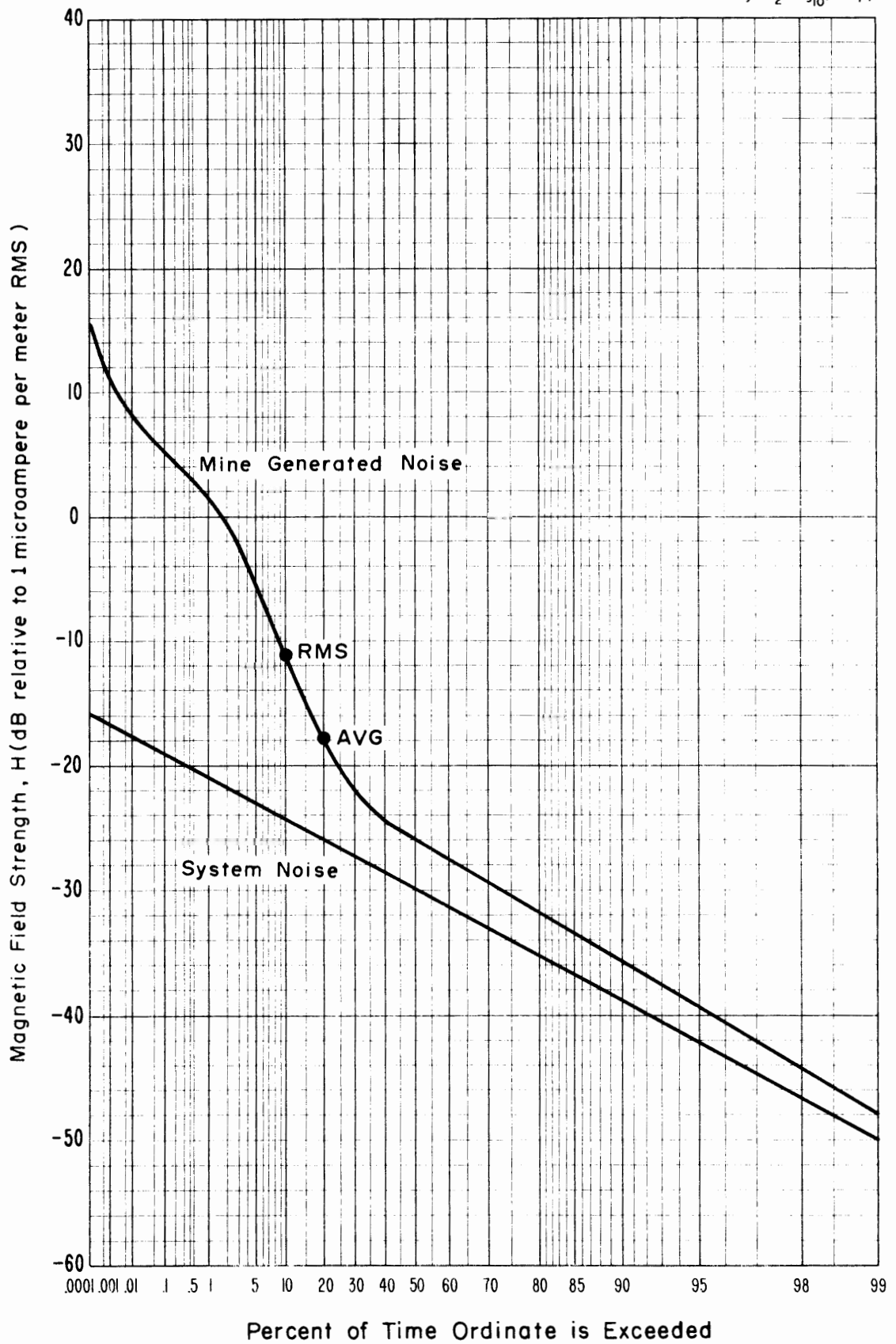

Figure 4-8 APD, Magnetic field strength, 250 kHz, Vertical component, Headframe, Lucky Friday Mine, 1.2 kHz predetection bandwidth. Time was 10:30 a.m., August 27, 1973.

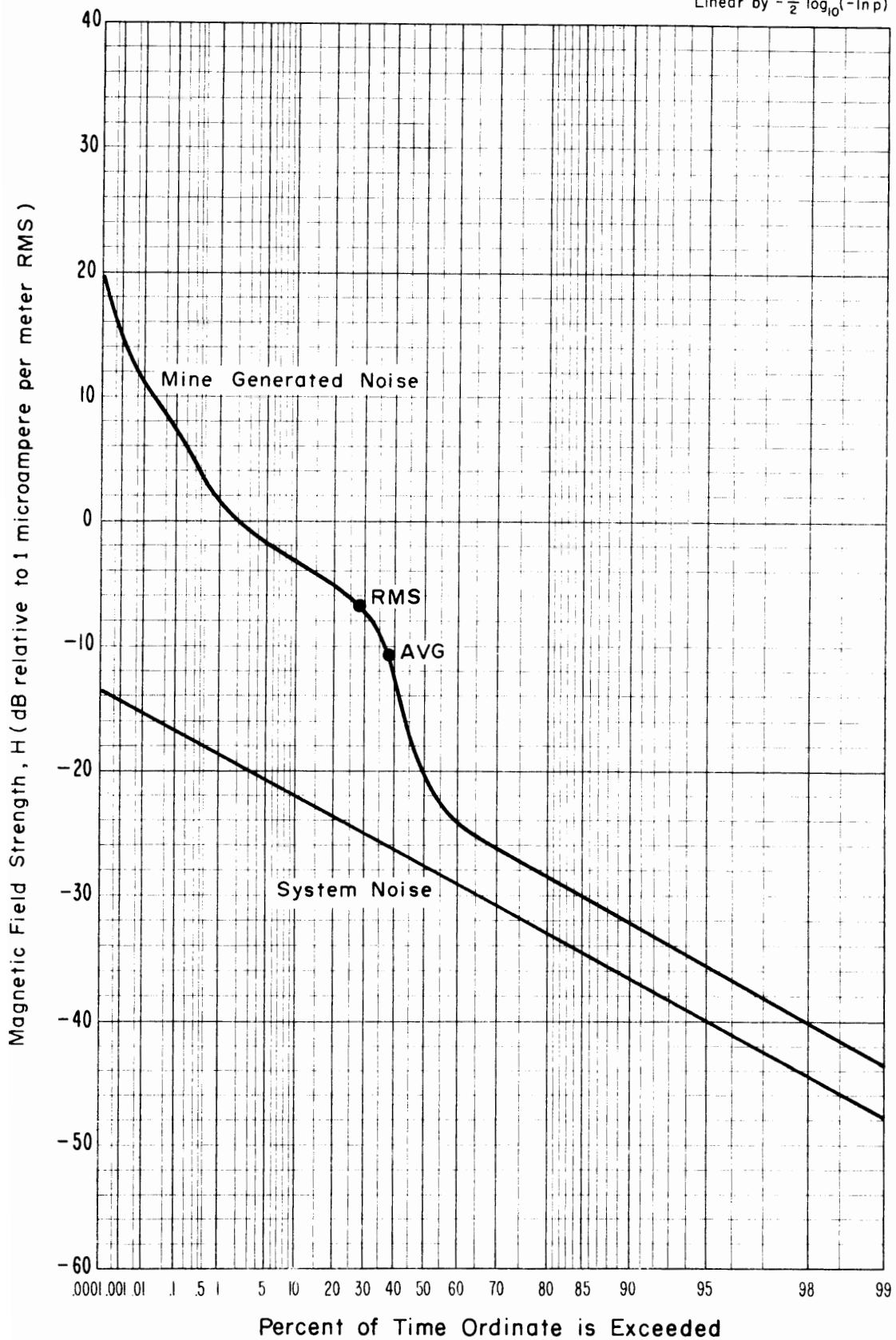

Figure 4-9 APD, Magnetic field strength, 30 kHz, Vertical component, 1450 level, Lucky Friday Mine, 1 kHz predetection bandwidth. Time was 1:00 p.m., August 27, 1973.

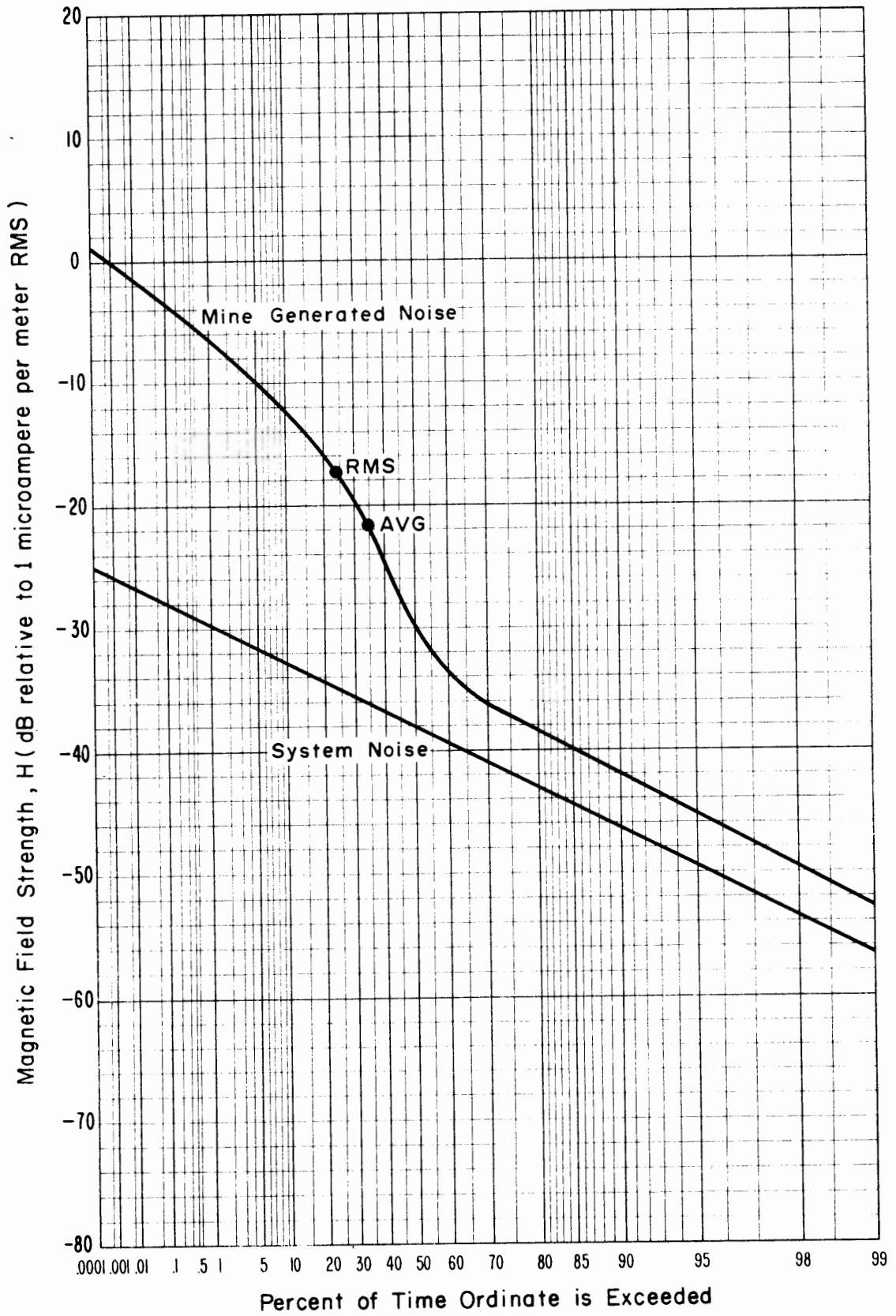

Figure 4-10 APD, Magnetic field strength, 70 kHz, Vertical component, 1450 level, Lucky Friday Mine, 1 kHz predetection bandwidth. Time was 1:00 p.m., August 27, 1973.

Linear by $-\frac{1}{2} \log_{10}(-\ln p)$

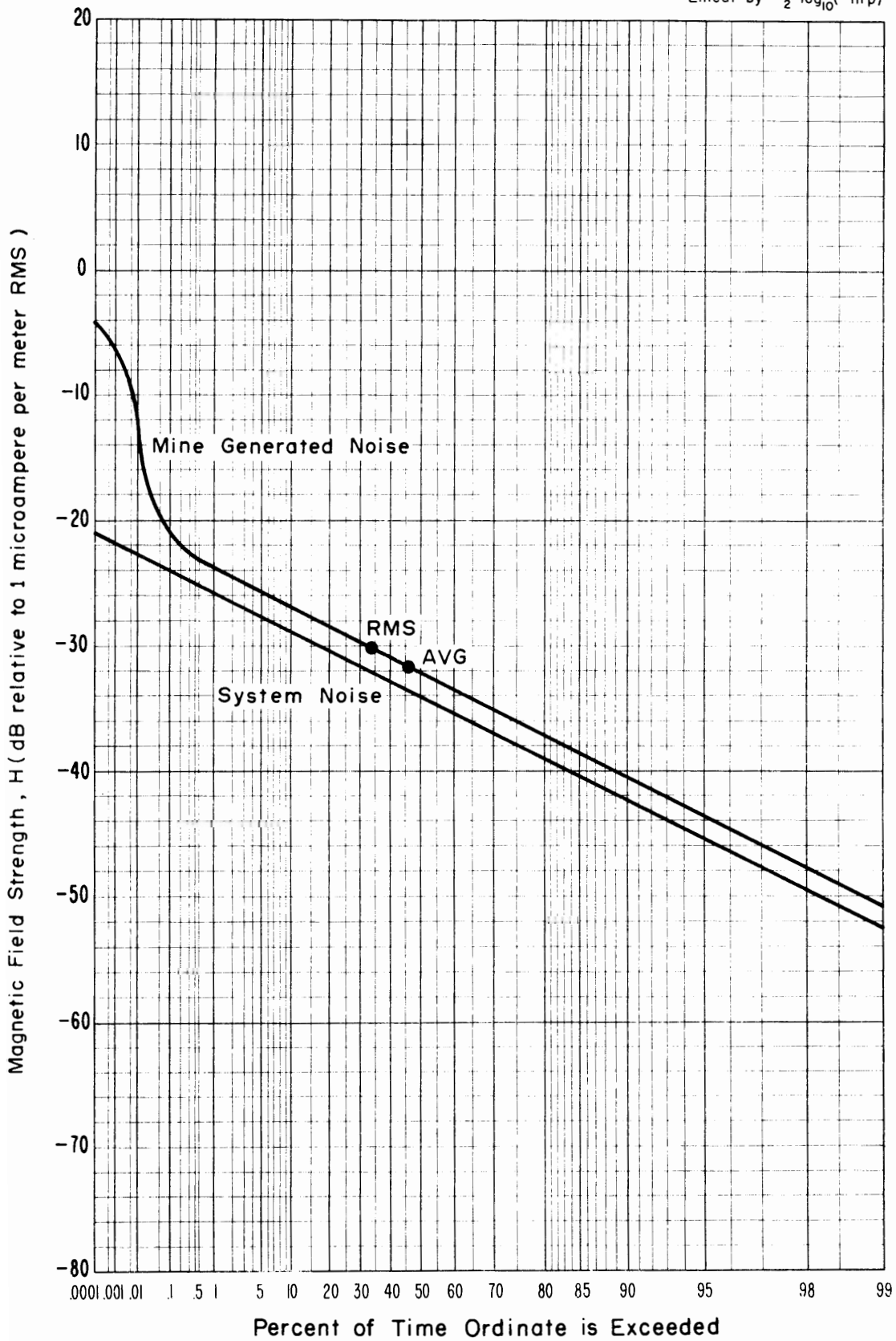

Figure 4-11 APD, Magnetic field strength, 150 kHz, Vertical component, 1450 level, Lucky Friday Mine, 1.2 kHz predetection bandwidth. Time was 1:00 p.m., August 27, 1973.

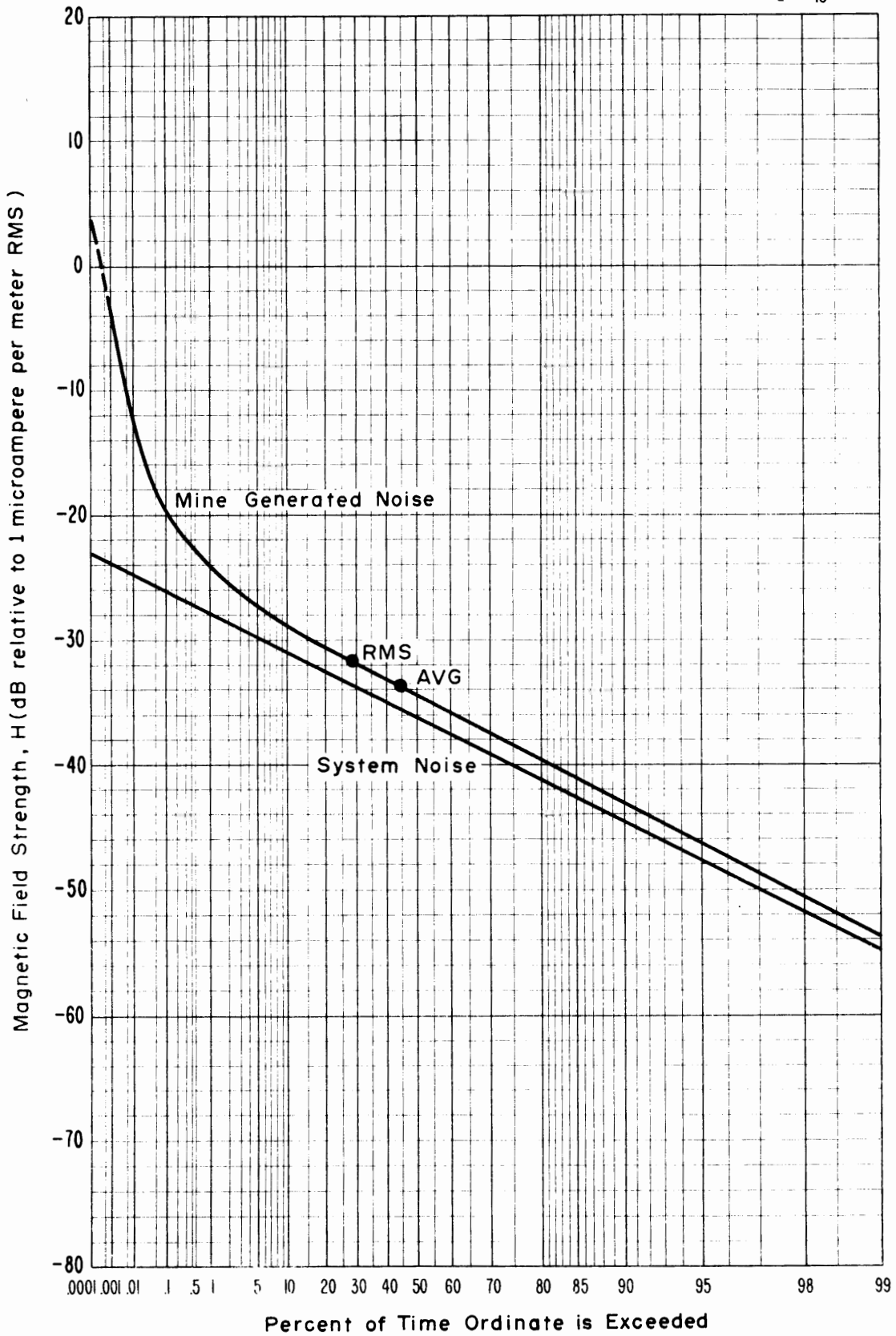

Figure 4-12 APD, Magnetic field strength, 250 kHz, Vertical component, 1450 level, Lucky Friday Mine, 1.2 kHz predetection bandwidth. Time was 1:00 p.m., August 27, 1973.

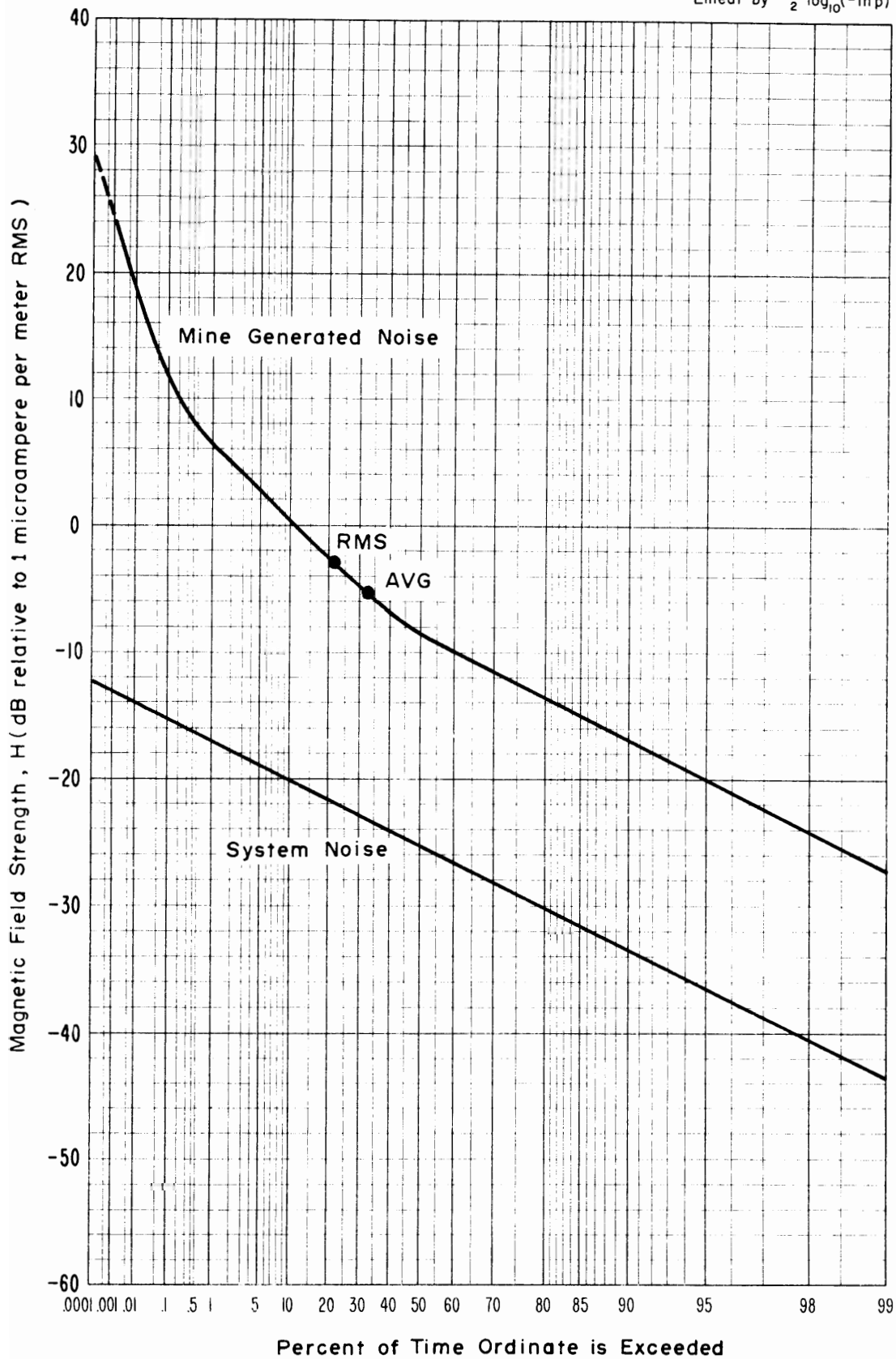

Figure 4-13 APD, Magnetic field strength, 30 kHz, Horizontal (North-South) component, 1450 level, Lucky Friday Mine, 1 kHz predetection bandwidth. Time was 1:30 p.m., August 27, 1973.

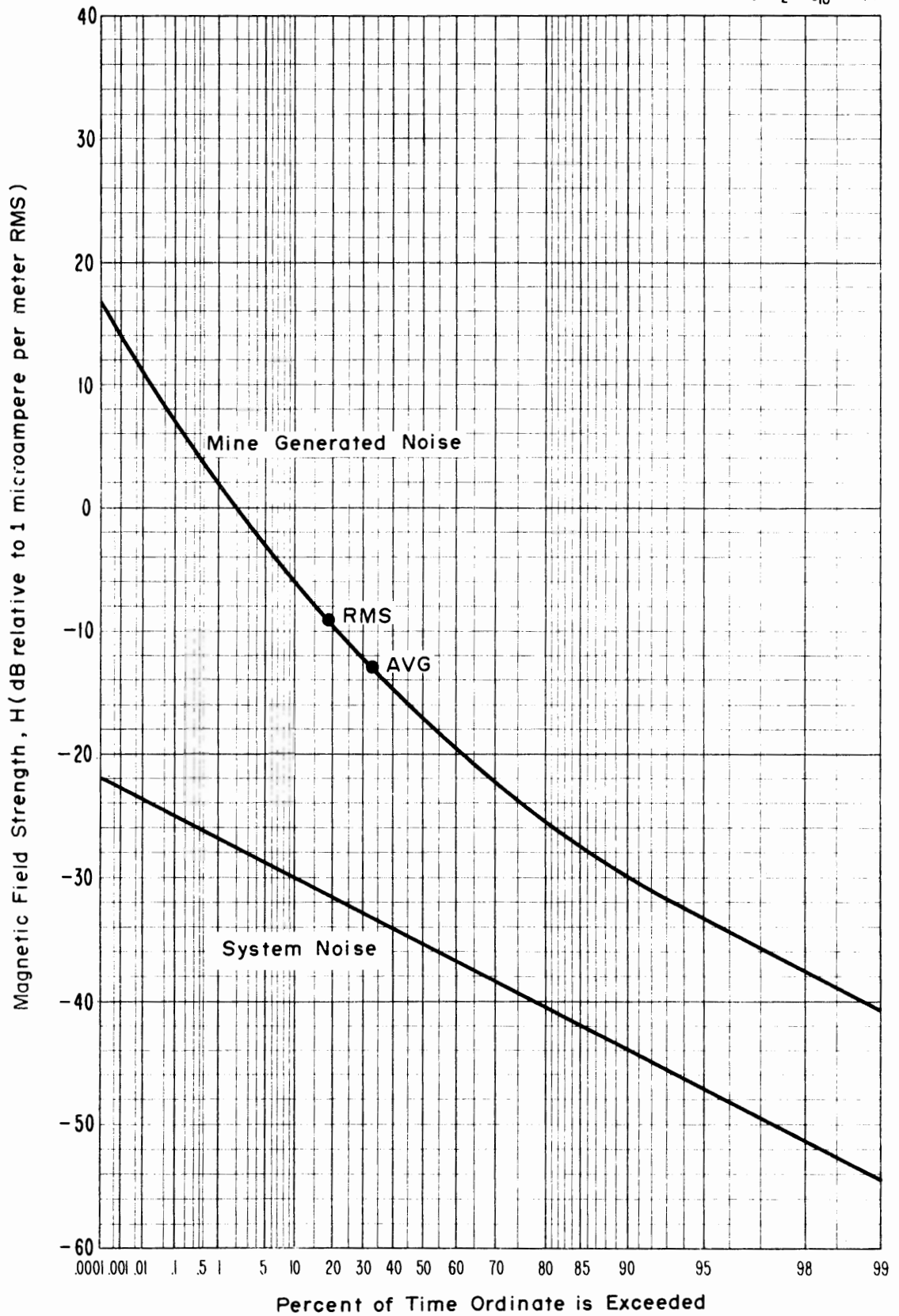

Figure 4-14 APD, Magnetic field strength, 70 kHz, Horizontal (North-South) component, 1450 level, Lucky Friday Mine, 1 kHz predetection bandwidth. Time was 1:30 p.m., August 27, 1974.

Linear by $-\frac{1}{2} \log_{10}(-\ln p)$

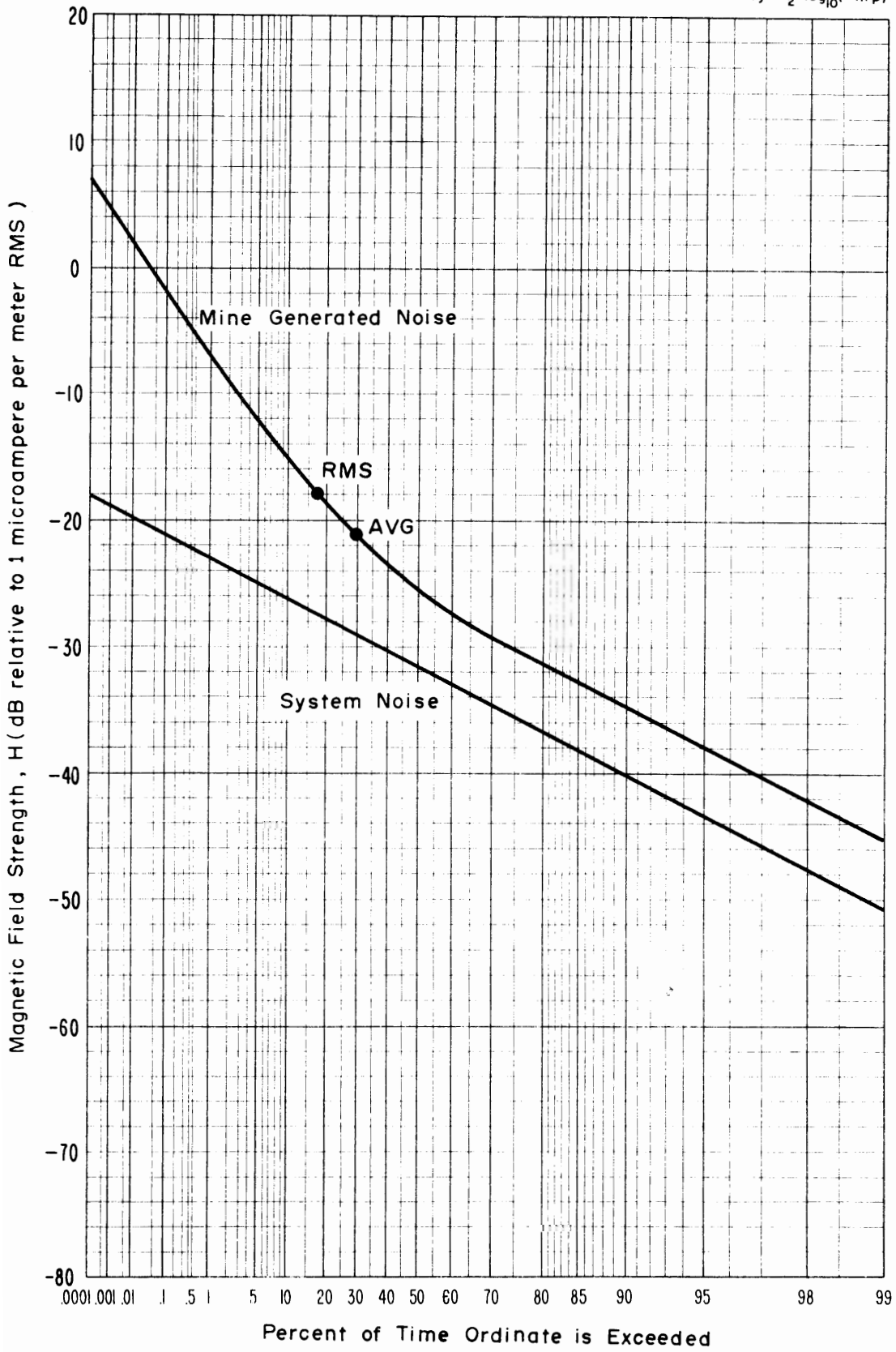

Figure 4-15 APD, Magnetic field strength, 150 kHz, Horizontal (North-South) component, 1450 level, Lucky Friday Mine, 1.2 kHz predetection bandwidth. Time was 1:30 p.m., August 27, 1973.

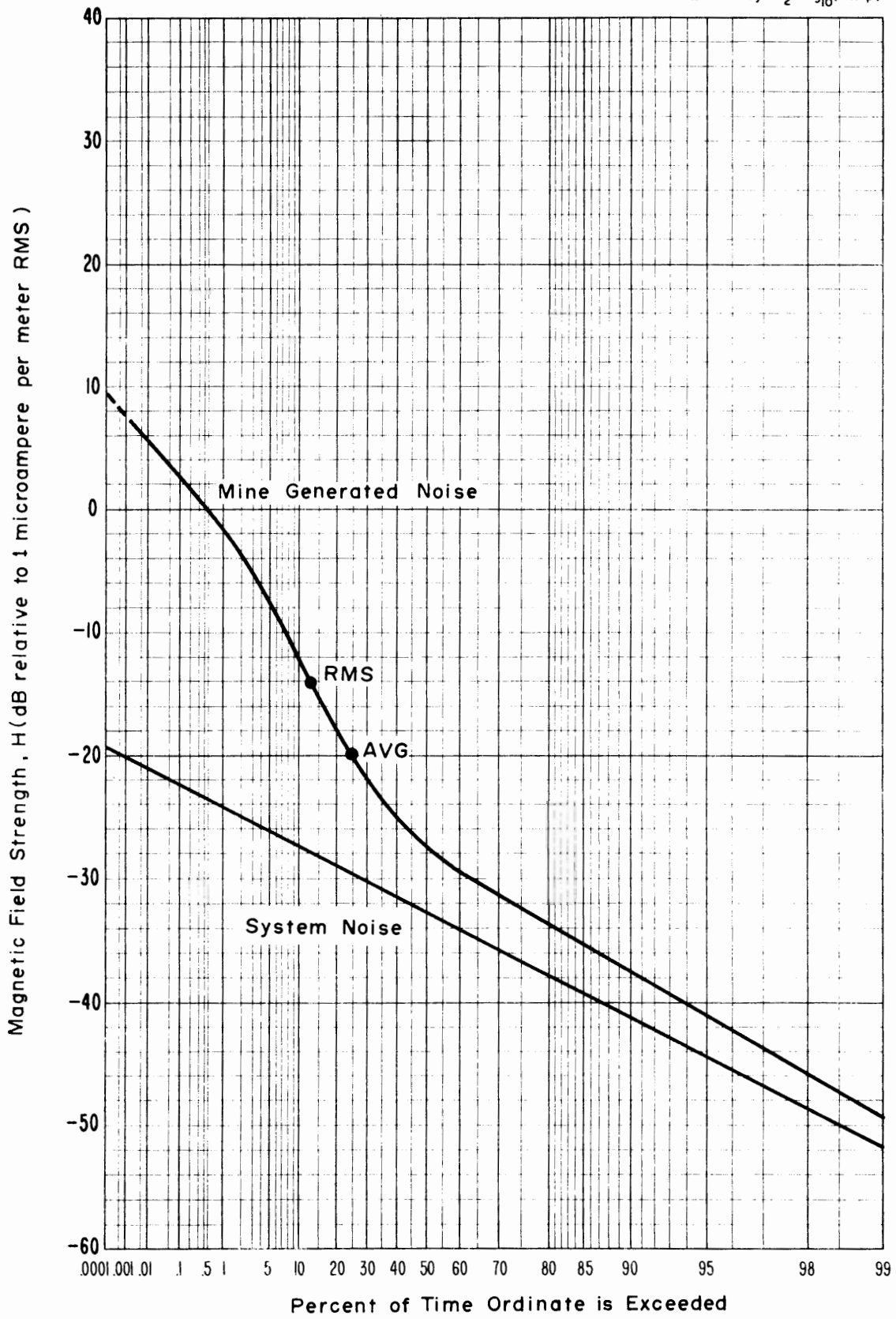

Figure 4-16 APD, Magnetic field strength, 250 kHz, Horizontal (North-South) component, 1450 level, Lucky Friday Mine, 1.2 kHz predetection bandwidth. Time was 1:30 p.m., August 27, 1973.

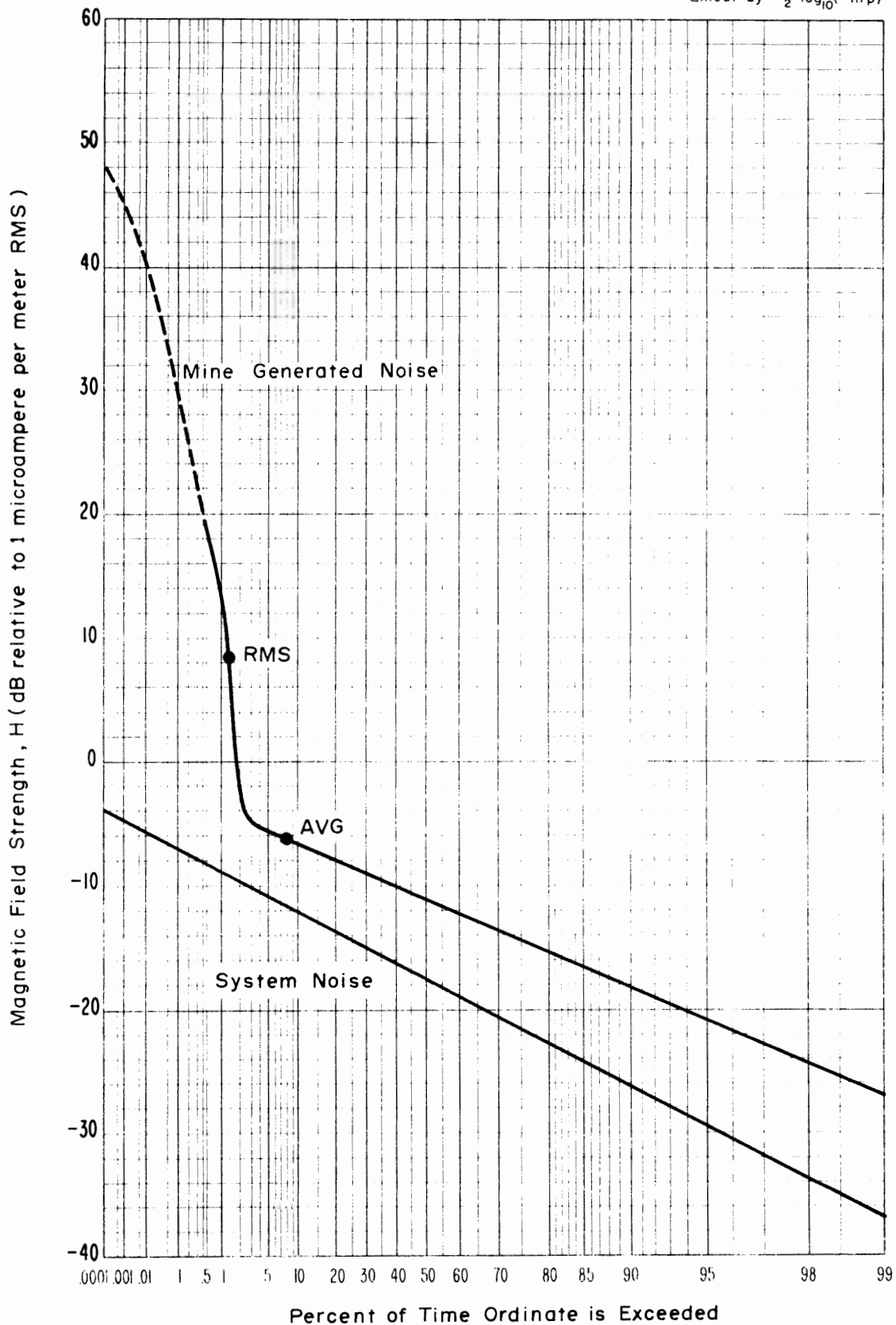

Figure 4-17 APD, Magnetic field strength, 30 kHz, Horizontal (North-South) component, 3050 level, Lucky Friday Mine, 1 kHz predetection bandwidth. Time was 3:00 p.m., August 27, 1973.

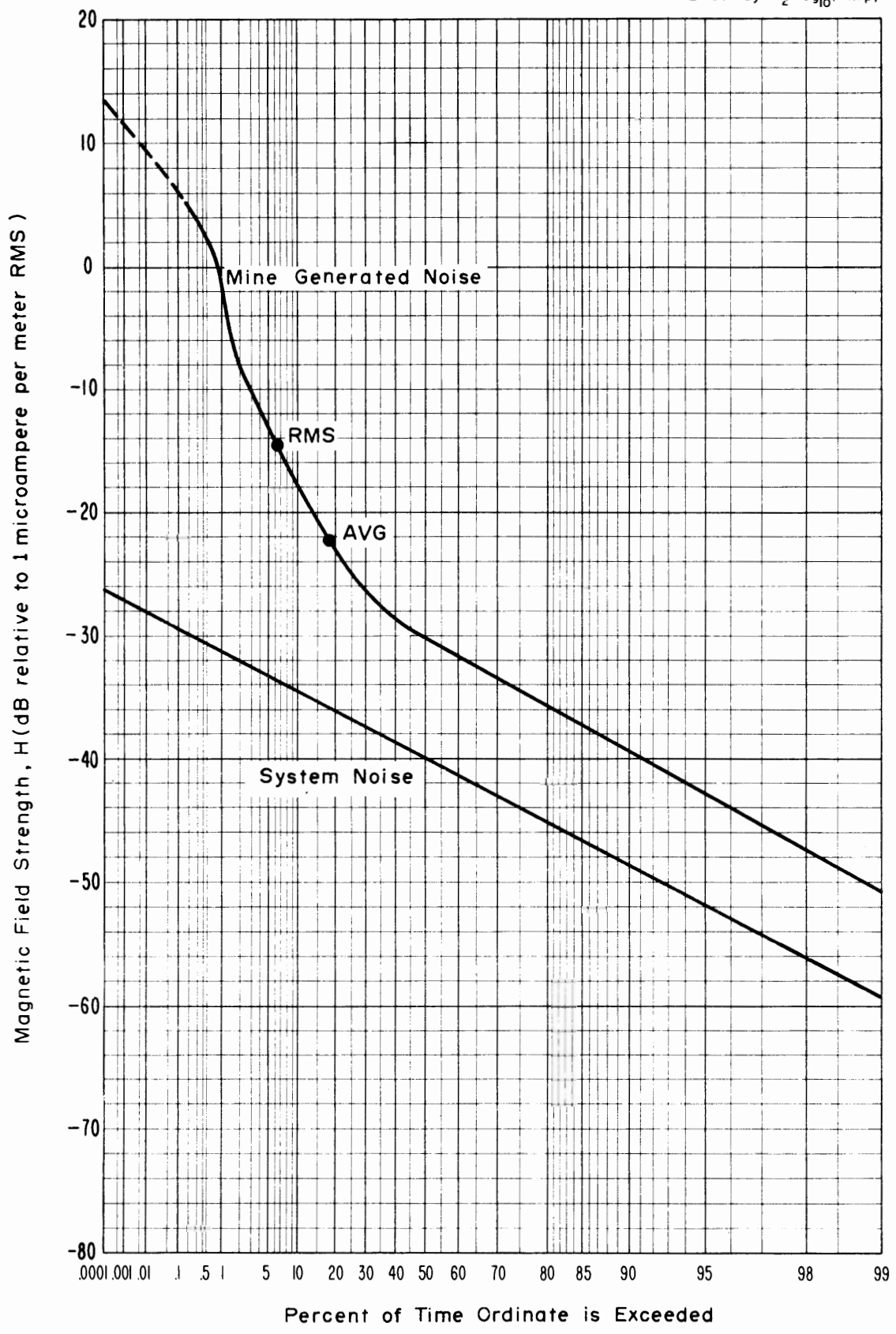

Figure 4-18 APD, Magnetic field strength, 70 kHz, Horizontal (North-South) component, 3050 level, Lucky Friday Mine, 1 kHz predetection bandwidth. Time was 3:00 p.m., August 27, 1973.

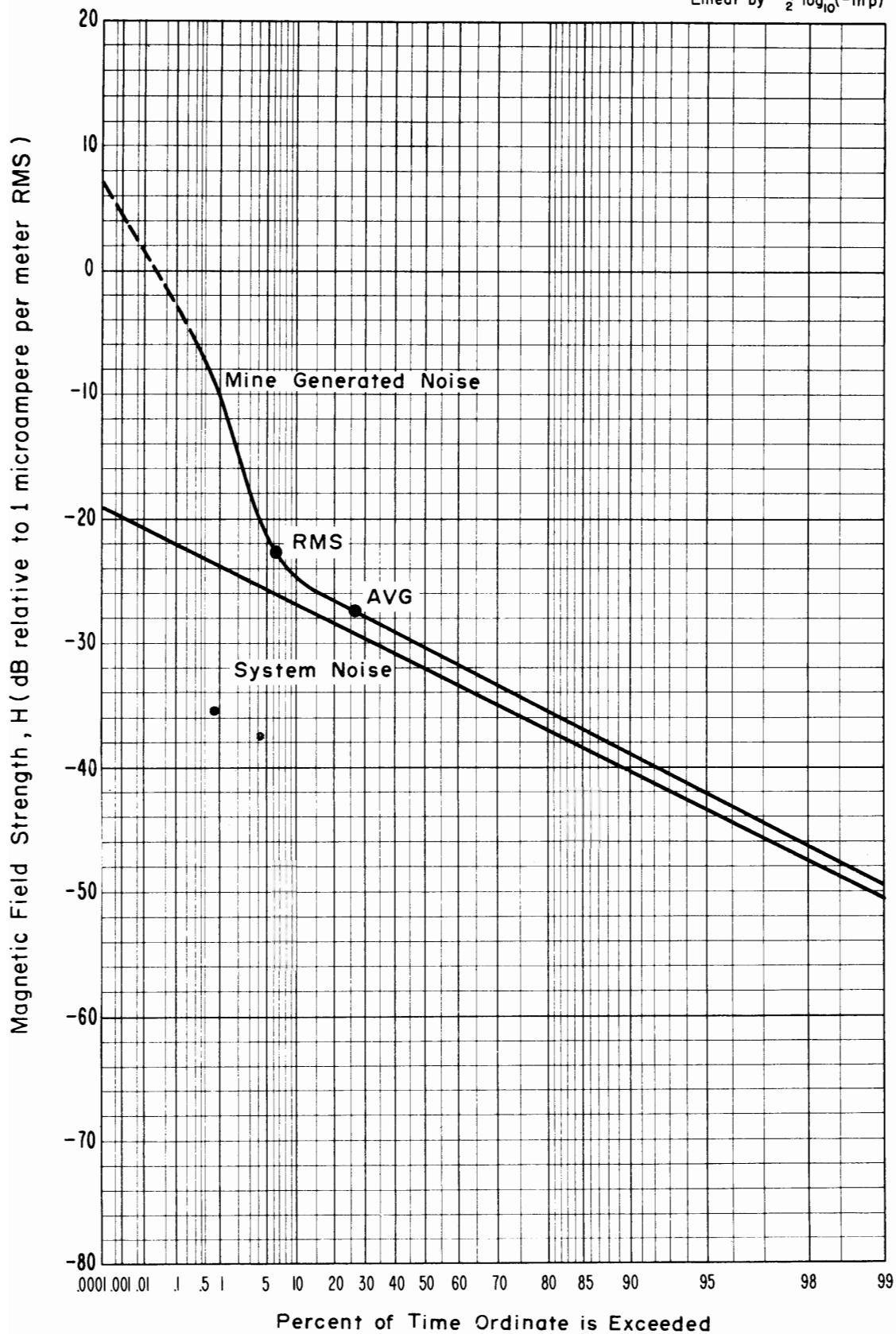

Figure 4-19 APD, Magnetic field strength, 150 kHz, Horizontal (North-South) component, 3050 level, Lucky Friday Mine, 1.2 kHz predetection bandwidth. Time was 3:00 p.m., August 27, 1973.

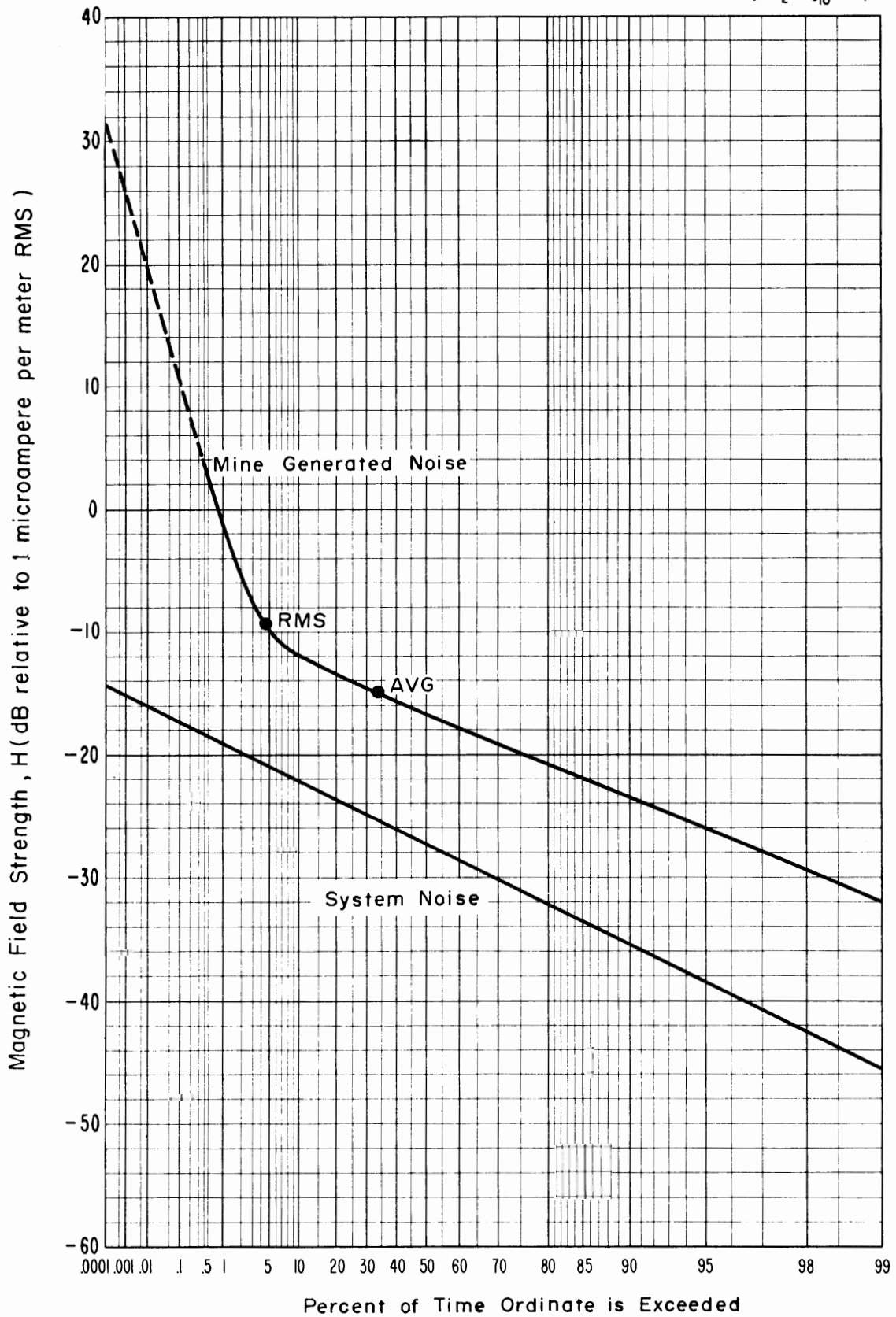

Figure 4-20 APD, Magnetic field strength, 30 kHz, Vertical component, 3050 level, Lucky Friday Mine, 1 kHz predetection bandwidth. Time was 2:30 p.m., August 27, 1973.

Linear by $-\frac{1}{2} \log_{10}(-\ln p)$

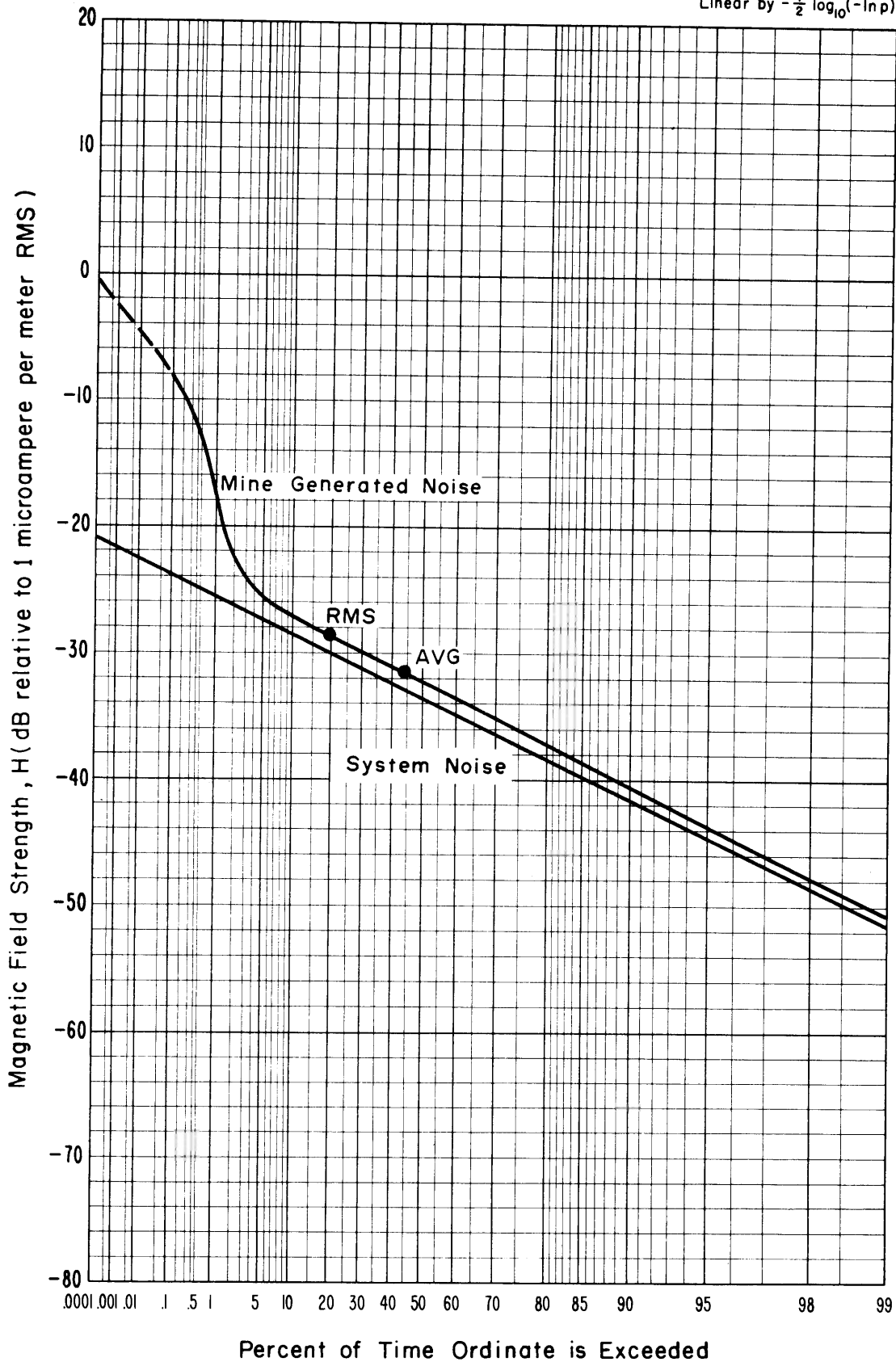

Figure 4-21 APD, Magnetic field strength, 70 kHz, Vertical component, 3050 level, Lucky Friday Mine, 1 kHz predetection bandwidth. Time was 2:30 p.m., August 27, 1973.

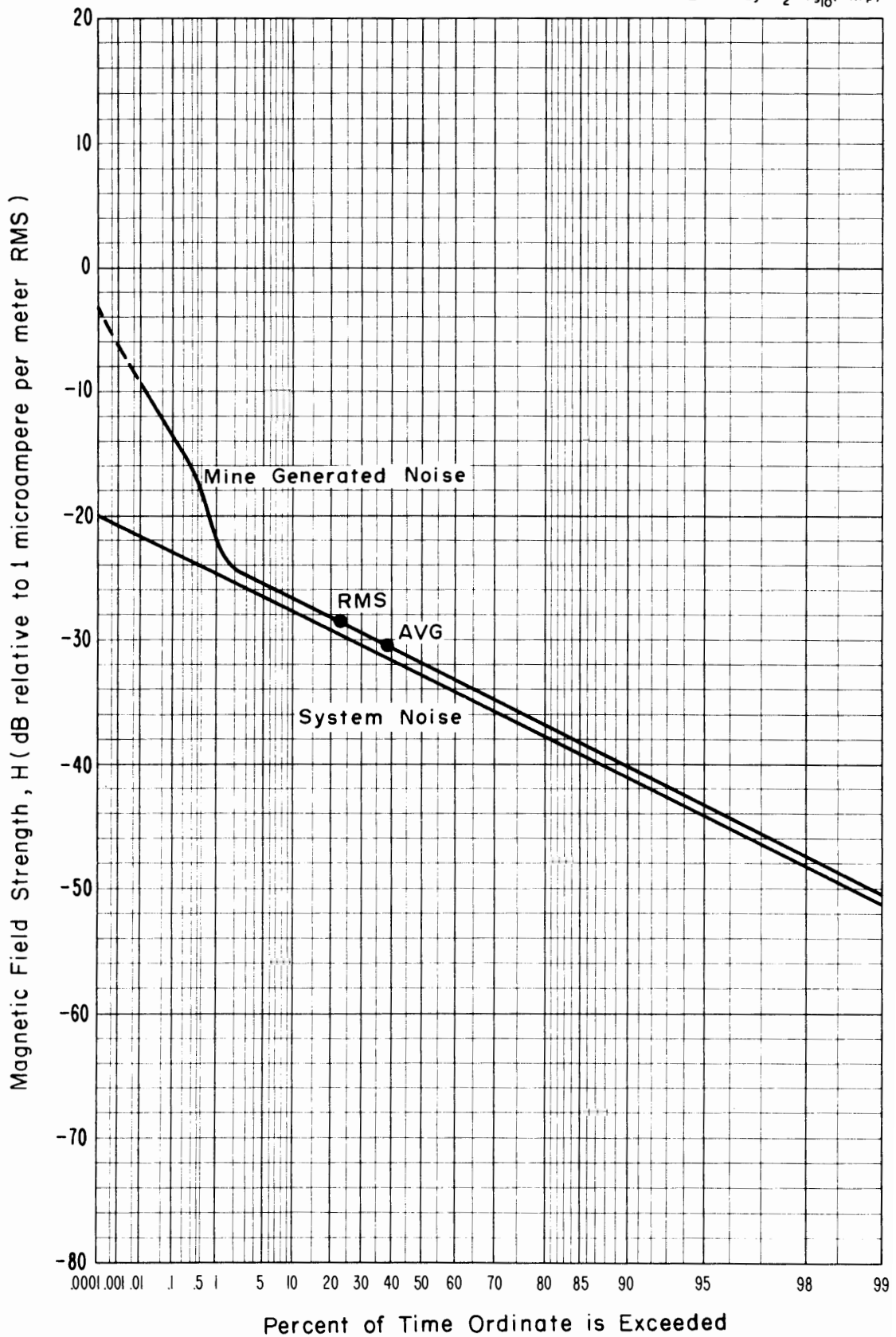

Figure 4-22 APD, Magnetic field strength, 150 kHz, Vertical component, 3050 level, Lucky Friday Mine, 1.2 kHz pre-detection bandwidth. Time was 2:30 p.m., August 27, 1973.

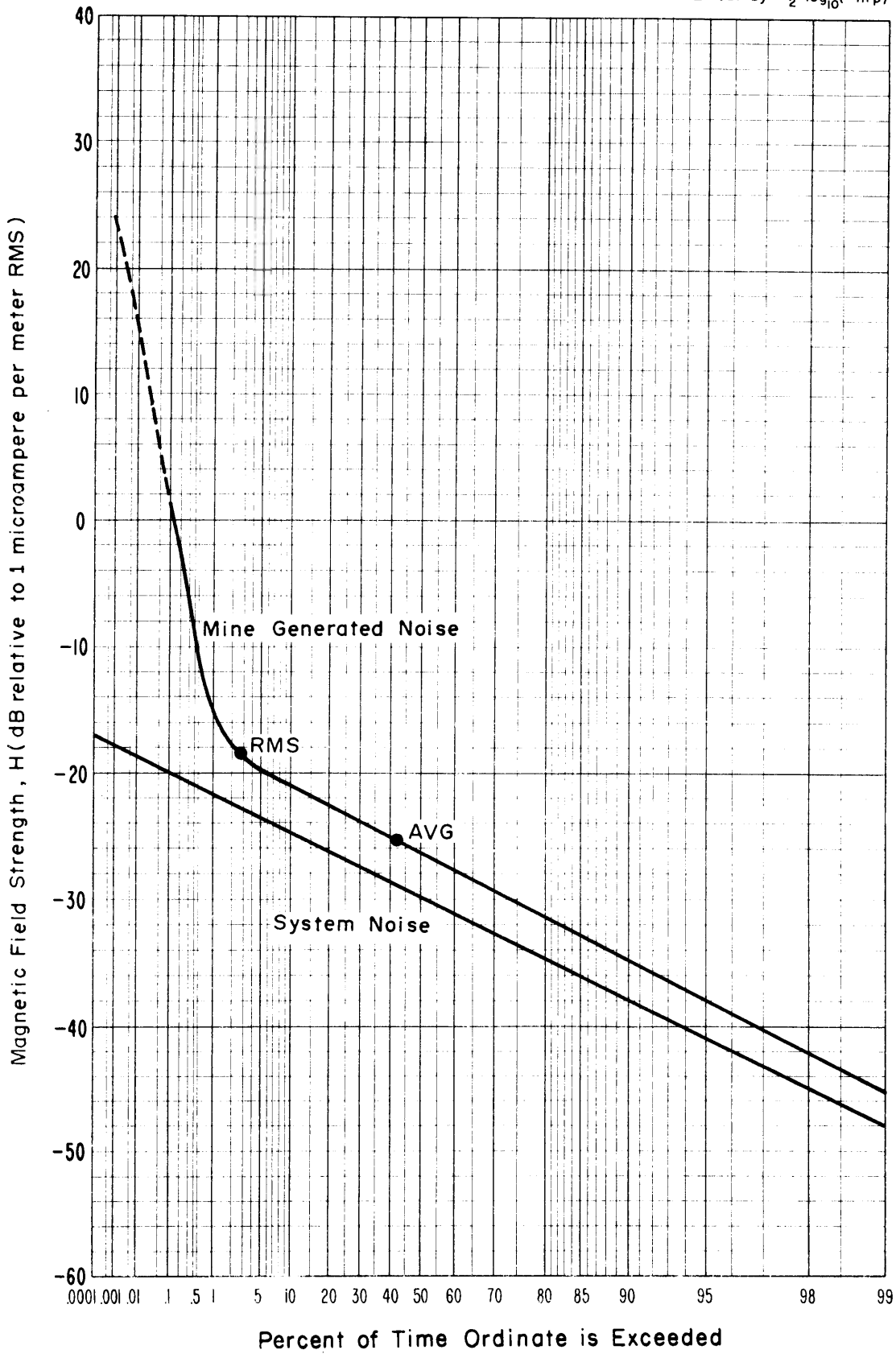

Figure 4-23 APD, Magnetic field strength, 35 kHz, Horizontal (North-South) component, 3650 level, Lucky Friday Mine, 1 kHz predetection bandwidth. Time was 10:00 a.m., February 8, 1974.

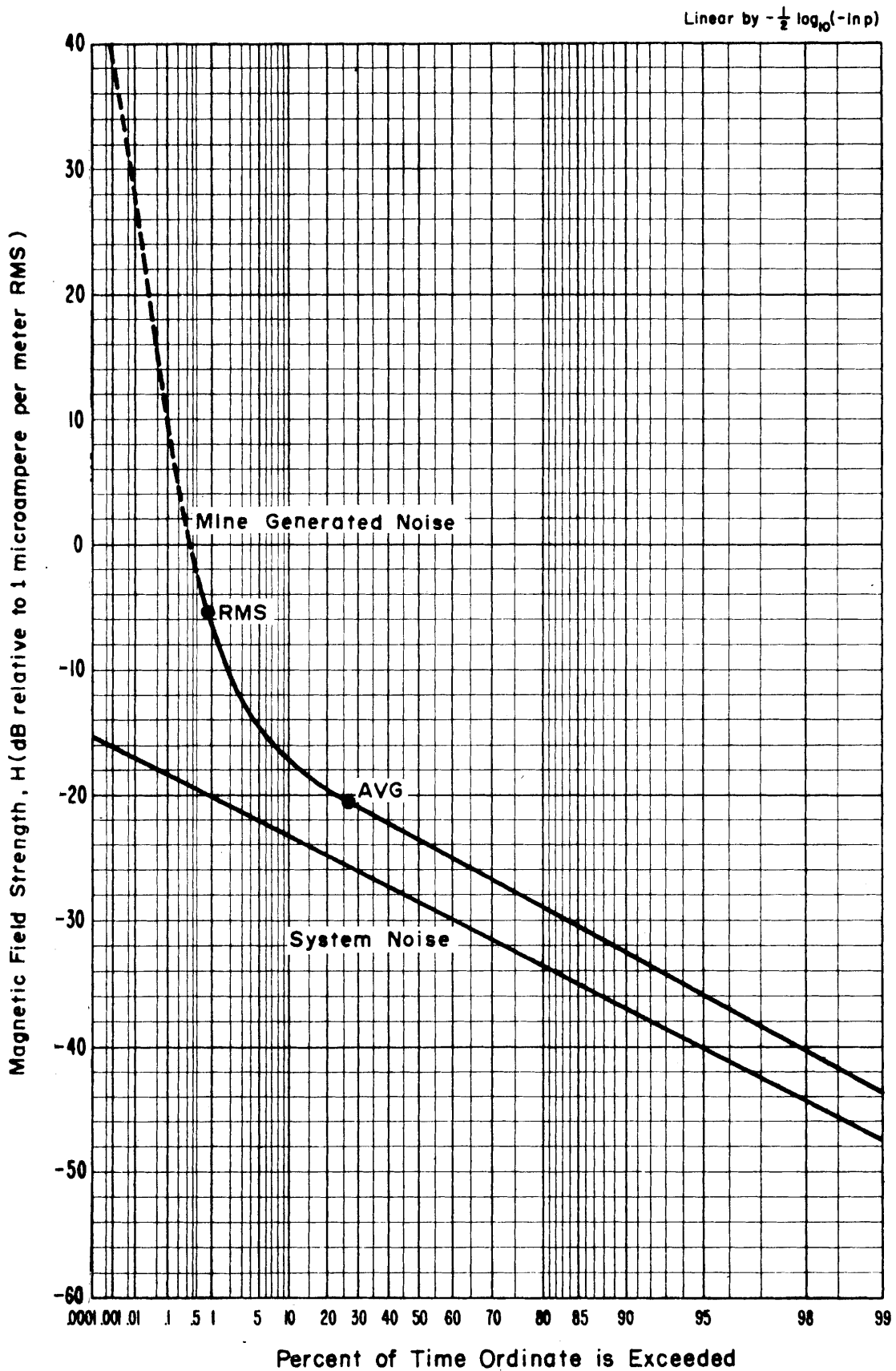

Figure 4-24 APD, Magnetic field strength, 75 kHz, Horizontal (North-South) component, 3650 level, Lucky Friday Mine, 1 kHz predetection bandwidth. Time was 10:00 a.m., February 8, 1974.

Linear by $-\frac{1}{2} \log_{10}(-\ln p)$

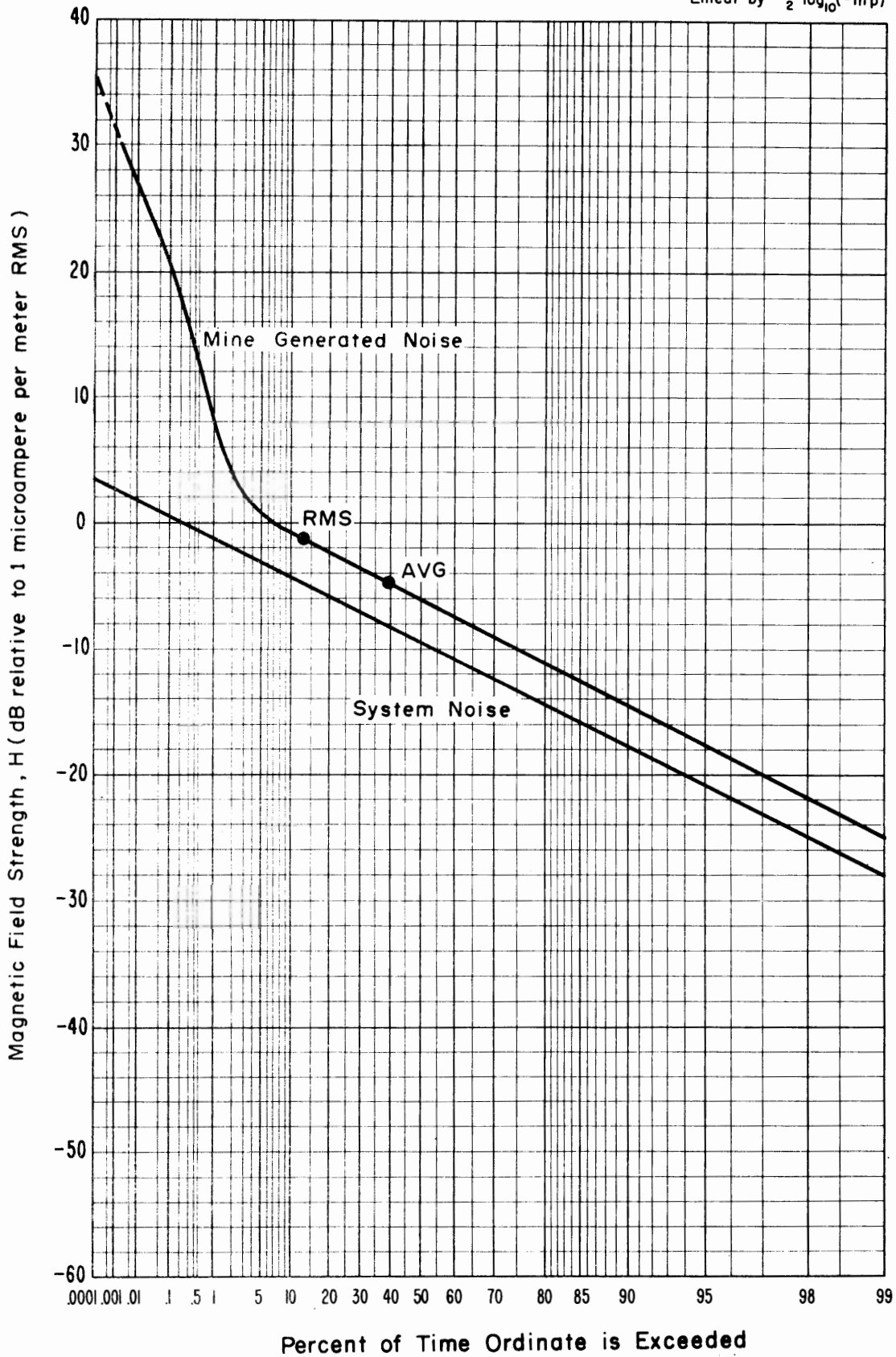

Figure 4-25 APD, Magnetic field strength, 200 kHz, Horizontal (North-South) component, 3650 level, Lucky Friday Mine, 1.2 kHz predetection bandwidth. Time was 10:00 a.m., February 8, 1974.

Linear by $-\frac{1}{2} \log_{10}(-\ln p)$

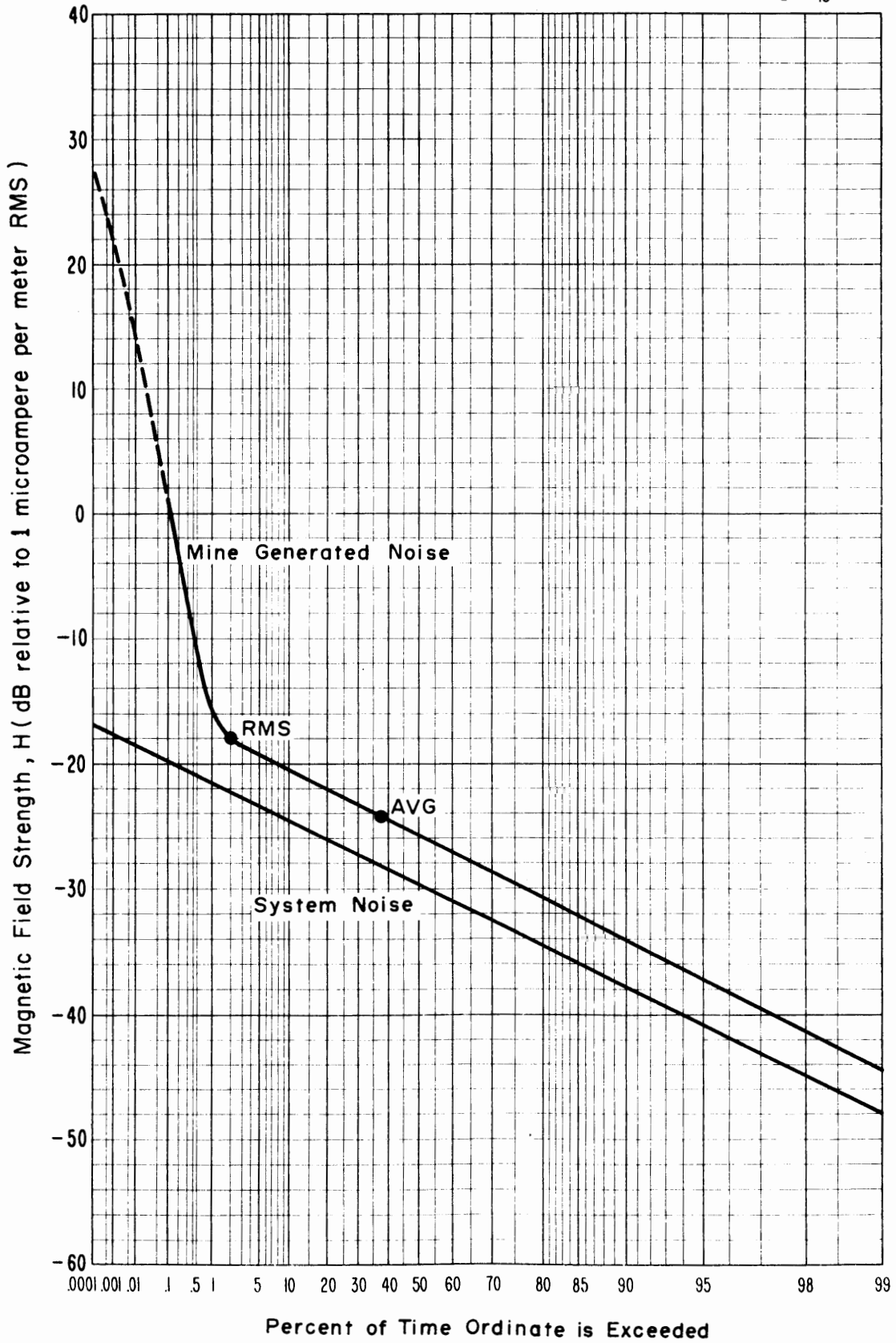

Figure 4-26 APD, Magnetic field strength, 35 kHz, Vertical component, 3650 level, Lucky Friday Mine, 1 kHz predetection bandwidth. Time was 10:30 a.m., February 8, 1974.

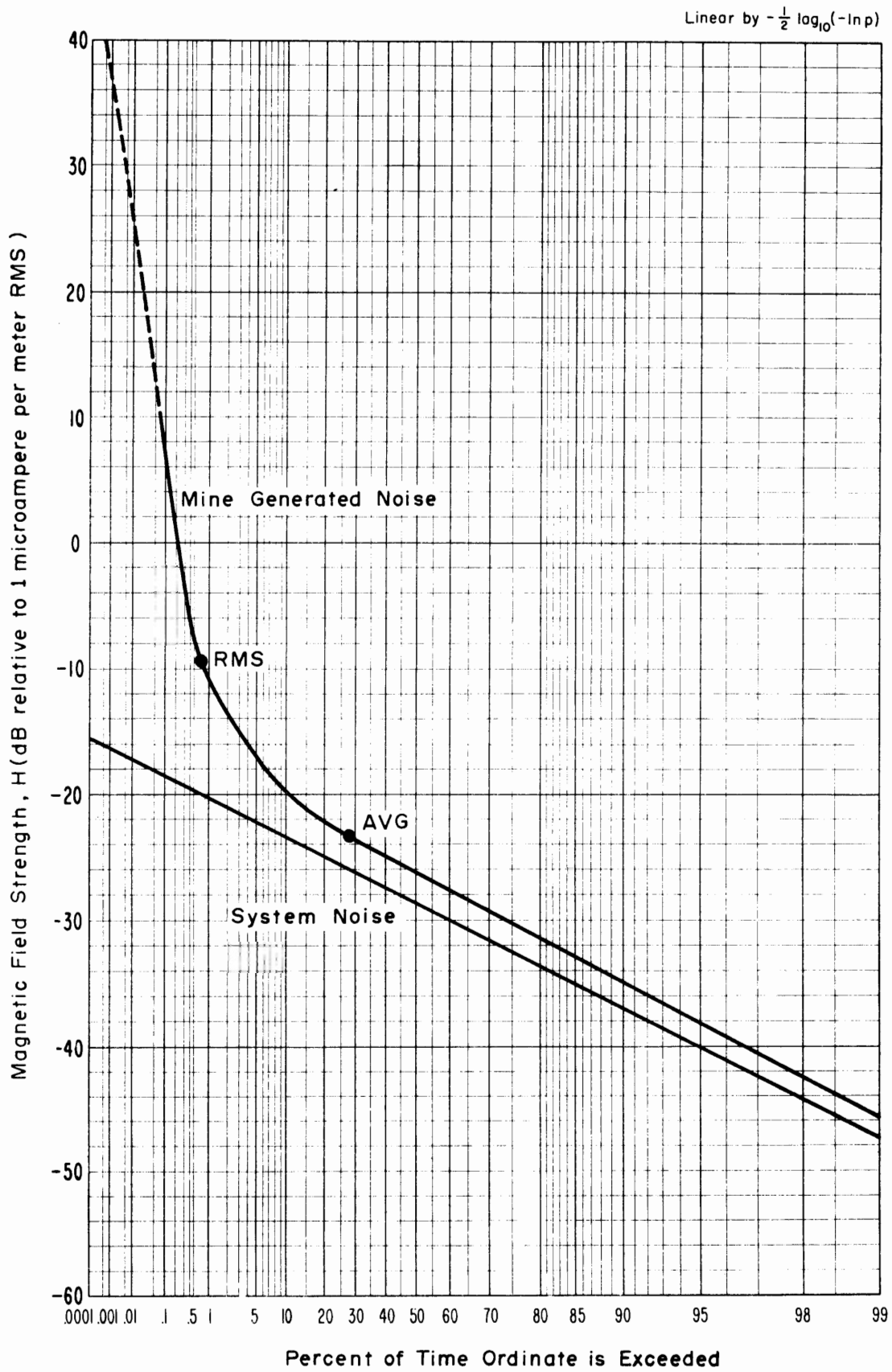

Figure 4-27 APD, Magnetic field strength, 75 kHz, Vertical component, 3650 level, Lucky Friday Mine, 1 kHz predetection bandwidth. Time was 10:30 a.m., February 8, 1974.

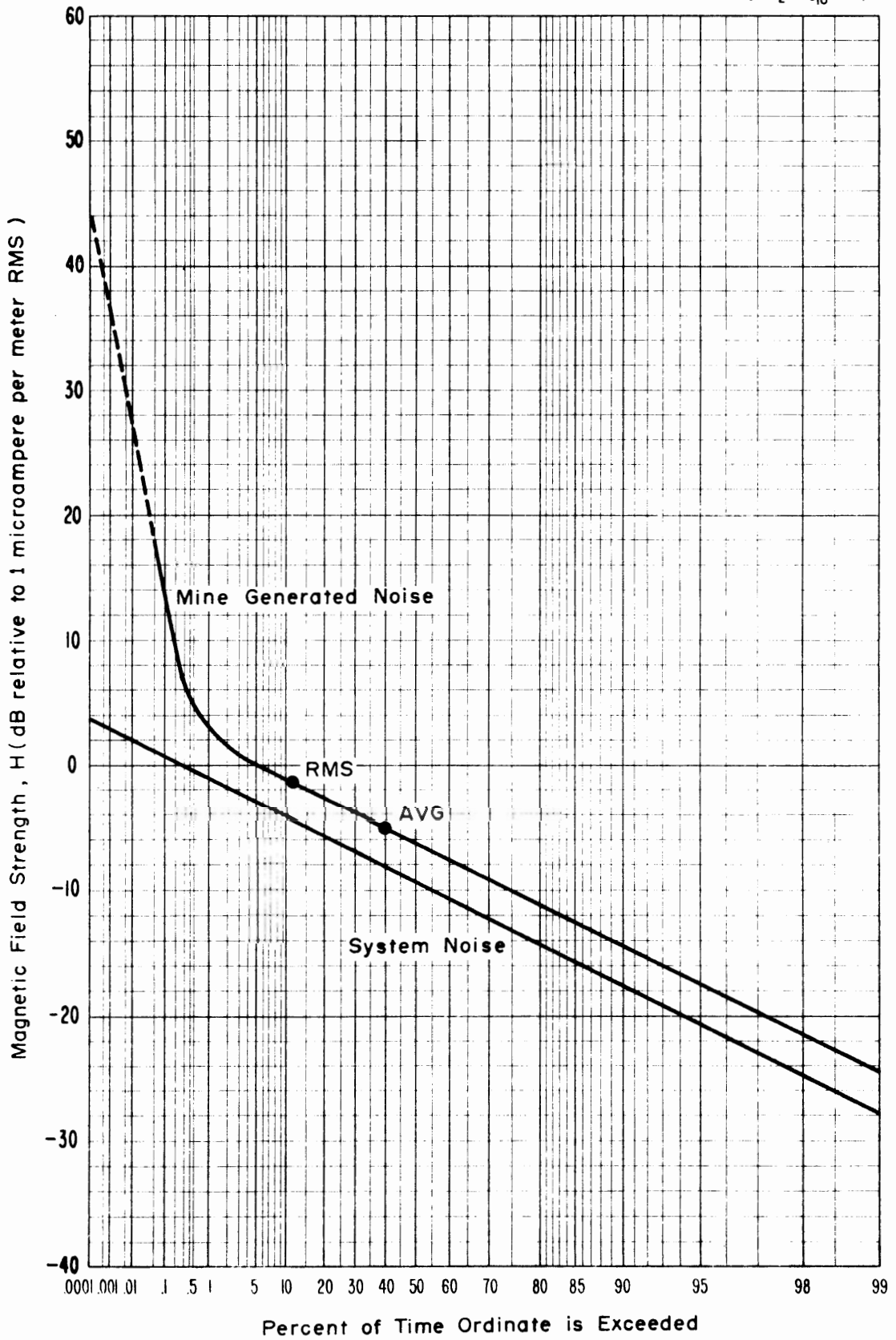

Figure 4-28 APD, Magnetic field strength, 200 kHz, Vertical component, 3650 level, Lucky Friday Mine, 1.2 kHz predetection bandwidth. Time was 10:30 a.m., February 8, 1974.

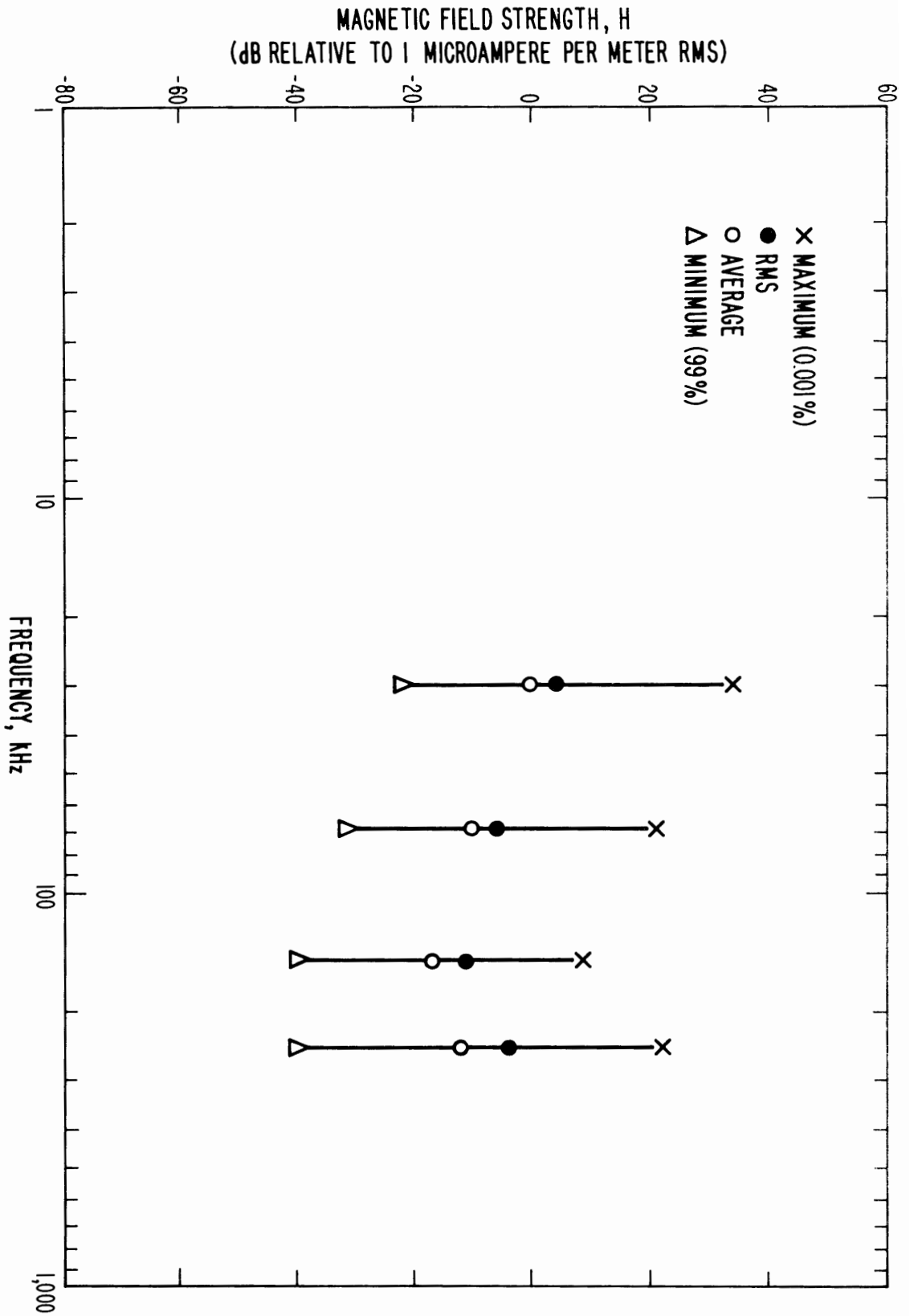

Figure 4-29 Summary curves of magnetic field strength excursions between 0.001% and 99% of the time as a function of frequency. Headframe, Lucky Friday Mine, Horizontal (North-South) component, August 27, 1973.

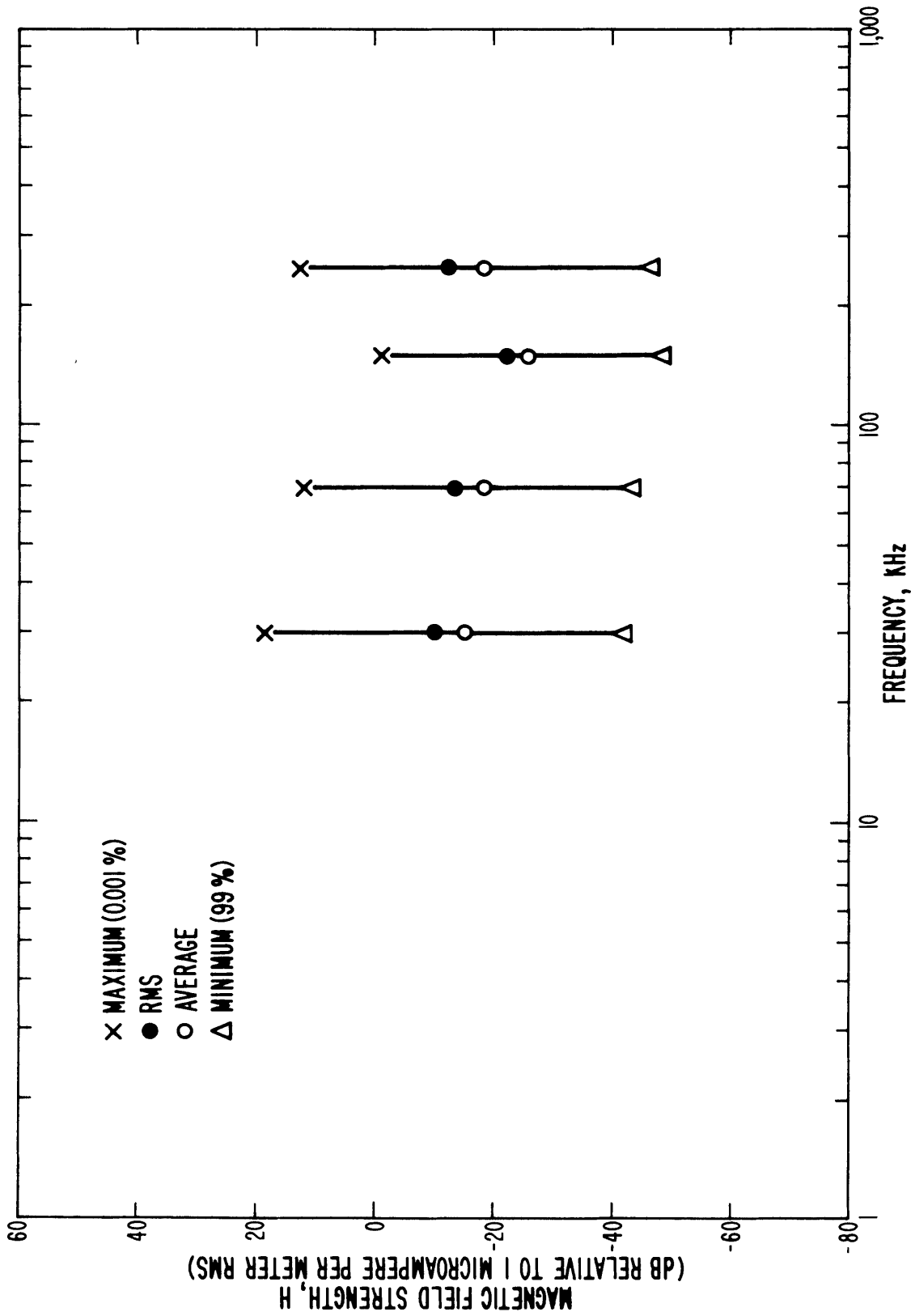

Figure 4-30 Summary curves of magnetic field strength excursions between 0.001% and 99% of the time as a function of frequency. Headframe, Lucky Friday Mine,, Vertical component, August 27, 1973

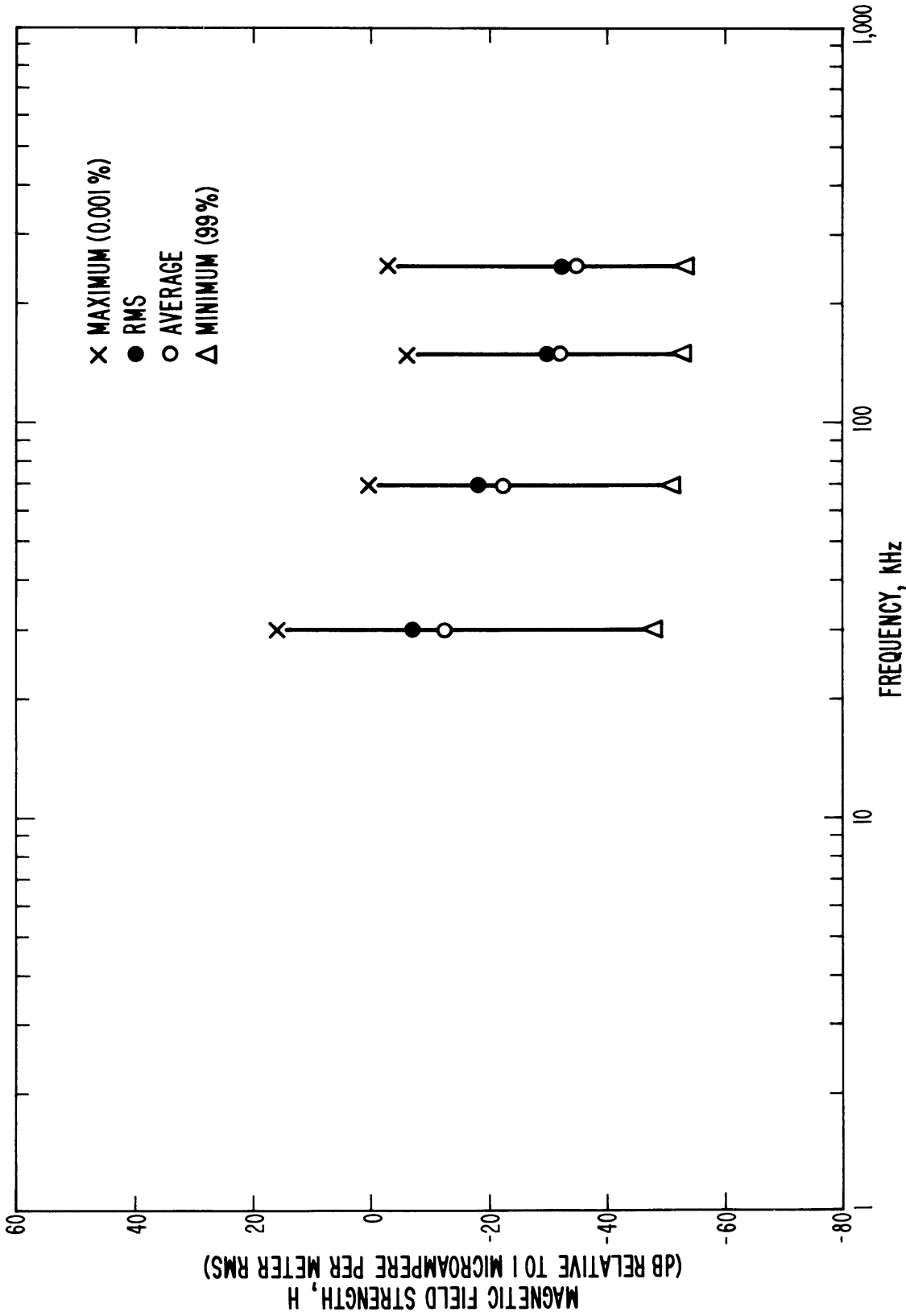

Figure 4-31 Summary curves of magnetic field strength excursions between 0.001% and 99% of the time as a function of frequency. 1450 level, Lucky Friday Mine, Vertical component, August 27, 1973.

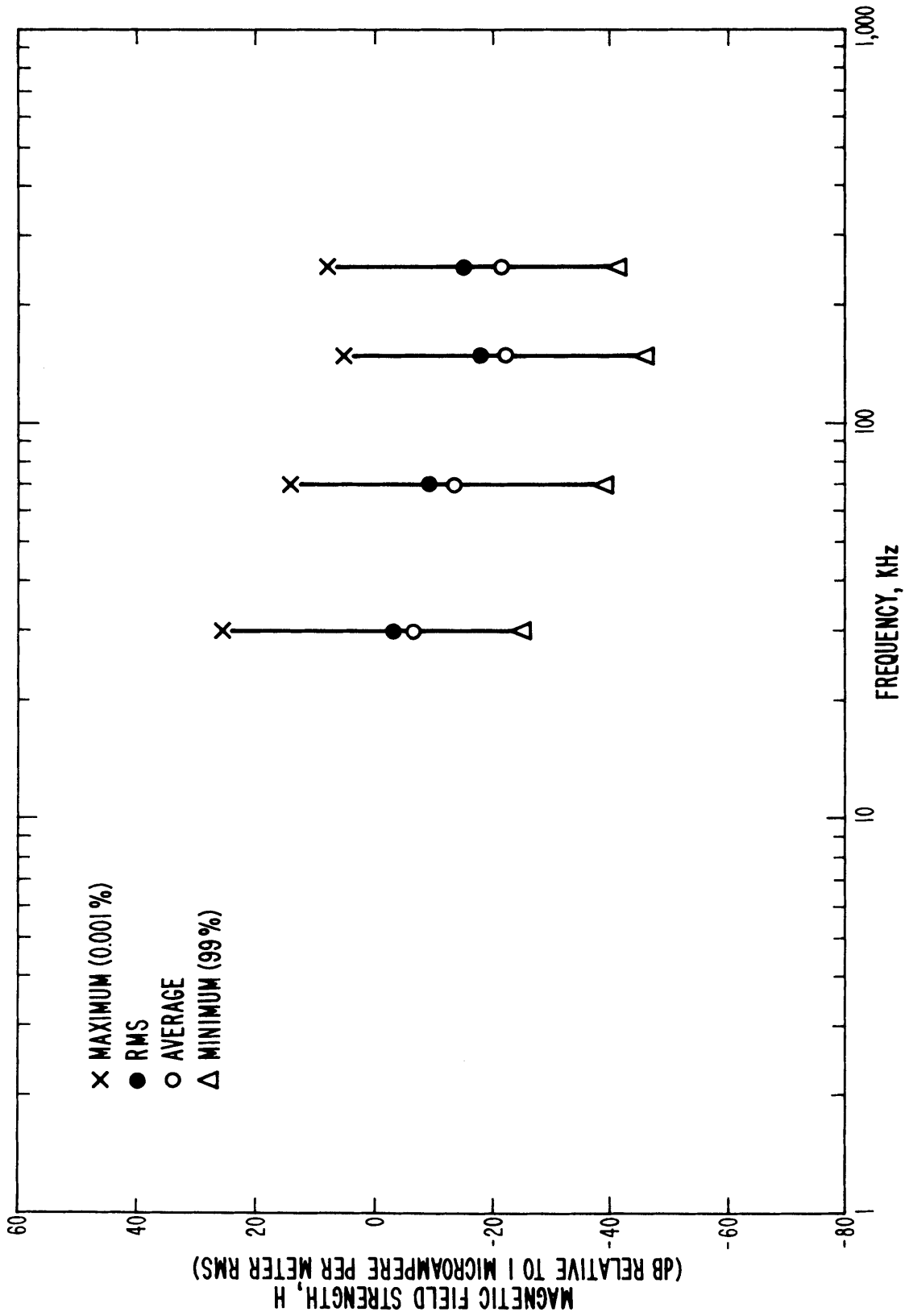

Figure 4-32 Summary curves of magnetic field strength excursions between 0.001% and 99% of the time as a function of frequency. 1450 level, Lucky Friday Mine, Horizontal (North-South) component, August 27, 1973.

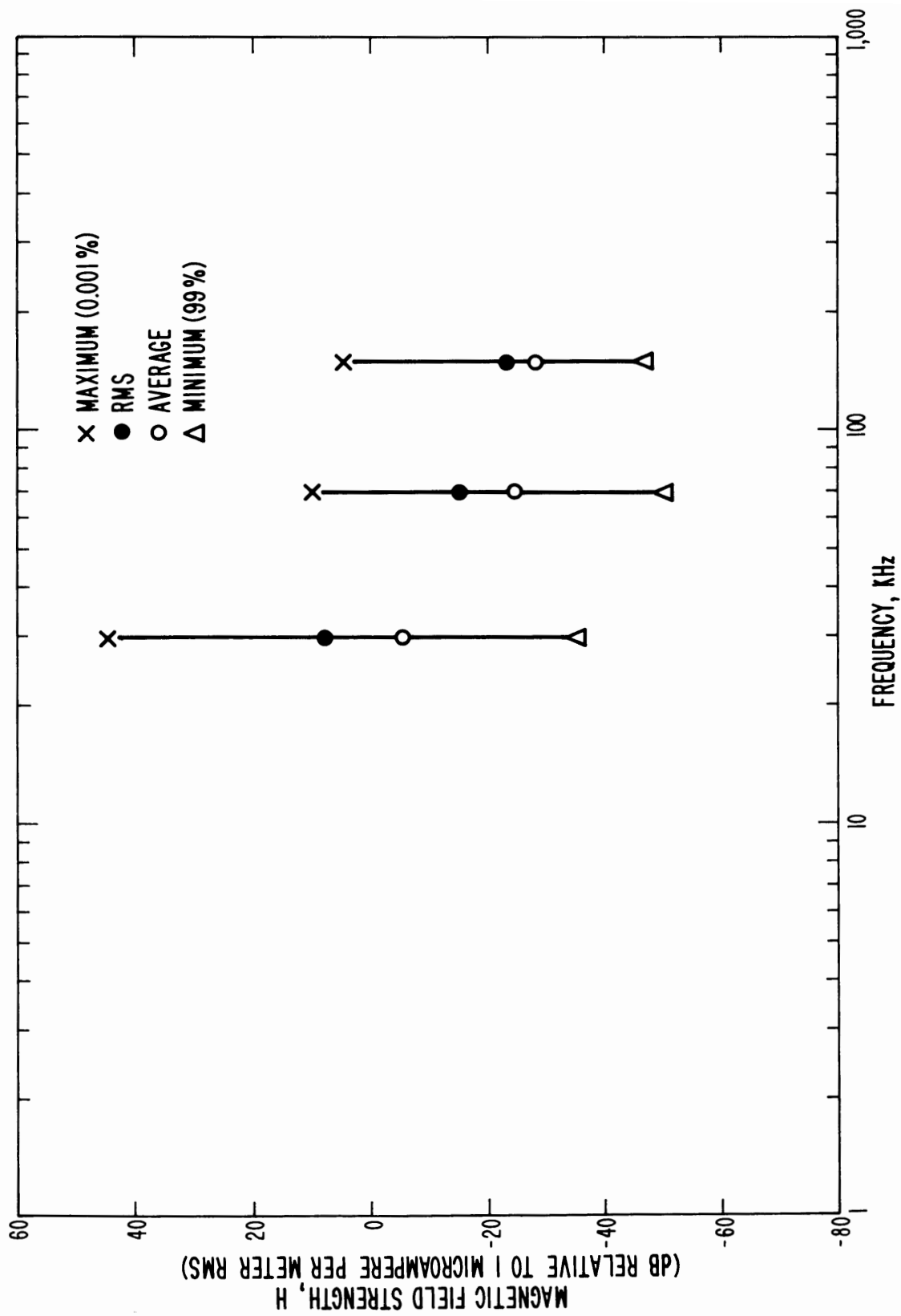

Figure 4-33 Summary curves of magnetic field strength excursions between 0.001% and 99% of the time as a function of frequency. 3050 level, Lucky Friday Mine, Horizontal (North-South) component, August 27, 1973.

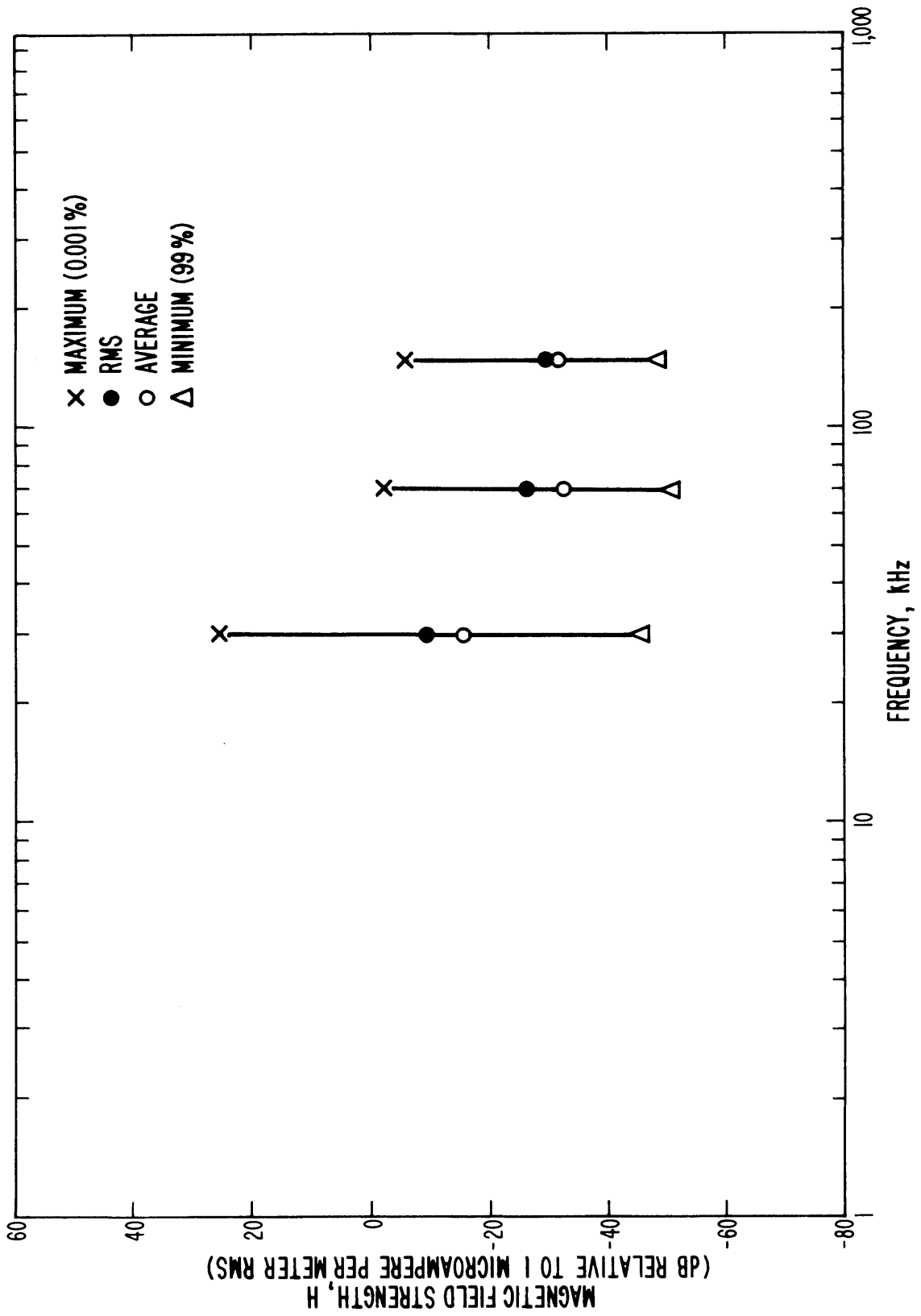

Figure 4-34 Summary curves of magnetic field strength excursions between 0.001% and 99% of the time as a function of frequency. 3050 level, Lucky Friday Mine, Vertical component, August 27, 1973.

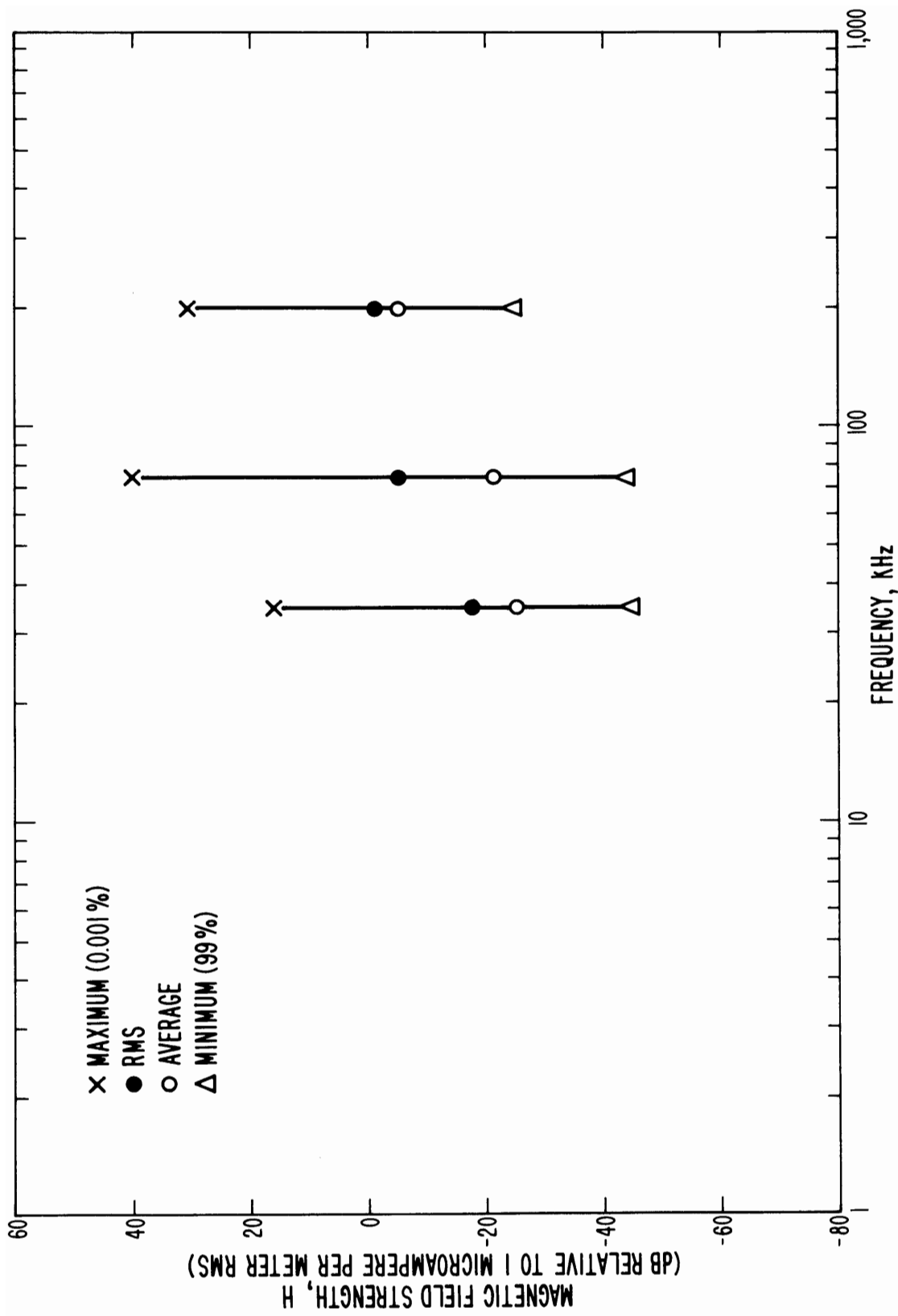

Figure 4-35 Summary curves of magnetic field strength excursions between 0.001% and 99% of the time as a function of frequency. 3650 level, Lucky Friday Mine, Horizontal (North-South) component, February 8, 1974.

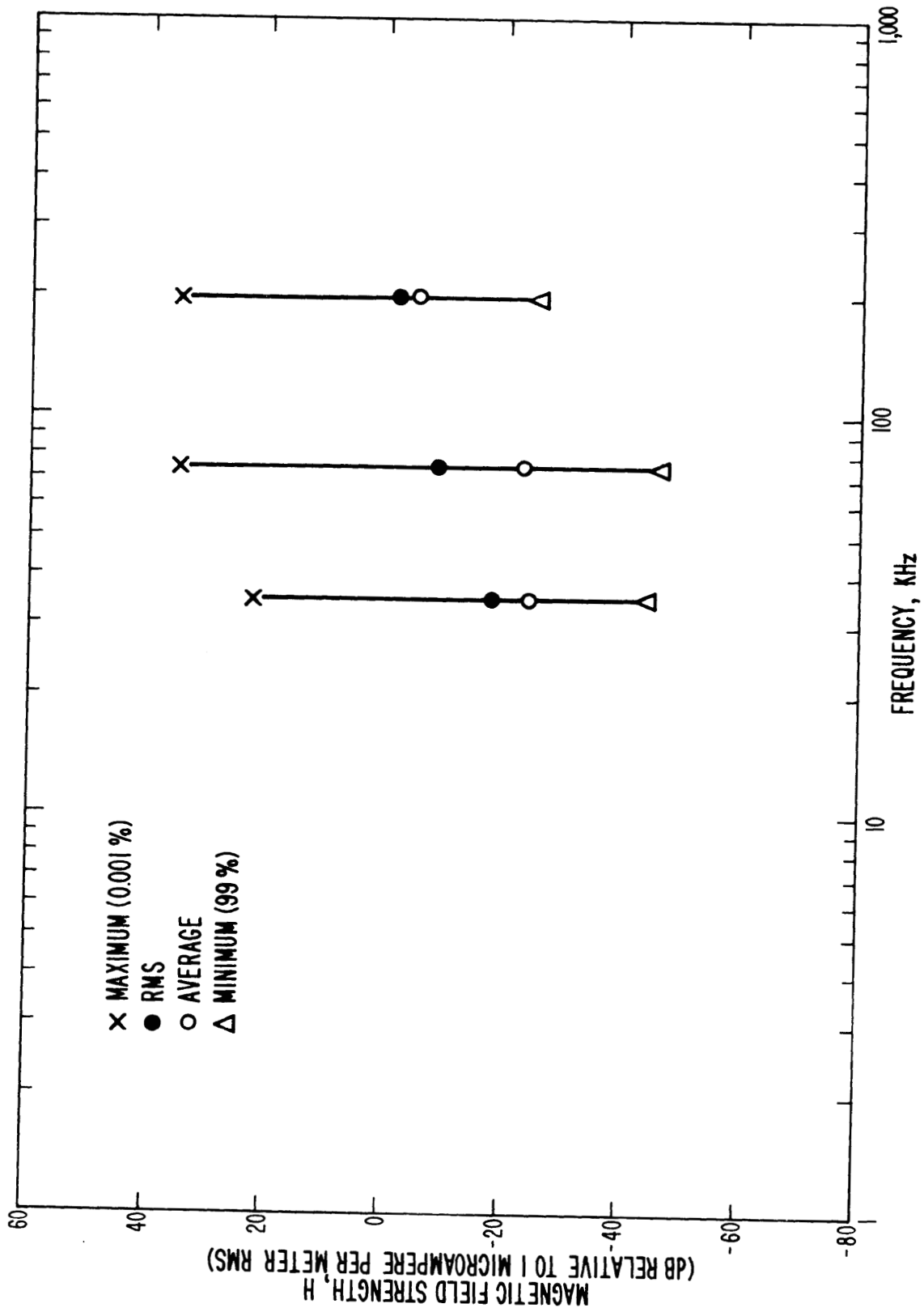

Figure 4-36 Summary curves of magnetic field strength excursions between 0.001% and 99% of the time as a function of frequency. 3650 level, Lucky Friday Mine, Vertical component, February 8, 1974.

5. NOISE AND ATTENUATION MEASUREMENTS ALONG THE HOIST ROPE

5.1 Noise Measurements

Measurements were made on two different days. On one day the mine was in operation; on the other day it was not. On the day the mine was in operation, measurements were made while the cage was in motion; when the mine was not in operation, measurements were made with the cage stopped at a number of levels. The cage was shorted to water pipes, and both "open" and "short" measurements were made. At 35 kHz, the readings were rather erratic, indicating either substantial variations with time, or nearby sources. The 50 kHz data showed standing wave patterns similar to those obtained in the attenuation measurements.

Values are in dB with respect to one microvolt across 50 ohms; the uncertainty is estimated as ± 5 dB. The air-core loop values could be calibrated in terms of microamperes per meter, but the field strength is really controlled by the current in the hoist rope (although coupling is not as tight as with the ferrite core), so only voltage units will be given.

The noise data for the time when the mine was not operating are shown in figures 5-1, 5-2, 5-3, and 5-4; data taken when the mine was in operation are shown in figures 5-5, 5-6, 5-7, and 5-8. Noise is somewhat higher during operation, but the variations indicate the basic problem with this type of measurement -- the cw measurement system is responding to the time variations, but in a way that masks the statistical range of values caused by transients and intermittents. The APD section gives data at some levels, but APD's were not recorded on the hoist.

5.2 Attenuation Measurements

Discrete-frequency signals were injected at the headframe, and signal strength measurements were made of the current at the cage at a number of levels. The plots show standing wave patterns. Either the short has some inductance, or the open has some capacitance, or both, as the equal-amplitude mark is at about 3600 feet (\approx 1100 meters) for 50 kHz, and if there were no stray effects, the equal amplitude ($\approx \lambda/8$) point should be at about 2500 feet (750 meters).

Actual attenuation is relatively low, only a few dB over the 4000 foot (1200 meter) length of cable. The standing waves due to an unterminated transmission line are clearly a more serious problem. Up to 20 dB variation may be expected from maxima to minima.

The signal-to-noise ratio looks very encouraging, unless the intermittent noise from the strong unknown source (plus 60 dB noise) combines with a minimum in a standing wave pattern (minus 20 dB signal). Even this worst case may be handled, but the margin is significantly reduced, especially near the working levels when the mine is in operation and where noise levels are highest.

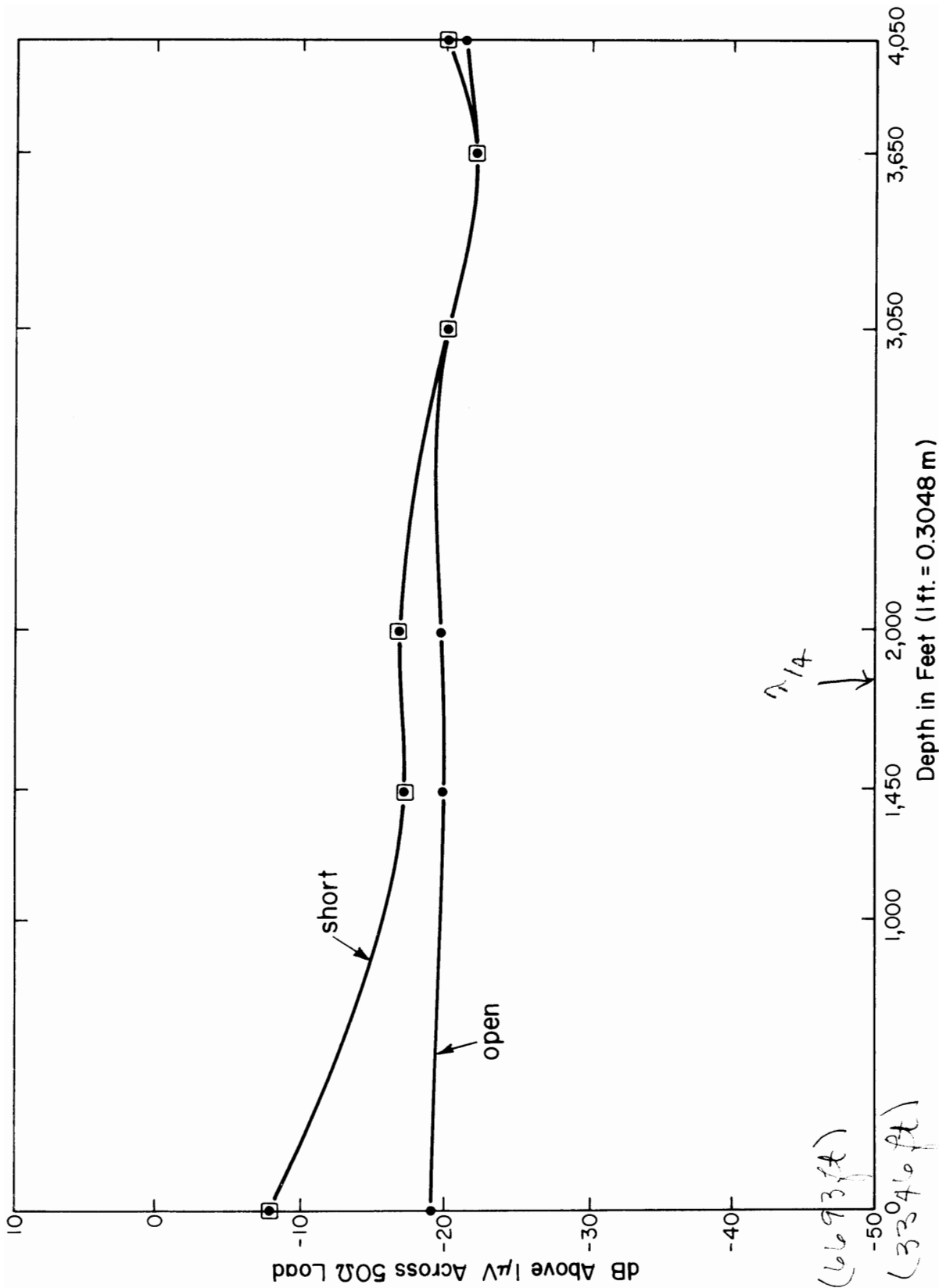

Figure 5-1 EM Noise in mine shaft, mine not in operation, air-core antenna on top of cage feeding 50 ohm load, frequency 49 kHz; predetection bandwidth of 1 kHz.

$\lambda = 2240 \text{ M} (6693 \text{ ft})$
 $\frac{\lambda}{2} = 1120 \text{ M} (33946 \text{ ft})$
 $\frac{\lambda}{4} = 560 \text{ M} (1673 \text{ ft})$

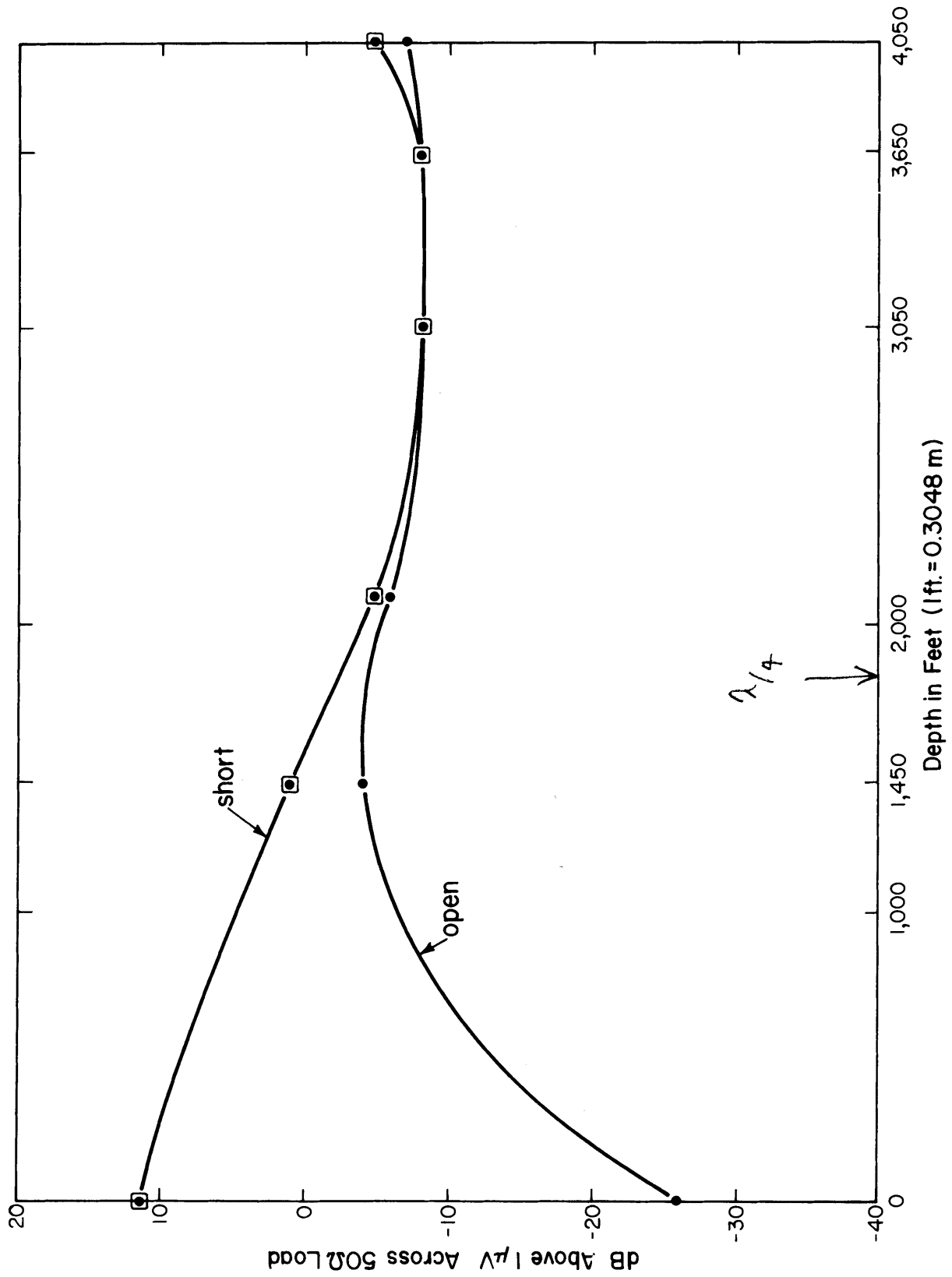

Figure 5-2 EM Noise in mine shaft, mine not in operation, ferrite core around hoist rope feeding 50 ohm load, frequency of 49 kHz, predetection bandwidth of 1 kHz.

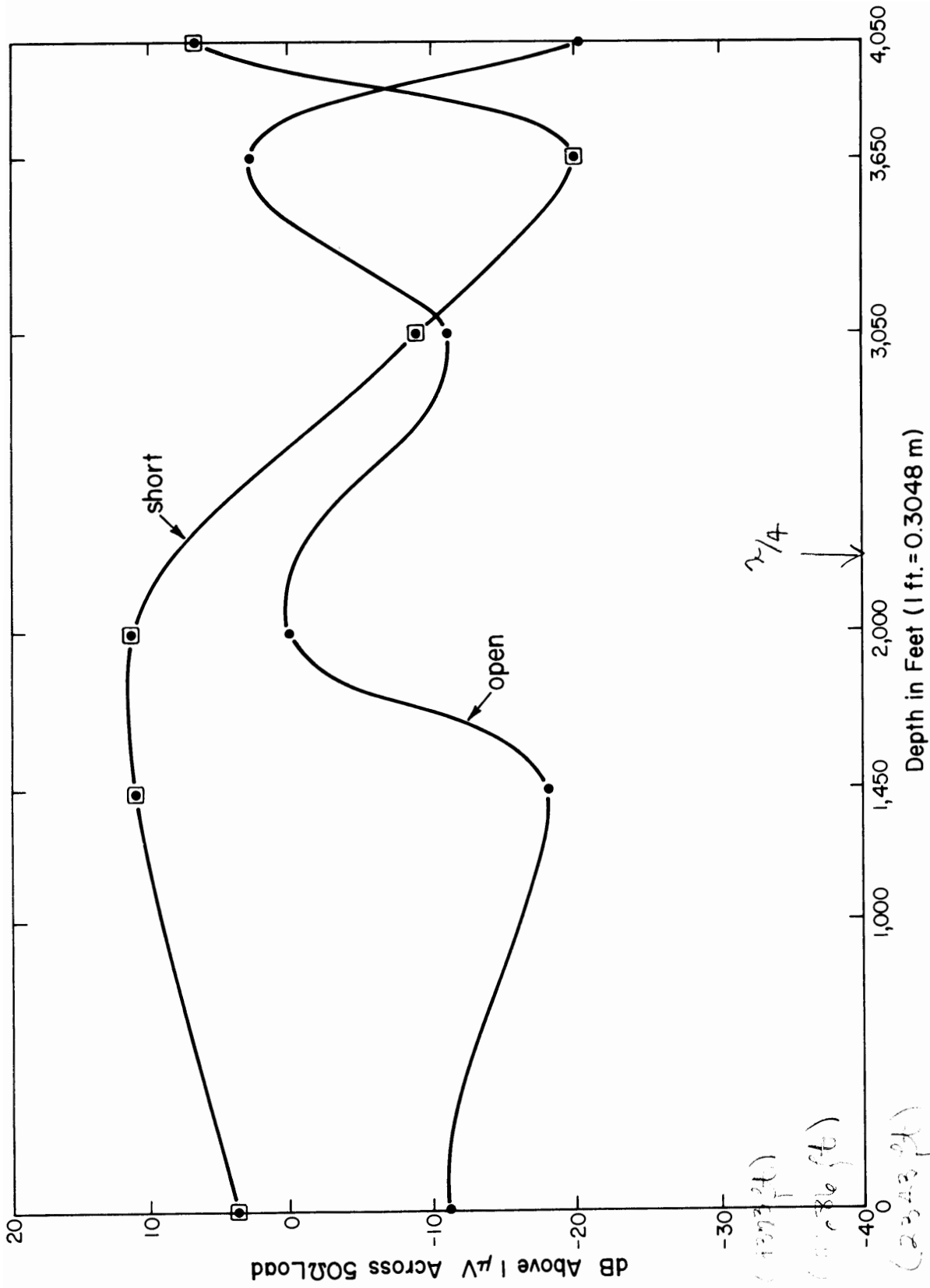

Figure 5-3 EM Noise in mine shaft, mine not in operation, air-core antenna on top of cage feeding 50 ohm load, frequency 35 kHz; predetection bandwidth of 1 kHz.

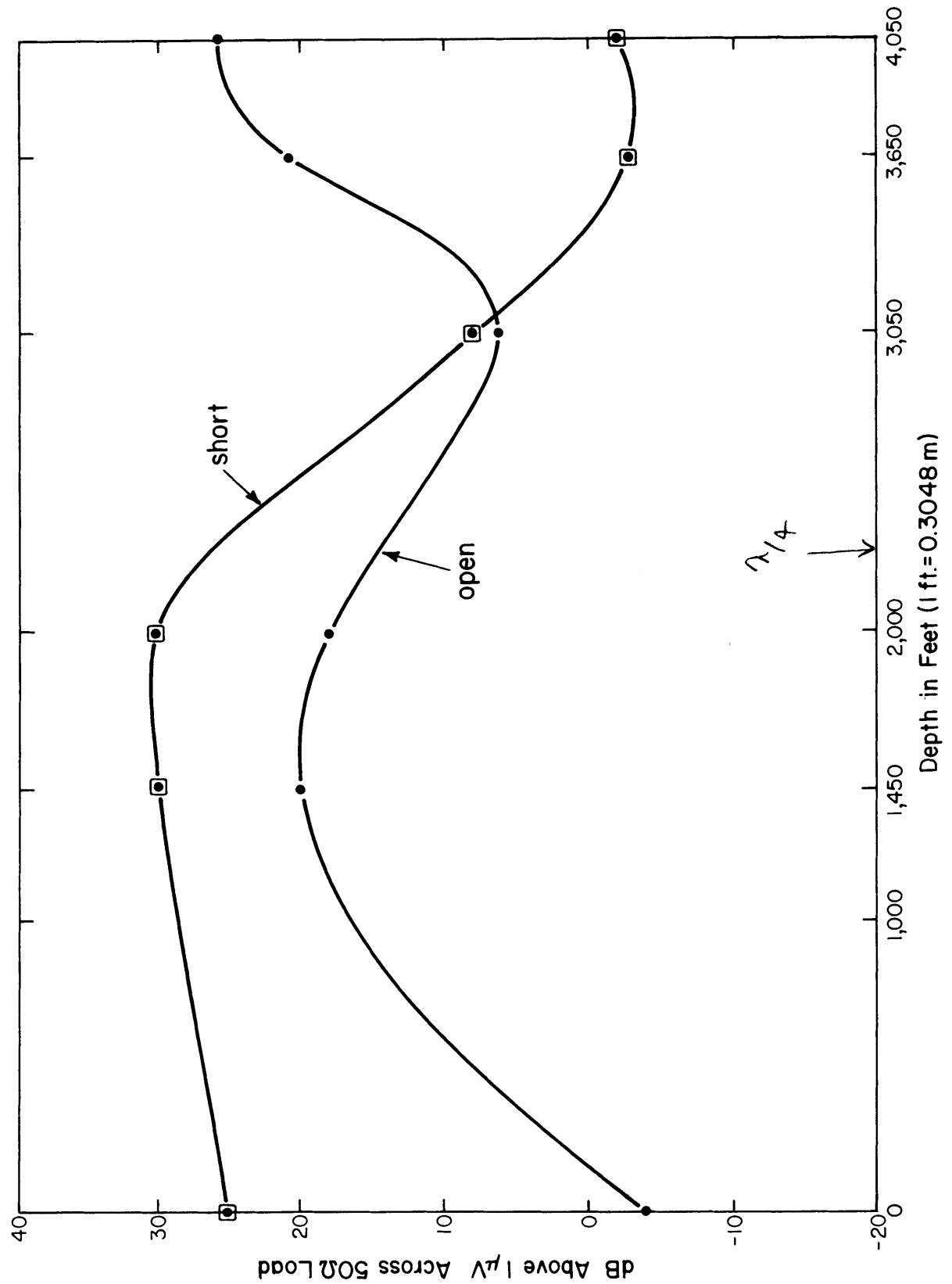

Figure 5-4 EM Noise in mine shaft, mine not in operation, ferrite core around hoist rope feeding 50 ohm load, frequency of 35 kHz, predetection bandwidth of 1 kHz.

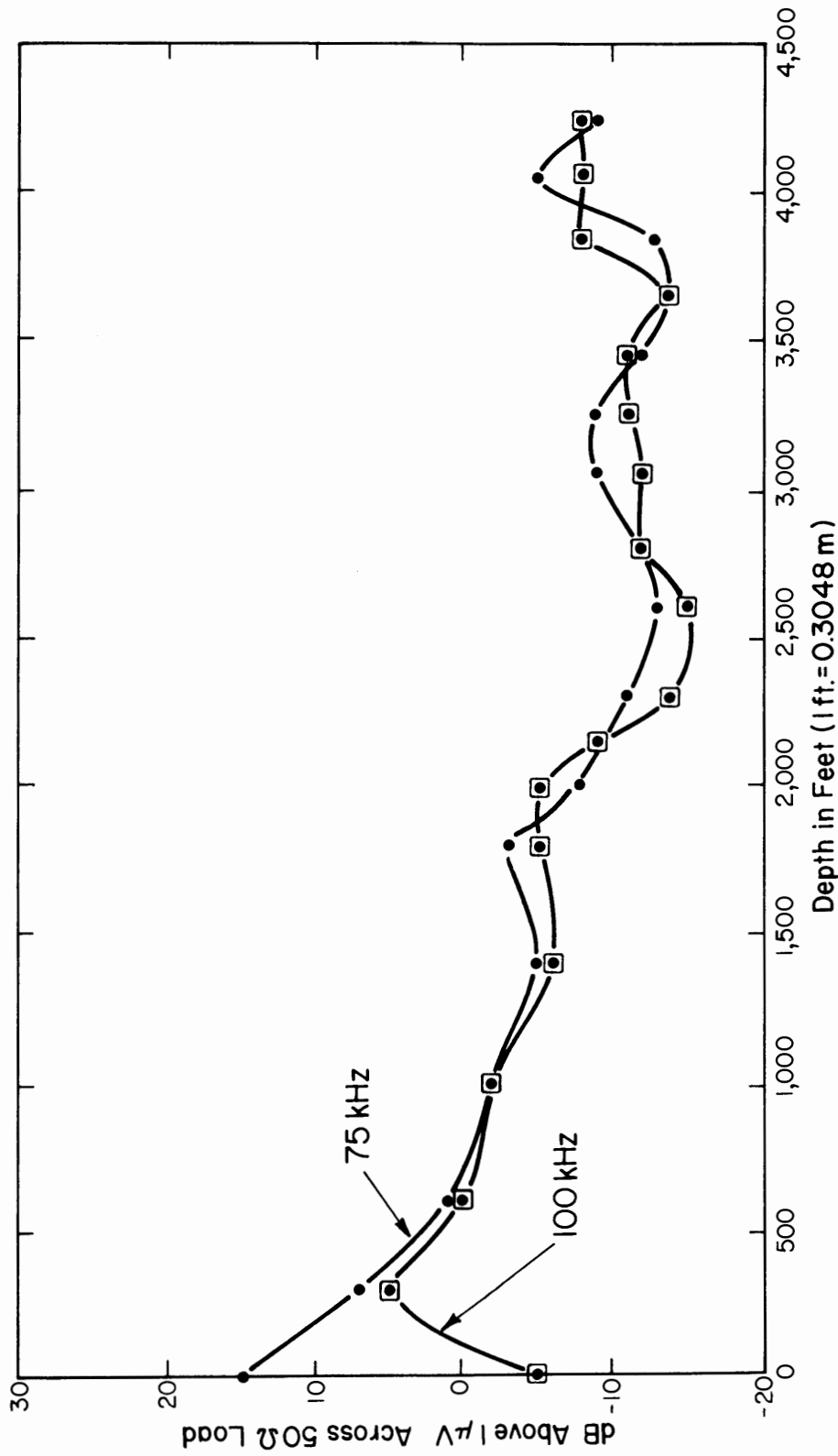

Figure 5-5 EM Noise in mine shaft, mine in operation, air-core antenna on top of cage feeding 50 ohm load; predetection bandwidth of 1 kHz.

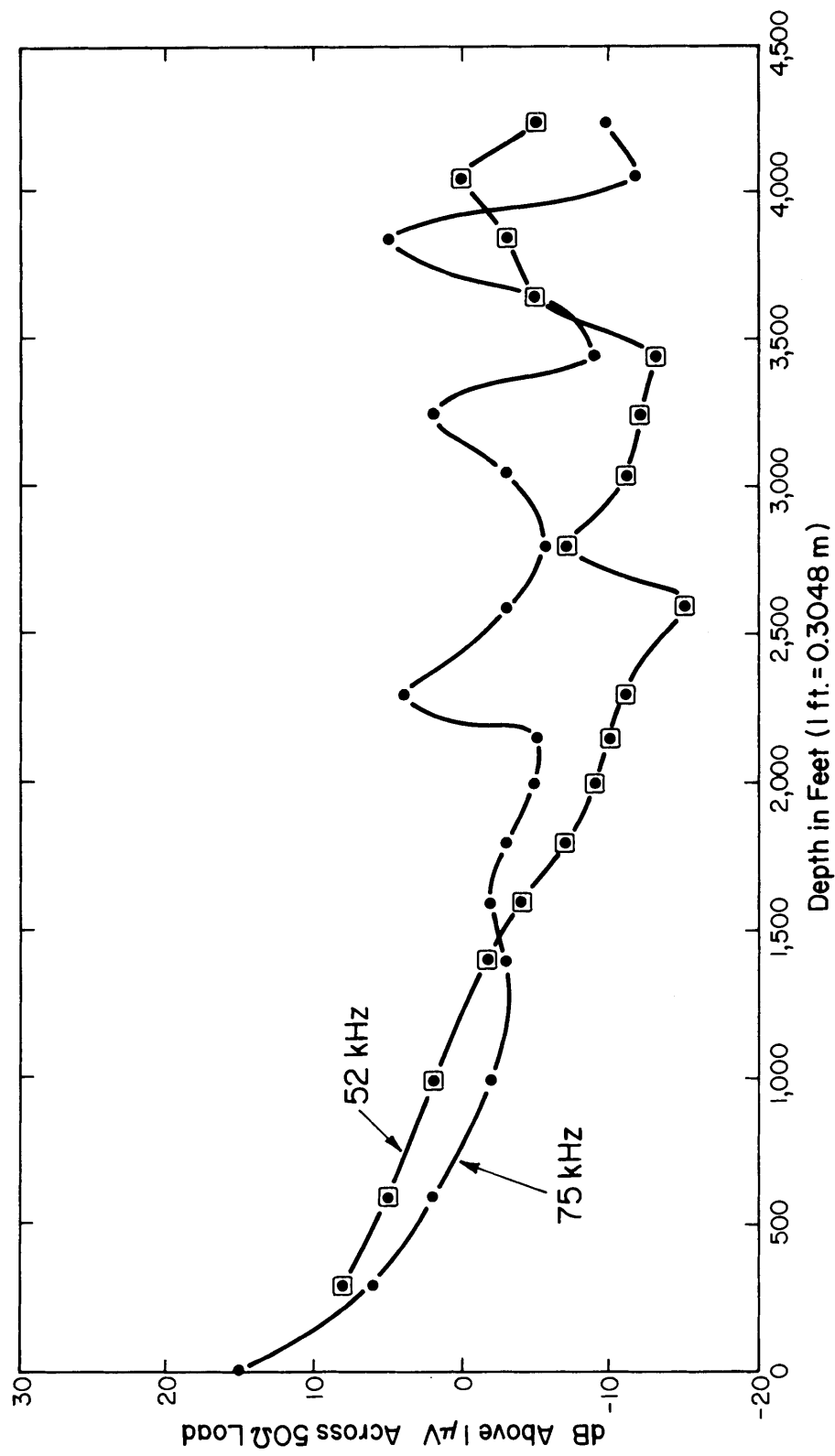

Figure 5-6 EM Noise in mine shaft, mine in operation, air-core antenna on top of cage feeding 50 ohm load; predetection bandwidth of 1 kHz.

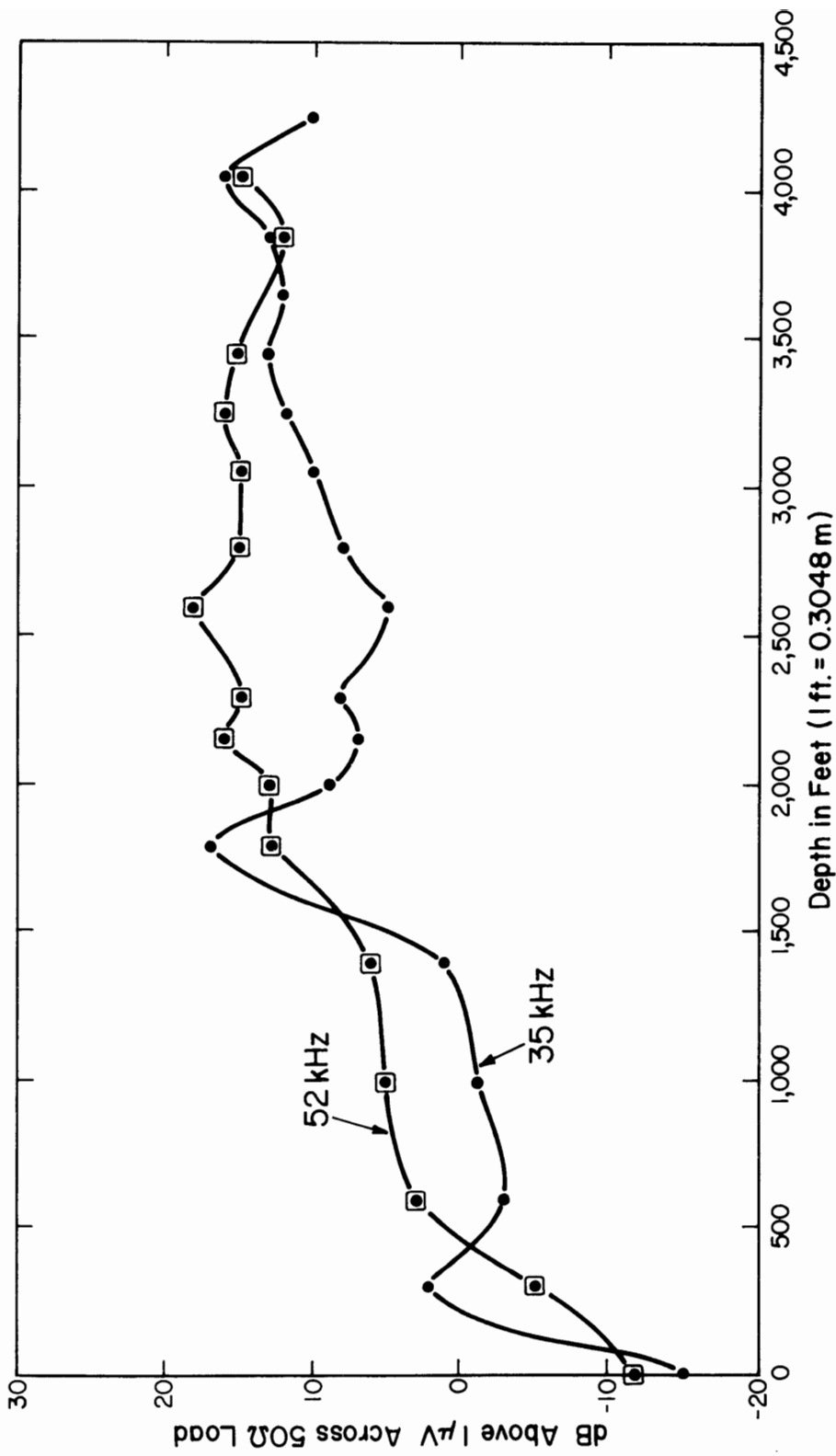

Figure 5-7 EM Noise in mine shaft, mine in operation, ferrite core around hoist rope feeding 50 ohm load; predetection bandwidth of 1 kHz.

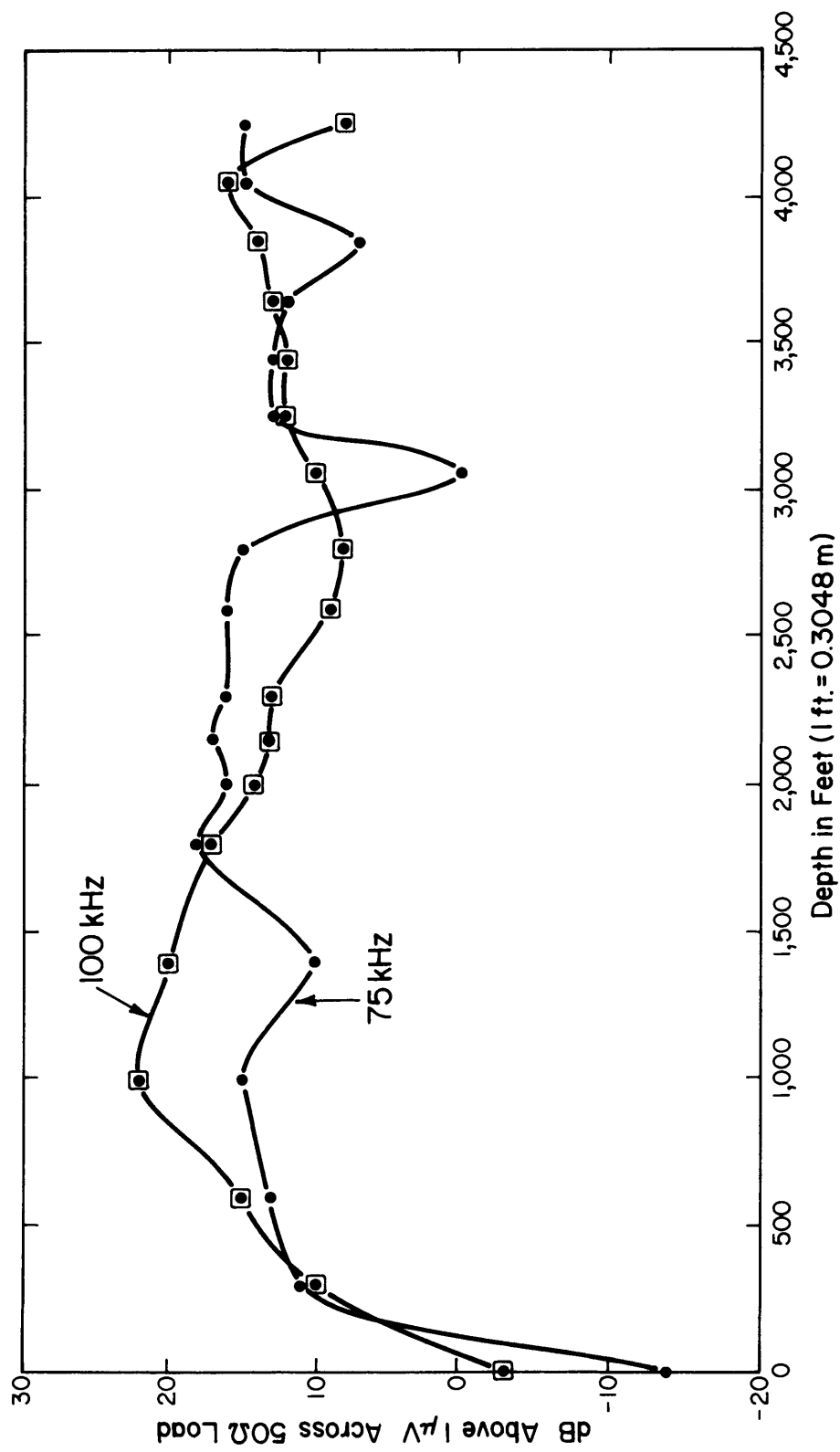

Figure 5-8 EM Noise in mine shaft, mine in operation, ferrite core around hoist rope feeding 50 ohm load; predetection bandwidth of 1 kHz.

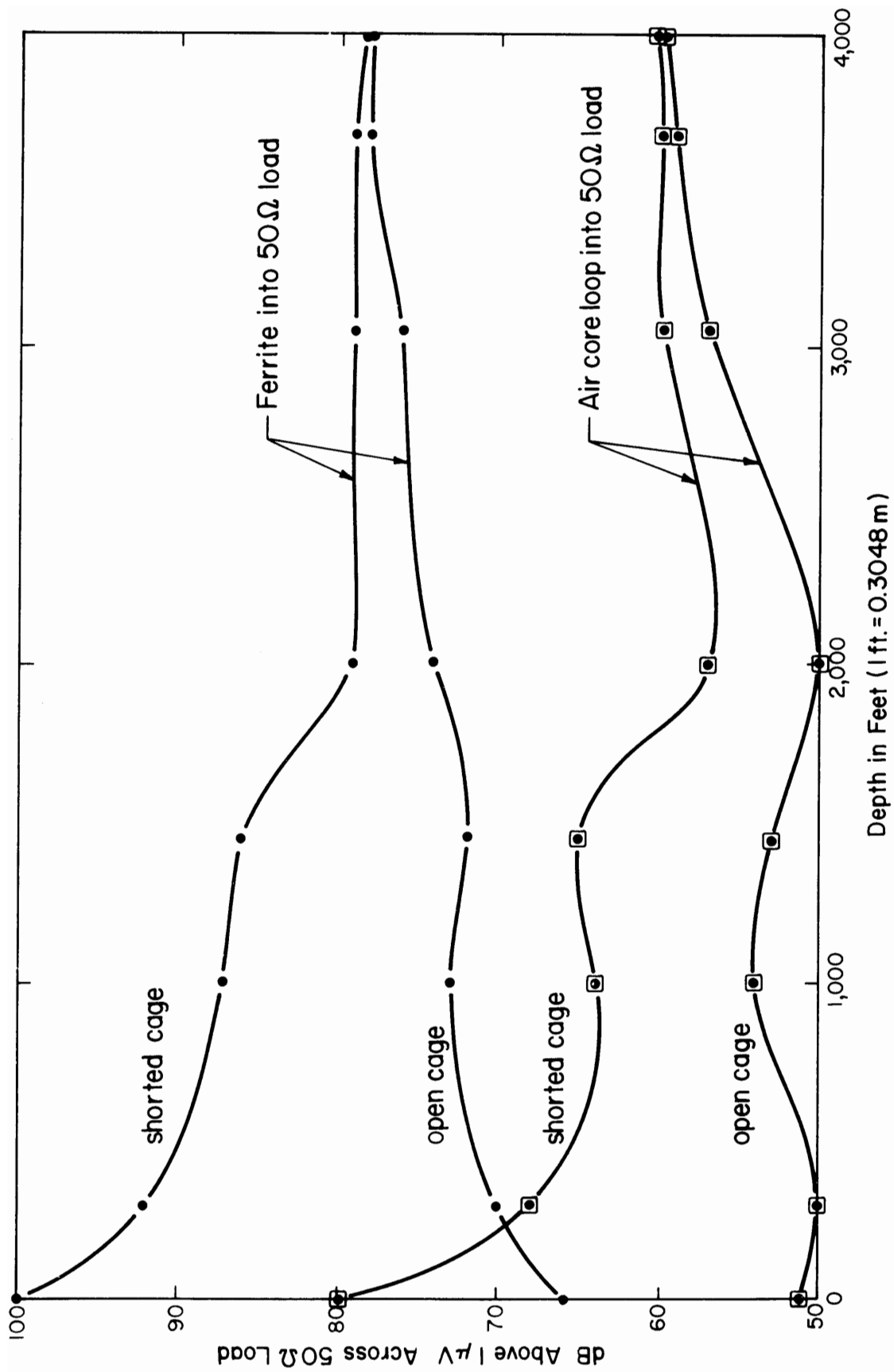

Figure 5-9 Received signal at cage from 35 kHz source at headframe, 1 kHz predetection bandwidth.

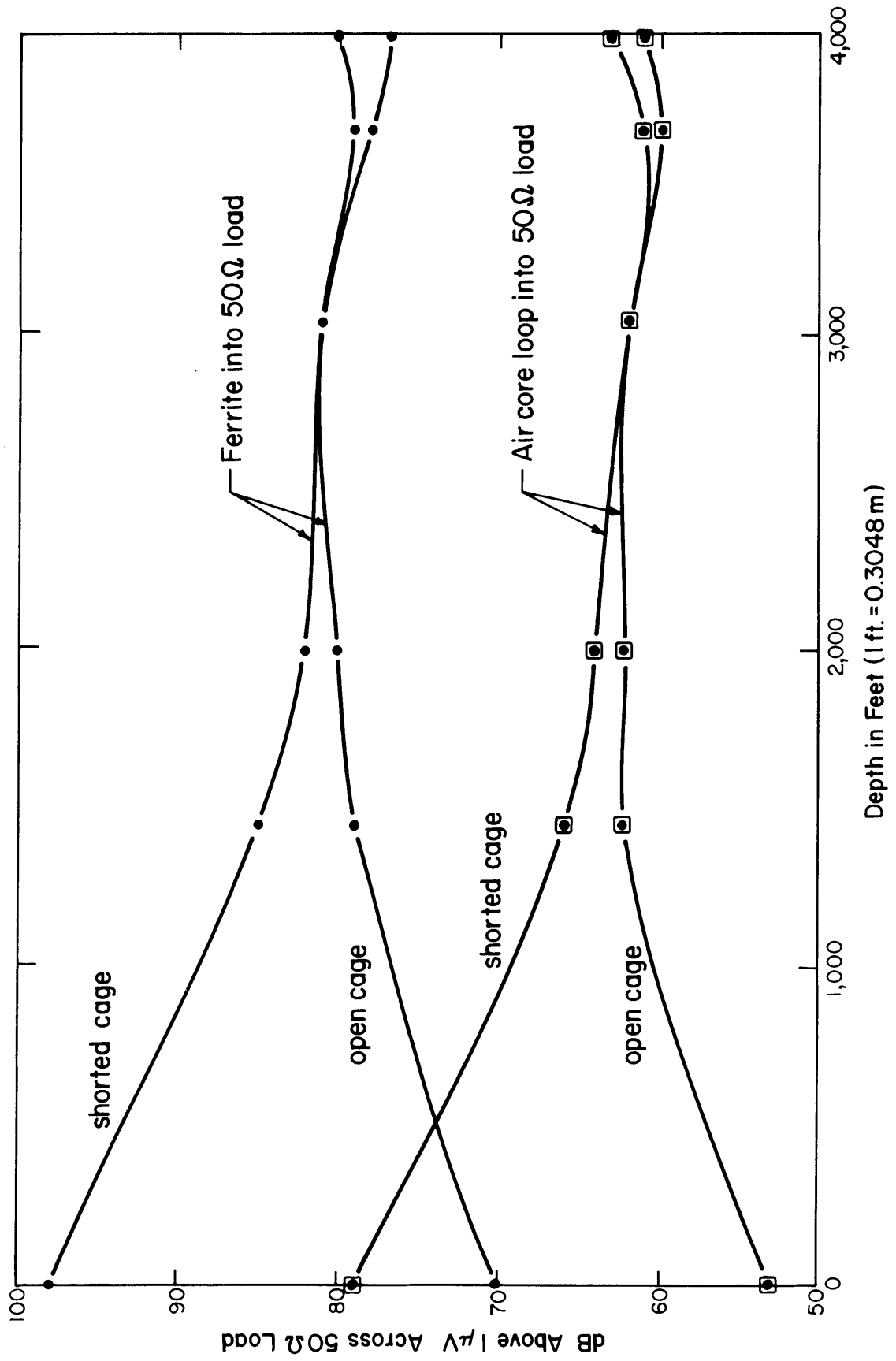

Figure 5-10 Received signal at cage from 50 kHz source at headframe, 1 kHz predetection bandwidth.

6. CONCLUSIONS

The electromagnetic interference in Lucky Friday Mine is somewhat lower than many other mines, most of the time. However, there is some unknown source of noise that is present on an intermittent basis, and during these times, the spectrum from 10 kHz to 200 kHz is subject to levels 60 dB above ambient from 50 to 100 kHz. This noise may last seconds or even minutes; it is not similar in nature to noise from very short-duration transients.

Noise near neon lights such as are common in cities cause considerably higher power-line harmonics than occur in most rural areas. We have now obtained absolute data on this type of noise.

Unterminated transmission lines formed by hoist ropes give strong standing waves.

7. RECOMMENDATIONS

Effort should be made to determine the source of the high-level noise. On hoist phones, standing wave variations must be taken into account in designs.

8. ACKNOWLEDGMENTS

Those making significant contributions to this program are as follows: laboratory development and field use of measurement equipment, Ed Neisen, Doug Schulze, and Tom Bremer; data processing, Anne Rumfelt, Nancy Tomoeda, Frank Cowley, and David Stearns. Those making valuable but less time-consuming contributions are Gerry Reeve, Bob Matheson, Don Spaulding, John Chukoski, Lorne Matheson, Dave Lewis, and Sharon Foote.

Sharon Foote and Janet Jasa typed tirelessly through many versions. Jocelyn Spencer and Barbara Bolton provided drafting assistance.

Finally, none of this would have been possible without excellent cooperation from various people in the Hecla Mining Company. For arrangements we thank Wallace Crandall, George Wilhelm, and Art Brown; for much special assistance we thank Don Beck.

9. REFERENCES

- [1] Bensema, W.D., Kanda, M., Adams, J.W., Electromagnetic Noise in Robena No. 4 Coal Mine, NBS Tech. Note 654 (April 1974).
- [2] IEEE Dictionary of Electrical and Electronic Terms, The Institute of Electrical and Electronic Engineers, Inc., Std. 100 (1972).
- [3] Taggart, H.E. and Workman, J.L., Calibration Principles and Procedures for Field Strength Meters (30 Hz to 1 GHz), NBS Tech. Note 370 (March 1969).
- [4] Adams, J.W., Bensema, W.D., Kanda, M., Electromagnetic Noise in Grace Hardrock Mine, NBS Tech. Note 657 (June 1974).
- [5] Crichlow, W.Q., et al., Amplitude-Probability Distributions for Atmospheric Radio Noise, NBS Monograph 23 (1960b).
- [6] Thompsom, W.I., III, Bibliography of Ground Vehicle Communications and Control, AKWIC index, Report No. DOT-TSC-UMTA-71-3 (July 1971).
- [7] Spaulding, A.D. and Disney, R.T., Man-Made Radio Noise. Part 1: Estimates for Business, Residential, and Rural Areas, OT Report 74-38 (June 1974).

10. APPENDIX

Decoding of Spectrum Captions

Spectrum captions are generally organized into the following format:

First line: MP NDT NZS NDA NPO RC DF date, time, frame, serial, where

MP = Two's power of length of Fourier transform, example, 2^{MP} where MP = 12
NDT = Detrending option, example, 0 (dc removed)
NZS = Restart spectral average after output, example, 0 (restarted)
NDA = Data segment advance increment, example, 2048
NPO = Number of spectra averaged between output calls, example, 20
RC = Integration time in seconds per spectra, example, 0.168
DF = Resolution bandwidth, spectral estimate spacing in hertz, example, 62.5
Date = Date of computer processing, example, 03/21/73
Time = Time of computer processing, example, 15:06:34
Frame = Frame set number, example, 10
Serial = Film frame serial number, example, 42.

Second line: DTA DA(1) DA(2) DA(3) NSA NRP NPP, where

DTA = Detrending filter parameter α , example, 0.00195
DA(1) = Detrending filter average, K=1, example, 59.4
DA(2) = Detrending filter average, K=2, example, 0
DA(3) = Detrending filter average, K=3, example, 0
NSA = Number of periodograms averaged, example, 20
NRP = Number of data points processed since spectrum initialization, example, 43008
NPP = Number of data points processed since data initialization, example, 43008.

Third line: RUN, SESSION, MONTH, DAY, YEAR Gain corr., rec. =
tot. constr. =, where
Run and Session = the title of the portrayed frame identifying
the digitizing session and run number,
example, 21 83
Month, Day, Year = date data were recorded in the mine,
example, 8 25 73
Gain corr. rec. = receiver gain correction, example, -6
tot. const. = constant gain correction of entire system,
example, 46.4

Fourth line: C =, RG =, DG =, FG =, AG =, where
C = correction curve used with data, example, 25
RG = receiver gain and accompanying correction in dB added to
the data, example, 200 (-6 dB)
DG = digitizer gain, example, 0
FG = filter gain in dB, often rounded to nearest single digit,
example, 0
AG = absolute gain correction added to data, example, 52

Fifth line: Top of Scale, Standard Error, Spectral Peak, where
Top of Scale = largest scale marking for computer drawn
graph, example, 1.000+004 (1.0×10^4)
Standard Error = standard error of curve, example, 0.3162
Spectral Peak = largest spectral peak observed, example,
4.108+003 (4.108×10^3)

| | | | |
|--|--|--|---------------------------------|
| U.S. DEPT. OF COMM. BIBLIOGRAPHIC DATA SHEET | 1. PUBLICATION OR REPORT NO. NBSIR 74-391 | 2. Gov't Accession No. | 3. Recipient's Accession No. |
| 4. TITLE AND SUBTITLE Electromagnetic Noise in Lucky Friday Mine | | 5. Publication Date October 1974 | 6. Performing Organization Code |
| 7. AUTHOR(S) W.W. Scott, J.W. Adams, W.D. Bensema, H. Dobroski | | 8. Performing Organ. Report No. | |
| 9. PERFORMING ORGANIZATION NAME AND ADDRESS NATIONAL BUREAU OF STANDARDS DEPARTMENT OF COMMERCE WASHINGTON, D.C. 20234 | | 10. Project/Task/Work Unit No. 2768412 | 11. Contract/Grant No. |
| 12. Sponsoring Organization Name and Complete Address (Street, City, State, ZIP) U.S. Bureau of Mines Pittsburgh Mining and Safety Research Center 4800 Forbes Avenue Pittsburgh, Pennsylvania 15213 | | 13. Type of Report & Period Covered | 14. Sponsoring Agency Code |
| 15. SUPPLEMENTARY NOTES | | | |
| 16. ABSTRACT (A 200-word or less factual summary of most significant information. If document includes a significant bibliography or literature survey, mention it here.) Measurements of the absolute value of electromagnetic noise and attenuation along a hoist rope were made in an operating hard-rock mine, Lucky Friday Mine, located near Wallace, Idaho. Spectra of electromagnetic noise generated by various pieces of equipment, spectra of specific noise signals at various depths, and noise and attenuation on the 4250 foot (1295 meter) hoist, were measured. Three techniques were used to make the measurements. First, noise was measured over the entire electromagnetic spectrum of interest for brief time periods. Data were recorded using broadband analog magnetic tape for later transformation to spectral plots. Second, noise amplitudes were recorded at several discrete frequencies for a sufficient amount of time to provide data for amplitude probability distributions. A third technique gave attenuation data through the direct measurement of field strength at various depths. The specific measured results are given in a number of spectral plots, amplitude probability distribution plots and amplitude curves as a function of depth. | | | |
| 17. KEY WORDS (six to twelve entries; alphabetical order; capitalize only the first letter of the first key word unless a proper name; separated by semicolons) Amplitude probability distribution; digital data, electromagnetic interference; electromagnetic noise; emergency communications; Fast Fourier Transform; Gaussian distribution; impulsive noise; magnetic field strength; measurement instrumentation; mine noise; spectral density; time-dependent spectral density. | | | |
| 18. AVAILABILITY <input checked="" type="checkbox"/> Unlimited <input type="checkbox"/> For Official Distribution. Do Not Release to NTIS <input type="checkbox"/> Order From Sup. of Doc., U.S. Government Printing Office Washington, D.C. 20402, SD Cat. No. C13 <input type="checkbox"/> Order From National Technical Information Service (NTIS) Springfield, Virginia 22151 | 19. SECURITY CLASS (THIS REPORT) UNCLASSIFIED | 21. NO. OF PAGES | |
| | | 20. SECURITY CLASS (THIS PAGE) UNCLASSIFIED | 22. Price |