

DESIGNS FOR RAPID IN-SITU SEALING

**M. Sapko
E. Weiss**

Natl Inst for Occupatnl Sfty & Health
Pittsburgh, PA

J. Trackemas
RAG American Coal Co.
Waynesburg, PA

C. Stephan
Mine Sfty & Health Admn
Pittsburgh, PA

ABSTRACT

The National Institute for Occupational Safety and Health (NIOSH), Pittsburgh Research Laboratory (PRL), in collaboration with the Mine Safety and Health Administration (MSHA), the mining industry, and seal manufacturers recently conducted a series of full-scale experiments within the underground experimental mine at PRL's Lake Lynn Laboratory. The purpose of the experiments was to evaluate the explosion-resistant characteristics of several new seal designs for rapid deployment during mine emergencies. These seals can be deployed in 6 to 10 hr and are capable of withstanding explosion overpressures in excess of 140 kPa (20 psi). These novel seal designs use available mine materials, do not require conventional rib hitching, and, most importantly, can substantially reduce exposure time for coal miners during sealing and mine recovery operations.

INTRODUCTION

The probability of a mine fire occurring in the U.S. is low, but should one occur the local fire area must be controlled rapidly, safely, and efficiently. Mine fires that are not controlled within the first 2 hr generally require sealing at a cost of hundreds of thousands of dollars a day for up to several weeks of active fire fighting. Time is most important when constructing seals and miners may be placed at great risk during construction. Even when mine fires are successfully sealed, experience has shown that there is a high probability of explosions occurring within 72 hr of sealing, therefore a seal should be capable of withstanding explosion overpressure shortly after construction. Controlling a fire by reducing the exchange of oxygen

requires surrounding the fire area quickly with barriers capable of withstanding moderate-strength explosions as the contained atmosphere transitions from the fuel-lean to fuel-rich condition. Once the fire becomes established, the chances for successful in-mine sealing decrease rapidly with each hour that passes.

A priori planning for sealing is paramount to successfully controlling an underground fire and for rapidly constructing a seal during mine recovery. Rapid sealing of a mine section should be part of normal mine planning and layout. In the event of a fire, having developed sealing strategies can significantly improve miner safety and reduce the loss of time and dollars. The published works by D. Mitchell (1971 and 1990) provide important guidelines for sealing fire areas that should be considered when developing specific mine strategies. The location of the seal is as important as the quality of the seal. Seals should be located first in areas where the least number of seals are needed and the sealed area should be large enough for hot, combustible gases to expand without endangering the miners who are building the seals. The bottom, ribs, and roof should be firm and above potential flood levels. Seals should be constructed in a level area, preferably below the elevation of the fire, and placed in areas where the roof is sufficiently supported. Storing sealing materials at key locations prior to the occurrence of a fire can significantly minimize construction delays and greatly reduce the burden on the miners who would be required to move and place these materials at the sealing location while wearing self-contained breathing apparatus. Also, communication with the surface should be maintained to all sealing areas, and the miners constructing the seals should be able to retreat swiftly to safety.

If the decision is made to seal a section of a mine, the quicker the seals are built the less exposure to miners. As part of an effective

sealing operation, materials should be readily available at the mine, should require minimum time for construction, should minimize air leakage into and out of the fire area, should not crush out with roof/floor convergence, and should be capable of withstanding explosion overpressures that frequently occur behind fire seals. 30 CFR 75.335 (1997) requires a seal to “withstand a static horizontal pressure of 20 pounds per square inch (140 kPa).” Construction of the standard-type solid-concrete-block seal with floor and rib hitching as defined in the CFR requires considerable time.

The strength of the standard-type solid-concrete-block seal is due primarily to an arching action that takes place within the thickness of the seal, which applies lateral thrust to the coal ribs. However, strength increase due to arching action between the mine roof and floor is not realized in most cases due to inadequate coupling between the top of the seal and the mine roof. During construction of the standard-type solid-concrete-block seal, it is difficult to uniformly load or completely fill the gap between the top of the seal and the mine roof with mortar; thus the effectiveness of vertical arching becomes critical. In the field, most of the standard-type block seal strength comes from the rib-to-rib arching action. An alternative design concept is based on improving the arching action by providing better coupling between the seal and the mine roof, which can be done by pre-loading the seal with pressurized grout bags.

To address these issues, the following organizations participated in a joint research effort: PRL; Strata Products, Inc.; RAG, American Coal Company; FOMO Products, Inc.; Burrell Mining Products International, Inc.; and HeiTech Corporation. The project's purpose was to evaluate the strength characteristics and air-leakage resistance of a pre-loaded wood crib seal design; a light-weight, cementitious Omega block* seal design; and a design consisting of a series of grout-filled bags. These seals were specifically designed for rapid construction and quick setting as compared to the more standard method of constructing a mortared concrete block seal design hitched or keyed into the mine ribs and floor. Standard seal evaluations within the Lake Lynn Experimental Mine (LLEM) require that the seal be allowed to cure a minimum of 28 days before subjecting the seal to the required 140 kPa explosion pressure. Given the time restraint of mine fire scenarios, these rapid seal designs were engineered to be capable of withstanding a 140 kPa explosion pressure 24 hr after construction.

This report discusses the construction techniques, testing methods, and explosion performance data for the seal designs under consideration for use during rapid sealing operations, or for general use in areas with some roof-to-floor convergence.

EXPERIMENTAL MINE AND TEST PROCEDURES

Mine Explosion Tests

All of the mine explosion characteristics and air-leakage tests on the various seal designs were conducted at the LLEM (Mattes et al. 1983; Sapko et al. 1987; Triebisch and Sapko 1990). The LLEM is located approximately 80 km southeast of Pittsburgh, near Fairchance, PA. The LLEM is one of the world's foremost mining laboratories for conducting large-scale health and safety research. This laboratory is unique in that it can simulate current U.S. coal mine geometries for a variety of mining scenarios, including multiple-entry, room and pillar mining, and longwall mining. The dimensions of the drifts and crosscuts are typical of modern U.S. geometries for coal mine entries and range from 5.5 to 6.0 m wide and approximately 2 m

*Reference to specific products is for informational purposes and does not imply endorsement by NIOSH.

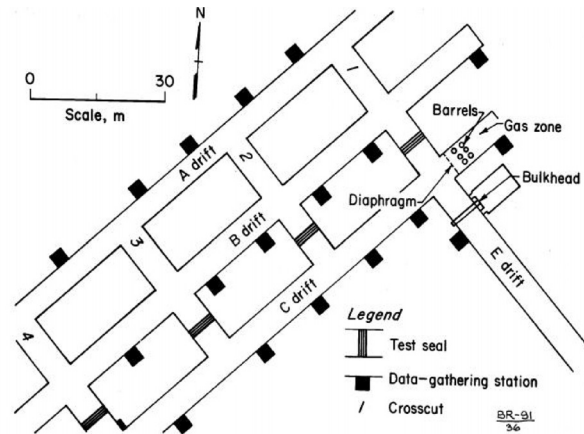

Figure 1 - Seal test area in the Lake Lynn Experimental Mine

high.

Figure 1 shows an expanded view of the seal test area in the multiple entry section of the LLEM. All of the seals and stoppings were constructed in the crosscuts between the B and C drifts. The nominal dimensions of these crosscuts are approximately 2-m high by 6-m wide.

Prior to each explosion test, a 60-ton hydraulically operated, track-mounted, concrete and steel bulkhead was positioned across E drift to contain the explosion pressures in C drift. For a typical evaluation test on a seal design for use in a U.S. coal mine, 19 m³ (661 ft³) of natural gas (~97% CH₄) was injected into the closed end of C drift. A plastic diaphragm was used to contain the natural gas and air mixture within the first 14.3 m of the entry, resulting in a ~210-m³ gas ignition zone. An electric fan with an explosion-proof motor housing was used to mix the natural gas with the air in the ignition zone. A sample line within the ignition zone was used to continuously monitor the gas concentrations using an infrared analyzer. In addition, samples were collected in evacuated test tubes and sent to the PRL analytical laboratory for more accurate analyses using gas chromatography (GC). The GC analyses verified the infrared analyzer readings of ~9% of methane in air. Three electrically activated matches, in a triple-point configuration equally spaced across the face (closed end) of the entry, were used to ignite the flammable natural gas and air mixture. Barrels filled with water were located in the ignition zone to act as turbulence generators to achieve the projected 140 kPa pressure pulse. The pressure pulse generated by the ignition of this methane-air zone generally resulted in static pressures ranging from ~150 kPa (~22 psig) at crosscut X-1, 129kPa (~19 psig) X-2 to ~115 kPa (~17 psig) at X-3 the most outby seal.

To ensure that all of the seal designs would undergo at least a 140 kPa explosion pressure pulse, a small amount of coal dust was used for several of these tests in addition to the natural gas ignition zone. The coal dust was loaded onto shelves that were suspended from the mine roof on 3-m increments starting at 13 m from the closed end (near the end of the natural gas ignition zone). When ignited, this coal dust increased the average explosion overpressure from ~140 kPa (20 psi) for the natural gas ignition zone itself to 185 kPa (26.5 psi) for the hybrid natural gas/coal dust ignition zone.

Instrumentation

Each drift has ten data-gathering stations inset in the rib wall. Each data-gathering station houses a strain gauge pressure transducer and an optical sensor to detect the flame arrival. The

pressure transducer is perpendicular to the entry length and therefore measures the static pressure generated by the explosion. The transducers were rated at 0-690 kPa (0-100 psia), with 0-5 V output, infinite resolution, and response time less than 1 ms. The flame sensors used silicon phototransistors, with a response time on the order of microseconds. These phototransistors were positioned back from the front window of the flame sensors to limit the field of view and precisely indicate arrival of the leading edge of the flame at each station. Pressure transducers (0-410 kPa or 0-60 psia) were installed in the face of each seal to measure the actual pressure loading. Linear variable differential transformers (LVDTs) were used to measure displacement of the mid-point of the back side of each seal during pressure loading. The LVDT was attached to the back (B-drift side) of a seal via fishing line to protect the sensor from being destroyed in case of seal catastrophic rupture. The LVDTs provide a reliable method for precision measurement of linear displacement in the direction of the wall movement, perpendicular to the plane of the seal. The LVDT measures up to ± 8 cm (3 in) of bi-directional seal movement. The direction of displacement is indicated by the sign of the output voltage. The LVDT calibration is verified by varying the position of the fishing line at the seal by pre-determined distances and measuring the corresponding output voltage. The main body of each LVDT was attached to a steel frame located on the B-drift rib and connected to the seal via a 2.7- kg (6 lb) test fishing line. The spring-loaded LVDT maintains tension on the line.

The data gathered during the explosion tests were relayed from each of the data-gathering stations to an underground instrument room off C-drift and then to an outside control building. A high-speed, 64-channel, PC-based computer data acquisition system (DAS) was used to collect and analyze the data. This system collected the sensor data at a rate of 1,500 samples/sec over a 5-sec period. The data were then processed using LabView and Excel software and outputted in graphic and tabular form (discussed in the "Explosion and Air-Leakage Test Results" section). The reported data were averaged over 10 ms (15-point smoothing).

Air-Leakage Determinations

An important factor to be considered for any seal design is its impermeability, or its ability to minimize air leakage from one side of the seal to the other. Measurements of the air leakages across the seals were conducted before and after each of the explosion tests. A wooden framework with brattice cloth or curtain was erected across C drift outby the last seal position. This curtain effectively blocked the ventilation flow, which resulted in a pressurized area on the C-drift side of the seal. By increasing the speed of the four-level LLEM main ventilation fan while in the blowing mode, the resultant pressure exerted on the seals increased from approximately 0.25 kPa (1-in H₂O) for the lowest fan speed setting to nearly 1.0 kPa (3.7-in H₂O) for the highest fan speed setting.

On the B-drift side of each seal design, a diaphragm of brattice with a 465-cm² center opening was installed across each crosscut. A vane anemometer was used to monitor the air flow through the opening on the diaphragm to determine the leakage rates through the seal. During these air-leakage tests, a pressure gauge was attached to a copper tube on the B-drift side to monitor the differential pressure across the seal.

As the ventilation fan speed was increased, the pressures and the air flows through each seal were recorded. Based on data (Stephan 1990a; Greninger et al. 1991) previously collected during the evaluation program with solid-concrete-block and cementitious foam seals, U.S. guidelines for acceptable air-leakage rates through seals were developed for the LLEM seal evaluation programs. The air-leakage rates through the seals during both pre- and post-explosion

leakage tests were evaluated against these established guidelines. Acceptable air-leakage rates are as follows: for pressure differentials up to 0.25 kPa (1-in H₂O), air-leakage through the seal must not exceed 2.8 m³/min (100 cfm). For pressure differentials over 0.75 kPa (3-in H₂O), air leakage must not exceed 7.1 m³/min (250 cfm). The flow rate was calculated from the linear air speed measured by the vane anemometer and the area of the opening through the brattice behind each seal.

The following two sections discuss the construction process and the performance testing of these seals when subjected to a pressure wave produced by a methane and coal dust explosion.

SEAL CONSTRUCTION

Wood Seal Pre-Loaded with Grout Bags

Wood crib type seals are generally used in deeper coal mines that experience excessively high roof and/or floor convergence, which results in premature and, at times, catastrophic failure of more traditional-type seal designs. However, previous LLEM evaluations (Weiss et al. 1993) have determined that wood crib seals cannot withstand a 140 kPa pressure pulse prior to convergence loading on the seal without instituting labor-intensive methods to strengthen the seal design. During LLEM explosion evaluations, the use of pressurized grout bags in conjunction with the use of an easily applied adhesive along the wood crib joints has been effectively demonstrated to provide several advantages when constructing underground coal mine seals. One advantage is the time required for seal construction compared with the standard-type solid-concrete-block seal and other mortared block seal designs. With the construction materials located at the site, it requires approximately 7 hours for two miners to stack and glue the wood cribs, about 1.5 hours to fill the packsetter bags, and about 45 minutes to foam and coat both sides. By comparison, two miners require about 60 to 70 hrs to complete a mortared standard-type concrete block design. Additionally, wood crib seals are near full strength within 24 hr of completion and do not require the 28-day cure period of mortared block seals. This quick construction and cure time is particularly beneficial when installing seals to isolate a fire zone and/or a gob area prone to spontaneous combustion.

The use of hardwood cribbing reduces materials handling requirements, which may further reduce injuries that are typically associated with handling the smaller, yet heavier, standard-type solid-concrete-block. The hardwood cribbing timbers, 15- by 13- by 76-cm (6- by 5- by 30-in long), are commonly used for roof support for many eastern mines. Finally, the wood cribs are dimensionally consistent throughout and allow for easy construction with interlayer glueing.

Figure 2 shows a schematic and figure 3 is a photo of completed wood seal, which was placed in crosscut 1. The 15- by 6-cm (6- by 2.5-in) half timbers were used to overlap the vertical seams. Two 13 mm wide by 76-cm long (0.5-in wide by 30-in long) beads of Handi-Stick adhesive were applied to each timber between rows and two 13-mm wide beads were applied to the vertical sides of each piece. Approximately one 1-L (32-oz) can of Handi-Stick adhesive provided two courses of wood crib coverage. The glue starts to set within 3 min and cures to full strength in 24 hr. During the seal construction at LLEM, the mine temperature dropped to 4 °C (40 °F), making it difficult to keep the glue warm during application. For optimal performance, the glue should be stored and used at temperatures above 10 °C (50 °F).

The packsetter bags, as manufactured by Strata Products Inc. of Marietta, Georgia, were similar in design to the bags used during a previous seal evaluation program (Weiss et al. 2002). The dimensions of the packsetter bags can vary depending on the seal

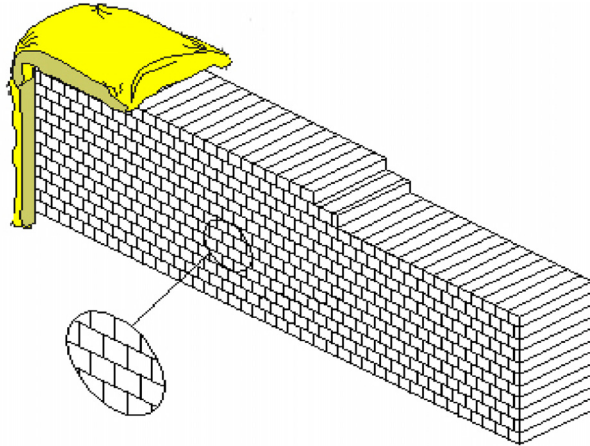

Figure 2- Wood seal design with packsetter bags

design thickness and construction techniques. Twelve 1.2-m by 1.4-m (48 in by 55-in) packsetter bags (working dimensions 1.2 m by 1.2 m) were used along the seal-rib and seal-roof interface to lock the seal into place and to further compress the glued joints. One polyurethane foam pack ('Silent Seal' as manufactured by Fomo Products, Inc. of Norton, Ohio) was used to coat one side of the seal perimeter- ~17 kg (37 lb) per foam pack. The Strata Mine sealant (manufactured by Strata Mine Services, Inc. of Richland, Virginia) consists of a latex-based cementitious product with nylon reinforcement fibers was used to coat the faces of the seal. The sealant is packaged in 19-kg (42-lb) pails and is generally applied by hand; personnel wear protective rubber gloves when applying the sealant. The product manufacturer's recommendation for the use of the Silent Seal foam and Handi-stick adhesive were followed during seal construction.

A modified grout pump powered by the hydraulic take off from the mine's battery scoop was used to facilitate the packsetter bag filling process. As an alternative method for filling the bags where a battery powered scoop or compressed air supply may not be available, the bags can be filled using a hand-pump unit. The packsetter grout is a specially formulated Portland cement- based mixture that is blended and packaged for Strata Products, Inc. by Quickrete in Virginia. One of the key components of the grout is calcium aluminate, which decreases curing times and increases the compressive strengths compared with conventional Portland cements. The compressive strength of the packsetter grout is 2.5 MPa (362 psi) after 24 hr, 3.0 MPa (435 psi) after 7 days, and 4.0 MPa (580 psi) after 28 days. This grout is a high-yield grout which requires significant amounts of water compared to conventional cements. Approximately 55 L (14.5 gal) of water is required per 23-kg (50-lb) bag of packsetter grout. The packsetter bag is designed to contain the entire amount of water with no seepage to meet the maximum specification of 2% free water after the mixing with the grout is complete. The grout is also classified as a non-shrink grout, which specifies a less than 1% shrinkage during the cure period; this is a critical specification required when using the grout in a pre-stressing operation.

In the LLEM test, the packsetter bags were filled with grout to an internal pressure of 350 kPa (50 psi) for the seal in crosscut 1. The packsetter bags along the mine roof were injected first (starting at the center and working toward the ribs) followed by the rib bag closest to the mine floor on each side of the seal. The remaining rib bags were



Figure 3- Pre-loaded wood crib seal

then filled in no particular order. When injected with grout, the packsetter bags overlapped both sides of the wood crib wall a minimum of 8 cm or 3 in.

Upon completion, sealant was applied to selected perimeter areas on both sides of the seal. Foam was used at the interface between the bags and the mine roof to fill any gaps. The mine sealant was then applied by hand to the back side (B drift) of the wood crib seal and then covered with brattice curtain. Several pieces of 2.5 cm by 15 cm (1-in by 6-in.) hardwood boards were nailed over the brattice to the non-explosion side of the wood crib seal. About 30 cm (12 in) of the rib around the perimeter of the brattice was coated with foam; the foam was used to adhere the brattice to the rib/roof/floor perimeter. The front and back of the seal were then sprayed with Strata sealant to cover the brattice/foam interface and any exposed foam (figure 4). A construction time of approximately 12 hr or 60



Figure 4- Coating wood seal with Strata sealant

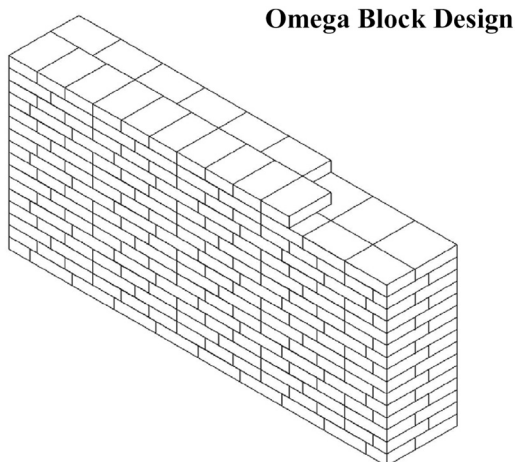

Figure 5- Omega block design

worker-hr was required. Since this was a prototype seal design and modifications to the construction process were required, it is anticipated that the construction time would decrease for future seal installations.

Omega Low Density Block Seal

The ~1-m (40 in) thick Omega block design, schematic shown in figure 5, was 5.8 m wide by 2.1 m high (19 ft wide by 6.8 ft high). Approximately 264 Omega blocks, measuring 20- by 40- by 60-cm (8- by 16- by 24-in), were used with an average block weight of 20.3 kg (44.7 lb). Unlike the previously evaluated Omega block seal designs (Stephan 1990b; Weiss et al. 1993), no pilaster was used and no hitching was required on the ribs and floor with this rapid seal design. The block course was alternated to stagger joints from front to back and left to right (figure 5 and 6). About 26 bags of Quickrete Bloc-bond high-strength fiber mortar was used to fully mortar the joints and as sealant on both sides of the seal. The low viscosity Bloc-bond was applied to all block-to-block interfaces to a mortar joint thickness of about 6 mm (0.25 in). The 6-cm gap between the last course and the mine roof was filled with 2.5-cm by 20 cm long (1-in by 8 in) rough cut boards aligned lengthwise from rib to rib. One row of these boards was placed in the middle of the top seal course with two rows of additional boards placed symmetrically on each side of the center row, with the lengthwise board edges flush with the inby and outby side of the seal. Each row of wood was wedged on about 30-cm (12-in) centers and the gap between the wedges and board rows filled with Bloc-bond. A 0.6-cm (0.25 in) thick coating of Bloc-bond was then applied to both faces of the seal. Seal construction was completed in 9.5 hr and 28.5 worker hours. The Bloc-bond achieves 2000 psi compressive strength within the first 24 hr.

HeiTech Column Bag Pumpable Seal

The HeiTech pumpable bags that were used in this study are primarily used for ground support in longwall mining. They provide improvement in ground support capability as well as reduce material handling. The pumping site for multiple seals can be located in excess of 10,000 ft away and on the surface. For a surface pumping station, a minimum of a 4-in diameter borehole is required to allow 3-cm (1.25in) PVC lines to convey the accelerator and cement slurry. This remote pumping location is especially beneficial when several seals are required and where the handling of material is difficult. The



Figure 6 - Omega seal construction

pumpable bag seal design (figure 7) was constructed by positioning six 76-cm (30-in) diameter cylindrical shaped column bags (with sewn in reinforcement rings or bands spiraling around the circumference of the bags) equally across the crosscut. Each bag was held in place to the mine roof using four PVC adjustable pogo sticks; nylon straps were used to secure the pogo sticks in place during the grout injection process to ensure that the pogo sticks would not bow. These column bags were separated approximately 12 to 15 cm (5 to 6 in) with the end bags approximately 10 cm (4 in) from each rib. No hitching was required with this seal. The material used within each bag was a two-component cementitious grout. Equal quantities of accelerator (90 bags of PacBent 120 Accelerator - M-PB20-Acc) and cement (90 bags of Blue Circle Special Cement Pacset 140 Cementitious - M-PS30-Cem manufactured by Rockfast Mining Products) were used to fill the column bags. The average bag weight for both the accelerator and cement product was 25 kg (55 lb). The bags were grout-injected using a 2.15:1 powder to water ratio; i.e., 100 kg (220 lb) of Accelerator/Cement mix to 212 L (56 gal) of water. A total of 2245 kg (4950 lb) of PacBent accelerator powder and an equal amount of the Pacset cement powder were used with approximately 4770 L (1260 gal) of water. Based on the powder to water ratio used during this construction, HeiTech estimated the compressive strength of the grout to be in the 41 to 55 MPa (600 to 800 psi) range. Subsequent analyses of 6 batch samples showed an average compressive strength of 41.2 ± 4.3 MPa (597 ± 63 psi). Four mixers were used during the grout injection process--two for each powder. An Edeco Mindeb single-action pump was used to inject the grout components into the bags. The pumping distance was approximately 60 m (200 ft). This single-action pump injected ~4 L (1 gal) of the accelerator slurry on the first cycle followed by ~4 L of the cement slurry on the second cycle; these components were then left to mix within the bag.

Each of the 6 bags was initially filled with 30 cm (12in) of grout; this alternating filling process was repeated until each bag was filled to the mine roof. One bag without the reinforcement bands was then inserted between each filled column bag and between the rib and the adjacent column bag; a total of 7 of these bags were required (figure 7 and 8). Tie-wire was spiral-wrapped around two adjacent filled column bags to provide a means of preventing the unfilled bag between from bulging out too much on one side or the other during the grout injection process. The tie-wire was cut and removed before testing. A construction time of approximately 10 hr or 50 worker-hr was required. Since this was a prototype seal design and

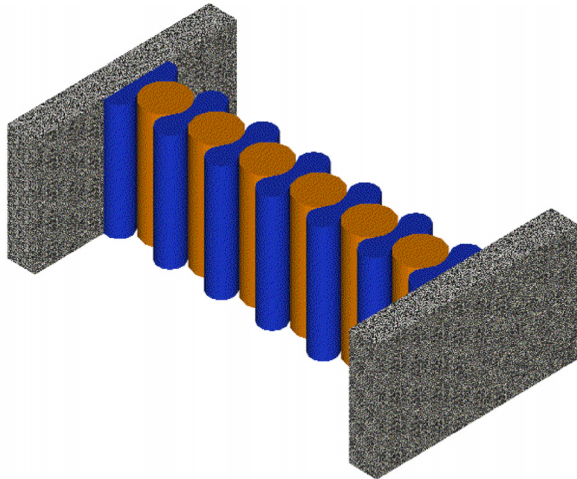

Figure 7 - HeiTech pumpable bag design

modifications to the construction process were required, it is anticipated that the construction time would decrease for future seal installations. The Silent Seal foam was used along the seal perimeter and between the bags on the B-drift side to minimize air leakages.

EXPLOSION AND AIR-LEAKAGE TEST RESULTS

Air leakage rates through the seals during both pre-and post explosion leakage tests were evaluated against guidelines established by MSHA. For pressure differentials up to 0.25 kPa (1-in H₂O), air leakage through the seal must not exceed 2.8 m³/min (100 cfm). For pressure differentials over 0.75 kPa (3-in H₂O), air leakage must not exceed 7.1 m³/min (250 cfm).

The pre-explosion air leakage rates (table 1) through each of the three seal designs were within the acceptable guidelines.

Wood Seal Pre-Loaded with Grout Bags

The pressure and LVDT displacement data measured during the LLEM test #396 on the pre-loaded wood crib seal are shown in figure 9. Within 0.45 sec, the pressure on the seal rose to about 150 kPa (22 psig) and the center of the seal showed a permanent center displacement of ~2 cm (0.75 in). The wood crib seal design with the packsetter bags survived the explosion with no significance evidence of any outward damage. Portions of the perimeter sealant on each side of the seal at the packsetter bag and seal/roof interface were also

Table 1. Air-leakage measurements before the first explosion test

Seal Type	Air-Leakage Rates a, m ³ /min (cfm), at pressure differential, kPa (in H ₂ O) ^a
Wood seal with Pre-Loaded Grout Bags	1.1 (39) at 0.17 (0.7)
Omega Low Density Block Seal	0.3 (10) at 0.25 (1.0)
HeiTech Column Bag Pumpable Sea	1.4 (50) at 0.25 (1.0)

^a Acceptable Guidelines 2.8 m³/min (≤100 cfm) at 0.25 kPa (1.0 in of H₂O).



Figure 8 - Completed HeiTech seal

dislodged during the explosion.

Post-explosion air-leakage measurements showed that this wood crib seal design with the packsetter bags maintained minimal leakages (2.1 m³/min at 0.17 kPa or 73 cfm at 0.7 in H₂O as listed in table 2) well within the acceptable rates; therefore, this design would continue to serve its intended function to limit air movement into and out of a seal area.

The pre-loaded wood crib seal was also subjected to a second slightly stronger explosion (LLEM test #399). Within 0.5 sec, the pressure on the seal rose to about 155 kPa (22.5 psig) and the center of the seal showed an additional displacement of 3.3 cm (1.3 in) for a total displacement of 5 cm (2 in) for both explosions. Following the second explosion, the air-leakage rate across the seal increased to 3.8 m³/min at 0.2 kPa (135 cfm at 0.8 in H₂O); however, the air-leakage guidelines were not applied since this was the second explosion test against the seal.

Omega Low Density Block Seal

The pressure data measured during the LLEM test #404 on the Omega block seal are shown in figure 10. The LVDT failed to function during the test. Within 0.2 sec, the gauge pressure on the seal rose from zero to about 180 kPa (26 psig). Post-explosion observations of the Omega seal revealed little evidence of any outward damage. Post-explosion air-leakage measurements showed that the Omega block design maintained minimal leakages (0.3 m³/min at 0.25 kPa or 12 cfm at 1.0 in H₂O as listed in table 2) and was still well within the acceptable limits for these evaluations.

Table 2. Air-leakage measurements after the explosion.

Seal Type	Air-Leakage Rates a, m ³ /min (cfm), at pressure differential, kPa (in H ₂ O) ^a
Wood seal with Pre-Loaded Grout Bags	2.1 (73) at 0.17 (0.7)
Omega Low Density Block Seal	0.3 (12) at 0.25 (1.0)
HeiTech Column Bag Pumpable Seal	1.5 (53) at 0.25 (1.0)

^a Acceptable Guidelines 2.8 m³/min (≤100 cfm) at 0.25 kPa (1.0 in of H₂O).

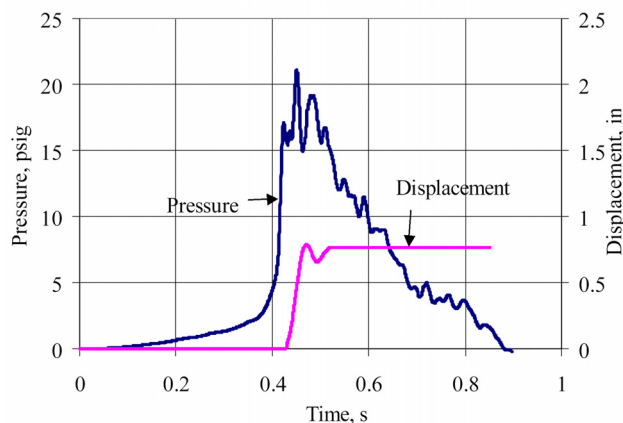

Figure 9 - Pressure and displacement histories recorded on the wood seal

HeiTech Column Bag Pumpable Seal

Figure 11 shows the HeiTech seal pressure loading history and centerline displacement from LLEM test #404. Within about 0.4 sec, the pressure on the seal rose to about 170 kPa (25 psig) and the center of the seal showed a permanent displacement of nearly 4 cm (1.5 in). Even though the seal shifted 4 cm, the post-explosion leakage (1.5 m³/min at 0.25 kPa or 53 cfm at 1.0 in H₂O) remained within acceptable limits.

CONCLUSIONS

This research effort was designed primarily to determine the strength characteristics of the three seal designs for use in rapid sealing operations during a mine emergency or recovery situation. The program objective was to determine the ability of newly constructed seal designs to withstand a pressure pulse of at least 140 kPa (20 psig) while still maintaining significant resistance to air leakage within 24 hours after construction. The wood seal utilizing the quick-setting grout-filled packsetter bags, the Omega low density block seal without hitching, and the HeiTech design with a series of interlocking pumpable grout bags can be constructed in less than 10 hours and all withstood 140 kPa (20 psig) explosion pressure.

These seal designs use existing ground support and stopping materials, require minimum power and compressed air for construction, do not require conventional rib hitching, and, most importantly, can reduce exposure time for coal miners during sealing and mine recovery operations.

ACKNOWLEDGMENTS

The authors thank RAG, American Coal Company in Waynesburg, PA, for providing the seal construction materials and labor for the wood crib seal; Ed Barbour, sales and marketing manager, and Joe Atkins, application technician, of Strata Products, Inc., Marietta, GA, for their contributions to the construction of the seals and the installation of the packsetter bags; Michael Seagal of FOMO Products, Inc., Norton, OH, for providing the Handi-Stick adhesive and glue gun to the project; Charles Lash, technical services representative, of Burrell Mining Products International, Inc., New Kensington, PA, for providing the Omega block and Bloc-bond; Joe Bower, northern region manager, of HeiTech, Morgantown, WV, for

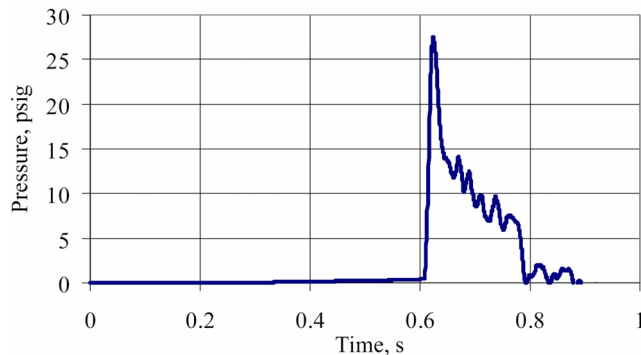

Figure 10- Pressure and displacement histories recorded on the Omega block seal

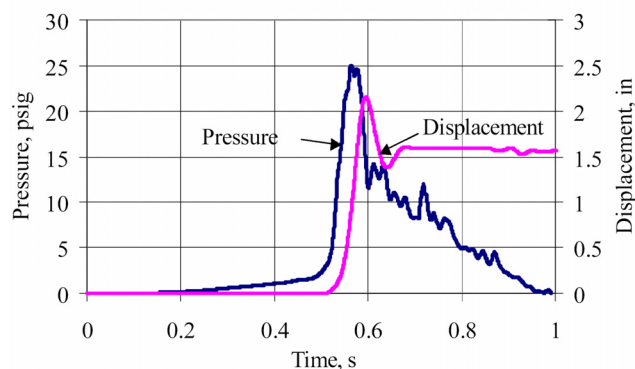

Figure 11- Pressure and displacement histories recorded on the HeiTech seal

providing the seal construction materials and labor required for the pumpable bag seal design.

The authors also thank the following Pittsburgh Research Laboratory personnel who played a key role in the experimental setup, instrumentation, and data collection activities: physical science technicians Cindy A. Hollerich, Frank A. Karnack, Donald D. Sellers, and William A. Slivensky; electronic technicians Kenneth W. Jackson and Richard A. Thomas.

REFERENCES

CFR, 1997, *Code of Federal Regulations*. Washington, DC: U.S. Government Printing Office, Office of the Federal Register.
 Greninger N.B., Weiss E.S., Luzik S.J., Stephan C.R., 1991, Evaluation of solid-block and cementitious foam seals, Pittsburgh, PA: U.S. Department of the Interior, U.S. Bureau of Mines, RI 9382.
 Mattes R.H., Bacho A., Wade L.V., 1983, Lake Lynn Laboratory: construction, physical description, and capability. Pittsburgh, PA: U.S. Department of the Interior, U.S. Bureau of Mines, IC 8911.
 Mitchell D.W., 1971, Explosion-proof bulkheads: present practices. Pittsburgh, PA: U.S. Department of the Interior, U.S. Bureau of Mines, RI 7581.
 Mitchell D.W., 1990, Mine Fires: Prevention, Detection, Fighting. Maclean Hunter Publishing Company, Chicago Illinois, 1990.
 Sapko M.J., Weiss E.S., Watson R.W., 1987, Size scaling of gas

explosions: Bruceton Experimental Mine versus the Lake Lynn Mine. Pittsburgh, PA: U.S. Department of the Interior, U.S. Bureau of Mines, RI 9136.

Stephan C.R., 1990a, Construction of seals in underground coal mines. Pittsburgh, PA: U.S. Department of Labor, Mine Safety and Health Administration, Industrial Safety Division (ISD) Report No. 06-213-90, Aug. 1, 1990.

Stephan C.R., 1990b, Omega 384 block as a seal construction material. Pittsburgh, PA: U.S. Department of Labor, Mine Safety and Health Administration, Industrial Safety Division (ISD) Report No.10-318-90, Nov. 14, 1990.

Triebisch G., Sapko M.J., 1990, Lake Lynn Laboratory: a state-of-the-art mining research facility. In: Proceedings of the International Symposium on Unique Underground Structures. Golden, CO: Colorado School of Mines, Vol. 2, pp. 75-1 to 75-21.

Weiss E.S., Greninger N.B., Stephan C.R., Lipscomb J.R., 1993, Strength characteristics and air-leakage determinations for alternative mine seal designs. Pittsburgh, PA: U.S. Department of the Interior, U.S. Bureau of Mines, RI 9477.

Weiss E.S., Cashdollar K.L. Sapko M.J., 2002, Evaluation of explosion-resistant seals, stoppings, and overcast for ventilation control in underground coal mining. Pittsburgh, PA: U.S. Department of Health and Human Services, Public Health Service, Centers for Disease Control and Prevention, National Institute for Occupational Safety and Health, DHHS (NIOSH) Publication No., RI 9659.