

**COMMUNICATION SYSTEMS RESEARCH AT
BRUCETON SAFETY RESEARCH MINE**

Howard E. Parkinson
Supervisory Electrical Research Engineer
U.S. Bureau of Mines
4800 Forbes Avenue
Pittsburgh, Pennsylvania 15213

ABSTRACT

An environment monitoring and communication system has been installed in the Bruceton Mine, and research is under way to improve mine safety. Standard day-to-day mine communications are available, along with additional systems installed to permit experimentation with wireless radio, through-the-earth phones, along-the-roof paging, and mine face machinery communications.

Research is continuing and the essential concepts for a dependable whole mine communication system, providing simple environment monitoring, improved day-to-day communications and post-disaster communications, will be demonstrated in a larger mine with about 900 feet of overburden.

INTRODUCTION

Some fifty years ago the U.S. Bureau of Mines experimented with seismic and electromagnetic mine communications. The experimentation closed with the thought that electromagnetic communications had promise as a means of communicating through the earth.

During the early- and mid-1940's, the U.S. Bureau of Mines experimented further with electromagnetic communications. The experimentation resulted in the development of trolley wire communications for mine motors.

In 1969 the Federal Government enacted coal mine health and safety legislation. Following the enactment, the Bureau of Mines contracted communications research. An in-house research program was started in 1970. During 1971 the Industrial Hazards and Communications group was formed and mine communications research is now a cooperative effort of universities, private industry, the coal industry, other governmental agencies and the Bureau of Mines.

PRESENT COMMUNICATIONS

The present mine telephone and trolley phone systems (Table 1) provide for vital operational efficiency. The coal industry has recognized this, and has accepted amplified telephone equipment that extends the selective area ring into individual paging and provides communications to the mining section. The industry has also accepted the trolley phone, an ingenious device that aids in expediting rail haulage.

TABLE 1

PRESENT SYSTEMS		
Medium	Typical Equipment	Uses
Telephone Line	Magneto Phone Amplified Phone	Fixed Stations Dispatcher to Mine Sections and Shops
Trolley Wire and Rail	Carrier Phone 88-100kHz	Mobile Dispatcher to Motors
Hoist Ropes	Carrier Phone 88-100kHz	Cage to Hoist Operator
Power Lines	Carrier	Fan Monitor and Circuit Breaker Control

However, mine communications are still plagued by the problems of broken lines due to roof fractionation and the opening of temporary splices, and the problem of not being able to reach the vital operating extremities of the mine. These problems not only affect mine operational efficiency, but inhibit the maintenance of safe operating practices.

COMMUNICATIONS OBJECTIVES

To maintain safe operating practices, general mine communications must encompass post-disaster rescuing, environment monitoring, and day-to-day operating communications as an integrated whole (Figure 1).

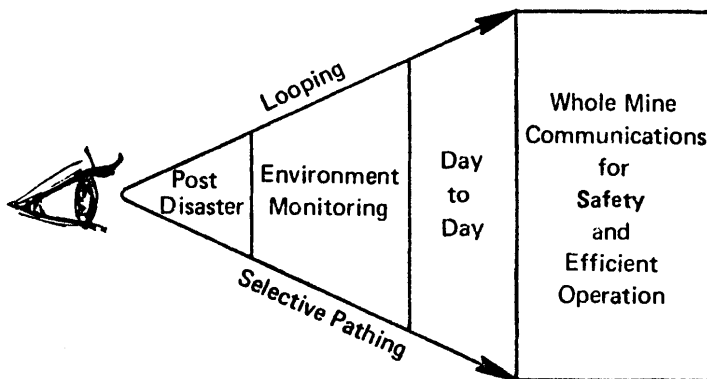

FIGURE 1 A NEW PERCEPTION OF MINE COMMUNICATION SYSTEMS

The day-to-day operating mine communications must help achieve the following objectives:

- To know the working environment is safe
- To assure efficient and safe mine operation
- To provide communication in rescue operations

The Bureau has “fire-truck” type equipment which has been deployed to determine the conditions of the in-mine environment and to provide seismic and electromagnetic communications during rescue operations. The response time limits the effectiveness of the “fire-truck” concept.

Recent post-disaster rescue efforts have brought into focus the simple fact that rescue operations involve more frequently the recovery of bodies rather than the rescuing of miners. *What more beneficial uses can be envisioned for post-disaster communications?*

- First, novel ideas used in post-disaster communications can be integrated into day-to-day operations to overcome the weaknesses of existing day-to-day communications.
- Improved day-to-day mine communications systems can, in turn, provide instant post-disaster communications.
- Finally, environment monitoring from the surface via the mine communications systems can be used to anticipate and prevent disasters.

Having perceived these three potential benefits, the Bureau is evaluating and demonstrating a number of communications concepts for economically providing the desired improved mine communications.

CONCEPTS FOR IMPROVEMENT

Telephone and trolley phone systems are limited. Most phone lines are extended as the mine extends. The longer the phone line, the more difficult it is to reach the last station and the more likely the line will be broken by a small “roof fall” (Figure 2).

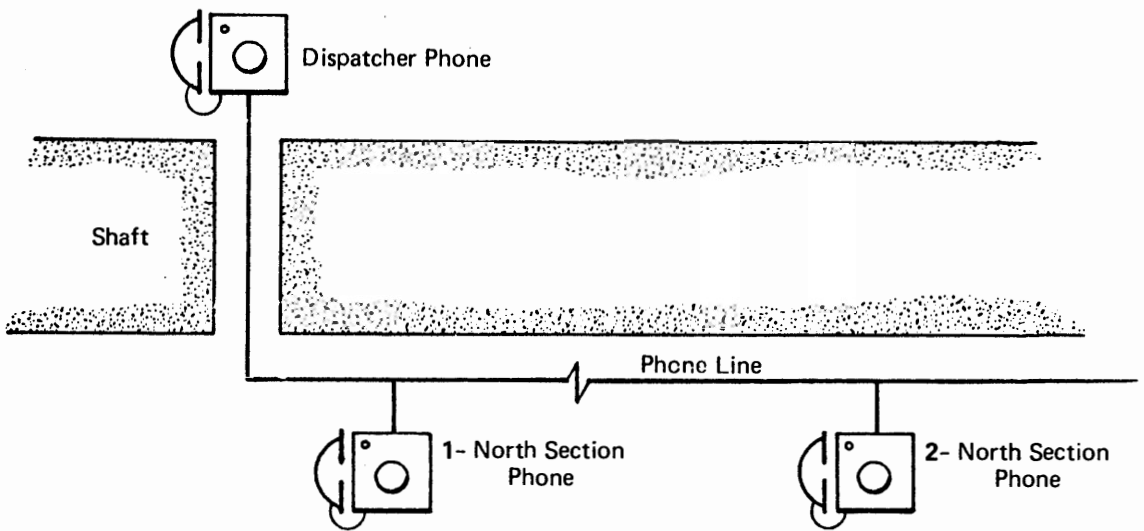

FIGURE 2 EXISTING PHONE SYSTEM

What can be done to improve these systems? Two basic communication system concepts will help, namely looping and selective pathing.

Looping

Systems engineering can plan for an overland return phone line (Figure 3). This phone line will not always be at the "in-most" point of the ever-extending phone line, but it will be a loop back and an alternative line to reach the in-most phones. By returning the telephone line to a surface point, the primary phone line can be monitored.

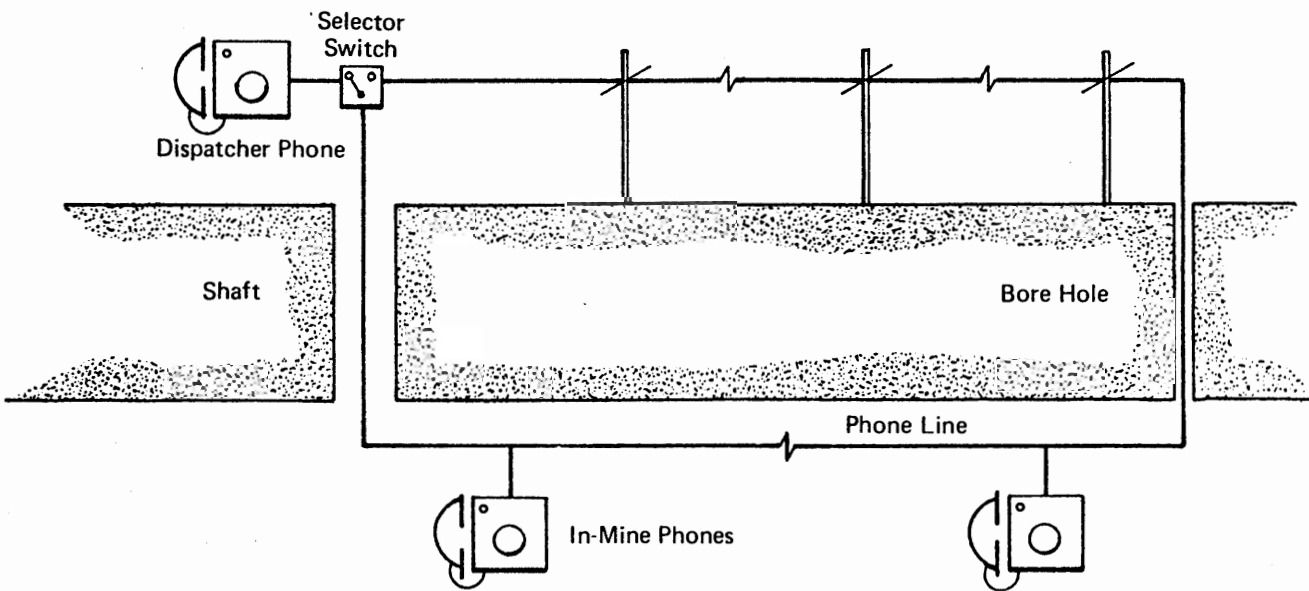

FIGURE 3 LOOPED PHONE SYSTEM

Each message going into the mine also comes out. If the message is not received the surface phone can be switched to the overland line and an effort made to reach the in-most phones. Since signals can be provided to each side of a break in a phone line, communications are not necessarily interrupted by a break in a line.

Selective Pathing

Selective pathing (Figure 4) is a technique that helps make the best out of a difficult situation. Some mines have the trolley phone systems connected to the telephone system. Is this a good idea? Yes and no. Yes, because it provides a means of extending trolley phone range. No, because it interconnects two independent communication systems and results in both being overloaded. A selective pathing connection overcomes the negative, and results in an overall positive conclusion. The selective pathing permits the dispatcher to select a path connection of the trolley phone and telephone. On a "looped" telephone system, the selective connection of the telephone-to-trolley phone also provides an alternative path for the trolley phone to return to the surface. Often a small "roof fall" breaks the phone line, but not the trolley line. Selective pathing provides a possible means to get beyond the phone line break with a signal; also, if the trolley line and phone line break, there is a possible means over the "looped" phone line of reaching the mine motor beyond the break.

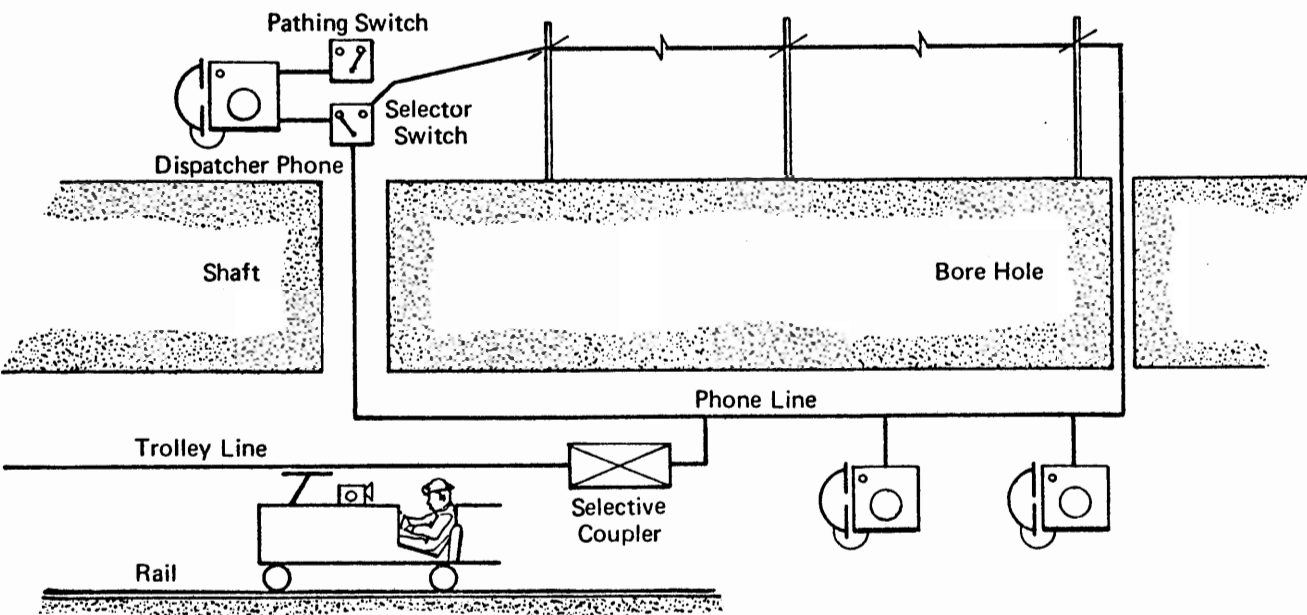

FIGURE 4 SELECTIVE PATHING COUPLER

Looping and selective pathing are things that can be done. *However, other experimental activities also have immediate promise.*

Through-the-Earth Communications

Through-the-earth paging by amplified pager-telephone output (Figure 5) has been demonstrated through 1,700 feet of overburden. Amplified pager output was connected to a grounded dipole through an impedance matching transformer. A galvanic current circulated through the various layers of overburden, and a signal was received on a small ferrite loop of a "manpack" receiver. In another experiment, the signal voltage was taken from two roof bolts, amplified, and placed on the mine telephone line to be received in the telephone handset.

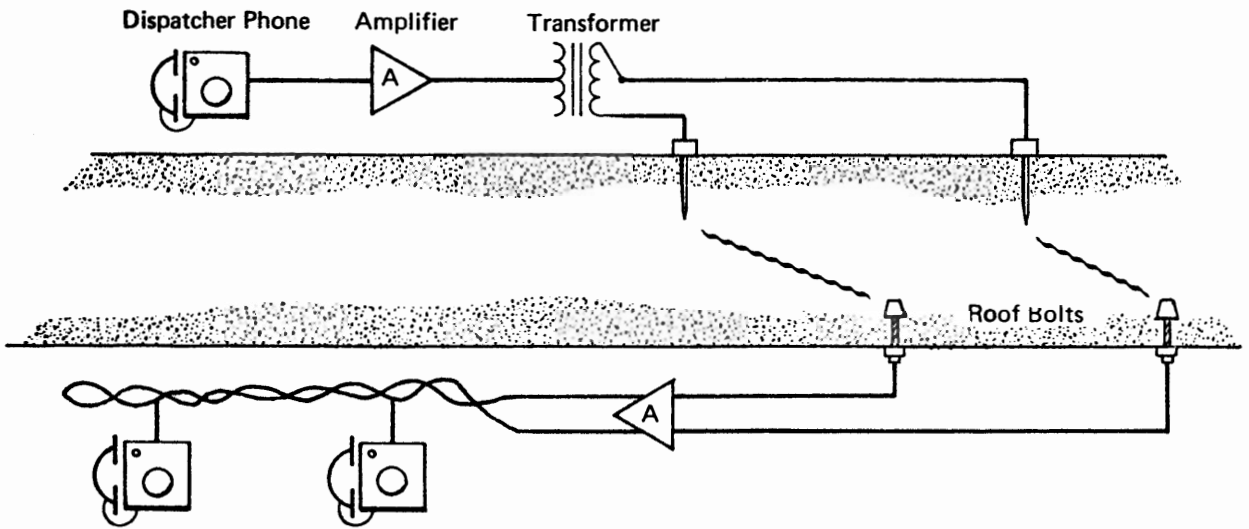

FIGURE 5 THROUGH-THE-EARTH TELEPHONE

The range of coverage is very good. The 10^{-2} mhos/meter typical overburden conductivity of a coal mine allows signals to be received through 1000 ft of overburden when the in-mine pickup and the surface dipole have over 1200 ft of offset.

The trolley phone likewise can be used for through-the-earth communications (Figure 6). A trolley phone unit was modified, separating the transmitter and receiver signal connections. The surface transmitter was connected to two ground rods, and the receiver was connected to a 27db gain amplifier with input connected to a third ground rod. The in-mine unit was similarly modified, and the transmitter was connected to two roof bolts, the receiver amplifier being connected to a third roof bolt. The range was checked out with up to 600 ft of overburden. The system provided two-way voice communications.

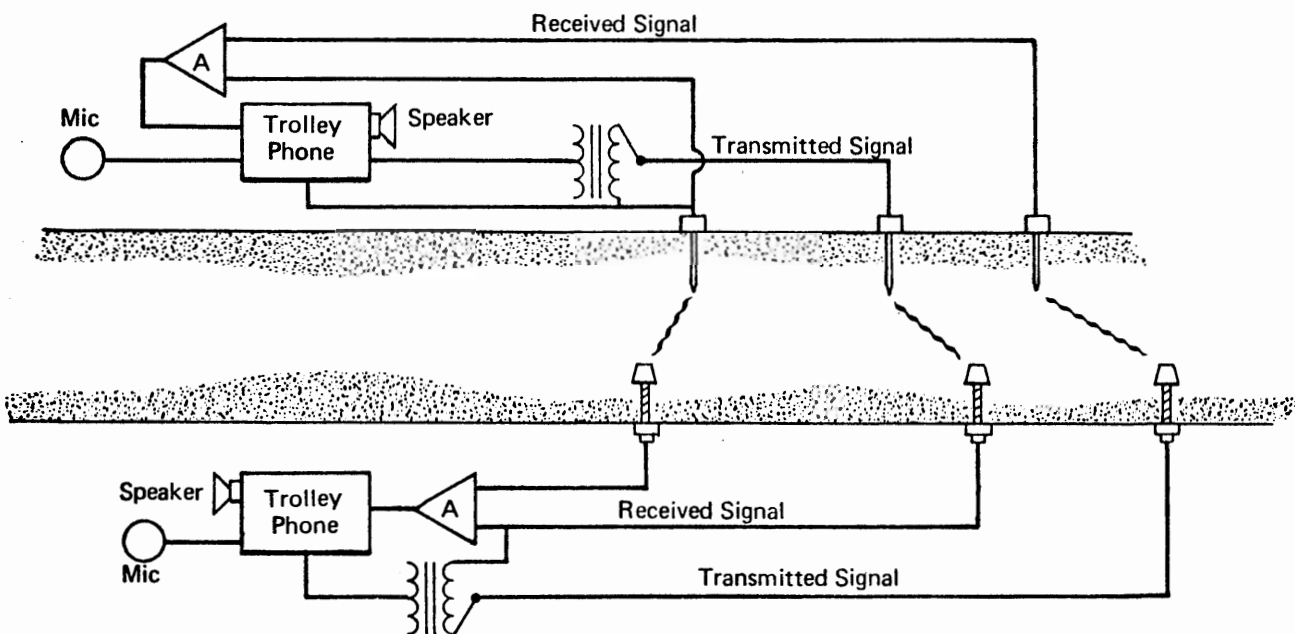

FIGURE 6 THROUGH-THE-EARTH TROLLEY PHONE

Core-Hole Phone

Many mines have exploration core holes. A telephone cable has been inserted in the core hole, and a quick-open enclosure located in the mine houses a standard sound-powered telephone (Figure 7). A junction box with a plug-in receptacle for a sound-powered handset is located on the surface. An explosion evaluation must be made in the Experimental Mine and the system checked for functioning after the explosion.

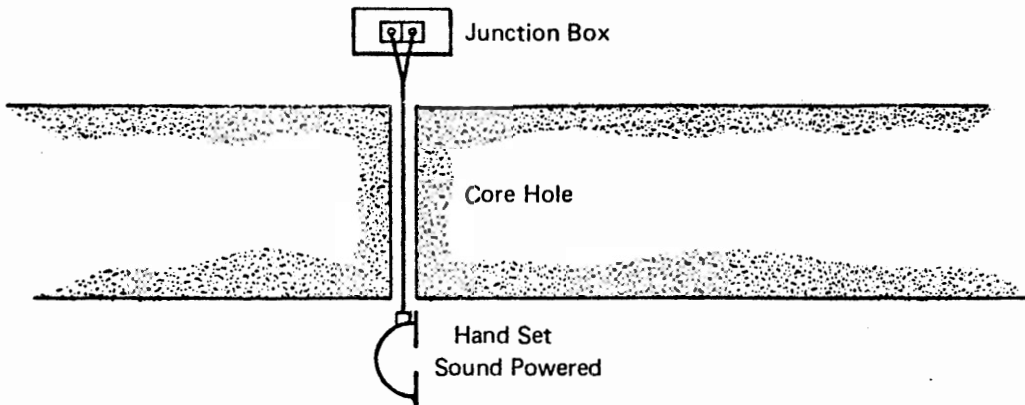

FIGURE 7 CORE HOLE PHONE

Along-the-Roof Paging

How often has a dispatcher paged a section foreman without getting an answer? The operational difficulty arises when the section pager, located near the section loading point, is far removed from the face, and the face area is noisy. In several experiments a standard trolley phone with the signal connected to two roof bolts provided an electromagnetic signal along-the-roof, and the page was received throughout the section (Figure 8). A self-contained pocket pager was modified to receive an 88kHz signal.

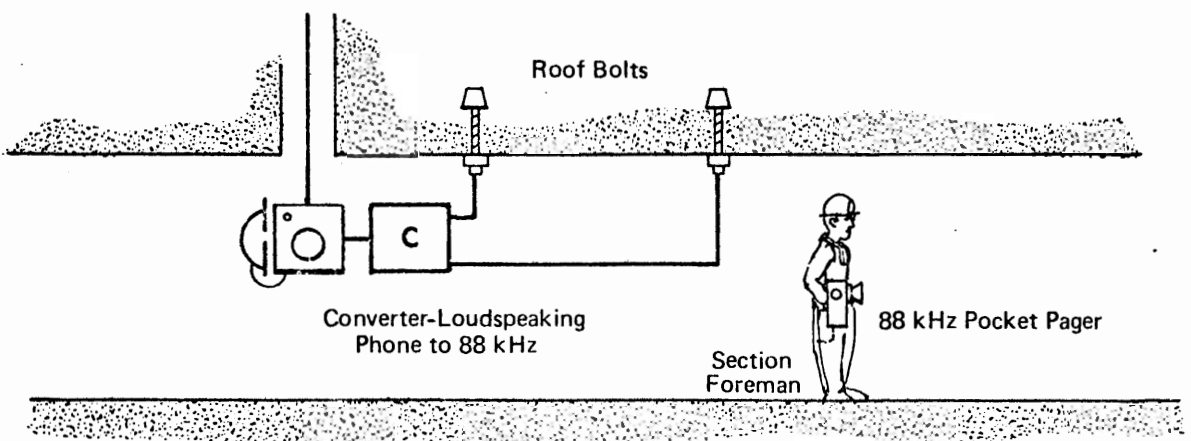

FIGURE 8 ALONG-THE-ROOF PAGING

This idea has been extended into a selective section paging system, allowing for a number of different sections to be paged one at a time by dialing into the mine from the public phone system.

Power Line Methods

Power mains and face trailing cables can also be used: the along-the-roof page signal enters the mine on the ground check wire of the 440V AC power mains (Figure 9). Mine face machinery is powered from trailing cables. Trolley phone devices can be connected to AC or DC lines up to and including a 600 volt line. The trolley phone, powered from a 12 volt battery, was tried on a face machine. Communication was established between the face machine and the surface of the mine.

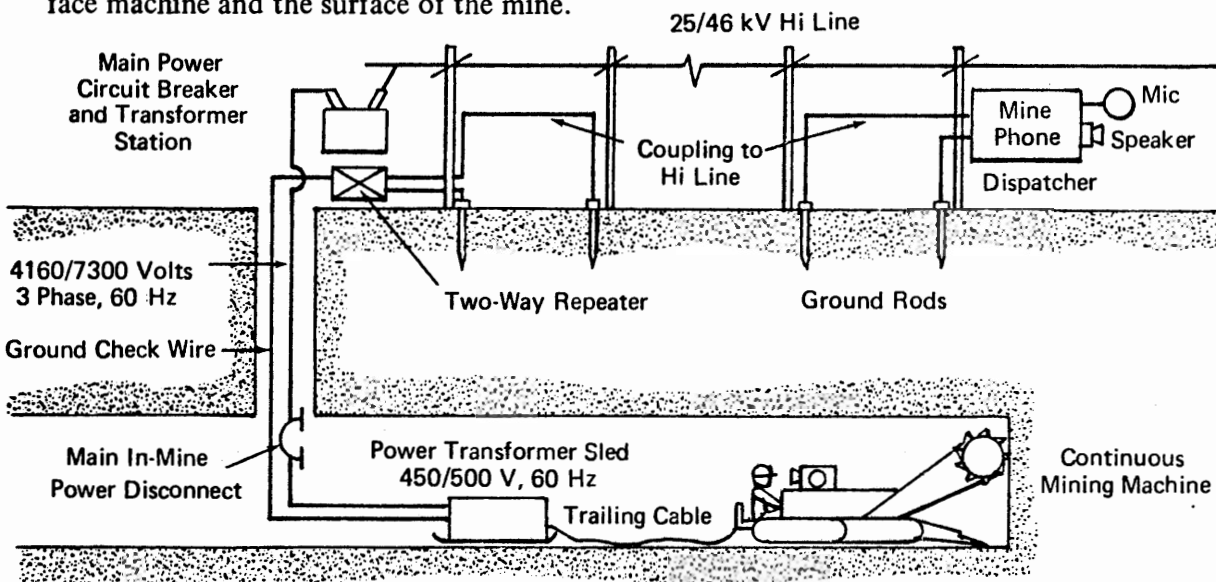

FIGURE 9 POWER MAIN AND FACE MACHINERY TRAILING CABLE METHODS

Though it has not been tested, an AC continuous miner could communicate with a DC shuttle car. Permissibility for 12V equipment is anticipated.

Another project extends the permissible pager to a face machine. Modified trailing cable includes a twisted pair of #18 wires. The section pager line will be connected to the trailing cable phone line. The manufacturer indicates the cable presents no unusual manufacturing problems.

Guided Wireless Radio

Some of the projects indicate that quick returns can be anticipated by adapting selected ideas into day-to-day mine communication systems. Others require a completely new mine communication system. During the Sunshine Mine post-disaster rescue operation, 465MHz wireless radio was used (Figure 10). The signal was guided by a small gauge insulated wire dropped on the mine floor. Non-line-of-sight communications were established at a distance of 2,300 feet between two portable units, and with one portable over

300 feet from the wire. Extensive experimenting is being done with guided wireless radio.

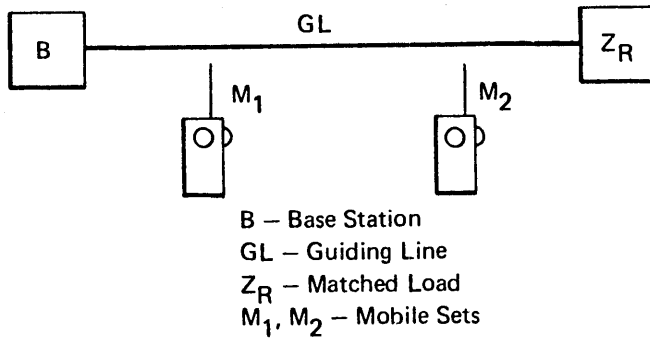

FIGURE 10 GUIDED WIRELESS RADIO

The experimenting is not yet conclusive as to the desired frequency or type of guide. Three frequency ranges, 27mHz, 170mHz, and 406mHz to 460mHz have been tried. Studies also indicate that even higher or lower frequencies might have advantages. The guides we are experimenting with are a simple insulated wire terminated to a roof bolt connection, an inexpensive coaxial cable terminated in 70 ohms, a special heliax cable, and a specially designed quasi-antenna spaced throughout the length of a coaxial line. Our experiments have resulted in the development of a special in-mine repeater that greatly extends the range of the base station to the portables. The guided wireless radio system can provide communications between surface and motor, surface and section, and between two roving miners. A surface radio loop-back has also been established by an overland 406mHz radio link. By multiplexing, all in-mine monitoring, pager, trolley phone, and wireless radio signals are being looped back to the mine foreman's office.

Some essential benefits and costs of the phone systems discussed are summarized in Table 2.

TABLE 2
SYSTEM CONCEPT EVALUATION

System	Relative Cost		Function				Effectiveness			
	Equipment	Line	Fixed to Fixed	Fixed to Motor	Motor to Motor	Between Roving Miners	Through the Earth	Along the Roof	Guided	Hard Wired
Telephone	■	●	Yes	No	No	No	Good	OK	Not Good	Very Good
Trolley Phone	■ ■ ■	○	Yes	Yes	Yes	No	OK	Good	OK	Good
Radio Phone	■ ■ ■ ■	○ to ● ● ● ● ●	Yes	Yes	Yes	Yes	Not Good	Not Good	Good	Not Good

- = 1 Unit of Equipment Cost
- = 1 Unit of Line Cost
- No Cost

BRUCETON INSTALLATIONS

The communications systems installed in the Bruceton Safety Research Mine are aimed at developing an emergency communication system, based on available technology, that is a practical extension and modification of existing general-purpose mine communications equipment. Table 3 is a list of some of the sub-systems operating or being installed at this time.

TABLE 3

SUB-SYSTEMS-BRUCETON SAFETY RESEARCH MINE-OPERATING OR BEING INSTALLED

- Mine Monitoring – 10 Major Locations
- Mine Paging Telephones – Main Operating Points
- Monitor-Trapped Miner Locator – Communicator Station – 3 Fixed Locations
- Soundpowered Telephones – Explosion Test Area
- Telephone Through-the-Earth Paging – Throughout Mine
- Power Cable Telephone – Face Machine
- Public Phone System Tie to Mine Paging Telephones – Telephone Building
- Battery Operated Motor – Haulage Communications
- Trolley Phone Along-Roof Paging – Working Section
- Pilot-Wire Power Cable Trolley Phone – Face Machine
- Through-Earth Trolley Phone – Fixed Rescue Point
- Overland Power Line Carrier – Office to Mine Section Borehole
- Loop Back on Power Line Carrier
 - Haulage Communications
- Wireless Radio – Main Operating Areas
- Overland Radio – Foreman's Office to Mine Section Borehole
- Loop Back on Overland Radio
 - Haulage Communications
 - Mine Paging Telephone
 - Wireless Radio
 - Mine Monitoring

The Mine (Figure 11) is a gathering point of a variety of systems for the purpose of evaluating and demonstrating the preceding concepts. The concepts are implemented with the goal of providing system configurations that will permit instant communications during an emergency, together with providing both operational communications and continuous monitoring of the underground environment. The basic systems-engineering details of the Bureau of Mines experimental work will be covered in future articles. Details of environment monitoring and other communication concepts will be given by several participants in this conference.