

An Overview of Geomechanics Safety Research On Mobile Roof Supports

Hamid Maleki; Maleki Technologies, Inc.; Spokane, WA

John Owens and Wayne Howie
Spokane Research Laboratory, National Institute for Occupational Safety and Health; Spokane, WA

Keywords: Mobile roof supports, load rate monitoring,

Abstract

After an analysis of the hazards of room-and-pillar retreat mining systems, it became apparent that safety could be significantly improved by considerations of (1) human factors, (2) remotely controlled mobile roof supports (MRSs), (3) mine layout designs, and (4) ground monitoring systems. Initial studies of the effectiveness of MRSs focused on their interaction with mine strata and evaluations of suitable measurements for detecting roof stability problems during pillar extraction. These studies indicated that overall stress distributions and strata movement were most influenced by the stiffness of coal-measure rocks and the design of mining layouts. Thus, to improve worker safety, mine layouts should be carefully designed and a pillar extraction method chosen for specific geologic and stress conditions.

Pillar failure was often associated with an increase in pressure on the hydraulic gauges of the MRS, and roof failure was often preceded by rapid changes in the rate of roof-floor convergence. These studies led to development of a monitoring system that displays loading rate on an MRS in real time. A major MRS manufacturer cooperated in installing and testing the system on an MRS. New field studies focus on evaluating the performance of the system, measuring roof-floor convergence, and optimizing the safety of MRS operations through proper mine layout design.

Introduction

Room-and-pillar mining is one of the oldest methods used for the extraction of tabular ore bodies. In this method, a series of rooms are driven on advance using continuous miners and shuttle cars while the roof is bolted a short distance behind the face. During the retreat, the same equipment is used to mine the pillars, which allows roof rocks to cave behind the face. To control the cave line, a series of secondary support systems are installed as mining continues within the pillars.

The room-and-pillar mining method is at a disadvantage when compared to other mining techniques, such as longwall mining. Because of economies of scale, the productivity of room-and-pillar mining is significantly lower. The longwall method is also much safer because the retreat is completed under the protection of self-advancing hydraulic support systems at the face. However, during the last two decades, federal laboratories, mining companies, equipment manufacturers, and geomechanics consultants have cooperated to improve the understanding of strata mechanics and develop a remotely controlled, self-advancing support system called a mobile roof support (MRS). This cooperation has resulted in improvements in the safety and productivity of room-and-pillar retreat operations.

Figures 1 and 2 illustrate generic panel layouts and pillar extraction sequences for two typical room-and-pillar retreat systems. The first is three-entry access and retreat to one side, while the second is nine-entry access with full retreat within the panel.

In the first system, mining starts by driving a three-entry panel access to the boundaries of the room-and-pillar panels. A three-entry system using narrow rib pillars is developed to the side and retreated. After pulling one row of pillars, another row is driven into the solid coal block, and the sequence is repeated until the panel coal is extracted. Pillar recovery operations consist of splitting the pillars and fenders. Figure 1A presents the mine layout at four stages of pillar recovery. Figure 1B shows the sequence of the pillar cuts, typical position of posts, and the location of unmined stumps for the extraction of a pillar using the split-and-fender method.

In the second system, a nine-entry access is developed on advance to panel boundaries. The pillars are then extracted until the entire panel is mined. Figure 2A presents the panel layout and the location of MRSs at three intermediate stages of pillar recovery using the Christmas tree® method. Figure 2A also shows the sequence of cuts taken

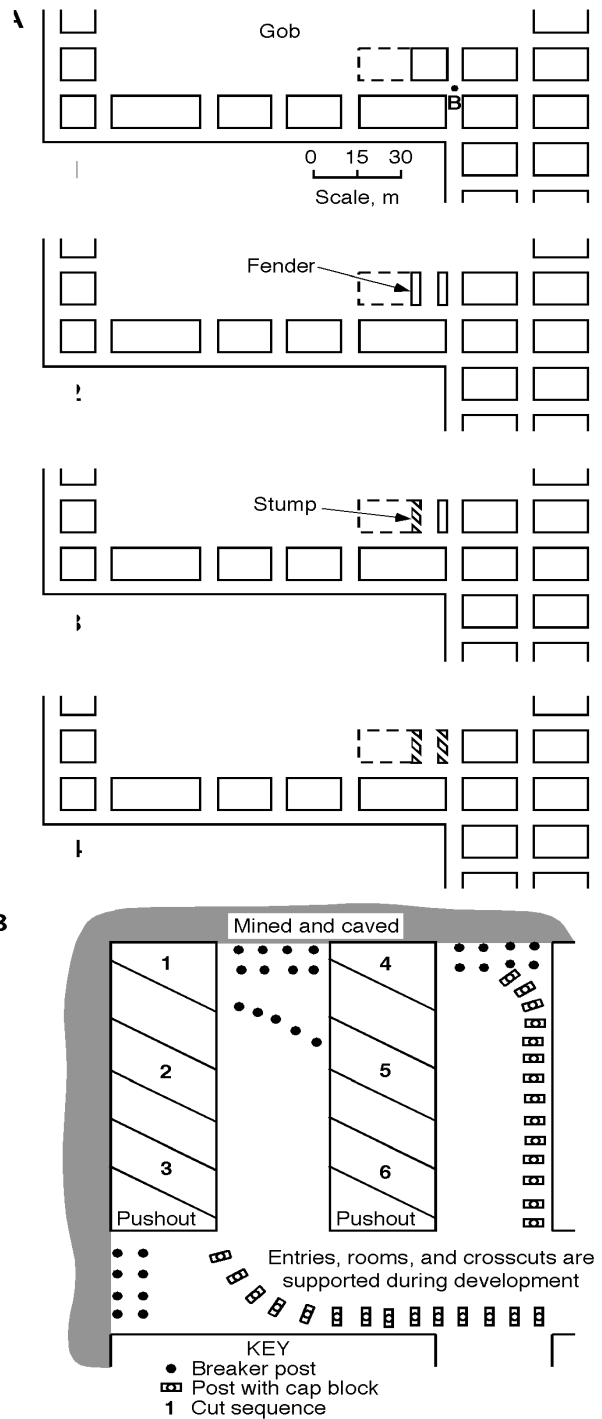

Figure 1. Mine layout (A) and pillar extraction sequence (B) using split-and-fender method with posts.

from two pillars where MRS-s are used as secondary support. Many variations of these two panel layouts and excavation sequences are practiced in U.S. coal mines. New applications of the three-entry system involve use of MRS-s instead of posts and eliminates fenders completely.

After completing an analysis of the hazards of room-and-pillar retreat mining systems, it became apparent to the authors that safety could be significantly improved by considerations of (1) human factors, (2) remotely controlled MRS-s, (3) mine layout designs, and (4) ground monitoring systems. A significant effort was directed to studying the above factors both in the laboratory and in the field.

Human Factors

Several human factors considerations were identified during a geomechanics field study (Maleki 1981) in which the main objective was to identify causes of roof stability problems and develop practical monitoring techniques for detecting these problems (Maleki and McVey 1988). These factors were (1) the number of people required at the face, (2) the amount of time required to work at the cave line, (3) poor footing in entries, which influenced timely escape during a roof fall, (4) worker reaction at the time of a roof fall, and (5) the judgment-based methods used by miners to evaluate the stability of the roof and determine the optimum time for retrieving miners and equipment.

A large crew is required for conventional room-and-pillar retreat operations because posts must be delivered, cut to size, and installed. Each installation takes approximately 20 min and requires two to three workers. Debris on a mine floor can accumulate quickly and create poor footing. Miners must judge roof stability continually on the basis of observations of primary and secondary support behavior (bending of roof plates, crushing of posts, etc.). In the study mine, when the roof caved prematurely and trapped a miner in a cab, other miners rushed to help. A second rock fall could have resulted in serious injury to rescuers (Maleki 1981). This could have easily happened, considering that many posts had already been broken and some had been knocked down during the first fall.

Development and Testing of the MRS

To improve the safety of room-and-pillar retreat systems, a two-step solution was proposed. First, the mechanics of strata behavior were studied through extensive field measurements, and practical techniques for assessing roof behavior were developed. Second, a prototype of a remotely controlled roof support system was developed to eliminate the need to install posts near the gob. The machine was equipped with a dozer blade so that floor debris could be cleaned routinely, which allowed easier travel and escape. The prototype unit was developed by the U.S. Bureau of Mines in cooperation with an equipment manufacturer and a mining company (Thompson and Frederick 1986).

Commercial units have since been developed by U.S. and Austrian manufacturers and are being used on two continents. The commercial MRS units are more rugged and have higher capacities (5,340 to 7,120 kN [600 to 800 tons]) (Wilson 1991; Howe 1998) than the prototype. They consist of a roof canopy, four hydraulic cylinders, a caving shield canopy, and associated electro-mechanical systems

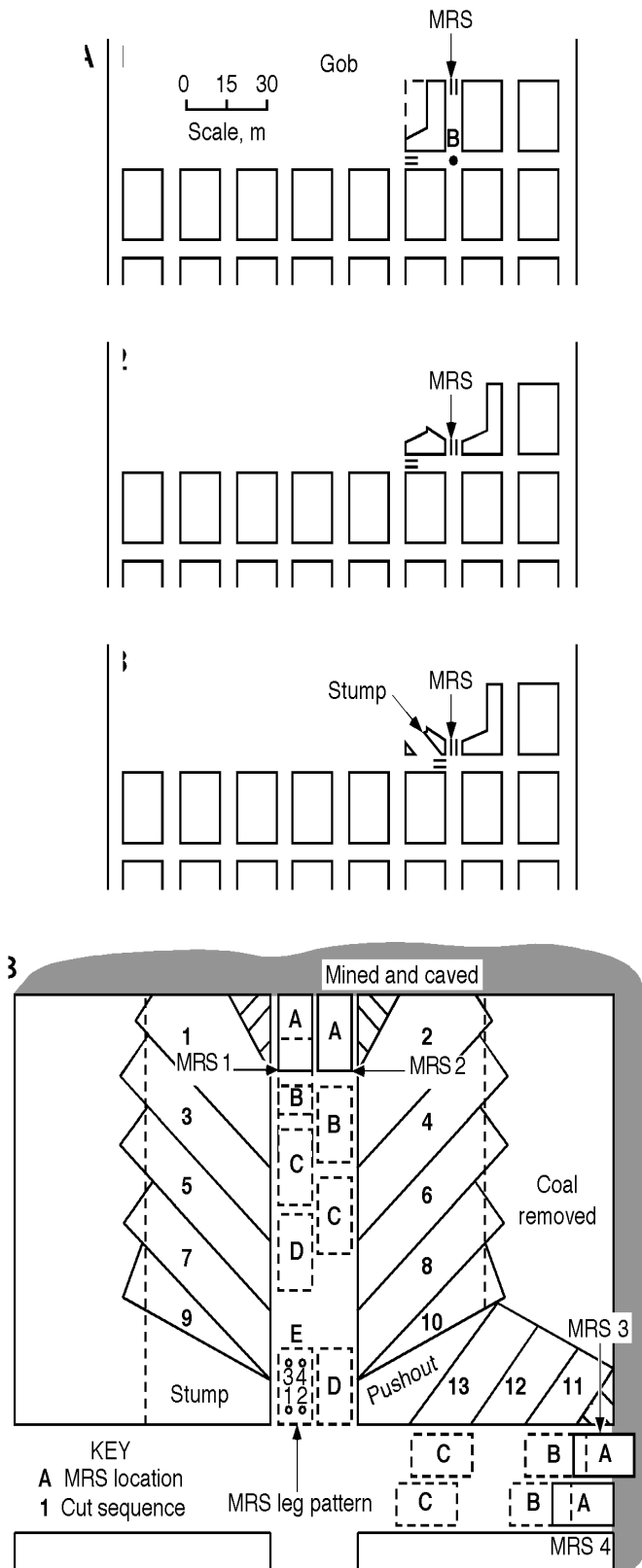

Figure 2. Mine layout (A) and pillar extraction sequence (B) using Christmas tree method with MRS's as support.

mounted on crawler tracks. The system has radio control and self-contained power units. Because of their greater mobility and because they allow higher resource recovery, they are currently being used in 36 U.S. coal mines, as well as a number of Australian mines (Shepard and Lewandowski 1992; Habenicht 1988).

MRS performance has been monitored both in the laboratory and in the field by NIOSH personnel. Laboratory investigations focused on an evaluation of support stiffness and load-carrying capacity under controlled static loading conditions. The study quantified system stiffness as a function of machine height for both two- and three-stage hydraulic cylinders (Barczak and Gearhart 1997, 1998). Three-stage cylinders are needed in thick seams, but reduce support stiffness. Each unit has the load-bearing capacity of six posts and the stiffness of two hardwood posts (Barczak and Gearhart 1997). The study also identified inaccuracies in hydraulic cylinder pressure measurements of roof loads when the bottom cylinder stages were fully extended.

The mechanics of load transfer from pairs of MRS-s to mine strata were analyzed using laboratory results, boundary-element modeling, and analytical solutions. The results showed that MRS-s support roof rocks near the machines, but do not have the capacity to control overall roof-floor convergence and overall stress distributions because the MRS-s are considerably less stiff than coal-measure rocks. In comparison to posts, however, an MRS is capable of maintaining the yield load after significant amounts of roof-floor deformation. Because the mining cycle is accelerated, MRS-s help reduce the potential for time-dependent roof falls.

To study the influence of pairs of MRS-s on the mine roof, the authors used analytical solutions for two pairs of MRS-s positioned 5.5 m (18 ft) apart (figure 3) (Maleki and Owens 1998). Results showed that MRS-s form a pressure arch in the immediate roof that reduces the potential for roof falls in the space confined by the MRS-s. This is beneficial for protecting a continuous miner when it is operating within this space. It was also found that higher MRS capacities and setting pressures are useful for stabilizing the upper strata, but may contribute to differential loading on the immediate roof, failure of mechanical bolts, and reduction in the stability of the immediate roof.

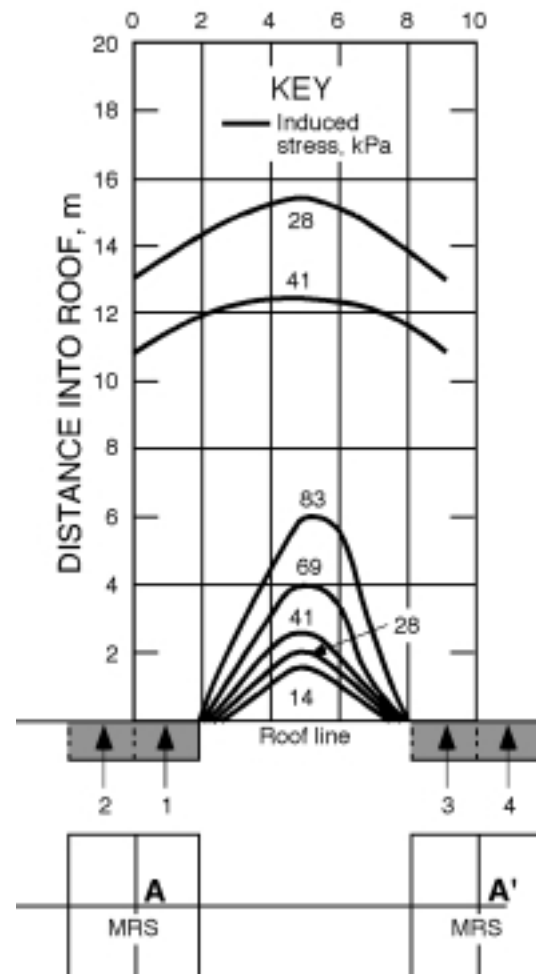

Figure 3. Stress isobars along A-A' for two pairs of MRS's at 5.5-m spacings.

Early field evaluations focused on a comparison of ground movements in two room-and-pillar retreat sections using the split-and-fender method with posts (figure 1), and the Christmas tree method with MRS-s as the secondary support system (figure 2). In addition, the history of hydraulic pressure was analyzed for all four MRS legs (Hay and others 1995). Deformation measurements indicated generally higher strata movement at the intersections in the section using the Christmas tree method. Because of differences in geologic conditions and mining practices, it was not possible to make a direct comparison. We recommended that numerical modeling of these geometries address mine layout designs while keeping geologic conditions constant.

Panel Layout Design

Field studies identified the importance of mine layout designs and revealed the dangers of overconfidence concerning the ability of MRS-s to support the entire area. Such overconfidence contributed to workers choosing unsafe operating locations. Thus it became apparent to the authors that to improve stability, layout designs that control convergence and stress should be developed. To illustrate this point, boundary-element analyses were completed in which stress distributions were calculated in both single and multiple seams. These analyses were also helpful in tailoring the type of monitoring required to assess changes in the stability of the mining system.

The first study compared stress distribution and convergence patterns for two pillar recovery plans: split-and-fender and Christmas tree. Model input was based on extensive laboratory and field measurements in one mine (Maleki 1981), and modeling procedures were based on a methodology developed for coal mine excavations (Maleki 1990; Maleki and Owens 1998). The analyses were completed for a typical depth of 305 m (1,000 ft).

Figure 4 presents the calculated roof-floor convergence for a point in the intersection for two pillar recovery methods (point B in figures 1A and 2A) and provides guidance for selecting monitoring systems. Note that calculated deformation significantly increases within a mining step, which is associated with the failure of fenders and stumps. MRS-s will therefore experience an increase in both vertical and lateral support loading as fenders fail. Since fender failure induces differential movement in the mine roof, a roof fall may be triggered. Such a roof fall may be sensed through monitoring either convergence rate or possibly MRS leg pressures. The change in convergence that occurs as a result of failure of the fenders is large enough to cause a change in leg pressure. Other changes in convergence rate, however, may best be detected by monitoring roof-floor convergence in view of the insensitivity of leg pressure to roof loads if the bottom stages are fully extended. Roof-floor convergence is at least 10% higher using the Christmas tree method, as illustrated in figure 4. To control convergence, a stump (figure 2) left in the model (no pushout). Further improvements in stability and convergence can be achieved by changing the size of the stumps and pillars left behind.

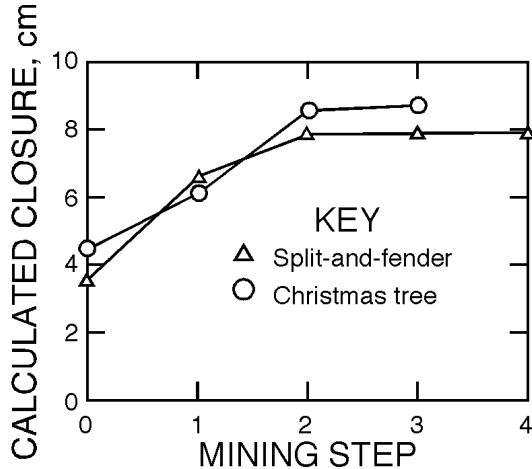

Figure 4. Calculated closure for split-and-fender and Christmas tree methods at location B.

MRS-s are used often when mining difficult reserves, such as where there are earlier workings in adjacent seams. To assist a mine operator with design of an MRS layout in a two-seam reserve, the authors completed a multistep analysis. The stress distribution was calculated for an MRS section recently placed in a bed (No. 2) 12 m (40 ft) below a partially mined seam (No. 1). Model input was based on extensive measurements at the mine (Maleki 1988a). Overburden averaged 360 m (1,200 ft) over the entire modeled area.

Figures 5 and 6 present mining geometry and vertical stress distribution for both seams. Step 1 included longwall mining in the southern portion of the reserve and simultaneous room-and-pillar mining with partial retreat in the northern part of seam 1 directly above the areas of interest. Step 2 consisted of limited development work in seam 2.

Results from step 1 (figure 5) show the stress distribution for both the longwall and room-and-pillar panels. Stresses are elevated near the edge of the caved areas because of the low stiffness of the caved rocks. This change in stress pattern influenced load transfer to the lower seam and thus should be considered in development of layouts below.

Results from step 2 (figure 6) clearly demonstrate load transfer (stress footprint) to bed 2 because of mining in the top seam (note that the only mining that had occurred in bed 2 was a small amount of pillar development, as shown toward the right boundary of the model). Stresses were lower under

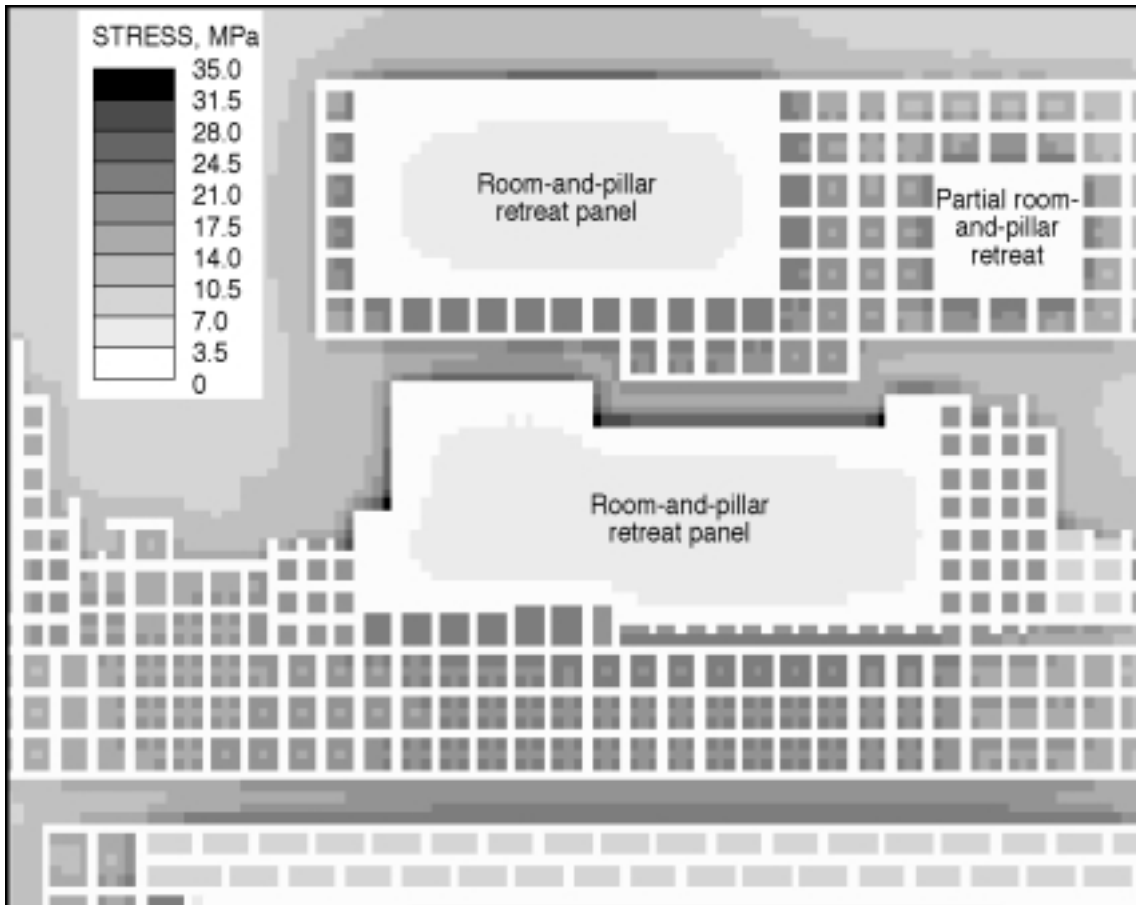

Figure 5. Vertical stress distribution for upper seam 1, step 1.

the gob and higher near the periphery of the full-extraction areas. Results were used to define the optimum location for room-and-pillar layouts in bed 2 for pillar extraction using MRS-s.

Development and Testing of Ground Monitoring Systems

During field tests in underground mines, the authors identified three factors that might adversely influence worker safety in an MRS section.

- \$ Elimination of posts reduced a worker-s ability to assess roof conditions.
- \$ Overconfidence in the ability of MRS-s to support the entire area caused some miners to chose unsafe operating positions.
- \$ Use of MRS-s on a routine basis under adverse geologic and mining conditions to recover reserves that were otherwise unminable. It became apparent to the authors that there was a need to develop a warning system that would alert workers to unstable roof conditions so that

miners and equipment could be moved before a fall occurs.

Two monitoring methods were chosen on the basis of mine measurements and numerical modeling considerations. These were roof-floor convergence and load-rate monitoring on the hydraulic legs of MRS-s. Convergence pins can be placed over the entire area of interest to monitor the stability of the whole section (Maleki 1988b). Monitoring the rate of load on MRS legs also is believed to provide warnings about major events, such as failures of fenders and pillars. These events generally trigger roof falls. A reliable warning system can be developed by combining both convergence and load-rate data.

Convergence measurements were obtained from four mines that use different primary and secondary support systems under variable amounts of cover (90 to 360 m [300 to 1,200 ft]) and both flat-lying and dipping seams (0° to 8°). Figure 7 presents measured total convergence showing that roof



Figure 6. Vertical stress distribution for lower seam 2, step 2.

falls occurred generally after 2.5 cm (1 in) of convergence (and occasionally up to 50 cm [20 in]). Total convergence by itself is not a suitable indicator of roof stability.

Rate of convergence is a reliable measure of roof stability (figure 8). Note that there were no roof falls where the convergence rate was lower than 0.5 cm/min (0.2 in/min). Minor falls were recorded at a convergence rate of 0.5 to 0.65 cm/min (0.2 to 0.25 in/min). Critical rates exceeding 0.65 cm/min (0.25 in/min) were measured prior to roof falls in all four study mines. Results are very encouraging, although site-specific convergence measurements should be taken in any new mine to verify this critical rate.

Research continues to refine monitoring and data acquisition systems, as well as define critical rates that indicate a change in the stability of the system.

A prototype load-rate monitoring device has been developed for the MRS-s. The device monitors pressure in the hydraulic cylinders of the MRS dy-

namically, calculates changes in pressure over time, and converts pressure changes to loading rates. Warning lights can then be activated, depending on the rate of change. Field tests of the load rate concept will complete identification of critical rates of load that indicate imminent roof falls.

Load Rate Monitoring System on MRS-s

Hydraulic supports such as the MRS provide little or no discernible audible or visual indications of impending roof caving. In MRS retreat mining sections, miners rely on the hydraulic gauges on the MRS-s to determine when to cease operations and leave the area of the active mining face before a roof fall. A imminent roof failure is often preceded by a rapid increase in pressure on the dial gauges. However, these gauges are difficult to read, requiring the miners to approach the MRS-s to monitor the gauges. This requires them to be close to the active mining face, an area susceptible to roof falls, and in a location with a lot of equipment

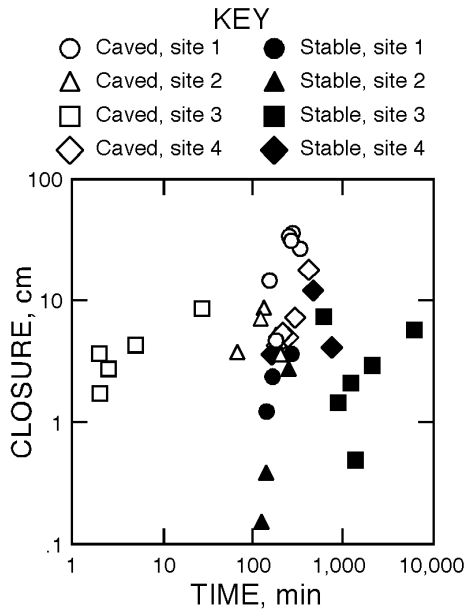

Figure 7. total measured roof-floor convergence prior to roof falls at four mines.

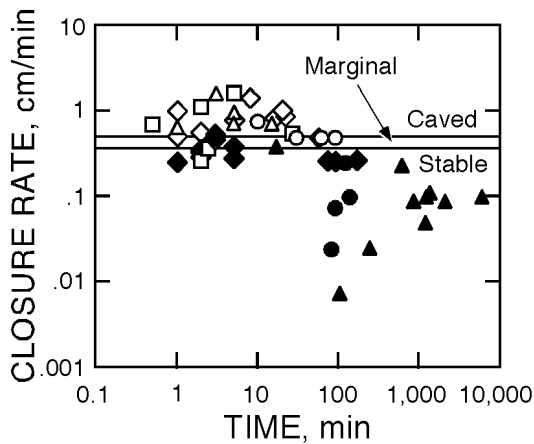

Figure 8. Roof-floor convergence rates prior to roof falls at four mines. Key is same as for figure 7.

activity. As a result, miners do not check the pressure gauges often. A load rate monitoring system was developed that monitors and displays dynamic loading rates on an MRS in real time to alert miners to dangerous loading conditions during pillar extraction. The system can easily be seen by all miners in the vicinity of the MRSs.

Figure 9 is a schematic diagram of the load rate monitoring system. The system monitors the two hydraulic systems with standard analogue pressure transducers at 0 to 34.5 MPa (5,000 psi). This pressure is translated to an analog voltage of 0 to 5

V dc. An analogue-to-digital converter then transforms each voltage to a 12-bit (0 to 4096 level) digital value that is input to a dedicated Micro-485 programmable controller for processing. The controller is based on a highly integrated version of the world standard 8051 microcontroller family. It calculates loading rates in Assembly, Basic, and C languages and controls output signals to the three load-rate indicator lamps. A socketed 80C51FA CPU is ideally suited to the control and data acquisition requirements of the system.

Loading is proportional to internal pressure and surface area of the piston head of hydraulic cylinder and is determined by the formula

$$F = A \times P,$$

where F = force (N), A = area (cm^2), and P = pressure (MPa). The embedded processor reads changes in cylinder pressure through two multiplexed data acquisition channels of the load rate monitoring controller. These pressure changes are converted to loading rates that activate different colored lights as the loading rate increases on the MRS. Green indicates that there is minimal change in load rate on the MRS, yellow indicates that the load rate is increasing and that additional caution is recommended, and red indicates a rapid load rate increase and that a roof fall may occur soon. A continuously flashing red light indicates that the hydraulic cylinder load is approaching the yield of the MRS, and that the unit may soon collapse. Alternative load rate indicator devices (multicolor strobes, LEDs, and audible alarms) can be used with the system to meet specific warning requirements as requested by mine operators or MRS manufacturers.

The system will operate as an integral part of the MRS and will not require on-site maintenance. Necessary calibration can be done prior to installation or periodically as mine conditions change, but need not be done by operating personnel at the mine. The operating parameters for the system are set by connecting the system to a laptop computer via an RS-232 null modem cable with the communication terminal emulator acting as the laptop client program. This allows a trained user to easily change the parameters for triggering the various load rate indicator devices to suit conditions at the mine. The load rate monitoring system is designed to be MSHA permissible.

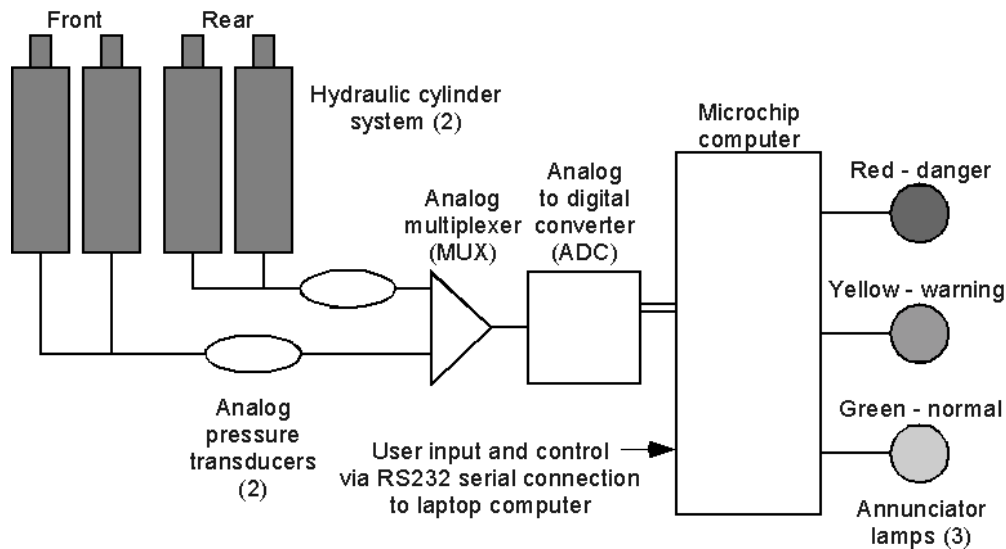

Figure 9. Diagram of load rate monitoring system.

With the cooperation of a major MRS manufacturer, the system was installed and tested on a MRS in the laboratory. It is anticipated that the addition of this type of device to MRSs will significantly improve the safety of room-and-pillar retreat operations using these machines.

Conclusions and Recommended Work

To eliminate setting and handling posts and reduce the number of miners required to work near the cave line and other dangerous locations, a remotely controlled MRS has been developed and field tested. Optimum use of MRSs depends on careful panel designs, mine orientation, and prudent primary support designs geared to expected geologic and stress conditions. MRSs have a limited zone of influence around them and thus can best be utilized in combination with other MRSs and in conjunction with ground monitoring systems.

An integrated ground monitoring system is being tested in which the simplicity of convergence measurements are combined with more elaborate load-rate monitoring on MRS leg cylinders. Measurements from four mines with various geologic and support conditions have shown that monitoring roof-floor convergence enables miners to detect unstable roof conditions within the whole area of the interest at the face. Monitoring load rates can also provide information on the stability of pillars and fenders.

References

- Barczak, T., and D. Gearhart, 1997. Full-Scale Performance Evaluation of Mobile Roof Supports. Paper in *Proceedings of 16th International Conference on Ground Control in Mining*, ed. by S. S. Peng and C. T. Holland (WV University, Morgantown, WV, Aug. 5-7, 1997). Dept. of Mining Engineering, WV Univ., pp 211-220.
- Barczak, T., and D. Gearhart, 1998. Performance and Safety considerations of Hydraulic Support Systems. Paper in *Proceedings, 17th International Conference on Ground Control in Mining*, ed. by S. S. Peng (Univ. of WV, Morgantown, WV, Aug. 4-6, 1998). Dept. of Mining Engineering, WV Univ., pp. 176-186.
- Habenicht, H., 1988. The Alpine Breaker Line Support (ABLS): A Means to Promote Full Extraction. Paper in *3rd International Conference on Innovative Mining Systems*, ed. by J. M. White (MO Univ., Rolla, MO, Nov. 2-4, 1987). MO Univ., pp. 22-29.
- Hay, K., S. Signer, M. King, and J. Owens, 1995. Monitoring Mobile Roof Supports. Paper in *Proceedings of 14th International Conference on Ground Control in Mining*, ed. by S. S. Peng (WV Univ., Morgantown, WV, Aug. 1-3, 1995). Dept. of Mining Engineering, WV Univ., pp. 55-62.

Howe, L., 1998. A Decade of Mobile Roof Support Application in the United States. Paper in *Proceedings, 17th International Conference on Ground Control in Mining*, ed. by S. S. Peng (WV Univ., Morgantown, WV, Aug. 4-6, 1998). Dept. of Mining Engineering, WV Univ., pp 187-201.

Maleki, H., 1981. Coal Mine Ground Control. Ph.D. dissertation, Colorado School of Mines, Golden, CO, 432 pp.

Maleki, H., 1988a. Ground Response to Longwall Mining--A Case Study of Two-Entry Yield Pillar Evolution in Weak Rock. *Colorado School of Mines Quarterly*, vol. 83, no. 3, 52 pp.

Maleki, H., 1988b. Detecting Stability Problems by Monitoring the Rate of Roof Movement. *Coal*, vol. 25, no. 12, pp. 34-38.

Maleki, H., 1990. Development of Numerical Modeling Procedures for Coal Mine Stability Evaluations. Paper in *Rock Mechanics Contributions and Challenges: Proceedings of the 31st U.S. Symposium*, ed. by W. A. Hustrulid and G. A. Johnson (CO Sch. Mines, Golden, CO, June 18-20, 1990). Balkema, pp. 85-92.

Maleki, H., and R. McVey, 1988. Detection of Roof Instability by Monitoring the Rate of Roof Movements. U.S. Bur. Mines Rep. Invest. 9170, 12 pp.

Maleki, H., and J. Owens, 1998. Analysis of the Interaction Between Mobile Roof Supports and Mine Strata. Paper in *Design and Construction in Mining, Petroleum, and Civil Engineering: Proceedings of the Fifth South American Congress on Rock Mechanics and Second Brazilian Conference in Rock Mechanics-SAR Rocks 98*, ed. by L. A. da Silva, E. F. de Quadros, and H. H. S. Conçalves (Santos, São Paulo, Brazil, Nov. 22-25, 1998). Univ. de São Paulo, Escola Politécnica, pp. 287-293.

Shepherd, J., and T. Lewandowski, 1992. Modified Wongawilli Extraction with Mobile Breaker Line Supports: Preliminary Geomechanics. *Australian Coal Journal*, no. 38, pp. 41-47.

Thompson, R., and J. Frederick, 1986. Design and Field Testing of Mobile Roof Support for Retreat Mining. Paper in *Proceedings, 5th Conference on Ground Control in Mining*, ed. by A. W. Khair and

S. S. Peng (WV Univ., Morgantown, WV, June 11-13, 1986). Dept. of Mining Engineering, WV Univ., pp. 73-78.

Wilson, H. G., 1991. Mobile Roof Support for Retreat Mining. Paper in *10th International Conference on Ground Control in Mining, Proceedings*, ed. by S. S. Peng (WV Univ., Morgantown, WV, June 10-12, 1991). Dept. of Mining Engineering, WV Univ., pp. 103-114.

Hamid Maleki received both MS and Ph.D. degrees from the Colorado School of Mines. He has worked as rock mechanics engineer for mining companies and geomechanics consultants for mining and nuclear waste industries. He is a principal with Maleki Technologies, Inc. Mr. John Owens received his BS degree from Gonzaga University. He is a mechanical engineer with the Spokane Research Laboratory (NIOSH). Mr. Howie is an electronics technician with the Spokane Research Laboratory.

ADDRESSES:

H. Maleki: maleki.tech@worldnet.att.net
Maleki Technologies, Inc., 5608 S. Magnolia, Spokane, WA 99203; (509) 448-7911; FAX (509) 448-7911

J. Owens: jd04@cdc.gov
Spokane Research Laboratory, NIOSH, 315 E. Montgomery, Spokane, WA 99207; (509) 354-8007; FAX (509) 354-8099

W. Howie: wch7@cdc.gov
Spokane Research Laboratory, NIOSH, 315 E. Montgomery, Spokane, WA 99207; (509) 354-8003; FAX (509) 354-8099