

## AN OVERVIEW OF BUREAU OF MINES COMMUNICATIONS RESEARCH

Harry Dobroski, Jr.  
John Durkin  
U.S. Department of Interior  
Bureau of Mines  
Pittsburgh Research Center  
Pittsburgh, PA 15236

### ABSTRACT

This paper presents a general overview of the Bureau of Mines' programs in the areas of operational and post-disaster communications. These programs encompass both hardware developments and system evaluations. Topics discussed include a new visual paging system compatible with existing pager phone lines, a means of modifying commercially available pager phones to permit selective paging and message leaving, a multiplexed telephone system that uses twisted shielded pair and requires no central control, medium frequency hardware developments, and a manual for mine communications.

Research has continued in the area of post-disaster location and communications. This research is based on seismic and electromagnetic techniques. Each has been extensively studied and field tested to better understand its ability to perform effectively. A brief description is given of the post-disaster program. Results are promising and provide insight into future areas of research.

### INTRODUCTION

It can hardly be argued that underground mining is a difficult complex activity. And although the future holds great promise for the coal industry, there will be those who float and those who sink. Those who float will be those who can supply a competitive product whose production depends on compliance with regulations, labor-management relationships, good equipment, and good management.

Good management is critical. It requires timely information on all aspects of a working mine, and an effective communication system is the key. It is not sufficient for a manager to think he knows where his key people are or what the underground situation is. To manage, he must know. Good communication permits good top-down management and this is often the difference between success and failure.

## I. OPERATIONAL COMMUNICATIONS RESEARCH

### Wired Communication Systems

This section describes new developments and research in the area of hard-wire communications. This includes improvements in standard page phone systems, two visual paging systems, and a multiplexed telephone system.

In addition, research is underway in other areas. Fiber optics is making significant inroads in commercial telecommunication systems. It is being evaluated to ascertain its applicability to underground mines. The advantages of large bandwidth, low cable costs, interference-free transmissions, and intrinsic safety are being weighed against cable splicing, tapping, and repair difficulties, higher interface costs, and other problems associated with a higher technology. A small fiber optics system is being developed and will be installed in the Safety Research Mine at Bruceton, Pa. Studies continued in the area of existing wire telephone lines. With the development of more sophisticated telephone and telemetry systems, more information is needed to learn if existing mine lines are sufficient from a bandwidth/loss/EMI standpoint to support such systems. Finally, there always remains the problem that in a mine emergency (fire, explosion, etc.) the communication and data lines are first to go, often rendering useless the telephone and monitoring systems. To get around this problem, studies are underway to learn the advantages and disadvantages of burying such cables.

### Selectable Pager Phones

Standard loud speaking pager phones are an important part of mine communications. They are inexpensive, versatile, and reliable. Unfortunately they also have several disadvantages. The user of a pager phone never knows if he or she is really getting through on the system unless someone answers. Also, each and every phone in the mine broadcasts a page every time. This may be good for general mine paging or emergency use, but it unnecessarily distracts workers who keep hearing messages not for them. In addition, continuous general paging uses up batteries quickly in all the phones. At about \$5 apiece for pager-phone batteries which may last only a few months under conditions like this, it quickly becomes expensive.

The Bureau of Mines has addressed this problem by developing a small circuit that can be added to any standard pager phone. (See figure 1.) The system features include--

- (1) Any pager phone can be paged selectively from any other pager phone.

- (2) Signaling is via dual tone multiple frequency (DTMF) techniques. The caller receives a tone feedback signal from the called phone indicating that it came on. This provides the caller with information regarding his phone, the called phone, and the intervening phone line.
- (3) The called phone pages in the normal manner, and flashes a light for a preset time (usually 20 minutes) or until the phone is answered.
- (4) Battery life is greatly enhanced because only the desired phones come on.
- (5) The "all call" feature of the standard pager phone is retained.

### Visual Paging

A useful complement to audio paging is visual paging. In a sense, the selectable pager phone uses visual paging to a limited extent by the flashing light on the called phone. In this section, visual paging refers to independent systems.

The advantage of visual paging over audio paging is that if no one is in the vicinity of the paging device when a page comes in, the message is not lost. Two visual paging systems were developed.

The first developed under contract, is a direct spin-off of earlier Bureau work. This system (See figure 2.) used electro-mechanical, retroreflective disks that can be "set" or "unset" by a dispatcher. Each disk carries a number or letter assigned to individuals or work functions. When an individual sees his number "set," he knows to contact the dispatcher at once or whatever phone system the mine uses, to receive a message. The system features include--

- (1) Uses the existing pager phone lines and is completely compatible with standard or selective pager phones.
- (2) Patch-panel programmable to permit single location, zone, or minewide paging.
- (3) Disk control via FSK at 14 kHz, 109 baud rate.
- (4) Interface to pocket pagers that permit radio paging to roving individuals.
- (5) Uses redundant transmission techniques to assure virtually error-free operation (that is, a 12-bit FSK word repeated four times).

- (6) Battery life comparable with pager phones.

The second visual pager system was developed in-house and is shown in figure 3. The system features include--

- (1) DTMF signaling from a dispatcher's control panel with a supervisory tone feedback.
- (2) The use of a liquid crystal display instead of electro-mechanical disks.
- (3) The prototype system will post three two-digit numbers from 11 to 99. These three numbers "roll" through the display on 2-second intervals and have individual (usually 20-minute) time-outs. In addition the dispatcher can clear the numbers if desired to cancel the page or post ones of higher priority.
- (4) Provisions for remote control of alarm or other functions.
- (5) Power consumption is nominally 0.5 ma at 6 vdc, resulting in long battery life.

#### Multiplexed Telephone System

A multiplexed telephone system is being developed that provides eight voice-grade channels. The system is based on modern micro-processor technology using no central control and twisted shielded pair cable. Phones can be attached to the line at any place, and the failure of individual phones does not affect general system operation. (See figure 4.)

System features include--

- (1) Eight channels available for narrowband FM duplex voice or duplex data, FSK, Bell spec 103.
- (2) System control via digital signaling at 30 kHz. Voice and data channels, 320 kHz to 640 kHz.
- (3) System operation controlled directly by the phones, requiring no central control or repeaters.
- (4) Full system versatility where phones can be located anywhere along the line, similar to pager phones.
- (5) Very low power consumption. The system receives power from an intrinsically safe power supply. Internal backup batteries provide emergency power at the phones.
- (6) Easily installed and maintained cable. Initial plans call for No. 14 gauge twisted shielded cable. This cable offers good mechanical strength, electrical characteristics, and high immunity to mine electromagnetic interference (EMI). Preliminary tests show little degradation in transmission when grounds and terminations are not intact.

## Wireless Systems

The ultimate communication system for mines is one where any person could communicate with any other person in the mine or on the surface complex. In reality, this is not achievable because of distances involved, power requirements, and other factors. Nevertheless, systems have been and are being developed that promise to go far to meet this ideal.

Ultra-high frequencies (UHF) offer excellent local coverage and long distance linear coverage if used with leaky feeder cables. Using reflection techniques, it is possible to even do away with the leaky feeder cable, if mine entryways are large enough. With modification, UHF systems can be interfaced with pager phone lines to permit special coverage.

Medium frequency (MF) promises excellent whole mine coverage also. The advantage of MF is that it can use existing mine wiring to extend its range. Much basic research has already been done in underground MF propagations with more planned. Hardware is being built that will demonstrate the characteristics of MF under minewide operational conditions.

## UHF Systems

UHF systems have been available to the underground mining industry for many years and have met with various degrees of success. Most use a leaky feeder cable deployed throughout the mine. This cable permits radio-to-radio communications as long as both radios are within range of the cable.

UHF systems need not be confined to such cables to achieve mine-wide coverage. Bureau of Mines research in the area has shown that reflective techniques can also be employed if the mine entries are large enough. Although research in this particular area has been confined to a room and pillar noncoal mine, the application to coal mines is obvious. (See figure 5.)

With this system, nonradiating coaxial cable is installed in various mine areas with antennas mounted in key crosscuts. When so deployed, the antennas radiate and receive signals for several thousand of feet in four directions. Vehicles and personnel situated in these prime entries are therefore in voice communication with the rest of the UHF system.

Reflection techniques are used whenever coverage is desired in secondary areas. The situation is analogous to reflecting light around a corner with a mirror. Since the entryways are large, the reflectors and antennas present no obstacles to personnel or machines. The system has given excellent results under the following conditions:

- (1) Repeater power 10 w; vehicular power, 10 w; personnel radio power, 1 w.
- (2) Entry size, 30 ft high by 30 ft wide. (Limestone Mine)
- (3) Reflector size, 4 ft by 4 ft.

#### A UHF Extender System

No matter how well a UHF system (leaky feeder, reflector, etc.) may be configured for a mine, situations always exist where additional coverage is sometimes needed. An example might be a temporary work area in a remote section of the mine that is rarely used. It is usually not practical to try to cover the area by extending the leaky feeder cable or using reflectors. However, running phone lines is rarely a problem. Because of this, the Bureau has developed a simple UHF extender system using phone lines. (See figure 6.)

The system is designed around commercially available 8, 3, or .7 w UHF base station radios operating at 451 MHz. In operation, UHF portable radios need only be in range of one such base. When the base reserves a transmission, a keying signal and audio are impressed on a twisted wire pair line where a second base station at the other end receives and retransmits. Therefore, the system offers area coverage from area 1 to area 2, and vice versa. It can be easily seen that if one of the areas overlap that of a primary area such as a leaky feeder cable, communication between the two systems is achieved. It can further be seen that any two-wire phone line can be used, even one containing pager phones.

#### Medium Frequency (MF) Research

Over the past several years, the Bureau has been involved in MF research in coal mines. (1)\* Numerous in-mine tests have been conducted to learn the characteristics of MF in various geographical and geological locations in the major coalfields, in areas of mines that contain many conductors, and in areas that do not. Simple theoretical models were formulated (2) that characterize MF propagation and predict the most favorable frequencies and maximum communication ranges.

For conductor-free areas, a three-layer model was developed and verified. The propagation mode takes the form of a parallel plane (0, 0) TEM mode with E vertical and H horizontal. The model assumes the coal seam is bounded above and below by rock of higher conductivity than the coal. The model fits actual data best between 200 to 1,000 kHz and shows a wide band at 300-700 kHz where range is greatest.

---

\* Numbers underscore in parentheses refer to items in the list of references at the end of this paper.

Certain coal seams exhibit unfavorable characteristics where the operating range in conductor-free areas is only about 250 ft. In other more favorable coal seams, the range is up to 1,200 ft. If conductors intersect the areas, range is greatly enhanced.

Since MF propagation is greatly influenced by the electrical properties of the surroundings, it is necessary to investigate this propagation in noncoal mines also. Such a measurement program will soon be underway. Coal is found in sedimentary deposits where various layers have different electrical properties. Other minerals are often found in bulk deposits. Therefore, the MF propagation in such mines, especially in nonconductor areas, is expected to be quite different.

One of the problems of evaluating MF on a systems basis is that no commercially available hardware exists with the proper operational features. The small portable units of low power or modified carrier-current equipment that can be purchased, are of little value in a systems evaluation.

To solve this problem, the Bureau is developing MF hardware suitable for systems evaluation. It consists of portable and vehicular units, base stations, and repeaters. Prototype hardware is expected around mid 1981. Figure 7 shows a typical system configuration.

## II. POST DISASTER TECHNIQUES

Since the earliest days of underground mining, miners have had to face the possibility of major disasters. These disasters usually take the form of fires or explosions, although flooding and massive roof falls have also taken many lives. Following any such disaster, two fundamental questions exist: "Is anyone alive?" and if so, "Where are they?" Addressing this problem, government agencies and the mining industry have encouraged and financed the development of equipment and rescue teams.

Since the early 1970's, the Bureau of Mines has conducted research in hardware and techniques to locate and communicate with trapped miners. This research was recommended by the National Academy of Engineers (NAE) (3) and falls into two general categories: Seismic and electromagnetic (EM). This section discusses the latest developments in the area of EM detection techniques.

### The Basic System

The basic EM system developed several years ago is based on a narrowband voice frequency (VF) uplink signaling transceiver that uses power from a standard cap lamp battery. (See figure 8.) A low duty cycle of the transmitted signal assures that operation is possible for 3 days on a fully charged new battery or about 1 day on an average 2-year old battery that had already been used 8 hours for the light.

The underground unit consists of a VF transmitter and baseband receiver referred to as the underground "transceiver." Surface receivers were developed that could be carried by helicopter to permit rapid large area searches, or by personnel on foot, to do accurate locations. Large surface baseband transmitters were developed that permitted the surface personnel to communicate with the trapped underground personnel, once the location was made. In operation, the trapped miner would deploy the underground transceiver, which would signal through the earth. Once detected, the surface crew would talk to the miner via VF to learn of mine conditions and give instructions. The surface crew would ask yes-no type questions that could be answered by simply keying a button on the transceiver.

In order to obtain the necessary confidence that the system would operate in typical coal mines in different geographical and geological areas, a rigorous field test program was conducted from 1976 to 1978.

Although the basic EM system has many advantages, it also has several shortcomings. Because location is based on characteristics in the horizontal magnetic field, it provides no information about the depth of the underground transceiver. This is generally no problem in coal mines where only a single level is being mined. However, in multilevel mining common in metal and nonmetal mining, this could create problems. In these cases, depth information is required. A second shortcoming is that the accuracy of the location is a function of how level the underground antenna is deployed. An antenna on an angle produces a displaced field that affects accuracy. The third shortcoming is based on the fact that signal detection and location depends on the skill of a human operator. Some search personnel can detect and locate weak signals much better than others. These shortcomings prompted research in developing better systems.

The desirable characteristics of improved systems follow:

- (1) Full automation, except for deployment.
- (2) A reduction of ground effects and depth considerations.
- (3) Elimination of antenna orientation effects on location accuracy.
- (4) Simple inexpensive underground hardware.

#### Electromagnetic Deep Mine Transmitter

Thru-the-earth detection and location systems based on VF permit the use of simple hardware and detection techniques. But because of the earth attenuation, it is necessary to go lower in frequency as depth increases. One goal is to develop a system useful to 3,000 ft, a range useful for coal mines for decades to come. To achieve this goal, sub-ELF frequencies (10 Hz) are necessary.



One fundamental problem of transmitting EM through the earth at these frequencies is that on the surface, the received signal energy is inversely proportional to the sixth power of depth. Hence it is about 1,000 times more difficult to receive signals from a 3,000 ft mine than a 1,000 ft mine, other factors being equal. The problem is compounded by the limited amount of energy available to the trapped miner (the cap lamp battery) and by electromagnetic interference (EMI) at the surface. A system is presently being developed to solve these problems.

It consists of a continuous wave (CW) transmitter (10 Hz) deployed underground similar to the previous system. On the surface three 3-axis antennas are deployed to receive the signal, and a fourth antenna, remotely deployed, is used for atmospheric EMI cancellation. All antennas are connected to a central processor via hard wire or radio links.

Because of the very weak signals, several minutes of CW integration are necessary. The ELF used permits free space propagation calculations. Hence, if the precise location of the surface antennas are known, vector analysis of the electromagnetic field produced by the underground transmitter is sufficient to calculate the location of the source.

#### Adaptive Transmitter System

A novel approach to extend the detection range of trapped miner transmitters is based on adaptive retransmission. This approach combines adaptive transmission lengths, automatic feedback, and signals having large time-bandwidth product and ideal autocorrelation.

In operation, the trapped miner transmitter sends out 34 sec of signal followed by a 6-sec pause. The signal is received by a receiver/repeater that uses coherent integration in matched filters. The receiver integrates the signal until a threshold is reached. Depending on signal strength this threshold can be reached with the first 34-sec "block" of signal from the transmitter, or it may require up to 16 blocks from the transmitter. When the threshold is reached, the receiver/repeater (a far more powerful transmitting device than the underground transmitter) transmits a signal back underground indicating that sufficient signal was received and detection is acknowledged.

If the receiver/retransmitter is located on the surface, a three-axis receiving antenna system can be used for vector analysis of the signal and hence location. An alternative would be for the trapped miner to encode position information in a second series of transmissions.

## Through-the-earth Voice Communications

The basic trapped miner transceiver described previously has voice downlink reception capabilities. This is possible because the surface rescue team have large amounts of power at their disposal, usually engine-generator sets and can therefore use powerful baseband amplifiers and large loops to communicate with the miner using sheer power. A base band magnetic moment of  $10^5$  amp turns  $M^2$  is not uncommon. But the miner trapped underground is limited in power, the only source being the cap lamp battery. It is for this reason that uplink code-keying, yes-no type answers to downlink voice questions is used.

To advance research in the area of voice communications, a theoretical study is underway to study performance levels of analog and digital voice communications. This is being done by computer modeling, considering earth models and EMI. The expected speech intelligibility can then be predicted. Field tests are planned using different communication systems and prerecorded phonetically balanced word lists. Later, a listening panel will determine the intelligibility of the received signal which will verify computer models.

### PUBLICATIONS

A vast amount of research has been done over the years on mine communications by the Bureau and private industry. This research is usually in the form of hundreds of highly technical engineering reports, useful only to experts in the field. In addition spec sheets, new product brochures, etc., from industry add to this wealth of knowledge. Unfortunately, information in this form is not very useful to people in the mining industry who must specify, identify, and ultimately live with systems that may actually not be what they need. A general educational overview is not available. The Bureau has addressed this problem by developing a series of publications that will assist mine managers, mining engineers, etc., in understanding mine communications and monitoring.

The first, entitled "Underground Mine Communications, Control, and Monitoring" has reduced the research to understandable terms, presents system operational features, lists suppliers, etc. In general, it gives an overview that makes the selection of a system to meet actual mine needs more likely. This publication will be available in 1981.

A series of application guidelines specific to certain areas, have also been developed. The first, "Technical Guidelines for Installing, Maintaining, and Inspecting Underground Telephone Systems" is available upon request. A second entitled "Guidelines for Installing and Upgrading Trolley Carrier Phone Systems" will be available in 1981. A third will address radio systems and should be available in 1982.

## SUMMARY

Research has continued in developing improved telephone and wireless communication systems for mines. Fiber optics, selectable pager phones, visual pagers, and advanced telephone systems will play even larger roles in mine operations. The improvements in operational and managerial control are many.

Post-disaster systems are also being developed that show great promise. Since the trends in energy development are toward coal, this means more miners underground in deeper, gassier mines. The potential for disasters can only increase, in spite of stricter enforcements and better equipment. The post-disaster program is devoted to reducing the risks to the smallest point possible.

## REFERENCES

1. Collins Radio Company, Propagation of EM Signals in Underground Mines, H0366028, OFR No. 136-78\*; Electromagnetic Propagation in Low Coal at Medium Frequencies, H0377053.
2. Little, Arthur D. Inc., Modeling and Data Analysis of 50 to 5,000 kHz Radio Wave Propagation in Coal Mines, H0346045. OFR 20-76.
3. National Academy of Engineering, Mine Rescue and Survival, S190606. OFR 4-70, NTIS No. PB 191 691.\*\*
4. Westinghouse, Trapped Miner Location and Communication System, OFR 41-74 (4 volumes); NTIS PB 235 605/AS; 235 606/AS; 235 607/AS 235 608/AS. Also, Penn State University, Theoretical Investigation of Seismic Waves Generated in Coal Mines, G0155044.

\* Open File Reports (OFR's) are available for reference only at the following Bureau of Mines libraries: Denver, Colo.; Twin Cities, Minn.; Bruceton and Pittsburgh, Pa.; Spokane, Wash.; and the National Library of Natural Resources, U.S. Department of the Interior, Washington, D.C.

\*\* National Technical Information Service (NTIS) items are available from National Technical Information Service, Springfield, Virginia 22161. The PB number should be given when ordering. Prices for publications are \$3 for microfiche and range from \$4 to \$16.50 depending on the number of pages for printed copy.

Contact the author of this paper regarding all other reports listed.

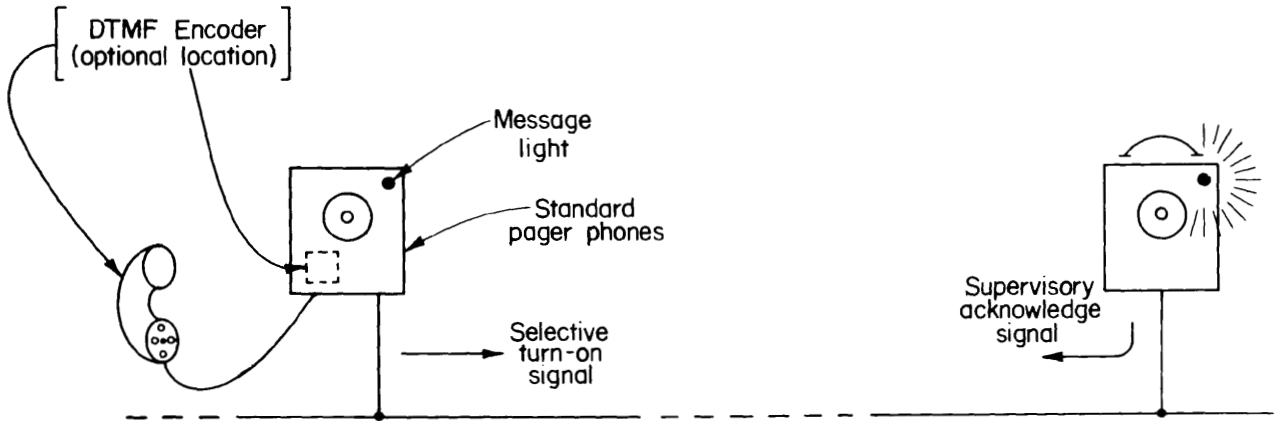

1. Selectable Pager Phone System

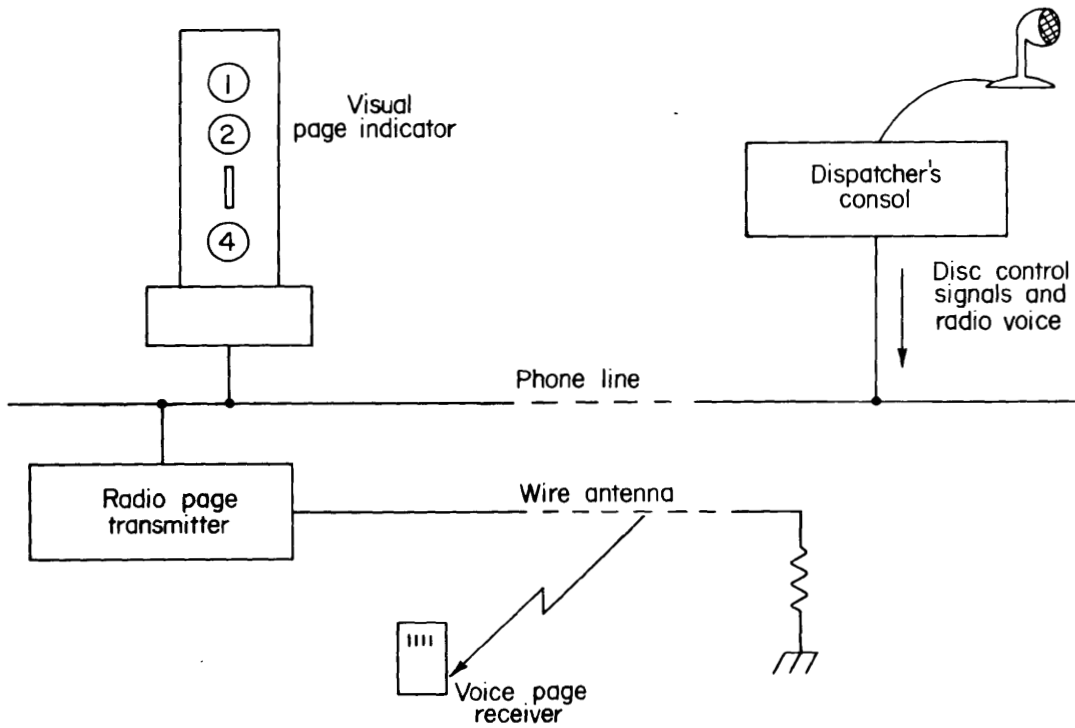

2. Disk-type Visual Pager System

PGH-90  
521

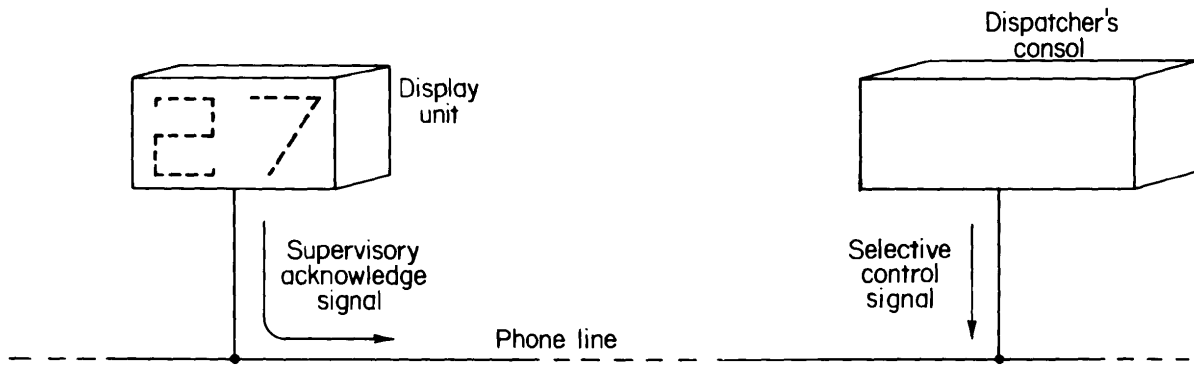

3. Liquid Crystal Visual Pager System

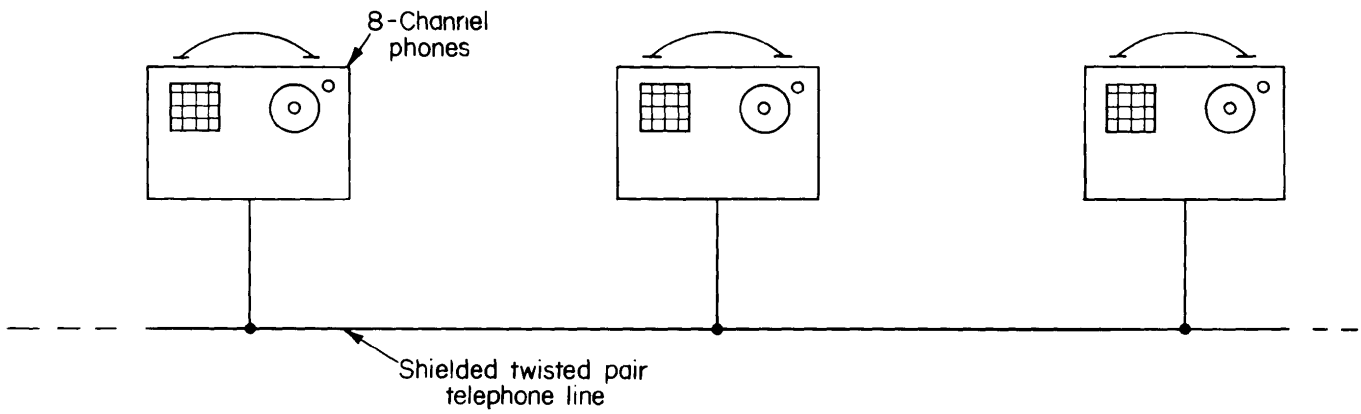

4. 8-Channel Multiplexed Telephone System

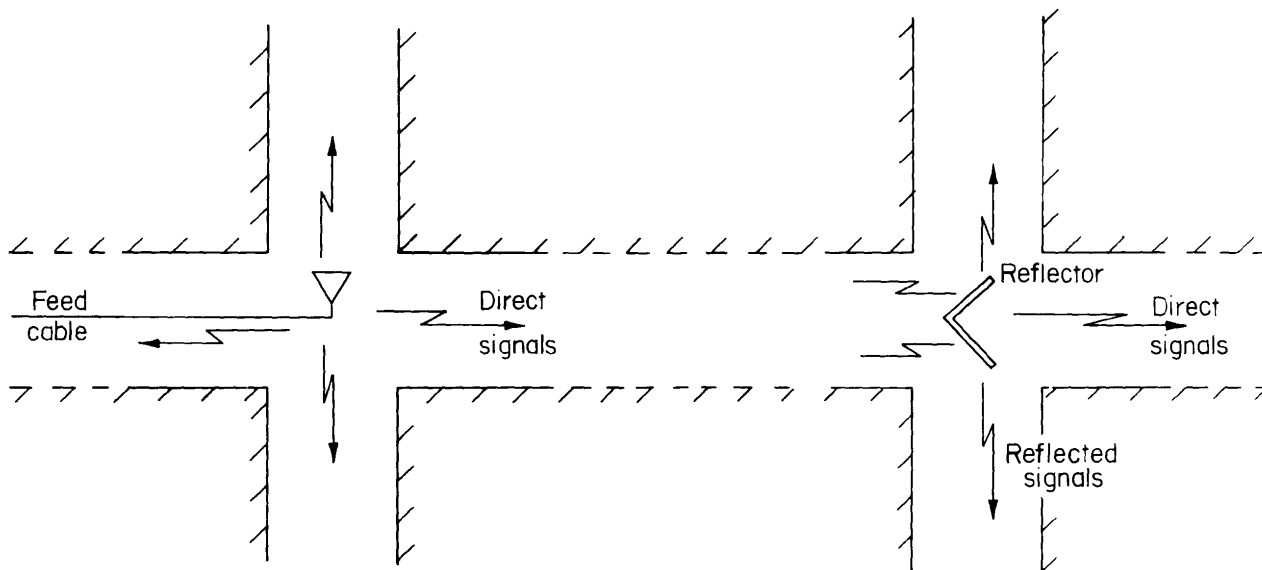

5. UHF Reflection System

PGW-80  
522

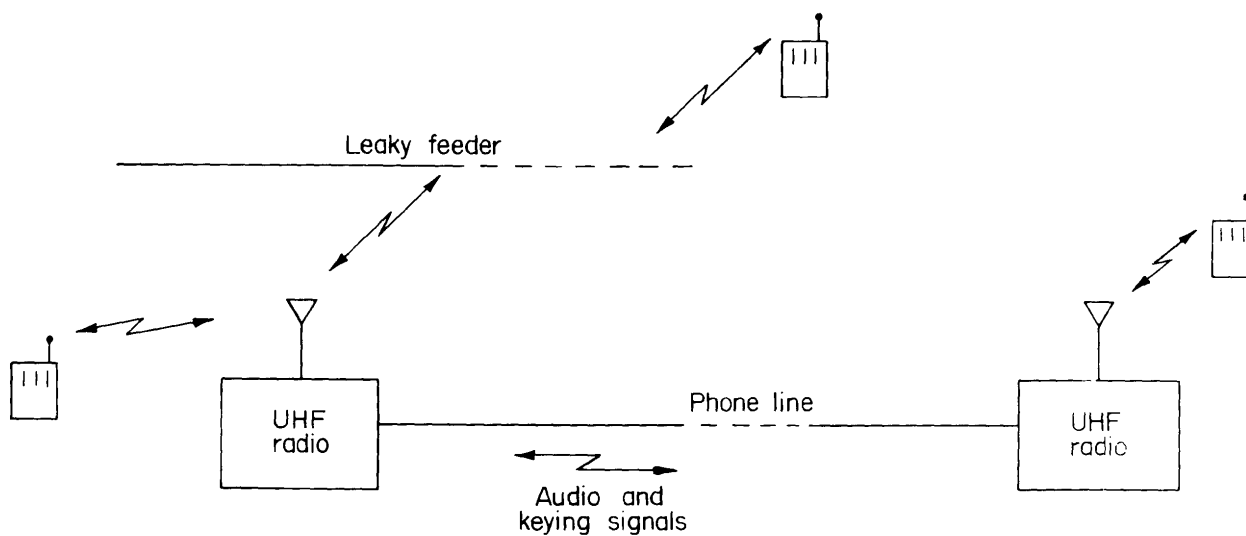

6. UHF Phoneline Extension System

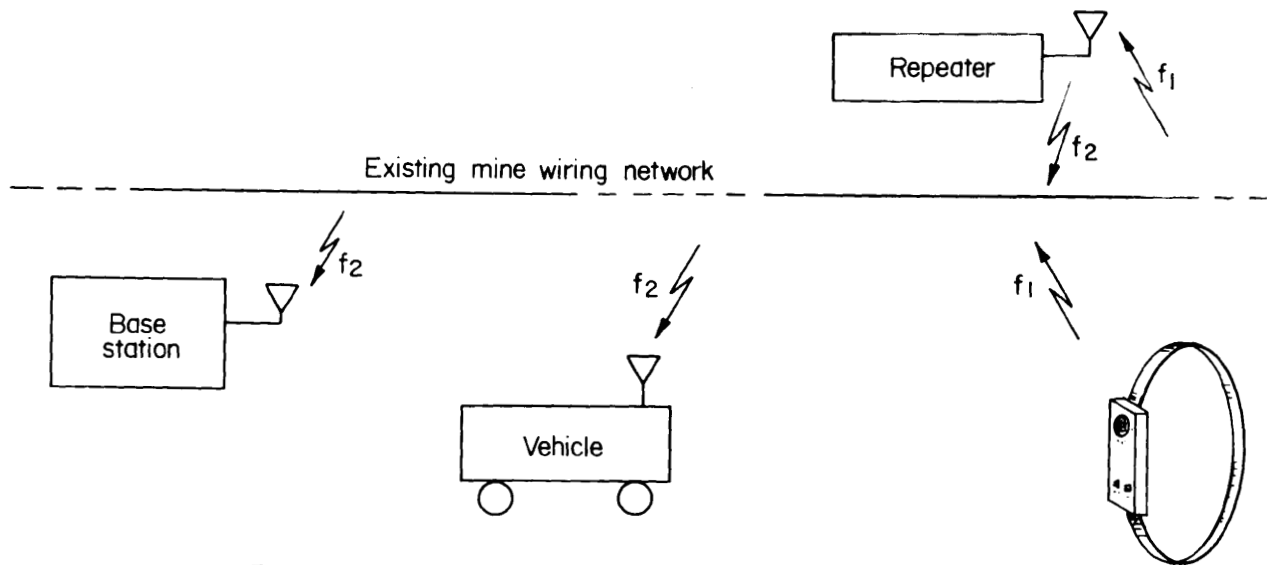

7. Whole Mine Medium Frequency Configuration

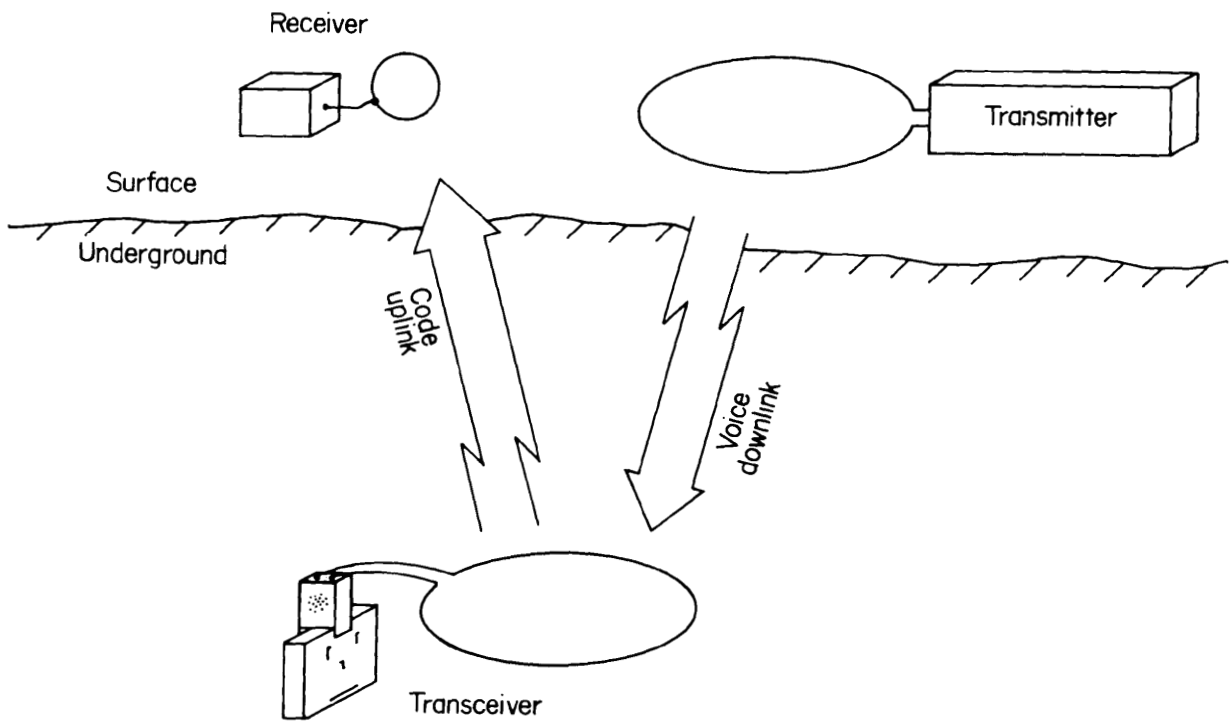

8. Basic EM Trapped Miner System