



*RI 9670*

*REPORT OF INVESTIGATIONS/2006*

# Lower Respirable Dust and Noise Exposure With an Open Structure Design



Department of Health and Human Services  
Centers for Disease Control and Prevention  
National Institute for Occupational Safety and Health



**Report of Investigations 9670**

**Lower Respirable Dust and Noise Exposure  
With an Open Structure Design**

**By Andrew B. Cecala, James P. Rider, Jeanne A. Zimmer, Robert J. Timko,  
and Earle H. Andrews**

DEPARTMENT OF HEALTH AND HUMAN SERVICES  
Centers for Disease Control and Prevention  
National Institute for Occupational Safety and Health  
Pittsburgh Research Laboratory  
Pittsburgh, PA

November 2006

**This document is in the public domain and may be freely copied or reprinted.**

## **DISCLAIMER**

Mention of any company or product does not constitute endorsement by the National Institute for Occupational Safety and Health (NIOSH). In addition, citations to Web sites external to NIOSH do not constitute NIOSH endorsement of the sponsoring organizations or their programs or products. Furthermore, NIOSH is not responsible for the content of these Web sites.

## **ORDERING INFORMATION**

To receive documents or other information about occupational safety and health topics, contact NIOSH at

NIOSH—Publications Dissemination  
4676 Columbia Parkway  
Cincinnati, OH 45226-1998

Telephone: **1-800-35-NIOSH** (1-800-356-4674)  
Fax: 513-533-8573  
e-mail: [pubstaft@cdc.gov](mailto:pubstaft@cdc.gov)

or visit the NIOSH Web site at [www.cdc.gov/niosh](http://www.cdc.gov/niosh)

DHHS (NIOSH) Publication No. 2007-101

November 2006

**SAFER • HEALTHIER • PEOPLE™**

## CONTENTS

	<i>Page</i>
Abstract.....	1
Introduction.....	2
Testing.....	3
Test equipment.....	3
Dust control.....	3
Real-time aerosol dust monitors .....	3
Gravimetric dust sampling.....	3
Noise control.....	4
Structures evaluated.....	5
Structure No. 1 .....	5
Structure No. 2.....	6
Structure No. 3.....	9
Results.....	10
Respirable dust.....	10
Noise.....	12
Discussion.....	14
Conclusions.....	17
References.....	18

## ILLUSTRATIONS

1. Dust and noise sampling instrumentation setup at masonry structure No. 1 .....	6
2. A researcher inspects sampling equipment at open structure No. 2 .....	7
3. Dust and noise sampling instrumentation setup at open structure No. 2.....	8
4. Dust and noise sampling instrumentation setup at steel-sided structure No. 3.....	9
5. Sound pressure levels versus distance in structure Nos. 1 and 2.....	13
6. Comparison of walled and open structure design for same size mineral processing building.....	17

## TABLES

1. Average respirable dust concentrations for the three product sizing structures .....	10
2. Production levels for the evaluation period for the three product sizing structures .....	11
3. Calculated respirable dust concentration per ton of product processed for the three structures evaluated.....	11
4. Sound pressure levels of structure No. 1: reverberant environment.....	12
5. Sound pressure levels of structure No. 2: open environment .....	12

## UNIT OF MEASURE ABBREVIATIONS USED IN THIS REPORT

db	decibel	mg	milligram
ft	foot	mg/m <sup>3</sup>	milligram per cubic meter
ft <sup>3</sup>	cubic foot	min	minute
hr	hour	mm	millimeter
Hz	hertz	sec	second
L/min	liter per minute	μm	micrometer

# LOWER RESPIRABLE DUST AND NOISE EXPOSURE WITH AN OPEN STRUCTURE DESIGN

By Andrew B. Cecala,<sup>1</sup> James P. Rider,<sup>2</sup> Jeanne A. Zimmer,<sup>3</sup> Robert J. Timko,<sup>4</sup>  
and Earle H. Andrews<sup>5</sup>

---

## ABSTRACT

Many different types of structures and materials have been used to build mineral processing facilities over the past few decades. Although the structure type and building material were not viewed as significant factors affecting the health of employees in these facilities when they were built, the National Institute for Occupational Safety and Health performed an evaluation to determine to what extent building types could impact respirable dust and noise levels. This report discusses the evaluation of three different types of product sizing silica sand structures: a masonry design, a steel-sided design, and an open structure design. The data obtained in this study indicate that the open structure design (no walls) was superior from both a dust and noise (health) standpoint compared to the other two structures. The open structure design should also be beneficial from a cost standpoint because of lower material and construction costs. Companies and design engineers should consider this open design when building new mineral processing facilities in climates where it could be applicable. Some companies may also want to consider modifying existing structures with a more open design to further reduce dust and noise levels. As the trend continues in lowering allowable dust levels for federal health standards in the U.S. mining industry, the open structure design may be an approach for some companies to consider for their operations.

---

<sup>1</sup>Mining engineer, Pittsburgh Research Laboratory, National Institute for Occupational Safety and Health, Pittsburgh, PA.

<sup>2</sup>Operational research analyst, Pittsburgh Research Laboratory, National Institute for Occupational Safety and Health, Pittsburgh, PA.

<sup>3</sup>Physical science technician, Pittsburgh Research Laboratory, National Institute for Occupational Safety and Health, Pittsburgh, PA.

<sup>4</sup>Supervisory research physical scientist, Pittsburgh Research Laboratory, National Institute for Occupational Safety and Health, Pittsburgh, PA.

<sup>5</sup>Manager, Occupational Health and Safety, U.S. Silica Co., Berkeley Springs, WV (retired).

## INTRODUCTION

Workers at mineral processing facilities are often exposed to high levels of respirable dust and noise. Federal compliance records have shown that workers at these facilities have some of the highest respirable dust and noise exposure rates in the entire metal/nonmetal mining industry [NIOSH 1999; Stephenson and Merry 1998; Watts and Parker 1995]. Since many of these operations process ore containing some percentage of silica, the health risk to these workers is even greater because of the possibility of developing silicosis [Kreiss and Zhen 1996; Hnizdo and Sluis-Cremer 1991; Ng and Chan 1994; Rice and Herring 1995; Steenland and Brown 1995]. For many years, the National Institute for Occupational Safety and Health's (NIOSH) Pittsburgh Research Laboratory has been performing research to lower dust and noise exposures to workers at mineral processing operations. The vast majority of this research has been directed at source control techniques for a particular job function [Cecala and Covelli 1991; Cecala et al. 1984; Cecala et al. 2000; Hennings 1980; Pokora et al. 1984; Rubin et al. 1982; U.S. Bureau of Mines 1983; Volkwein and Gaynor 1985]. Although this research has been successful for a particular job function or application, there has been very little control technology developed to lower exposures to multiple workers or job functions throughout an entire structure.

One such study occurred back in the early 1990s with the development of the total mill ventilation system for mineral processing facilities [Cecala et al. 1993]. This system was effective at lowering respirable dust concentrations throughout an entire structure in a cost-effective manner. A total mill ventilation system consists of a calculated number of exhaust fans that are placed on the roof or very high on the exterior walls of a structure to induce a ventilation flow pattern up through the building. Make-up air inlets should then be located along the base of the building and should consider two main factors. First, the intake air inlets need to provide clean (non-dust-laden) outside air into the structure. Second, these air inlets should be strategically located to provide an effective sweeping of the major dust-laden areas as the intake air moves up through the structure. Respirable dust reductions ranging from 40% to 65% were recorded throughout these structures during a number of field studies to evaluate this technique.

This study provided the impetus to broaden NIOSH's research to consider more global techniques that could be used to improve the health of workers at mineral processing operations. Through various discussions with industry safety and health specialists, it was hypothesized that the open structure design may provide some overall improvements to dust and noise levels throughout an entire structure when compared to conventional walled structures. This hypothesis led to the development of this research study to evaluate the different types of building structural designs and materials used at mineral processing operations to determine the potential impact of each on dust and noise levels on a comparative basis. The primary goal of this research was to provide design engineers and companies with information to consider when designing new mineral processing facilities. If the open structure design proved to be advantageous from a health standpoint, some operations could also contemplate modifying existing structures by removing wall panels in an effort to lower dust or noise levels.

## TESTING

A test plan was established to provide a valid comparison of respirable dust and noise levels at the three different structures evaluated in this study. This section describes the equipment used in this evaluation, the physical characteristics of each of the three structures, and the equipment setup at each structure.

A significant factor affecting respirable dust and noise levels in these facilities was the production rate during each evaluation. Under normal conditions, higher production rates correlate with higher dust and noise levels, although there may be some extenuating circumstances that may cause this to change. Production rates at these facilities were recorded by operations personnel, and this information was then provided to NIOSH.

### Test Equipment

#### Dust Control

Respirable dust measurements were taken using both real-time aerosol monitors (RAM-1) and gravimetric samplers. Both of these dust instruments use a 10-mm Dorr-Oliver cyclone to classify the respirable portion of dust, usually considered to have aerodynamic diameters of 10  $\mu\text{m}$  or less.

#### *Real-time Aerosol Dust Monitors*

RAM-1 dust monitors (MIE, Inc.) were used to sample respirable dust concentrations for each of the three structures evaluated. The RAM-1 monitor measures instantaneous respirable dust concentrations by drawing an air sample into a sensing chamber and passing it through a light beam. A detector in the chamber produces an electrical signal proportional to the amount of dust in the air stream [Williams and Timko 1984]. These instruments were used to measure dust concentrations continuously in this study, except during brief periods of data transfer and calibration. The RAM-1 has been used for many years in dust research and has proven to be a very reliable and accurate device. The dust data from the instruments were stored on Metrosonic 331 or Telelog 2101 dataloggers that averaged the dust concentration at predetermined periods (either 30-sec or 1-min averages for this testing). Approximately every 8 hr, the information recorded on the dataloggers was downloaded and stored on a laptop computer. The RAM-1 dust monitors were recalibrated during this time. Once all testing was complete, the dust data stored on the computer were taken back to the laboratory and analyzed using commercially available software packages.

Testing was performed daily, with midnight considered as the start and stop time for each day of testing.

#### *Gravimetric Dust Sampling*

A gravimetric dust sampling package was used along with the RAM-1 dust monitor at most of the dust sampling locations for the various evaluations. Each gravimetric sampling package was composed of three or four individual sampling units. Each individual sampling unit was operated by a Mine Safety Appliances (MSA) Escort ELF sampling pump preset at a flow



rate of 1.7 L/min. MSA established this flow rate for use with the 10-mm Dorr-Oliver cyclone. This was then mandated by the Mine Safety and Health Administration for respirable dust sampling for the metal/nonmetal mining industry (30 CFR<sup>6</sup> 56.5001).

Respirable dust was classified by the 10-mm cyclone and deposited on a 37-mm-diam MSA dust filter cassette. The filters were pre- and postweighed to the nearest 0.001 mg on a Cahn C-31 microbalance. The dust concentration of each individual sampling unit was calculated based on its own run time, then the concentrations of three or four units were averaged together to determine the average respirable dust concentration for the entire gravimetric dust sampling package.

For approximately every 10 gravimetric filters used during a field test, one control filter cassette was set aside for calibration purposes. These control filter cassettes remained unused during the dust sampling period, but were pre- and postweighed to determine any biases in the weighing process. A correction factor was determined based on the average differences between all the pre- and postweighed control filters. This correction factor was then applied to the final value for all field gravimetric measurements.

The gravimetric samples were only operated on a single-shift basis per day, which normally occurred during the daylight shift. In addition to providing the average dust concentration over the sampling period, the gravimetric sampling package provided a dust range to verify that the RAM-1 devices were recording properly. The gravimetric and RAM-1 dust averages were not expected to be identical because of variations in sampling times, but the dust values obtained using both methods were expected to be similar, assuming everything was working properly.

## **Noise Control**

Experiments to measure the spatial distribution of sound levels were conducted in two screening towers (structure Nos. 1 and 2). In order to minimize background noise, plant operations were suspended while acoustical tests were conducted. Tests to measure the acoustic environment were performed using an external sound source with a known sound power level. A Brüel & Kjær (B&K) 4205 Sound Power Source unit was used for all testing. The unit consisted of two separate components: a noise-generating system and an external sound device. The noise generation system was composed of amplifiers, octave band filters, attenuators, and sound intensity controls. Two loudspeakers and associated crossover networking were used as the external sound source. The sound power output was controlled with an attenuator in 10-dB increments with a 40-dB range. Sound levels were measured and recorded with a B&K microphone and preamplifier as input to a Nagra recorder.

Tests conducted at the two screening towers (structure Nos. 1 and 2) used the following experimental protocol. The external sound source was placed on the ground floor of both structures in a central location as far away from the plant equipment as physically possible. A sound power level of 100 dB was selected for all experiments. A measuring microphone was mounted on a tripod approximately 66 inches above the floor and positioned at seven different locations throughout each of the structures. Tests were initiated by energizing the noise source on the ground floor, and sound levels were stabilized for approximately 1 min. Noise data were measured and recorded for 45 sec at each of the seven octave bands ranging from 125 to

---

<sup>6</sup>*Code of Federal Regulations.* See CFR in references.

8,000 Hz. A minimum of three data points were measured at each of the seven microphone locations. Noise data from the two screening towers were subsequently analyzed in the laboratory with a digital frequency analyzer. A 32-sec linear averaging time was used to calculate 1/3-octave band spectra from 63 to 8,000 Hz.

### **Structures Evaluated**

Although five different structures were evaluated throughout the entire course of this research effort, only three of the structures where product sizing was performed will be considered in this report, as discussed below. All of these structures were processing silica sand material. Structure Nos. 1 and 2 used the screening technique for product sizing, whereas structure No. 3 used an air separation technique. The other two structures evaluated in this research were grinding mills, but their production levels were orders of magnitude greater than the product sizing facilities and thus not readily comparable for this evaluation. Following is a brief description of each of the three structures evaluated in this report. Acoustical evaluations were performed only in the first two structures since personnel and budgetary restrictions did not allow for testing at the third facility.

#### **Structure No. 1**

Structure No. 1 was a nine-story building with steel framing and a masonry block construction. This building was a three-tier design with a depth of 32 ft for the entire structure. The first tier was approximately 50 ft high and 33 ft wide, the second was 63 ft high and 25 ft wide, and the third was 108 ft high and 42 ft wide. The third tier sat on product storage silos for bulk loading that were approximately 50 ft high, making the actual inside height of the building 58 ft. The volumetric capacity of the structure was calculated to be 204,000 ft<sup>3</sup>.

Dust testing was performed for 4 days. After this initial test series was completed and the data analyzed, 1 additional day of testing was performed. Both RAM-1 and gravimetric samplers were used at all dust monitoring locations. Because plant operations had to be suspended during the noise study, all testing took place on off days or during scheduled maintenance. Microphones recorded noise data for at least a 45-sec time period at the seven sampling locations and for each octave band ranging from 125 to 8,000 Hz. Figure 1 shows the locations for dust and noise instrumentation in this structure.

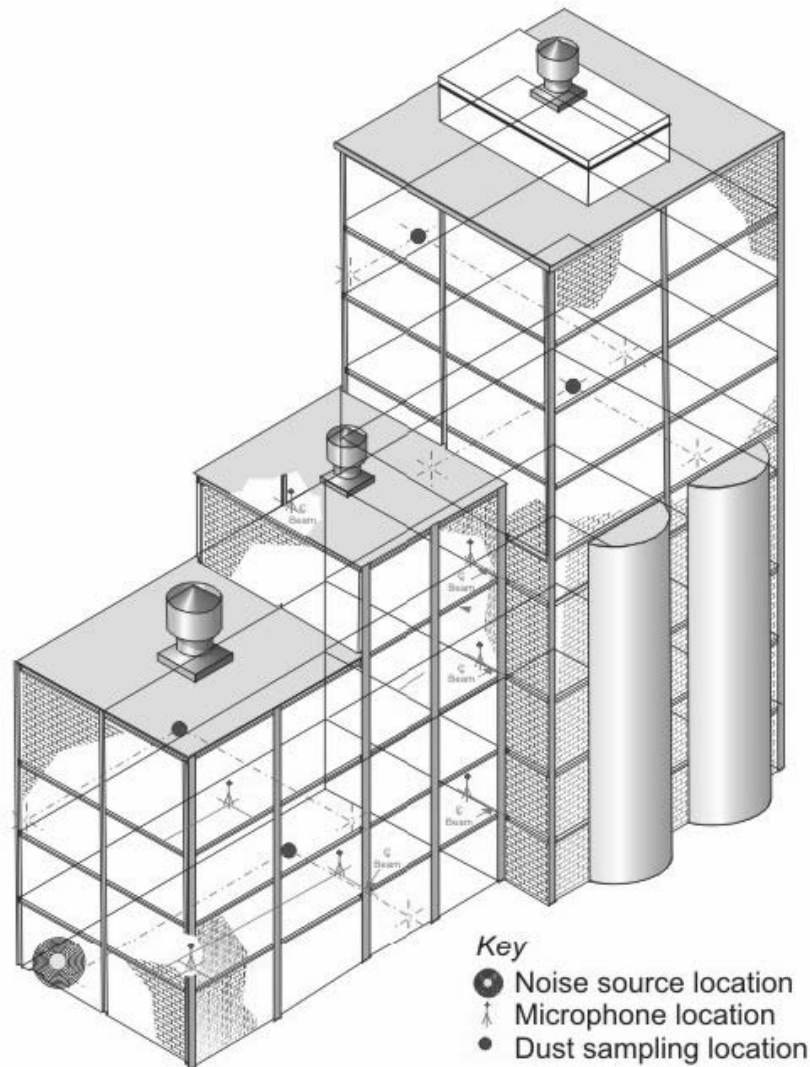

Figure 1.—Dust and noise sampling instrumentation setup at masonry structure No. 1.

## Structure No. 2

Structure No. 2 was a steel beam shell using an open structure design with no walls. Figure 2 shows a monitor being inspected by a researcher at this open structure processing operation. This structure was 46 ft long, 22 ft wide, and approximately 75 ft high. A weather vane directional anemometer located on the very top of the structure was used to record wind direction and speed over the sampling period.

Dust testing was also performed at this facility for 4 days. There were four locations where both gravimetric and RAM-1 respirable dust measurements were obtained. There were three additional locations where only RAM-1 respirable dust measurements were performed. The noise data were once again measured and recorded for a 45-sec time period at various locations throughout the open structure. Because of the difference in the open and closed

structures, the microphones were located in different positions in the open structure compared to structure No. 1. Although the microphones were located in different positions throughout the two structures, the overall distances from the sound source to each sampling location were comparable in both structures. Figure 3 shows the test locations for dust and noise sampling instrumentation. It should be noted that the dust and noise tests were performed during separate time periods at this facility because of scheduling conflicts among the various researchers.

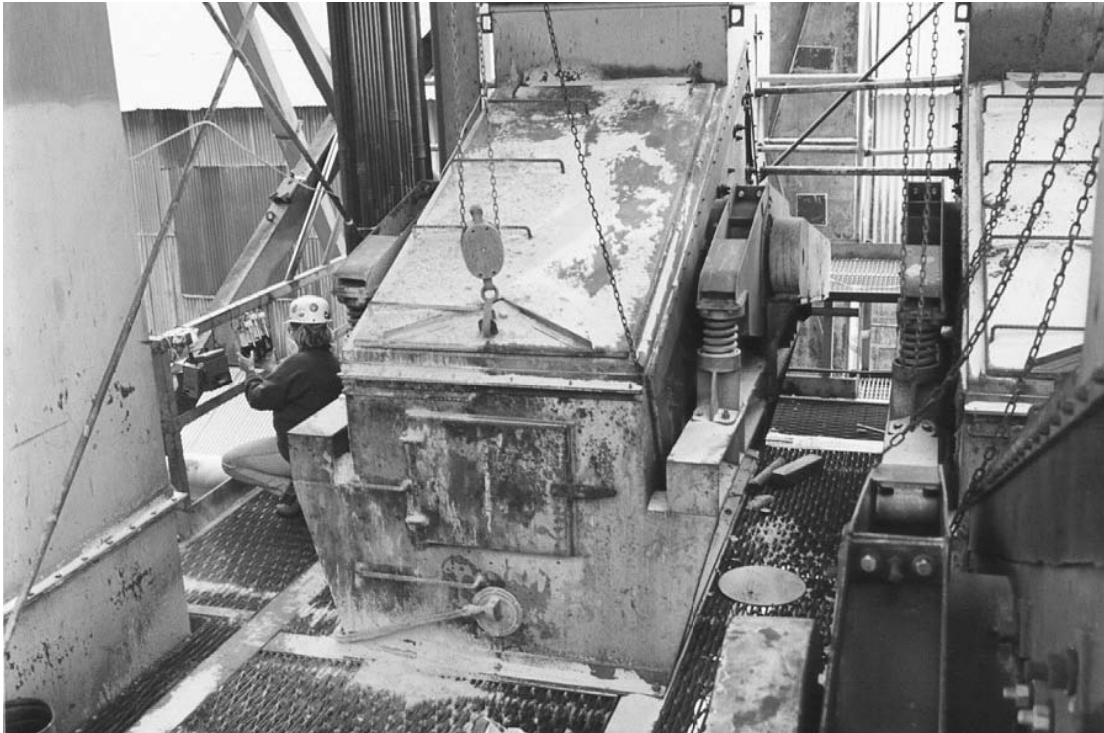

**Figure 2.—A researcher inspects sampling equipment at open structure No. 2.**

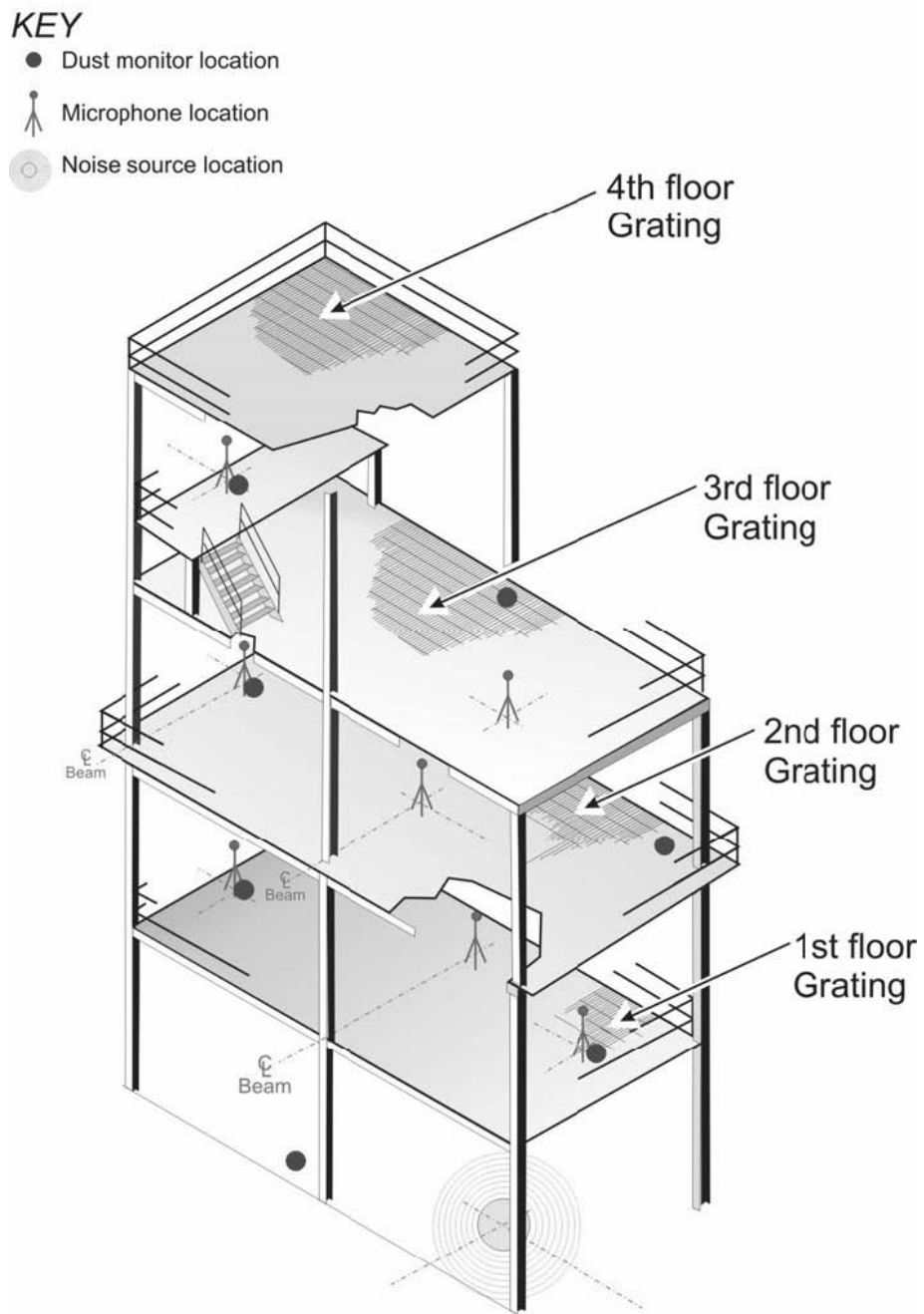

Figure 3.—Dust and noise sampling instrumentation setup at open structure No. 2.

### Structure No. 3

Structure No. 3 was a five-story steel-framed metal-sided building. This building was somewhat unique from the two previous structures in that both product crushing and sizing were performed in the same building. This structure was 130 ft long, 65 ft wide, and 25 ft high. A 15-ft by 15-ft tower extended up out of the center of the structure an additional 22 ft. The volumetric capacity of this building was calculated to be 238,000 ft<sup>3</sup>. Dust testing was performed for 4 days at various sample locations, as shown in Figure 4. The majority of the dust sampling instruments were located toward the eastern side of the building and in the tower section because most of the production activities were in these areas. The western part of the building was mainly an access way for plant personnel and forklifts moving supplies and pallets of bagged product material. There were no noise measurements taken at this structure.

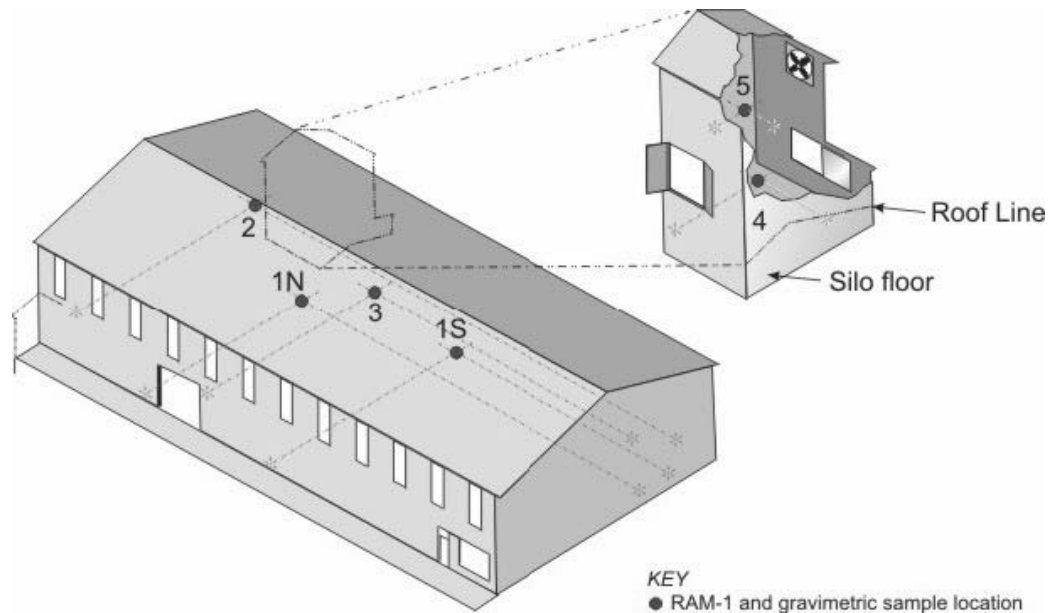

Figure 4.—Dust and noise sampling instrumentation setup at steel-sided structure No. 3.

## RESULTS

### Respirable Dust

To review, structure No. 1 was a masonry structure using the screening technique, structure No. 2 was an open structure also using the screening technique, and structure No. 3 was a steel-sided structure using an air separator technique. Table 1 compares the three structures based on the average respirable dust levels measured with both the RAM-1 and gravimetric sampling instrumentation for 4 days of testing. Once again, the RAM-1 results are based on round-the-clock testing, whereas the gravimetric results are single-shift measurements.

**Table 1.—Average respirable dust concentrations for the three product sizing structures**

Sample location	RAM-1 dust monitor dust concentration, mg/m <sup>3</sup>	Gravimetric dust concentration, mg/m <sup>3</sup>
Structure No. 1 – Masonry:		
1st floor .....	0.06	0.02
3rd floor .....	0.10	0.04
5th floor .....	0.23	0.16
7th floor .....	0.42	0.29
Structure No. 2 – Open design:		
Ground floor .....	0.06	—
1st floor – north .....	0.06	0.02
1st floor – south .....	0.07	—
2nd floor – north .....	0.03	0.03
2nd floor – south .....	0.07	—
3rd floor .....	0.08	0.06
3½ floor .....	0.05	0.04
Structure No. 3 – Steel-sided:		
1st floor – north .....	0.35	0.24
1st floor – south .....	0.45	0.37
2nd floor .....	1.01	0.40
3rd floor .....	2.22	1.81
4th floor .....	3.61	1.78
5th floor .....	2.12	1.57

With any closed-wall structure, there is normally an increase in dust levels as one moves up through the structure. This was the case for structure Nos. 1 and 3 as dust levels generally increased at each level up through the structure. This occurs because either the mechanical or natural ventilation within the structures induces an upward flow convection, which entrains the dust and moves it up through the structure with the ventilating airflow. This occurrence was also identified during field testing of the total mill ventilation technique described earlier.

The one exception to this dust increase was at the fifth-floor sampling location for structure No. 3, as seen in Figure 4. A fan located at the top of the structure pulled a good portion of the supply air from the open door on the opposite side of the tower at the fourth floor. As the air came in from outside and swept across the tower to the fan, it traveled across the fifth-floor dust sampling location. Although this had a positive impact on lowering dust levels at the fifth-floor sample location, this is not an effective ventilation flow pattern for the entire structure. Dust levels below the fifth-floor location were not well ventilated, which caused respirable dust concentrations in this area to climb.

One significant benefit from the open structure design in structure No. 2 was that there was no dust gradient as one moved up through the different floors. Dust levels varied slightly from floor to floor at this open structure, with no consistent pattern. In addition, respirable dust levels were extremely low compared to levels measured at the other two structures. It should be noted that no visible dust plume was ever observed flowing from this open structure during the entire evaluation period. The minimal amount of dust that was not contained by the primary dust control systems at this operation, thus liberated into the air, migrated from the structure based upon the prevailing wind direction and speed. This dust should be quickly diluted to undetectable levels within a close proximity to the structure and should have no impact on other plant personnel, nearby communities, or the environment.

When considering respirable dust levels measured during the 4-day evaluations at each structure, there were two major factors affecting dust generation: (1) hours of operation, and (2) the amount of material processed (production) during the sampling period. Periods of nonproduction were removed from the data and not included in the dust averages for any of the three structures evaluated. Table 2 shows production levels for each day over the sampling period and the total production value for the entire test period. Structure Nos. 1 and 2 had similar production levels for the 4 days of evaluation at 5,437 and 6,905 tons processed, respectively. Both of these production levels were significantly higher than the production level at structure No. 3, in which 160 tons was processed during the evaluation period.

**Table 2.—Production levels for the evaluation period for the three product sizing structures**

Structure	Tonnage				Total
	Day 1	Day 2	Day 3	Day 4	
No. 1: Masonry.....	1,893	1,762	1,278	<sup>1</sup> 504	5,437
No. 2: Open design.....	<sup>1</sup> 660	2,602	2,796	<sup>1</sup> 847	6,905
No. 3: Steel-sided.....	39.1	39.6	39.2	42.6	160.5

<sup>1</sup>Partial day of testing.

In an effort to give a more accurate comparison of the three structures, a normalized dust concentration was calculated for each operation (Table 3). This calculated value provides a dust concentration based on an equivalent production rate for each facility. The results from these normalized calculations further indicate how effective the open structure design was at minimizing respirable dust levels. This comparison shows that respirable dust levels at structure Nos. 1 and 3 were 4.3 and 1,379 times higher than those measured at structure No. 2 when normalized for equivalent production levels.

**Table 3.—Calculated respirable dust concentration per ton of product processed for the three structures evaluated**

Structures	Dust concentration, mg/m <sup>3</sup>	Production rate, tons	Normalized dust concentration, mg/m <sup>3</sup>
No. 1.....	0.20	5,437	3.7 E <sup>-5</sup>
No. 2.....	0.06	6,905	8.7 E <sup>-6</sup>
No. 3.....	1.87	160.5	1.2 E <sup>-2</sup>



It should be noted that part of this study was a ventilation analysis for the walled structures, since ventilation is such a critical component for minimizing respirable dust levels at mineral processing facilities. Tracer gas studies were performed at both structure Nos. 1 and 3 to provide a more in-depth ventilation analysis. Although the results of these ventilation studies will not be presented in this report for purposes of brevity, some of the information learned will be noted in the “Discussion” section.

## Noise

From a noise standpoint, the results of the experiments conducted in structure Nos. 1 and 2 are summarized in Tables 4–5. Octave-band sound pressure level (SPL) data are presented as a function of distance (and location) relative to the noise source located on the ground floor. Data from some of the more distant measurement locations (as shown in Figures 1 and 3) were not used in the final analysis due to background interference. To better visualize trends in the data, SPL data versus distance from the two structures are plotted on a log scale at selected frequencies (125, 1,000, and 4,000 Hz) in Figure 5. In addition, the SPL data have been overlaid with a straight line having a slope of 6 dB per doubling of distance, which is characteristic of a noise source located in a free field.

**Table 4.—Sound pressure levels (in decibels) of structure No. 1: reverberant environment**

Octave-band center frequency, Hz	2nd floor, location No. 3, 28 ft from source	2nd floor, location No. 2, 38 ft from source	3rd floor, location No. 1, 45 ft from source	3rd floor, location No. 2, 60 ft from source	2nd floor, location No. 1, 60 ft from source	4th floor, location No. 2, 68 ft from source	4th floor, location No. 1, 79 ft from source
125.....	84.3	84.8	82.7	81.3	79.3	77.9	77.8
250.....	81.3	82.6	81.4	78.1	78.9	76.7	76.0
500.....	80.7	79.4	78.8	76.3	76.8	77.3	72.9
1,000.....	80.1	77.7	76.6	73.8	73.4	70.9	68.5
2,000.....	77.4	74.8	75.7	70.8	71.2	69.6	65.7
4,000.....	76.3	73.4	72.9	68.5	69.4	66.6	63.6
8,000.....	75.2	71.4	71.9	65.6	66.6	66.7	59.1

**Table 5.—Sound pressure levels (in decibels) of structure No. 2: open environment**

Octave-band center frequency, Hz	2nd floor, location No. 3, 23 ft from source	2nd floor, location No. 2, 27 ft from source	2nd floor, location No. 1, 42 ft from source	3rd floor, location No. 2, 44 ft from source	3rd floor, location No. 1, 56 ft from source
125.....	78.8	78.8	75.4	74.9	74.1
250.....	78.4	78.0	74.1	72.1	72.3
500.....	76.3	75.9	72.3	69.8	69.7
1,000.....	75.1	73.4	71.7	67.6	67.9
2,000.....	74.3	74.6	70.8	66.1	65.6
4,000.....	72.7	73.5	68.0	64.4	62.2
8,000.....	70.5	70.6	64.2	58.2	55.6

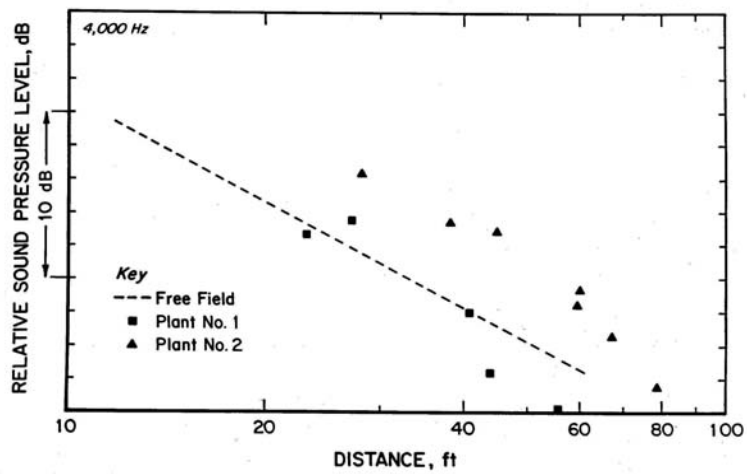
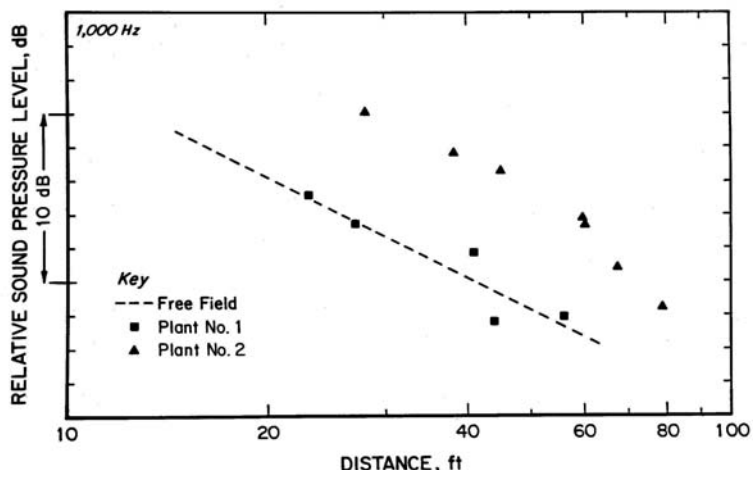
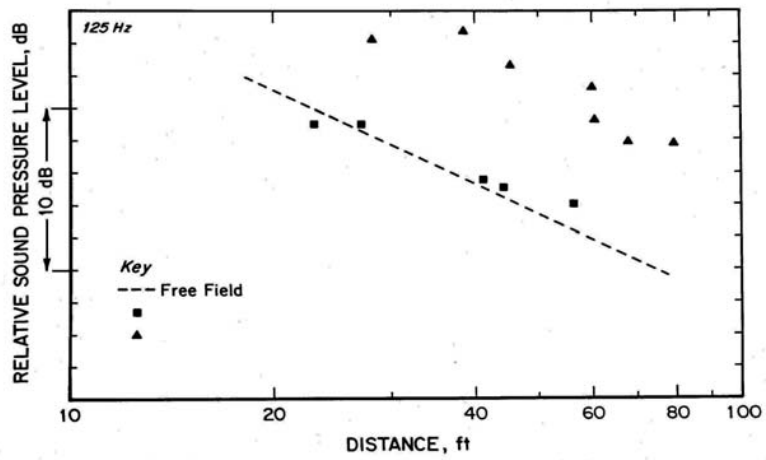

Figure 5.—Sound pressure levels versus distance in structure Nos. 1 and 2.

## DISCUSSION

This report analyzes and compares the differences in respirable dust and noise levels at three silica sand product sizing structures that were each evaluated for 4 days. These facilities are dynamic environments that are constantly changing relative to time. By sampling around the clock, we tried to minimize some of the shift fluctuations and variations. We realize there is a long list of variables that affect the magnitude of dust and noise levels within these structures. Although the information obtained in this study is being used to compare the differences among these facilities, we understand that these results provide only a small picture of the respirable dust and noise levels during the actual test period and that measurements taken during another time would most likely produce different levels.

With this acknowledgement, considering all of the information and data, the most effective structural design of the three product sizing buildings was the open structure design (structure No. 2). Respirable dust concentrations were significantly lower with the open structure design than at the other two facilities because the environment acts as the best source of ventilation to dilute and carry away dust generated and liberated during the product sizing process. Respirable dust levels at structure No. 2 were more than four times lower than those at structure No. 1 when compared with normalized production levels. Both of these plants had similar screening processes, production levels, and overall structural designs.

Respirable dust levels at structure No. 2 were also much lower than those measured at structure No. 3, where product sizing was performed using the air separator technique. Production levels for structure No. 3 were only 2.5% of those for structure No. 2 during this evaluation, yet respirable dust concentrations were 1,379 times higher when the data were normalized for equivalent tonnages.

Although the open design of structure No. 2 was the most effective from a dust standpoint, it is worth evaluating key features in each of the wall structure designs (structure Nos. 1 and 3). With regard to structure No. 1, respirable dust levels were relatively low considering that the building was, for the most part, naturally ventilated. A tracer gas test at this facility indicated that there was an effective flow pattern up through the structure during the test. The problem with natural ventilation is that it changes significantly as the outside-to-inside air temperature differential changes over time. These changes can be substantial when one considers the variation in temperatures throughout the course of a year.

An interesting event was identified during the evaluation of structure No. 1 that supports the effectiveness of an open structure design. During the original tracer gas test, a problem occurred that caused the test to be invalid and necessitated that it be repeated some 2½ months later. During this followup test, it was decided to operate the dust monitoring instruments concurrently to correlate the results of the tracer gas survey with respirable dust concentrations throughout the structure. In fact, the results from this final day of testing replaced the original fourth-day evaluation because it was believed to be a much more representative sample since there was a significant amount of downtime during the original last-day test.

During this retest, one significant change was that a large bay door on the fifth floor of structure No. 1 was open. This open door provided a significant amount of natural ventilation to the structure and significantly lowered the dust levels in this area of the building. With this open bay door, respirable dust levels were 59.3% and 70.9% lower at the fifth- and seventh-floor sample locations, respectively, compared to the first 3 days of testing. This also supports the

impact that a more open design can have on lowering respirable dust levels in a portion of the structure, indicating the potential effectiveness of modifying existing structures.

Two possible ways to lower respirable dust levels at structure No. 1 are to (1) install powered exhaust fans in the upper portion of the building, as discussed in the total mill ventilation research [Cecala et al. 1993], and (2) provide a more open structure design, as evidenced by the open bay door during the retest of the tracer gas study. Exhaust fans would provide a consistent ventilation rate to the structure and thus reduce respirable dust levels. Unlike natural ventilation, which can be significantly affected by outside air temperature changes, the benefit of a mechanical ventilation system is its consistency throughout the year. A more open design would require removing portions of the walls of the structure. When considering both of these options, it seems that installing mechanical fans would be more appropriate and easily accomplished.

With regard to structure No. 3 (steel-sided), the majority of dust liberated within the structure was drawn up through the tower portion of the building, thus concentrating dust levels in this area of the structure. Dust levels ranged from  $0.35 \text{ mg/m}^3$  on the first floor to  $3.61 \text{ mg/m}^3$  on the fourth floor. A better approach to ventilate this structure and lower overall dust levels would have been to install two or three roof-powered exhausters positioned equally along the peak of the structure. This would have drawn the dust more equally from the building and not allowed an accumulation of high dust concentrations in the tower section of the structure. It would also be beneficial to close the door across from the fifth floor sampling location and have an air supply inlet at the base of the tower structure. This would provide for a more uniform flow through the tower portion of the building.

From a noise standpoint, the SPL data measured during the experiments at the two screening tower facilities show that the sound field intensity in both structures decreases with increasing distance from the source. The open structure design (structure No. 2) appears to approximate an acoustic free-field environment. The level of the sound field measured in the reverberant environment of structure No. 1 tends to be about 5–8 dB higher than the level in structure No. 2 at comparable distances from the source.

Examining the sound field measured in structure No. 1 shows that the sound level, after an initial increase near the source, falls off with increasing distance much like in the free-field environment. The behavior of the sound field is qualitatively consistent with the results of previous studies to predict the propagation of sound in a fitted room [Hodgson 1990]. In general, when a large number of machines or fittings are distributed in an enclosed space, such as a plant or factory, the resulting noise level is higher near the source, but lower at greater distances from the source. The fittings serve to positively influence the absorption in the space by creating a more diffuse sound field with many opportunities for the sound field to interact with absorbent surfaces.

As the results have shown, respirable dust and noise levels were significantly lower in the open wall structure than in either of the two walled structures. It must be noted that with any open wall structure, there are a number of issues that have to be addressed that are not normal concerns with walled structures. First, great effort must be made to provide safety railings and guards to minimize the potential for any personnel falling from the structure. Another problem is the protection of equipment and personnel from environmental elements such as rain, snow, sleet, and hail. It seems that this technique would be better suited for southern climates, although the open structure design evaluated in this study was located in central Pennsylvania, which has relatively cold winters. This plant has been in operation for many years and has been

very successful with the open structure design. It must also be noted that there was no water application within this structure, which eliminated the concern for freeze-up problems during periods of below-freezing temperatures.

Another factor to keep in mind when considering building a new structure or modifying an existing structure to a more open design is the proximity of the building to residential dwellings or other businesses. This open structure should only be considered when there is a substantial buffer zone around the building unless other solutions can be designed to overcome this, such as walls built along highways to minimize noise levels to adjacent dwellings.

Still another factor to consider is the number of variations in an open structure design. Structure No. 2 in this study was a totally open design. One modification that could be incorporated into the design to protect the structure from inclement weather would be a roof with a sufficient overhang. Figure 6 shows a conceptual drawing of a typical walled processing facility, then an identically sized facility with an open design structure and a roof. A roof would provide more protection from the natural elements than the totally open design.

While looking for similar types of research studies performed during the background information search, very little information was found that was applicable to the study described in this report. When considering the ventilation within a building or structure, the two main reference books most often used are *Industrial Ventilation: A Manual of Recommended Practice*, published by the American Conference of Governmental Industrial Hygienists [ACGIH 2001], and the *ASHRAE Fundamentals Handbook*, published by the American Society of Heating, Refrigerating and Air-Conditioning Engineers, Inc. [ASHRAE 1989]. Both publications provide a wealth of information to design engineers, but neither discusses the open structure design. The *ASHRAE Handbook* identifies a number of aspects that are applicable in a section entitled "Natural Ventilation Guidelines," which appears in chapter 23, "Infiltration and Ventilation." This section discusses the importance of designing structures with regard to topography, landscaping, surrounding buildings, and natural wind directions to take advantage of natural breezes to ventilate buildings.

It must be noted that if an open structure design is being considered, it should be viewed as a secondary design. The first approach to lower dust and noise exposures to workers is by properly designed and installed primary dust and noise control techniques. From a dust control standpoint, this means having a good primary dust control plan that minimizes dust generation and liberation and captures major dust sources at their point of origin before they are allowed to flow out into the plant, contaminating plant personnel. From a noise standpoint, this means using equipment that has been designed with noise-dampening components and providing acoustical dampening material when applicable around significant noise-producing equipment and functions. It is also important to have a good maintenance program to constantly repair equipment, as well as a good housekeeping program. The open structure design should then be evaluated as a secondary method to further improve health concerns at mineral processing operations. In this manner, the open design would be very similar to the total mill ventilation system in that it has the potential to be a global approach to lower dust and noise levels throughout an entire building or structure.

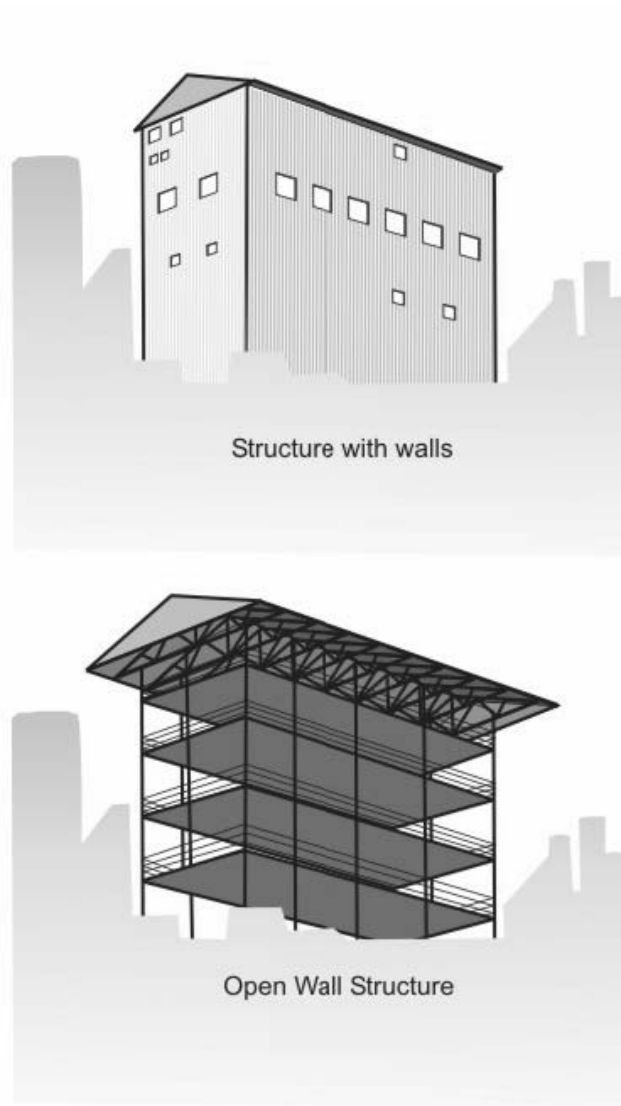

**Figure 6.—Comparison of walled and open structure design for same size mineral processing building.**

## **CONCLUSIONS**

This research determined that the open structure design for mineral processing operations was superior to walled structures when considering both interior dust and noise levels. From a dust standpoint, the open structure was beneficial because there was no dust gradient when moving up through the building. From a noise standpoint, the open structure was beneficial because it eliminated the reverberation effects of sound waves bouncing off the walls. In the open structure design, the natural environment acts as an effective method of diluting and carrying away dust generated and liberated during the product sizing process, as well as dampening the sound waves as they travel out from the structure. Nevertheless, the open structure design should be viewed as a secondary control technique for both dust and noise. Operations must have effective primary dust control techniques to capture and contain dust at the

point of generation. The most widely used method for these types of operations is capturing the dust sources with negative ventilation and filtering the dust through a collector device. No dust plume should ever be visible at an open structure design. Also, if dust plumes are visibly flowing from an open structure, then better primary dust control measures should be implemented. Similarly, major noise sources should be dealt with by using engineering controls to eliminate or dampen significant sources. Engineering out the primary noise sources with equipment is the primary avenue for lowering noise levels. It should be noted that some state and local governments may prohibit the release of dust or noise from an open structure, even though it should be extremely minimal.

This research effort has highlighted some of the advantages of an open structure design and why it should be considered in some applications by designers and engineering companies when building new structures. It is obvious that the open structure design will be more cost-effective because there would be less material and construction costs. Some companies may also want to consider modifying their existing structures with a more open design to further reduce dust and noise levels. If operations are considering the open structure design, dust and noise controls should be impeccable to minimize any plant, community, or environmental impact.

## REFERENCES

- ACGIH [2001]. Industrial ventilation: a manual of recommended practice. 24th ed. Cincinnati, OH: American Conference of Governmental Industrial Hygienists.
- ASHRAE [1989]. ASHRAE handbook: fundamentals. Inch-pound (I-P) ed. Atlanta, GA: American Society of Heating, Refrigerating and Air-Conditioning Engineers, Inc.
- Cecala AB, Covelli A [1991]. Automation to control silica dust during the pallet loading process. *Min Eng* 43(12):1440–1444.
- Cecala AB, Klinowski GW, Thimons, ED [1993]. Reducing respirable dust concentrations at mineral processing facilities using total mill ventilation systems. Pittsburgh, PA: U.S. Department of the Interior, Bureau of Mines, RI 9469.
- Cecala AB, Timko RJ, Thimons ED [2000]. Methods to lower the dust exposure of bag machine operators and bag stackers. *Appl Occup Environ Hyg* 15(10):751–765.
- Cecala AB, Volkwein JC, Thimons ED [1984]. New bag nozzle to reduce dust from fluidized air bag machines. Pittsburgh, PA: U.S. Department of the Interior, Bureau of Mines, RI 8886. NTIS No. PB 84–224484.
- CFR. Code of federal regulations. Washington, DC: U.S. Government Printing Office, Office of the Federal Register.
- Hennings K [1980]. Noise abatement of vibrating screens: using nonmetallic decks and vibration treatments. Allis-Chalmers Corp. U.S. Bureau of Mines contract No. H0387018. NTIS No. PB 82–251919.
- Hnizdo E, Sluis-Cremer GK [1991]. Silica exposure, silicosis, and lung cancer: a mortality study of South African gold miners. *Br J Ind Med* 48(1):53–60.
- Hodgson M [1990]. On the accuracy of models predicting sound propagation in fitted rooms. *J Acoust Soc Am* 88(2):871–878.
- Kreiss K, Zhen B [1996]. Risk of silicosis in a Colorado mining community. *Am J Ind Med* 30(5):529–539.
- Ng TP, Chan SL [1994]. Quantitative relations between silica exposure and development of radiological small opacities in granite workers. *Ann Occup Hyg* 38(Suppl 1):857–863.

NIOSH [1999]. Preventing hearing loss among miners. Pittsburgh, PA: U.S. Department of Health and Human Services, Public Health Service, Centers for Disease Control and Prevention, National Institute for Occupational Safety and Health, *Min Saf & Health Focus 4(1)*: 1–3.

Pokora RJ, Bobick TG, Muldoon TL [1984]. Retrofit noise control modifications for crushing and screening equipment in the nonmetallic mining industry: an applications manual. Pittsburgh, PA: U.S. Department of the Interior, Bureau of Mines, IC 8975. NTIS No. PB 84–213925.

Rice C, Herring RL [1995]. The North Carolina dusty trades database: a resource for assessment of silica exposure since 1935. *Appl Occup Environ Hyg 10(12)*:1005–1008.

Rubin MN, Thompson AR, Cleworth RK, Olson RF [1982]. Noise control techniques for the design of coal preparation plants. Roberts & Schaefer Co. and Bolt, Beranek, and Newman, Inc. U.S. Bureau of Mines contract No. J0100018. NTIS No. PB 84–166172.

Steenland K, Brown D [1995]. Mortality study of gold miners exposed to silica and nonasbestiform amphibole minerals: an update with 14 more years of followup. *Am J Ind Med 27(2)*:217–229.

Stephenson MR, Merry CJ [1998]. Hearing loss among miners and measures to protect hearing. *Joseph A. Holmes Saf Assoc Bull Oct*:3–5.

U.S. Bureau of Mines [1983]. Retrofit noise control techniques for crushing and screening plants. Pittsburgh, PA: U.S. Department of the Interior, Bureau of Mines, *Technology News 179*.

Volkwein JC, Gaynor RD [1985]. Dust control in bag-filling operations. Pittsburgh, PA: U.S. Department of the Interior, Bureau of Mines, IC 9005. NTIS No. PB 85–198943.

Watts WF Jr., Parker DR [1995]. Quartz exposure trends in metal and nonmetal mining. *Appl Occup Environ Hyg 10(12)*:1009–1018.

Williams KL, Timko RJ [1984]. Performance evaluation of a real-time aerosol monitor. Pittsburgh, PA: U.S. Department of the Interior, Bureau of Mines, IC 8968. NTIS No. PB 84–199710.





*Delivering on the Nation's promise:  
Safety and health at work for all people  
through research and prevention*

To receive documents or more information about occupational safety and health topics,  
contact NIOSH at

1-800-35-NIOSH (1-800-356-4674)

Fax: 513-533-8573

E-mail: [pubstaff@cdc.gov](mailto:pubstaff@cdc.gov)

or visit the NIOSH Web site at [www.cdc.gov/niosh](http://www.cdc.gov/niosh)

**DHHS (NIOSH) Publication No. 2007-101**

**SAFER • HEALTHIER • PEOPLE™**