

TOXICOLOGICAL PROFILE FOR
***n*-HEXANE**

U.S. DEPARTMENT OF HEALTH AND HUMAN SERVICES
Public Health Service
Agency for Toxic Substances and Disease Registry

July 1999

DISCLAIMER

The use of company or product name(s) is for identification only and does not imply endorsement by the Agency for Toxic Substances and Disease Registry.

UPDATE STATEMENT

A draft Toxicological Profile for *n*-Hexane was released in September 1997. This edition supersedes any previously released draft or final profile.

Toxicological profiles are revised and republished as necessary, but no less than once every three years. For information regarding the update status of previously released profiles, contact ATSDR at:

Agency for Toxic Substances and Disease Registry
Division of Toxicology/Toxicology Information Branch
1600 Clifton Road NE, E-29
Atlanta, Georgia 30333

FOREWORD

This toxicological profile is prepared in accordance with guidelines* developed by the Agency for Toxic Substances and Disease Registry (ATSDR) and the Environmental Protection Agency (EPA). The original guidelines were published in the *Federal Register* on April 17, 1987. Each profile will be revised and republished as necessary.

The ATSDR toxicological profile succinctly characterizes the toxicologic and adverse health effects information for the hazardous substance described therein. Each peer-reviewed profile identifies and reviews the key literature that describes a hazardous substance's toxicologic properties. Other pertinent literature is also presented, but is described in less detail than the key studies. The profile is not intended to be an exhaustive document; however, more comprehensive sources of specialty information are referenced.

The focus of the profiles is on health and toxicologic information; therefore, each toxicological profile begins with a public health statement that describes, in nontechnical language, a substance's relevant toxicological properties. Following the public health statement is information concerning levels of significant human exposure and, where known, significant health effects. The adequacy of information to determine a substance's health effects is described in a health effects summary. Data needs that are of significance to protection of public health are identified by ATSDR and EPA.

Each profile includes the following:

- (A) The examination, summary, and interpretation of available toxicologic information and epidemiologic evaluations on a hazardous substance to ascertain the levels of significant human exposure for the substance and the associated acute, subacute, and chronic health effects;
- (B) A determination of whether adequate information on the health effects of each substance is available or in the process of development to determine levels of exposure that present a significant risk to human health of acute, subacute, and chronic health effects; and
- (C) Where appropriate, identification of toxicologic testing needed to identify the types or levels of exposure that may present significant risk of adverse health effects in humans.

The principal audiences for the toxicological profiles are health professionals at the Federal, State, and local levels; interested private sector organizations and groups; and members of the public.

This profile reflects ATSDR's assessment of all relevant toxicologic testing and information that has been peer-reviewed. Staff of the Centers for Disease Control and Prevention and other Federal scientists have also reviewed the profile. In addition, this profile has been peer-reviewed by a nongovernmental panel and was made available for public review. Final responsibility for the contents and views expressed in this toxicological profile resides with ATSDR.



Jeffrey P. Koplan, M.D., M.P.H.
Administrator
Agency for Toxic Substances and
Disease Registry

*Legislative Background

The toxicological profiles are developed in response to the Superfund Amendments and Reauthorization Act (SARA) of 1986 (Public Law 99-499) which amended the Comprehensive Environmental Response, Compensation, and Liability Act of 1980 (CERCLA or Superfund). This public law directed ATSDR to prepare toxicological profiles for hazardous substances most commonly found at facilities on the CERCLA National Priorities List and that pose the most significant potential threat to human health, as determined by ATSDR and the EPA. The availability of the revised priority list of 275 hazardous substances was announced in the *Federal Register* on November 17, 1997 (62 FR 61332). For prior versions of the list of substances, see *Federal Register* notices dated April 29, 1996 (61 FR 18744); April 17, 1987 (52 FR 12866); October 20, 1988 (53 FR 41280); October 26, 1989 (54 FR 43619); October 17, 1990 (55 FR 42067); October 17, 1991 (56 FR 52166); October 28, 1992 (57 FR 48801); and February 28, 1994 (59 FR 9486). Section 104(i)(3) of CERCLA, as amended, directs the Administrator of ATSDR to prepare a toxicological profile for each substance on the list.

QUICK REFERENCE FOR HEALTH CARE PROVIDERS

Toxicological Profiles are a unique compilation of toxicological information on a given hazardous substance. Each profile reflects a comprehensive and extensive evaluation, summary, and interpretation of available toxicologic and epidemiologic information on a substance. Health care providers treating patients potentially exposed to hazardous substances will find the following information helpful for fast answers to often-asked questions.

Primary Chapters/Sections of Interest

Chapter 1: Public Health Statement: The Public Health Statement can be a useful tool for educating patients about possible exposure to a hazardous substance. It explains a substance's relevant toxicologic properties in a nontechnical, question-and-answer format, and it includes a review of the general health effects observed following exposure.

Chapter 2: Health Effects: Specific health effects of a given hazardous compound are reported by *route of exposure*, by *type of health effect* (death, systemic, immunologic, reproductive), and by *length of exposure* (acute, intermediate, and chronic). In addition, both human and animal studies are reported in this section.

NOTE: Not all health effects reported in this section are necessarily observed in the clinical setting. Please refer to the Public Health Statement to identify general health effects observed following exposure.

Pediatrics: Four new sections have been added to each Toxicological Profile to address child health issues:

- Section 1.6** **How Can (Chemical X) Affect Children?**
- Section 1.7** **How Can Families Reduce the Risk of Exposure to (Chemical X)?**
- Section 2.6** **Children's Susceptibility**
- Section 5.6** **Exposures of Children**

Other Sections of Interest:

- Section 2.7** **Biomarkers of Exposure and Effect**
 - Section 2.10** **Methods for Reducing Toxic Effects**
-

ATSDR Information Center

Phone: 1-888-42-ATSDR
or 404-639-6357

E-mail: atsdric@cdc.gov

Fax: 404-639-6359

Internet: <http://www.atsdr.cdc.gov/>

The following additional material can be ordered through the ATSDR Information Center:

Case Studies in Environmental Medicine: Taking an Exposure History—The importance of taking an exposure history and how to conduct one are described, and an example of a thorough exposure history is provided. Other case studies of interest include *Reproductive and Developmental Hazards*; *Skin Lesions and Environmental Exposures*; *Cholinesterase-Inhibiting Pesticide Toxicity*; and numerous chemical-specific case studies.

Managing Hazardous Materials Incidents is a three-volume set of recommendations for on-scene (prehospital) and hospital medical management of patients exposed during a hazardous materials incident. Volumes I and II are planning guides to assist first responders and hospital emergency department personnel in planning for incidents that involve hazardous materials. Volume III—*Medical Management Guidelines for Acute Chemical Exposures*—is a guide for health care professionals treating patients exposed to hazardous materials.

Fact Sheets (ToxFAQs) provide answers to frequently asked questions about toxic substances.

Other Agencies and Organizations

The National Center for Environmental Health (NCEH) focuses on preventing or controlling disease, injury, and disability related to the interactions between people and their environment outside the workplace. *Contact:* NCEH, Mailstop F-29, 4770 Buford Highway, NE, Atlanta, GA 30341-3724 • Phone: 770-488-7000 • FAX: 770-488-7015.

The National Institute for Occupational Safety and Health (NIOSH) conducts research on occupational diseases and injuries, responds to requests for assistance by investigating problems of health and safety in the workplace, recommends standards to the Occupational Safety and Health Administration (OSHA) and the Mine Safety and Health Administration (MSHA), and trains professionals in occupational safety and health. *Contact:* NIOSH, 200 Independence Avenue, SW, Washington, DC 20201 • Phone: 800-356-4674 or NIOSH Technical Information Branch, Robert A. Taft Laboratory, Mailstop C-19, 4676 Columbia Parkway, Cincinnati, OH 45226-1998 • Phone: 800-35-NIOSH.

The National Institute of Environmental Health Sciences (NIEHS) is the principal federal agency for biomedical research on the effects of chemical, physical, and biologic environmental agents on human health and well-being. *Contact:* NIEHS, PO Box 12233, 104 T.W. Alexander Drive, Research Triangle Park, NC 27709 • Phone: 919-541-3212.

Referrals

The Association of Occupational and Environmental Clinics (AOEC) has developed a network of clinics in the United States to provide expertise in occupational and environmental issues. *Contact:* AOEC, 1010 Vermont Avenue, NW, #513, Washington, DC 20005 • Phone: 202-347-4976 • FAX: 202-347-4950 • e-mail: aoec@dgs.dgsys.com • AOEC Clinic Director: <http://occ-env-med.mc.duke.edu/oem/aoec.htm>.

The American College of Occupational and Environmental Medicine (ACOEM) is an association of physicians and other health care providers specializing in the field of occupational and environmental medicine. *Contact:* ACOEM, 55 West Seegers Road, Arlington Heights, IL 60005 • Phone: 847-228-6850 • FAX: 847-228-1856.

CONTRIBUTORS

CHEMICAL MANAGER/AUTHOR:

M. Olivia Harris, M.A.
ATSDR, Division of Toxicology, Atlanta, GA

James Corcoran, Ph.D.
Research Triangle Institute, Research Triangle Park, NC

THE PROFILE HAS UNDERGONE THE FOLLOWING ATSDR INTERNAL REVIEWS:

1. **Health Effects Review.** The Health Effects Review Committee examines the health effects chapter of each profile for consistency and accuracy in interpreting health effects and classifying end points.
2. **Minimal Risk Level Review.** The Minimal Risk Level Workgroup considers issues relevant to substance-specific minimal risk levels (MRLs), reviews the health effects database of each profile, and makes recommendations for derivation of MRLs.
3. **Data Needs Review.** The Research Implementation Branch reviews data needs sections to assure consistency across profiles and adherence to instructions in the Guidance.

PEER REVIEW

A peer review panel was assembled for *n*-hexane. The panel consisted of the following members:

1. Dr. Martin Alexander, Professor, Cornell University, 708 Bradfield Hall, Ithaca, NY 14853;
2. Dr. Carson C. Conaway, Research Scientist, American Health Foundation, 1 Dana Road, Valhalla, NY 10595;
3. Dr. Ryan Dupont, Professor, Department of Civil and Environmental Engineering, Utah State University, Logan, UT 84322; and
4. Dr. Robert Feldman, Professor and Chairman, Neurology Department, Boston University Medical School, 80 E. Concord St., Boston, MA 02118.

These experts collectively have knowledge of *n*-hexane's physical and chemical properties, toxicokinetics, key health end points, mechanisms of action, human and animal exposure, and quantification of risk to humans. All reviewers were selected in conformity with the conditions for peer review specified in Section 104(i)(13) of the Comprehensive Environmental Response, Compensation, and Liability Act, as amended.

Scientists from the Agency for Toxic Substances and Disease Registry (ATSDR) have reviewed the peer reviewers' comments and determined which comments will be included in the profile. A listing of the peer reviewers' comments not incorporated in the profile, with a brief explanation of the rationale for their exclusion, exists as part of the administrative record for this compound. A list of databases reviewed and a list of unpublished documents cited are also included in the administrative record.

The citation of the peer review panel should not be understood to imply its approval of the profile's final content. The responsibility for the content of this profile lies with the ATSDR.

CONTENTS

FOREWORD	v
QUICK REFERENCE FOR HEALTH CARE PROVIDERS	vii
CONTRIBUTORS	ix
PEER REVIEW	xi
LIST OF FIGURES	xvii
LIST OF TABLES	xix
1. PUBLIC HEALTH STATEMENT	1
1.1 WHAT IS <i>n</i> -HEXANE?	1
1.2 WHAT HAPPENS TO <i>n</i> -HEXANE WHEN IT ENTERS THE ENVIRONMENT?	2
1.3 HOW MIGHT I BE EXPOSED TO <i>n</i> -HEXANE?	3
1.4 HOW CAN <i>n</i> -HEXANE ENTER AND LEAVE MY BODY?	4
1.5 HOW CAN <i>n</i> -HEXANE AFFECT MY HEALTH?	4
1.6 HOW CAN <i>n</i> -HEXANE AFFECT CHILDREN?	6
1.7 HOW CAN FAMILIES REDUCE THE RISK OF EXPOSURE TO <i>n</i> -HEXANE?	7
1.8 IS THERE A MEDICAL TEST TO DETERMINE WHETHER I HAVE BEEN EXPOSED TO <i>n</i> -HEXANE?	8
1.9 WHAT RECOMMENDATIONS HAS THE FEDERAL GOVERNMENT MADE TO PROTECT HUMAN HEALTH?	8
1.10 WHERE CAN I GET MORE INFORMATION?	9
2. HEALTH EFFECTS	11
2.1 INTRODUCTION	11
2.2 DISCUSSION OF HEALTH EFFECTS BY ROUTE OF EXPOSURE	11
2.2.1 Inhalation Exposure	13
2.2.1.1 Death	13
2.2.1.2 Systemic Effects	14
2.2.1.3 Immunological and Lymphoreticular Effects	37
2.2.1.4 Neurological Effects	37
2.2.1.5 Reproductive Effects	52
2.2.1.6 Developmental Effects	54
2.2.1.7 Genotoxic Effects	57
2.2.1.8 Cancer	58
2.2.2 Oral Exposure	58
2.2.2.1 Death	58
2.2.2.2 Systemic Effects	59
2.2.2.3 Immunological and Lymphoreticular Effects	65
2.2.2.4 Neurological Effects	65
2.2.2.5 Reproductive Effects	66
2.2.2.6 Developmental Effects	67

2.2.2.7	Genotoxic Effects	68
2.2.2.8	Cancer	68
2.2.3	Dermal Exposure	68
2.2.3.1	Death	68
2.2.3.2	Systemic Effects	68
2.2.3.3	Immunological and Lymphoreticular Effects	70
2.2.3.4	Neurological Effects	70
2.2.3.5	Reproductive Effects	70
2.2.3.6	Developmental Effects	70
2.2.3.7	Genotoxic Effects	70
2.2.3.8	Cancer	71
2.3	TOXICOKINETICS	71
2.3.1	Absorption	71
2.3.1.1	Inhalation Exposure	71
2.3.1.2	Oral Exposure	72
2.3.1.3	Dermal Exposure	73
2.3.2	Distribution	73
2.3.2.1	Inhalation Exposure	74
2.3.2.2	Oral Exposure	75
2.3.2.3	Dermal Exposure	75
2.3.3	Metabolism	75
2.3.4	Elimination and Excretion	82
2.3.4.1	Inhalation Exposure	82
2.3.4.2	Oral Exposure	82
2.3.4.3	Dermal Exposure	82
2.3.5	Physiologically based Pharmacokinetic (PBPK)/Pharmacodynamic (PD) Models	83
2.3.5.1	Summary of PBPK Models	84
2.3.5.2	<i>n</i> -Hexane PBPK Model Comparison	84
2.3.5.3	Discussion of Models	86
2.4	MECHANISMS OF ACTION	90
2.4.1	Pharmacokinetic Mechanisms	90
2.4.2	Mechanisms of Toxicity	94
2.4.3	Animal-to-Human Extrapolations	98
2.5	RELEVANCE TO PUBLIC HEALTH	98
2.6	CHILDREN'S SUSCEPTIBILITY	120
2.7	BIOMARKERS OF EXPOSURE AND EFFECT	123
2.7.1	Biomarkers Used to Identify or Quantify Exposure to <i>n</i> -Hexane	124
2.7.2	Biomarkers Used to Characterize Effects Caused by <i>n</i> -Hexane	126
2.8	INTERACTIONS WITH OTHER CHEMICALS	127
2.9	POPULATIONS THAT ARE UNUSUALLY SUSCEPTIBLE	130
2.10	METHODS FOR REDUCING TOXIC EFFECTS	130
2.10.1	Reducing Peak Absorption Following Exposure	131
2.10.2	Reducing Body Burden	131
2.10.3	Interfering with the Mechanism of Action for Toxic Effects	131
2.11	ADEQUACY OF THE DATABASE	132
2.11.1	Existing Information on Health Effects of <i>n</i> -Hexane	132
2.11.2	Identification of Data Needs	132
2.11.4	Ongoing Studies	145

3. CHEMICAL AND PHYSICAL INFORMATION	147
3.1 CHEMICAL IDENTITY	147
3.2 PHYSICAL AND CHEMICAL PROPERTIES	147
4. PRODUCTION, IMPORT/EXPORT, USE, AND DISPOSAL	151
4.1 PRODUCTION	151
4.2 IMPORT/EXPORT	153
4.3 USE	153
4.4 DISPOSAL	155
5. POTENTIAL FOR HUMAN EXPOSURE	157
5.1 OVERVIEW	157
5.2 RELEASES TO THE ENVIRONMENT	157
5.2.1 Air	163
5.2.2 Water	164
5.2.3 Soil	164
5.3 ENVIRONMENTAL FATE	165
5.3.1 Transport and Partitioning	165
5.3.2 Transformation and Degradation	166
5.3.2.1 Air	166
5.3.2.2 Water	166
5.3.2.3 Sediment and Soil	168
5.4 LEVELS MONITORED OR ESTIMATED IN THE ENVIRONMENT	168
5.4.1 Air	170
5.4.2 Water	172
5.4.3 Sediment and Soil	172
5.4.4 Other Environmental Media	173
5.5 GENERAL POPULATION AND OCCUPATIONAL EXPOSURE	174
5.6 EXPOSURES OF CHILDREN	175
5.7 POPULATIONS WITH POTENTIALLY HIGH EXPOSURES	176
5.8 ADEQUACY OF THE DATABASE	177
5.8.1 Identification of Data Needs	177
5.8.2 Ongoing Studies	180
6. ANALYTICAL METHODS	181
6.1 BIOLOGICAL SAMPLES	181
6.2 ENVIRONMENTAL SAMPLES	184
6.3 ADEQUACY OF THE DATABASE	189
6.3.1 Identification of Data Needs	189
6.3.2 Ongoing Studies	191
7. REGULATIONS AND ADVISORIES	193
8. REFERENCES	197
9. GLOSSARY	221

APPENDICES

A. ATSDR MINIMAL RISK LEVELS AND WORKSHEETS A-1

B. USER'S GUIDE B-1

C. ACRONYMS, ABBREVIATIONS, AND SYMBOLS C-1

LIST OF FIGURES

2-1	Levels of Significant Exposure to <i>n</i> -Hexane—Inhalation	26
2-2	Levels of Significant Exposure to <i>n</i> -Hexane—Oral	63
2-3	Proposed Scheme for the Metabolism of <i>n</i> -Hexane	76
2-4	Conceptual Representation of a Physiologically Based Pharmacokinetic (PBPK) Model for a Hypothetical Chemical Substance	85
2-5	Perbellini PBPK Model	87
2-6	Fisher PBPK Model	90
2-7	Reaction of 2,5-Hexanedione with Protein	97
2-8	Existing Information on Health Effects of <i>n</i> -Hexane	133
5-1	Frequency of NPL Sites with <i>n</i> -Hexane Contamination	158
5-2	Degradation of <i>n</i> -Hexane in Air by Free Radicals	167
5-3	Aerobic Biodegradation of <i>n</i> -Hexane in Sediment and Soil	169

LIST OF TABLES

2-1	Levels of Significant Exposure to <i>n</i> -Hexane—Inhalation	15
2-2	Levels of Significant Exposure to <i>n</i> -Hexane—Oral	60
2-3	Levels of Significant Exposure to <i>n</i> -Hexane—Dermal	69
2-4	Parameters Used in the Perbellini PBPK Model for <i>n</i> -Hexane	88
2-5	Parameters Used in the Fisher PBPK Model for <i>n</i> -Hexane	91
2-6	<i>In Vivo</i> Genotoxicity of <i>n</i> -Hexane	115
2-7	<i>In Vitro</i> Genotoxicity of <i>n</i> -Hexane	116
3-1	Chemical Identity of <i>n</i> -Hexane	148
3-2	Physical and Chemical Properties of <i>n</i> -Hexane	149
4-1	Facilities That Manufacture or Process <i>n</i> -Hexane	152
5-1	Releases to the Environment from Facilities That Manufacture or Process <i>n</i> -Hexane	159
5-2	Demand Patterns for Major Petroleum Products (1992)	162
6-1	Analytical Methods for Determining <i>n</i> -Hexane in Biological Samples	182
6-2	Analytical Methods for Determining Biomarkers of <i>n</i> -Hexane in Biological Samples	185
6-3	Analytical Methods for Determining <i>n</i> -Hexane in Environmental Samples	186
7-1	Regulations and Guidelines Applicable to <i>n</i> -Hexane	196

1. PUBLIC HEALTH STATEMENT

This public health statement tells you about *n*-hexane and the effects of exposure.

The Environmental Protection Agency (EPA) identifies the most serious hazardous waste sites in the nation. These sites make up the National Priorities List (NPL) and are the sites targeted for long-term federal cleanup activities. *n*-Hexane has been found in at least 60 of the 1,467 current or former NPL sites. However, the total number of NPL sites evaluated for this substance is not known. As more sites are evaluated, the sites at which *n*-hexane is found may increase. This information is important because exposure to this substance may harm you and because these sites may be sources of exposure.

When a substance is released from a large area, such as an industrial plant, or from a container, such as a drum or bottle, it enters the environment. This release does not always lead to exposure. You are exposed to a substance only when you come in contact with it. You may be exposed by breathing, eating, or drinking the substance or by skin contact.

If you are exposed to *n*-hexane, many factors determine whether you'll be harmed. These factors include the dose (how much), the duration (how long), and how you come in contact with it. You must also consider the other chemicals you're exposed to and your age, sex, diet, family traits, lifestyle, and state of health.

1.1 WHAT IS *n*-HEXANE?

n-Hexane is a chemical made from crude oil. Pure *n*-hexane is a colorless liquid with a slightly disagreeable odor. It evaporates very easily into the air and dissolves only slightly in water.

n-Hexane is highly flammable, and its vapors can be explosive.

Pure *n*-hexane is used in laboratories. Most of the *n*-hexane used in industry is mixed with similar chemicals in products known as solvents. Common names for some of these solvents are "commercial hexane," "mixed hexanes," "petroleum ether," and "petroleum naphtha." An older

1. PUBLIC HEALTH STATEMENT

name for these types of solvents is “petroleum benzine.” Several hundred million pounds of *n*-hexane are produced in the United States each year in the form of these solvents. The major use for solvents containing *n*-hexane is to extract vegetable oils from crops such as soybeans. They are also used as cleaning agents in the printing, textile, furniture, and shoemaking industries. Certain kinds of special glues used in the roofing and the shoe and leather industries also contain *n*-hexane. Several consumer products contain *n*-hexane. For example, gasoline contains about 1-3% *n*-hexane. *n*-Hexane is also present in rubber cement. You will find further information about the properties and uses of *n*-hexane in Chapters 3 and 4 of this profile.

1.2 WHAT HAPPENS TO *n*-HEXANE WHEN IT ENTERS THE ENVIRONMENT?

n-Hexane enters the air, water, and soil during its manufacture and use. Wastes containing *n*-hexane are sometimes disposed of in landfills. *n*-Hexane can enter the environment from these landfills. *n*-Hexane also enters the environment from accidental spills during transport and leaks from storage containers.

n-Hexane evaporates very easily into the air. Once in the air, *n*-hexane can react with oxygen and be broken down. *n*-Hexane released into the air is broken down in a few days.

If *n*-hexane is spilled into a lake or river, a very small portion will dissolve in the water, but most will float on the surface. The *n*-hexane will then evaporate into the air. The *n*-hexane dissolved in the water can be broken down by certain types of bacteria, although it is not known how long this takes.

If *n*-hexane is spilled on the ground, much of it will evaporate into the air before it penetrates the soil. Any *n*-hexane that penetrated the soil would probably be broken down by bacteria. If *n*-hexane leaks from an underground storage tank, it will float on the groundwater, rather than mixing with it since *n*-hexane is lighter than water.

1. PUBLIC HEALTH STATEMENT

n-Hexane is not stored or concentrated by plants, fish, or animals. You will find more information about what happens to *n*-hexane in the environment in Chapter 5 of this profile.

1.3 HOW MIGHT I BE EXPOSED TO *n*-HEXANE?

Since gasoline contains *n*-hexane, almost everyone is exposed to small amounts of *n*-hexane in the air. The *n*-hexane in gasoline is released into the air at service stations and in automobile exhaust. Some people may also be exposed by spilling gasoline on their skin. The concentration of *n*-hexane in the air in Chicago was recently measured and contained 2 parts *n*-hexane per 1 billion parts air (2 ppb). *n*-Hexane has generally not been found in most foods or drinking water, so you are not likely to be exposed by eating or drinking. Because cooking oils are processed with solvents containing *n*-hexane, very small amounts may be present in these products. However, the amounts in cooking oil are too low to have any effect on people.

People living near hazardous waste sites containing *n*-hexane or near its manufacturing, processing, or storage facilities could potentially be exposed. Because of the chemical properties of *n*-hexane, the most likely way a person would be exposed is by breathing in air contaminated with *n*-hexane. A less likely way for a person to be exposed is by drinking contaminated private well water.

You may be exposed to *n*-hexane if you use products containing it at work. This exposure will mainly be by breathing in air containing *n*-hexane, but you can also be exposed through your skin by contact with substances containing *n*-hexane. Some occupational groups that may be exposed to *n*-hexane include refinery workers, shoe and footwear assembly workers, laboratory technicians, workers operating or repairing typesetting and printing machinery, construction workers, carpet layers, carpenters, auto mechanics and gas station employees, workers in plants manufacturing tires or inner tubes, and workers in air transport and air freight operations. Exposure can also occur in the home if products containing *n*-hexane are used without proper ventilation.

1. PUBLIC HEALTH STATEMENT

1.4 HOW CAN *n*-HEXANE ENTER AND LEAVE MY BODY?

n-Hexane can enter your body through your lungs if it is in the air you breathe. It can also enter your body through your stomach and intestines if it is in your drinking water or food, or through your skin if you come into contact with it. How much *n*-hexane enters your body depends on how long you are exposed and the amount to which you are exposed.

Once you inhale *n*-hexane, it goes into your bloodstream and is carried to all the organs in your body. Enzymes in your liver break down *n*-hexane. If you are exposed to high concentrations of *n*-hexane over a long period, one of these breakdown products may cause damage to your nervous system. Most of these breakdown products leave your body in the urine within a day or two. *n*-Hexane and its breakdown products are not stored in your body.

1.5 HOW CAN *n*-HEXANE AFFECT MY HEALTH?

Almost all the people known to have had their health affected by exposure to *n*-hexane used it at work. In the 1960s and early 1970s several outbreaks of nerve disorders occurred among shoe workers in Japan and Italy. Doctors determined the disease was caused by the workers breathing air containing high concentrations of *n*-hexane. The *n*-hexane came from glues and solvents the workers used in assembling the shoes. In one group of workers in Japan, it was estimated that the workers who became ill had been breathing air containing 500-2,500 parts *n*-hexane per million parts air (500-2500 ppm) for 8-14 hours a day for 6 months to several years. The first symptom that the affected workers had was a feeling of numbness in their feet and hands. This was followed by muscle weakness in the feet and lower legs. If exposure continued, the symptoms grew worse. In some workers, paralysis of the arms and legs developed. When the affected workers were examined by doctors, the nerves controlling the muscles in their arms and legs were found to be damaged. The medical term for this condition is "peripheral neuropathy" (peripheral means outside the brain and spinal cord; neuropathy means nerve damage). Fortunately, once the workers were removed from exposure to *n*-hexane they recovered within 6 months to a year, although some of the more severely affected did not fully recover for 1-2 years.

1. PUBLIC HEALTH STATEMENT

Poor ventilation of the work area was a major factor in all of these cases. Workers who became ill usually worked in their homes or in very small workshops. Since the 1970s workplace ventilation has been improved and levels of *n*-hexane in the air have been lower. There have been very few cases of nerve damage from *n*-hexane since 1980. A few people have also suffered nerve damage from “sniffing” products containing *n*-hexane. Like cases in the workplace, the number of cases due to sniffing has fallen since the 1970s.

It is not known if oral or skin exposure to *n*-hexane can cause these effects in people. There have been very few documented exposures to *n*-hexane by these routes in people.

To protect the public from the harmful effects of toxic chemicals and to find ways to treat people who have been harmed, scientists use many tests.

One way to see if a chemical will hurt people is to learn how the chemical is absorbed, used, and released by the body; for some chemicals, animal testing may be necessary. Animal testing may also be used to identify health effects such as cancer or birth defects. Without laboratory animals, scientists would lose a basic method to get information needed to make wise decisions to protect public health. Scientists have the responsibility to treat research animals with care and compassion. Laws today protect the welfare of research animals, and scientists must comply with strict animal care guidelines.

When rats are exposed to *n*-hexane in the air, they show signs of damage to their nervous systems very similar to those seen in people who became ill after workplace exposure. As in people, these effects in rats depend on the concentrations of *n*-hexane in air and how long exposure lasts. Studies in rats showed that a breakdown product of *n*-hexane (called 2,5-hexanedione) causes the nerve damage, not *n*-hexane itself. Testing for 2,5-hexanedione in the urine can be used to determine if a person has been exposed to potentially harmful amounts of *n*-hexane. Studies in rats also showed that *n*-hexane can cause nerve damage when given orally in very large doses.

1. PUBLIC HEALTH STATEMENT

At very high levels of *n*-hexane in air (1,000-10,000 ppm), signs of damage to sperm-forming cells in male rats occurred. Damage to the lungs occurred in rabbits and mice. People have rarely been exposed to these high levels of *n*-hexane, so it is not known if these effects would occur in people.

It is not known if exposure to *n*-hexane can affect fertility in people. Experiments done with animals that were fed or breathed in *n*-hexane did not show any effect on fertility.

There is no evidence that exposure to *n*-hexane increases the risk of cancer in people. No reliable information is available on whether *n*-hexane causes cancer in animals. In an animal experiment with commercial hexane (which contains *n*-hexane), an increase in liver cancer was found in female mice after exposure for 2 years. No increase was found in male mice or in rats of either sex. Commercial hexane is a mixture, and we do not know what parts of the mixture caused the cancer in the female mice. *n*-Hexane has not been characterized for carcinogenicity by the Department of Health and Human Services (DHHS), the International Agency for Research on Cancer (IARC), or the Environmental Protection Agency (EPA).

1.6 HOW CAN *n*-HEXANE AFFECT CHILDREN?

This section discusses potential health effects from exposures during the period from conception to maturity at 18 years of age in humans. Potential effects on children resulting from exposures of the parents are also considered.

Harmful effects from exposure to *n*-hexane have mainly occurred in adults. This is because most known cases have occurred in workers. However, it is probable that if children were exposed to *n*-hexane at levels that cause harmful effects in adults, similar effects would occur. We do not know whether children differ from adults in their susceptibility to health effects from *n*-hexane exposure. Only a few animal studies have compared the effects of *n*-hexane between adults and young animals. In these studies, the young animals were somewhat less likely to have harmful

1. PUBLIC HEALTH STATEMENT

effects on their nervous system from breathing *n*-hexane than the adults, but more likely to die from a large oral dose.

Experiments in rats and mice have shown little effect of *n*-hexane exposure on the development of the fetus. It is probable that *n*-hexane and its breakdown products can cross the placenta and also be excreted in breast milk, but no accurate measurements have been made in people. *n*-Hexane and its breakdown products have been detected in the fetus when pregnant rats were exposed to *n*-hexane.

1.7 HOW CAN FAMILIES REDUCE THE RISK OF EXPOSURE TO *n*-HEXANE?

If your doctor finds that you have been exposed to significant amounts of *n*-hexane, ask whether your children might also be exposed. Your doctor might need to ask your state public health department to investigate.

Certain products used in the home may contain *n*-hexane, for example, some quick-drying glues and cements used in hobbies. These products should be kept out of the reach of children and only used with proper ventilation. Always store household chemicals in their original, labeled containers. Never store household chemicals in containers children would find attractive to eat or drink from, such as old soda bottles. Keep your Poison Control Center's number by the phone.

Sometimes older children sniff household chemicals in an attempt to get "high." Your children may be exposed to *n*-hexane by inhaling products containing it. Talk with your children about the dangers of sniffing chemicals. Sniffing products containing *n*-hexane has caused paralysis of the arms and legs in teenagers in the United States and Europe.

1. PUBLIC HEALTH STATEMENT

1.8 IS THERE A MEDICAL TEST TO DETERMINE WHETHER I HAVE BEEN EXPOSED TO *n*-HEXANE?

If you have been exposed to harmful amounts of *n*-hexane, the amount of one of its breakdown products (2,5-hexanedione) will probably be increased in your urine. Your doctor will have to send a sample to a specialized laboratory. This test can only detect *n*-hexane exposure occurring within 2-3 days before the test, since 2,5-hexanedione leaves the body within a few days after exposure.

1.9 WHAT RECOMMENDATIONS HAS THE FEDERAL GOVERNMENT MADE TO PROTECT HUMAN HEALTH?

The federal government develops regulations and recommendations to protect public health. Regulations can be enforced by law. Federal agencies that develop regulations for toxic substances include the Environmental Protection Agency (EPA), the Occupational Safety and Health Administration (OSHA), and the Food and Drug Administration (FDA). Recommendations provide valuable guidelines to protect public health but cannot be enforced by law. Federal organizations that develop recommendations for toxic substances include the Agency for Toxic Substances and Disease Registry (ATSDR) and the National Institute for Occupational Safety and Health (NIOSH).

Regulations and recommendations can be expressed in not-to-exceed levels in air, water, soil, or food that are usually based on levels that affect animals; then they are adjusted to help protect people. Sometimes these not-to-exceed levels differ among federal organizations because of different exposure times (an 8-hour workday or a 24-hour day), the use of different animal studies, or other factors.

Recommendations and regulations are also periodically updated as more information becomes available. For the most current information, check with the federal agency or organization that provides it. Some regulations and recommendations for *n*-hexane include the following:

1. PUBLIC HEALTH STATEMENT

OSHA has set a Permissible Exposure Limit (PEL) of 500 ppm for *n*-hexane in workplace air. A court decision struck down a proposed PEL of 50 ppm. Damage to nerves has been found in people at 500 ppm. The American Conference of Governmental Industrial Hygienists (ACGIH) recommends a Threshold Limit Value (TLV) of 50 ppm.

1.10 WHERE CAN I GET MORE INFORMATION?

If you have any more questions or concerns, please contact your community or state health or environmental quality department or

Agency for Toxic Substances and Disease Registry
Division of Toxicology
1600 Clifton Road NE, Mailstop E-29
Atlanta, GA 30333

* Information line and technical assistance

Phone: 1-888-42-ATSDR (1-888-422-8737)
Fax: (404) 639-6315 or -6324

ATSDR can also tell you the location of occupational and environmental health clinics. These clinics specialize in recognizing, evaluating, and treating illnesses resulting from exposure to hazardous substances.

* To order toxicological profiles, contact

National Technical Information Service
5285 Port Royal Road
Springfield, VA 22161
Phone: (800) 553-6847 or (703) 605-6000

2. HEALTH EFFECTS

2.1 INTRODUCTION

The primary purpose of this chapter is to provide public health officials, physicians, toxicologists, and other interested individuals and groups with an overall perspective of the toxicology of *n*-hexane. It contains descriptions and evaluations of toxicological studies and epidemiological investigations and provides conclusions, where possible, on the relevance of toxicity and toxicokinetic data to public health.

A glossary and list of acronyms, abbreviations, and symbols can be found at the end of this profile.

2.2 DISCUSSION OF HEALTH EFFECTS BY ROUTE OF EXPOSURE

To help public health professionals and others address the needs of persons living or working near hazardous waste sites, the information in this section is organized first by route of exposure-inhalation, oral, and dermal; and then by health effect-death, systemic, immunological, neurological, reproductive, developmental, genotoxic, and carcinogenic effects. These data are discussed in terms of three exposure periods-acute (14 days or less), intermediate (15-364 days), and chronic (365 days or more).

Levels of significant exposure for each route and duration are presented in tables and illustrated in figures. The points in the figures showing no-observed-adverse-effect levels (NOAELs) or lowest-observed-adverse-effect levels (LOAELs) reflect the actual doses (levels of exposure) used in the studies. LOAELs have been classified into “less serious” or “serious” effects. “Serious” effects are those that evoke failure in a biological system and can lead to morbidity or mortality (e.g., acute respiratory distress or death). “Less serious” effects are those that are not expected to cause significant dysfunction or death, or those whose significance to the organism is not entirely clear. ATSDR acknowledges that a considerable amount of judgment may be required in establishing whether an end point should be classified as a NOAEL, “less serious” LOAEL, or “serious” LOAEL, and that in some cases, there will be insufficient data to decide whether the effect is indicative of significant dysfunction. However, the Agency has established guidelines and policies that are used to classify these end points. ATSDR believes that there is sufficient merit in this approach to warrant an attempt at distinguishing between “less serious” and “serious” effects. The distinction between “less serious” effects and “serious” effects is considered to be important because it helps the users of the profiles to identify levels of exposure at which major health effects start to appear.

2. HEALTH EFFECTS

LOAELs or NOAELs should also help in determining whether or not the effects vary with dose and/or duration, and place into perspective the possible significance of these effects to human health.

The significance of the exposure levels shown in the Levels of Significant Exposure (LSE) tables and figures may differ depending on the user's perspective. Public health officials and others concerned with appropriate actions to take at hazardous waste sites may want information on levels of exposure associated with more subtle effects in humans or animals (LOAELs) or exposure levels below which no adverse effects (NOAELs) have been observed. Estimates of levels posing minimal risk to humans (Minimal Risk Levels or MRLs) may be of interest to health professionals and citizens alike.

Levels of exposure associated with carcinogenic effects (Cancer Effect Levels, CELs) of *n*-hexane are indicated in Table 2-1 and Figure 2-1.

Estimates of exposure levels posing minimal risk to humans (Minimal Risk Levels or MRLs) have been made for *n*-hexane. An MRL is defined as an estimate of daily human exposure to a substance that is likely to be without an appreciable risk of adverse effects (noncarcinogenic) over a specified duration of exposure. MRLs are derived when reliable and sufficient data exist to identify the target organ(s) of effect or the most sensitive health effect(s) for a specific duration within a given route of exposure. MRLs are based on noncancerous health effects only and do not consider carcinogenic effects. MRLs can be derived for acute, intermediate, and chronic duration exposures for inhalation and oral routes. Appropriate methodology does not exist to develop MRLs for dermal exposure.

Although methods have been established to derive these levels (Barnes and Dourson 1988; EPA 1990), uncertainties are associated with these techniques. Furthermore, ATSDR acknowledges additional uncertainties inherent in the application of the procedures to derive less than lifetime MRLs. As an example, acute inhalation MRLs may not be protective for health effects that are delayed in development or are acquired following repeated acute insults, such as hypersensitivity reactions, asthma, or chronic bronchitis. As these kinds of health effects data become available and methods to assess levels of significant human exposure improve, these MRLs will be revised.

A User's Guide has been provided at the end of this profile (see Appendix B). This guide should aid in the interpretation of the tables and figures for Levels of Significant Exposure and the MRLs.

2. HEALTH EFFECTS

1.2.1 Inhalation Exposure

2.2.1.1 Death

No studies were located describing death in humans after inhalation exposure to *n*-hexane. This includes cases of occupational exposure where severe neurological effects occurred (see Section 2.2.1.4).

No studies were located describing death in test animals after acute-duration inhalation exposure to pure *n*-hexane. An LC₅₀ (lethal concentration, 50% kill) of 73,680 ppm was reported in male Long-Evans rats exposed for 4 hours to a C6 aliphatic hydrocarbon fraction containing only *n*-hexane and its isomers (Hine and Zuidema 1970). All deaths occurred during the 4-hour exposures with the exception of 1 rat exposed at 81,800 ppm, which had convulsions during and after exposure and died during the sixth day. Rats that survived were uncoordinated, prostrate, or comatose during exposure but recovered within a few hours after removal from the chamber. Concentrations resulting in death in test animals are far above the reported explosive limit for *n*-hexane vapor (approximately 11,000 ppm) (see Chapter 3).

In other acute-duration inhalation studies on *n*-hexane in experimental animals, no deaths were reported in pregnant Fischer 344 rats exposed to 1,000 ppm *n*-hexane for 6 hours a day for 5 or 9 days (Bus et al. 1979) or male Sprague-Dawley rats exposed to 5,000 ppm for 24 hours and observed for a further 14 days (De Martino et al. 1987). Exposures at 5,000 ppm in pregnant rats for 20 hours a day for 14 days, or in male mice for 20 hours a day for 5 consecutive days, also resulted in no deaths (Mast et al. 1987).

Deaths have been reported after intermediate-duration inhalation exposures to relatively high concentrations of *n*-hexane. These deaths appear to be related to a failure to gain weight, compounded by development of severe neuropathy which makes eating and drinking difficult. In male Wistar rats exposed to 3,040 ppm *n*-hexane 12 hours a day for 16 weeks, 2 of 7 rats died shortly before the end of the study (after 109 and 111 days of exposure). Both animals showed unsteady gait and foot-drop before death (Takeuchi et al. 1980). No deaths occurred in rats exposed at similar concentrations to the structurally related chemicals *n*-pentane or *n*-heptane for the same duration. Deaths were also reported in young male Fischer 344 rats (80 days old) after an 11-week exposure to 1,000 ppm *n*-hexane for 24 hours a day, 6 days a week (Howd et al. 1983). Two rats died during the 11th week of exposure; 2 died during week 12 (first week of recovery); and 1 died during week 14 (third week of recovery). The deaths appeared to be related to weight loss (treated rats weighed only 46% as much as age-matched controls). Advanced neuropathy and

2. HEALTH EFFECTS

subsequent muscle weakness made eating and drinking difficult. No deaths occurred in male weanling rats (20 days old at initiation) exposed similarly (Howd et al. 1983). Four of 8 male Fischer 344 rats died within 6 weeks after an 11-week exposure to 1,500 ppm *n*-hexane for 24 hours a day, 5 days a week (Rebert and Sorenson 1983). Signs preceding death were not stated. Deaths also occurred in 2 of 12 male New Zealand rabbits exposed to 3,000 ppm *n*-hexane for 8 hours a day, 5 days a week for 24 weeks (Lungarella et al. 1984). The time to death was not reported. Before death, the rabbits had signs of breathing difficulties (gasping, lung rales, mouth breathing). In a study where male Sprague-Dawley rats were exposed to 5,000 ppm *n*-hexane for 16 hours a day for up to 6 weeks, the authors stated that after 4 weeks, some animals had to be removed from treatment to prevent death after severe paralysis developed (De Martino et al. 1987).

Other intermediate-duration inhalation exposures to *n*-hexane in experimental animals report no deaths as the result of treatment (Abou-Donia et al. 1985, 1991; Altenkirch et al. 1982; Bio/Dynamics 1978; Cavender et al. 1984; Dunnick et al. 1989; Huang et al. 1989; IRDC 1981; NTP 1991). Generally, the daily exposure in these studies was 6-8 hours. The highest *n*-hexane concentration used in these studies was 10,000 ppm 6 hours a day, 5 days a week for 13 weeks in B6C3F₁ mice (Dunnick et al. 1989; NTP 1991) and Fischer 344 rats (Cavender et al. 1984). The longest duration exposure was 8 hours a day for 40 weeks at 700 ppm *n*-hexane in male Wistar rats (Altenkirch et al. 1982).

Reliable LOAEL values for death in rats and rabbits for intermediate-duration exposure are recorded in Table 2-1 and plotted in Figure 2-1.

2.2.1.2 Systemic Effects

The highest NOAEL values and all reliable LOAEL values for systemic effects in each species and duration category are recorded in Table 2-1 and plotted in Figure 2-1. No chronic-duration inhalation studies for exposure to *n*-hexane in experimental animals were located.

Respiratory Effects. Hexane was one of 16 industrial solvents (hydrocarbons, alcohols, ketones, esters, and ethyl ether) tested for irritation potential on an average of 10 volunteers of mixed sexes for 3-5 minutes in an inhalation chamber (Nelson et al. 1943). The purity and the isomer composition of the hexane was not specified. Hexane was the only one of the 16 solvents which caused no irritation to the eyes, nose, or throat at the highest concentration tested (500 ppm). No odor was reported.

Table 2-1. Levels of Significant Exposure to n-Hexane - Inhalation

Key to figure ^a	Species (strain)	Exposure/ duration/ frequency	System	NOAEL (ppm)	LOAEL		Reference
					Less serious (ppm)	Serious (ppm)	
ACUTE EXPOSURE							
Systemic							
1	Rat (Hybrid)	10 d 6 hr/d Gd 6-15	Bd Wt	409 F			Litton Bionetics 1979
2	Rat (Sprague- Dawley)	14 d 20 hr/d Gd 6-19	Bd Wt	1000 F		5000 F (31% reduced weight gain in dams)	Mast et al. 1987
3	Rat (Fischer- 344)	2 wk 5 d/wk 24 hr/d	Bd Wt Metab	 1500 M	1500 M (approx. 11% decreased body weight at 2 weeks)		Rebert and Sorenson 1983
4	Mouse (Swiss)	12 d 20 hr/d	Bd Wt	5,000			Mast et al. 1988
5	Mouse (B6C3F1)	5 d 20 hr/d	Bd Wt	5000 M			Mast et al. 1989a
6	Mouse (Swiss CD-1)	5 d 20 hr/d	Bd Wt	5000 M			Mast et al. 1989b
7	Rabbit (New Zealand)	14 d 5 d/wk 8 hr/d	Resp		3000M (nasal discharge, gasping, lung rales, mouth breathing)		Lungarella et al. 1984
Neurological							
8	Rat (Sprague- Dawley)	1 wk 6 d/wk 16 hr/d			5000M (11% decrease in MCV)		De Martino et al. 1987

Table 2-1. Levels of Significant Exposure to n-Hexane - Inhalation (continued)

Key to figure ^a	Species (strain)	Exposure/duration/frequency	System	NOAEL (ppm)	LOAEL		Reference
					Less serious (ppm)	Serious (ppm)	
Reproductive							
9	Rat (Sprague-Dawley)	24 hr				5000 M (spermatid and spermatocyte degeneration, exfoliation)	De Martino et al. 1987
10	Rat (Sprague-Dawley)	2-8 d 16 hr/d				5000 M (spermatid and spermatocyte degeneration, exfoliation)	De Martino et al. 1987
11	Mouse (B6C3F1)	5 d 20 hr/d		5000 M			Mast et al. 1989a
12	Mouse (B6C3F1)	5 d 20 hr/d		5000 M			Mast et al. 1989b
Developmental							
13	Rat (Fischer- 344)	5 d 6 hr/d Gd 8-12		1000			Bus et al. 1979
14	Rat (Fischer- 344)	5 d 6 hr/d Gd 12-16		1000			Bus et al. 1979
15	Rat (Fischer- 344)	9 d 6 hr/d Gd 8-16			1000	(temporary decrease in pup growth rate)	Bus et al. 1979
16	Rat (Hybrid)	10 d 6 hr/d Gd 6-15		409			Litton Bionetics 1979
17	Rat (Sprague-Dawley)	14 d 20 hr/d Gd 6-19		200	1000	(7% decrease in fetal weight in males only)	Mast et al. 1987

Table 2-1. Levels of Significant Exposure to n-Hexane - Inhalation (continued)

Key to figure ^a	Species (strain)	Exposure/ duration/ frequency	System	NOAEL (ppm)	LOAEL		Reference	
					Less serious (ppm)	Serious (ppm)		
18	Mouse (Swiss)	12 d GD 6-17 20 hr/d				5000	(decreased live fetuses per litter, female fetus weight, gravid uterine weight)	Mast et al. 1988
INTERMEDIATE EXPOSURE								
Death								
19	Rat (Fischer- 344)	11 wk 6 d/wk 24 hr/d				1000	M (5/10 died in young adult group)	Howd et al. 1983
20	Rat (Fischer- 344)	11 wk 5 d/wk 24 hr/d				1500	M (4/8 died)	Rebert and Sorenson 1983
21	Rat (Wistar)	16 wk 7 d/wk 12 hr/d				3040	M (2/7 died)	Takeuchi et al. 1980
22	Rabbit (New Zealand)	24 wk 5 d/wk 8 hr/d				3000	M (2/12 died)	Lungarella et al. 1984
Systemic								
23	Rat (Sprague-Dawley)	8-26 wk 5 d/wk 6 hr/d	Hemato	129				Bio/Dynamics 1978
			Bd Wt	129				
			Metab	26 M 129 F	129M (higher fasting glucose)			

Table 2-1. Levels of Significant Exposure to n-Hexane - Inhalation (continued)

Key to figure	Species (strain)	Exposure/ duration/ frequency	System	NOAEL (ppm)	LOAEL		Reference
					Less serious (ppm)	Serious (ppm)	
24	Rat (Sprague-Dawley)	8-26 wk 7 d/wk 21 hr/d	Hemato	126			Bio/Dynamics 1978
			Hepatic	27 F 126 M	126 F (decreased blood urea nitrogen)		
			Bd Wt	126			
25	Rat (Fischer-344)	13 wk 5 d/wk 6 hr/d	Resp	10000			Cavender et al. 1984
			Cardio	10000			
			Gastro	10000			
			Hemato	10000			
			Renal	6500 M 10000 F	10000M (decreased urine pH)		
			Endocr	10000			
			Dermal	10000			
			Ocular	10000			
			Bd Wt	6500 M 10000 F	10000M (11% decrease)		
26	Rat (Fischer-344)	11 wk 6 d/wk 24 hr/d	Bd Wt			1000 M (54 & 33% decreased body weight at end of exposure in young adults and weanlings, respectively)	Howd et al. 1983
27	Rat (Wistar)	16 wk 7 d/wk 12 hr/d	Bd Wt	500 M	1200M (13% decrease)		Huang et al. 1989

Table 2-1. Levels of Significant Exposure to n-Hexane - Inhalation (continued)

Key to figure ^a	Species (strain)	Exposure/ duration/ frequency	System	NOAEL (ppm)	LOAEL		Reference
					Less serious (ppm)	Serious (ppm)	
28	Rat (Sprague- Dawley)	6 mo 7 d/wk 22 hr/d	Resp	500 M			IRDC 1981
			Cardio	500 M			
			Gastro	500 M			
			Musc/skel		500M (mild atrophy in gastrocnemius muscle in 3/10)		
			Hepatic	500 M			
			Renal		500M (increases in kidney weight and incidence and severity of chronic nephritis)		
			Endocr	500 M			
29	Rat (Sprague- Dawley)	28-61 d 7 d/wk 18-21 hr/d	Musc/skel			500 M (30% decrease)	Nylen et al. 1989
						986 M (severe hindlimb atrophy)	
30	Rat (Fischer- 344)	11 wk 5 d/wk 24 hr/d	Bd Wt		500 M (10% decrease at 8 weeks)	1000 M (20% decrease at 8 weeks)	Rebert and Sorenson 1983
			Metab	1500 M			
31	Rat (Wistar)	16 wk 7 d/wk 12 hr/d	Musc/skel			3040 M (atrophy, denervation, irregular fibers, disordered myofilaments)	Takeuchi et al. 1980
			Bd Wt			3040 M (33% decrease)	

Table 2-1. Levels of Significant Exposure to n-Hexane - Inhalation (continued)

Key to figure ^a	Species (strain)	Exposure/ duration/ frequency	System	NOAEL (ppm)	LOAEL		Reference		
					Less serious (ppm)	Serious (ppm)			
32	Mouse (B6C3F1)	13 wk 5 d/wk 22 hr/d	Resp		1000	(mild multifocal regeneration, metaplasia in olfactory epithelium)		Dunnick et al. 1989; NTP 1991	
			Cardio	1000					
			Gastro	1000					
			Hemato	1000					
			Hepatic	1000					
			Renal	1000					
			Endocr	1000					
			Dermal	1000					
			Bd Wt		1000M (10% decrease)				
			Metab	1000					
33	Mouse (B6C3F1)	13 wk 5 d/wk 6 hr/d	Resp	500	1000	(multifocal regeneration and metaplasia in olfactory epithelium)	10000	(multifocal erosion, regeneration, inflammation, metaplasia in olfactory and respiratory epithelium, sneezing)	Dunnick et al. 1989; NTP 1991
			Cardio	10000					
			Gastro	10000					
			Hemato	4000	10000M (increase in segmented neutrophils)				
			Hepatic	10000					
			Renal	10000					
			Endocr	10000					
			Dermal	10000					
			Bd Wt	4000 M	10000M (17% decrease)				
			Metab	10000					

Table 2-1. Levels of Significant Exposure to n-Hexane - Inhalation (continued)

Key to figure ^a	Species (strain)	Exposure/ duration/ frequency	System	NOAEL (ppm)	LOAEL		Reference
					Less serious (ppm)	Serious (ppm)	
34	Rabbit (New Zealand)	24 wk 5 d/wk 8 hr/d	Resp			3000 M (centriobular emphysema, fibrosis, goblet cell metaplasia, epithelial desquamation, respiratory tract irritation)	Lungarella et al. 1984
			Hemato Bd Wt	3000 M 3000 M			
35	Chicken (Leghorn)	90 d 24 hr/d	Bd Wt		1000 F (12% decrease)		Abou-Donia et al. 1985
36	Chicken (Leghorn)	30 d 24 hr/d	Bd Wt			1008 F (21% decrease)	Abou-Donia et al. 1991
Immunological/Lymphoreticular							
37	Rat (Sprague- Dawley)	6 mo 7 d/wk 22 hr/d		500 M			IRDC 1981
38	Mouse (B6C3F1)	13 wk 5 d/wk 6h/d		10000			Dunnick et al. 1989; NTP 1991
39	Mouse (B6C3F1)	13 wk 5 d/wk 22 hr/d		1000			Dunnick et al. 1989; NTP 1991
Neurological							
40	Rat (Wistar)	9 wk 7 d/wk 22 hr/d				500 M (narcosis, paralysis, axonal degeneration in peripheral nerve, axonal swelling in cervical spinal cord)	Altenkirch et al. 1982

Table 2-1. Levels of Significant Exposure to n-Hexane - Inhalation (continued)

Key to figure ^a	Species (strain)	Exposure/ duration/ frequency	System	NOAEL (ppm)	LOAEL		Reference
					Less serious (ppm)	Serious (ppm)	
41	Rat (Wistar)	40 wk 7 d/wk 8 hr/d		700 M			Altenkirch et al. 1982
42	Rat (Fischer- 344)	13 wk 5 d/wk 6 hr/d		3000 M 10000 F	6500 M (axonal swelling in sciatic nerve in 1/5)		Cavender et al. 1984
43	Rat (Sprague- Dawley)	1-6 wk 6 d/wk 16 hr/d				5000 M (20-35% decrease in MCV, peripheral neuropathy, paralysis)	De Martino et al. 1987
44	Rat (Sprague- Dawley)	7 wk 5 d/wk 9 hr/d		5000 M			Frontali et al. 1981
45	Rat (Sprague- Dawley)	14 wk 5 d/wk 9 hr/d		1500 M		5000 M (tibial nerve axonal degeneration)	Frontali et al. 1981
46	Rat (Sprague- Dawley)	30 wk 5-6 d/wk 9-10 hr/d		500 M		2500 M (tibial nerve axonal degeneration)	Frontali et al. 1981
47	Rat (Fischer- 344)	11 wk 6 d/wk 24 hr/d				1000 M (hindlimb paralysis)	Howd et al. 1983
48	Rat (Wistar)	16 wk 7 d/wk 12 hr/d		500 M		1200 M (decreased grip strength and MCV, axonal swelling and demyelination)	Huang et al. 1989
49	Rat (Sprague- Dawley)	6 mo 7 d/wk 22 hr/d				500 M (gait disturbance, peripheral nerve atrophy)	IRDC 1981

Table 2-1. Levels of Significant Exposure to n-Hexane - Inhalation (continued)

Key to figure ^a	Species (strain)	Exposure/duration/frequency	System	NOAEL (ppm)	LOAEL		Reference
					Less serious (ppm)	Serious (ppm)	
50	Rat (Fischer-344)	11 wk 5 d/wk 24 hr/d				500 M (decreased fore- & hindlimb grip strength; increased latency of evoked potentials in CNS)	Rebert and Sorenson 1983
51	Rat (Sprague-Dawley)	42-162 d 7 d/wk 24 hr/d				400-600 (central and peripheral neuropathy, foot-drop, waddling gait, limb weakness, swollen axons, axonal degeneration)	Schaumburg and Spencer 1976
52	Rat (Wistar)	16 wks 7 d/wk 12 hr/d				3040 M (gait disturbances, axonal swelling, neurofilament accumulation, denervated neuromuscular junctions)	Takeuchi et al. 1980
53	Mouse (B6C3F1)	13 wk 5 d/wk 6 hr/d		4000	10000	(decreased locomotor activity, paranodal swellings in tibial nerve)	Dunnick et al. 1989; NTP 1991
54	Mouse (B6C3F1)	13 wk 5 d/wk 22 hr/d			1000	(paranodal swellings in tibial nerve)	Dunnick et al. 1989; NTP 1991
55	Rabbit (New Zealand)	24 wk 5 d/wk 8 hr/d		3000 M			Lungarella et al. 1984
56	Chicken (Leghorn)	90 d 24 hr/d				1000 F (axonal degeneration in ventral columns of thoracic spinal cord in 1/5)	Abou-Donia et al. 1985
57	Chicken (Leghorn)	30 d 24 hr/d		1008 F			Abou-Donia et al. 1991

Table 2-1. Levels of Significant Exposure to n-Hexane - Inhalation (continued)

Key to figure ^a	Species (strain)	Exposure/ duration/ frequency	System	NOAEL (ppm)	LOAEL		Reference
					Less serious (ppm)	Serious (ppm)	
Reproductive							
58	Rat (Fischer- 344)	13 wk 5 d/wk 6 hr/d		10000			Cavender et al. 1984
59	Rat (Sprague- Dawley)	1-6 wk 6 d/wk 16 hr/d				5000 M (testicular aplasia)	De Martino et al. 1987
60	Rat (Fischer- 344)	11 wk 6 d/wk 24 hr/d			1000 M (decreased testes weight)		Howd et al. 1983
61	Rat (Sprague- Dawley)	6 mo 7 d/wk 22 hr/d		500 M			IRDC 1981
62	Rat (Sprague- Dawley)	28-61 d 7 d/wk 18-21 hr/d				1000 M (testicular atrophy)	Nylen et al. 1989
63	Mouse (B6C3F1)	13 wk 5 d/wk 6 hr/d		10000			Dunnick et al. 1989; NTP 1991
64	Mouse (B6C3F1)	13 wk 5 d/wk 22 hr/d		1000			Dunnick et al. 1989; NTP 1991
65	Mouse (CD-1)	8 wks 5 d/wk 6 hr/d		396 M			Litton Bionetics 1980

Table 2-1. Levels of Significant Exposure to n-Hexane - Inhalation (continued)

Key to figure ^a	Species (strain)	Exposure/ duration/ frequency	System	NOAEL (ppm)	LOAEL		Reference
					Less serious (ppm)	Serious (ppm)	
Cancer							
66	Rabbit (New Zealand)	24 wk 5 d/wk 8 hr/d				3000 M (CEL: papillary tumors in bronchiolar epithelium)	Lungarella et al. 1984
CHRONIC EXPOSURE							
Neurological							
67	Human	9.1 yr			69 (decreased MCV and motor action potential amplitude)		Mutti et al. 1982a
68	Human	4.5 yr			195 F (decreased MCV)		Mutti et al. 1982b
69	Human	6.2 yr			58 ^b M (decreased MCV)		Sanagi et al. 1980
70	Human	5 yr				190 (peripheral neuropathy, gait disturbance, decreased MCV)	Wang et al. 1986
Cancer							
71	Mouse (B6C3F1)	2 yr 5 d/wk 6 hr/d				9018 ^c F (CEL: increased incidence of hepatocellular adenomas and carcinomas)	Biodynamics 1995b Mixed Hexanes

^aThe number corresponds to entries in Figure 2-1.

^bUsed to derive a chronic-duration inhalation minimal risk level (MRL) of 0.6 ppm, based on a less serious LOAEL of 58 ppm for decreased motor nerve conduction velocity in humans. Concentration divided by an uncertainty factor of 100 (10 for use of a LOAEL and 10 for human variability).

^cExposure was to commercial hexane containing 51.5% n-hexane and the remainder other hexane isomers.

approx. = approximately; Bd Wt = body weight; Cardio = cardiovascular; CEL = cancer effect level; CNS = central nervous system; d = day(s); Endocr = endocrine; F = female; Gastro = gastrointestinal; Gd = gestational day; Hemato = hematological; hr = hour(s); LOAEL = lowest-observed-adverse-effect level; M = male; Metab = metabolic; MCV = motor nerve conduction velocity; mo = month(s); Musc/skel = musculoskeletal; NOAEL = no-observed-adverse-effect level; Resp = respiratory; wk = week(s); yr = year(s)

Figure 2-1. Levels of Significant Exposure to n-Hexane - Inhalation

Acute (≤14 days)

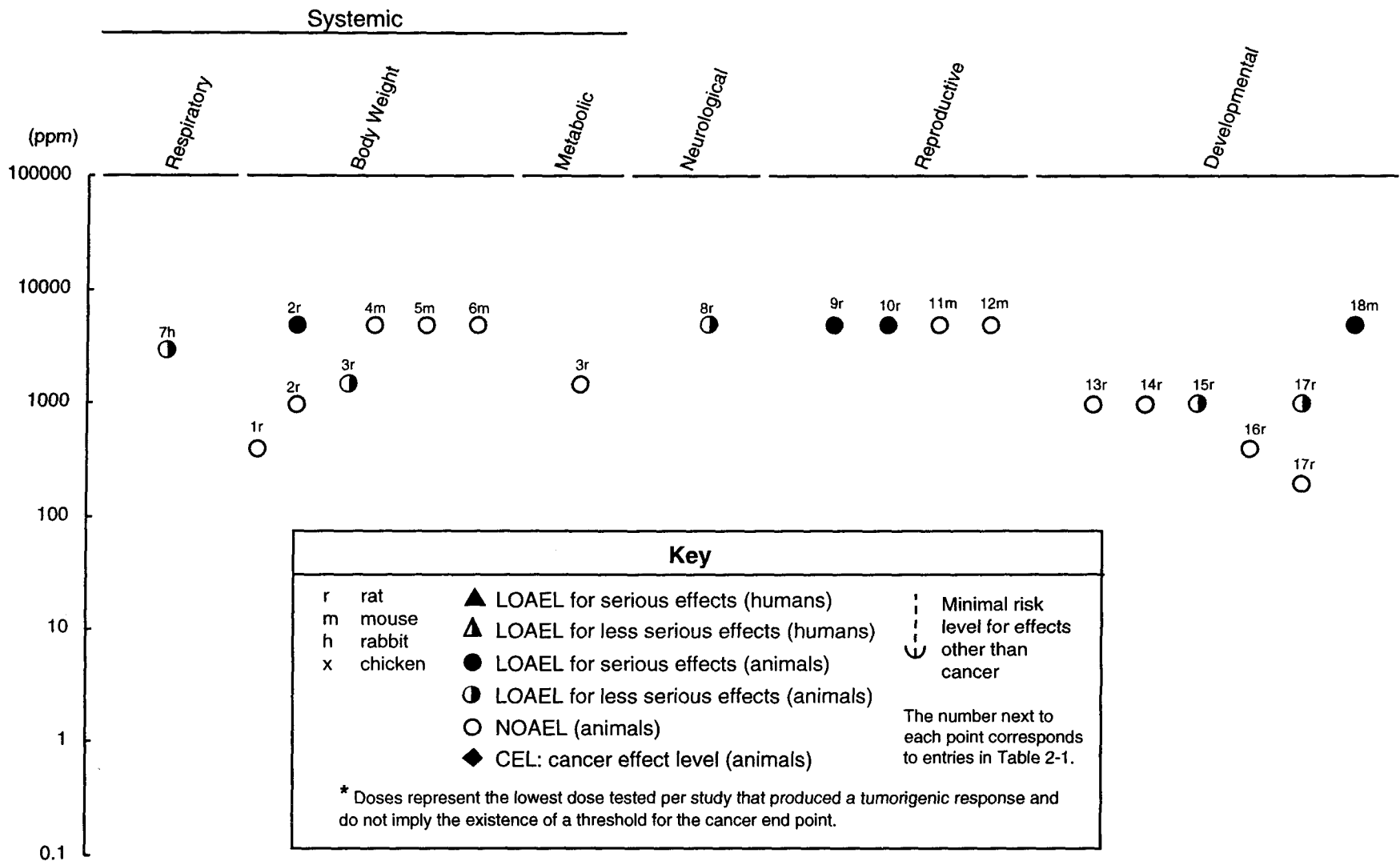

2. HEALTH EFFECTS

Figure 2-1. Levels of Significant Exposure to n-Hexane - Inhalation (cont.)
Intermediate (15-364 days)

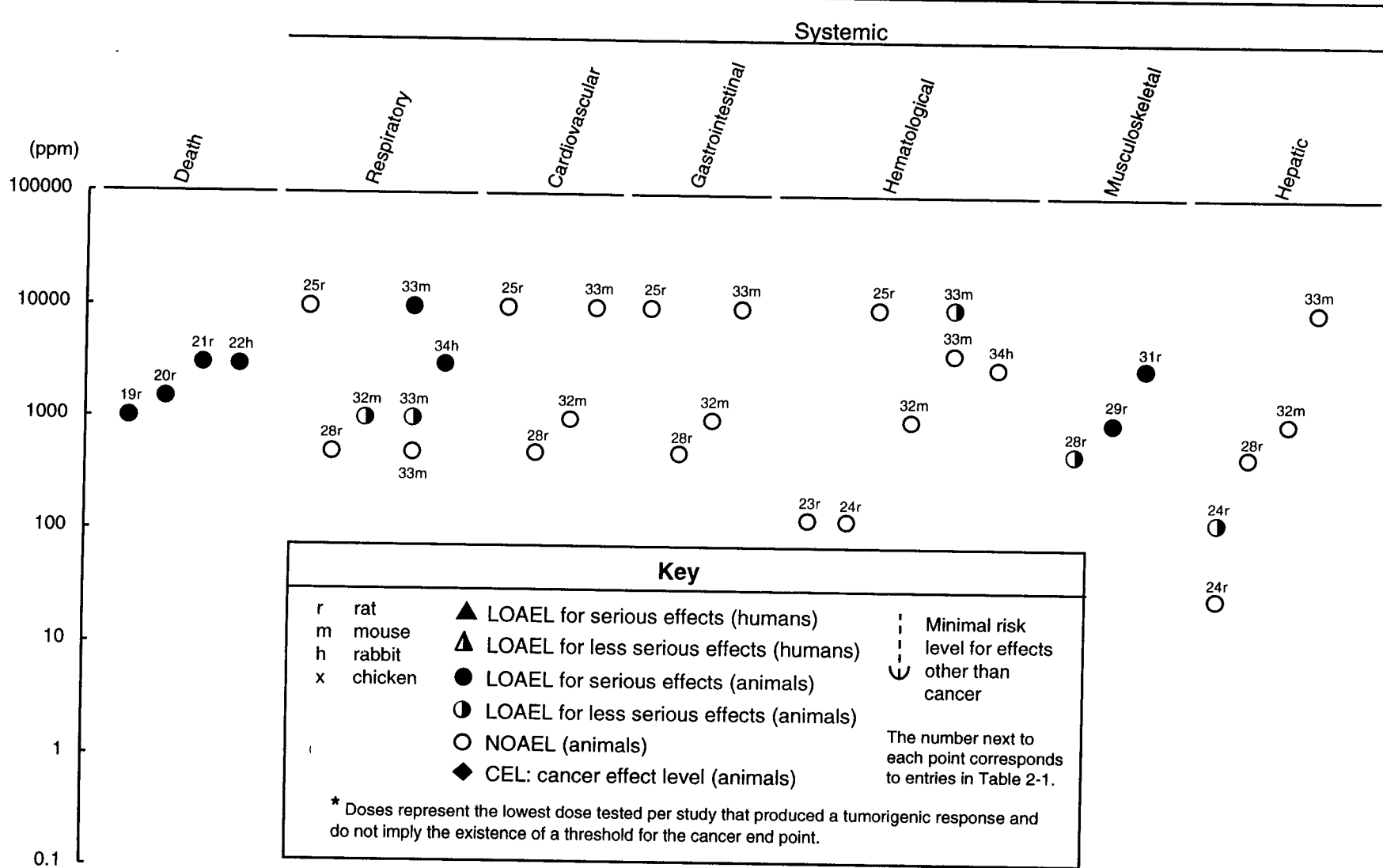
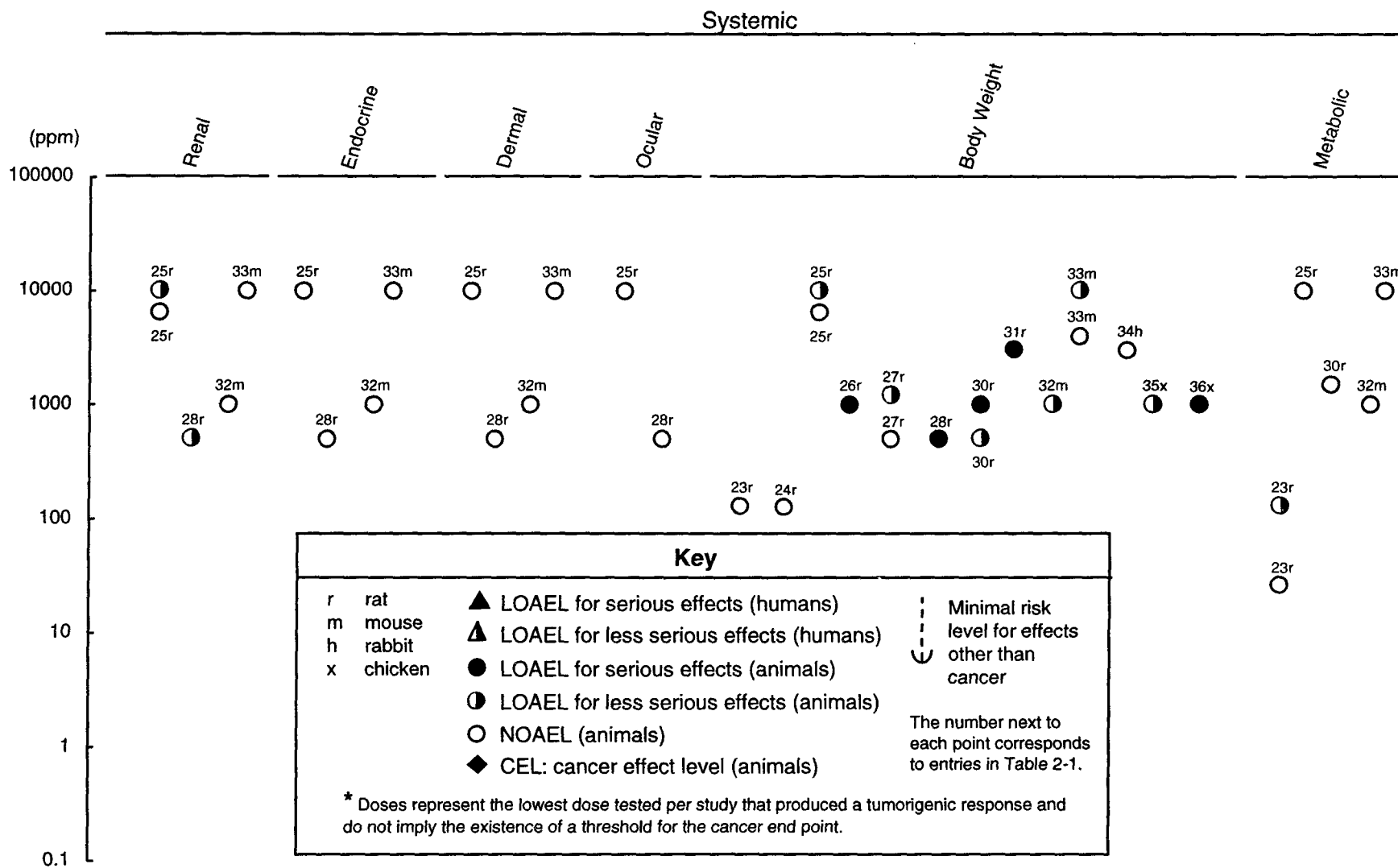

Figure 2-1. Levels of Significant Exposure to n-Hexane - Inhalation (cont.)

Intermediate (15-364 days)



2. HEALTH EFFECTS

Figure 2-1. Levels of Significant Exposure to n-Hexane - Inhalation (cont.)

Intermediate (15-364 days)

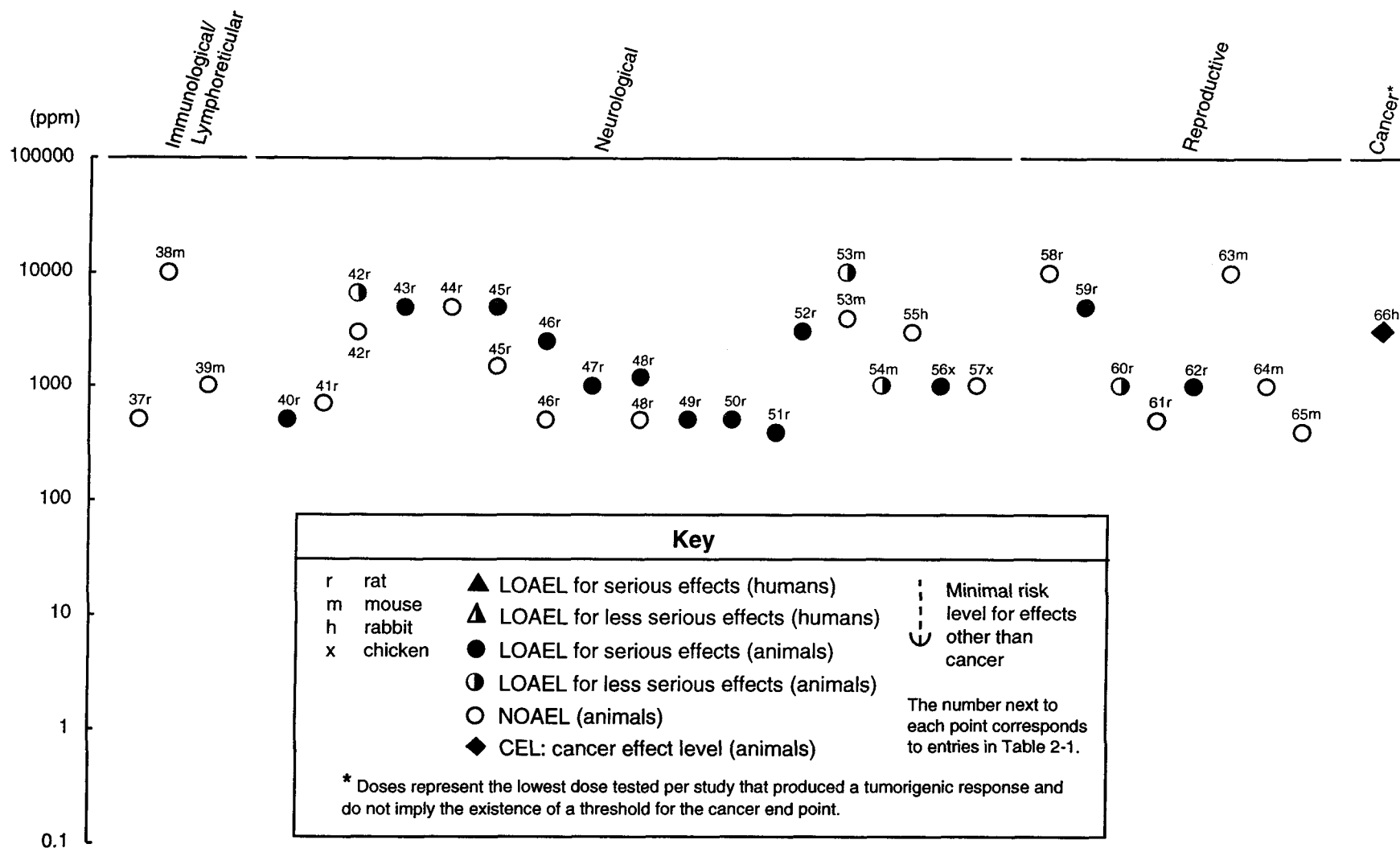
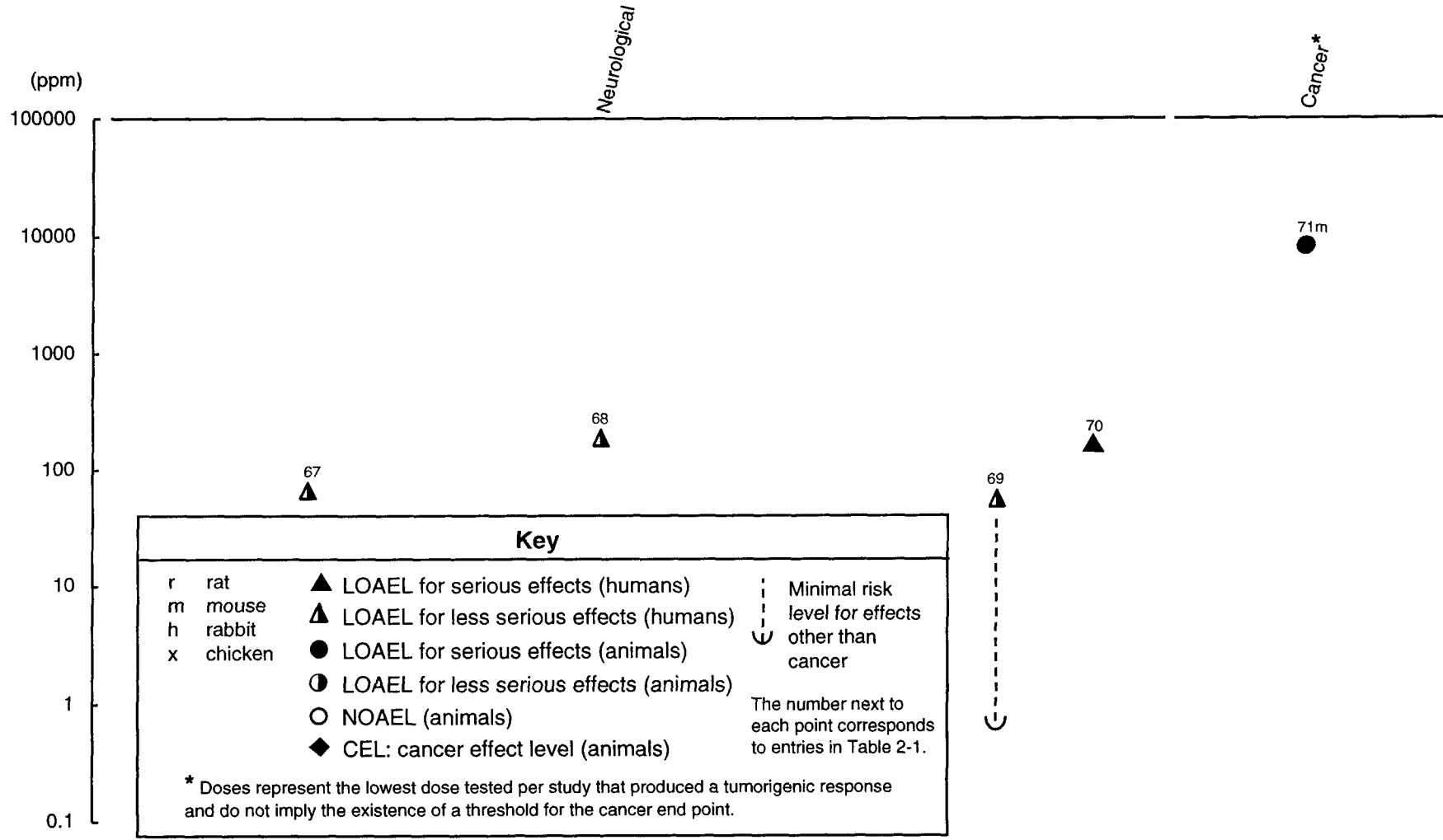

Figure 2-1. Levels of Significant Exposure to *n*-Hexane - Inhalation (cont.)
Chronic (≥ 365 days)



2. HEALTH EFFECTS

No information on respiratory effects after acute-duration inhalation exposure to *n*-hexane was located except a statement that male New Zealand rabbits exposed to 3,000 ppm 8 hours a day, 5 days a week for 24 weeks showed signs of respiratory tract irritation (nasal discharge) and breathing difficulties (gasping, lung rales, mouth breathing) throughout the study (Lungarella et al.1984).

More serious respiratory effects were seen upon histological examination of the respiratory tract at the end of this study. Gross lung changes observed in the rabbits included collapsed dark red areas, hyperemia, and the accumulation of mucous material. The trachea and the major bronchi showed areas of epithelial desquamation, relative atrophy, flattening of the mucosa, and foci of goblet cell metaplasia. The distal regions of terminal bronchioles and proximal portions of the alveolar ducts contained air space enlargements (consistent with centrilobular emphysema), scattered foci of pulmonary fibrosis, and papillary tumors of the bronchiolar epithelial cells. None of these alterations were found in the control rabbits. Two of 12 rabbits died during the study, possibly due to respiratory failure. To examine the reversibility of these effects, a group of 5 rabbits that had been kept for 120 days after exposure ceased were examined. No microscopic pathologic changes were visible in the mucosa of the trachea and the major bronchi except for small, scattered foci of goblet cell metaplasia. However, irregular foci of cellular proliferation and papillary tumors in terminal bronchiolar and alveolar ducts were observed.

Milder respiratory tract lesions resulting from inhalation *n*-hexane exposure were observed in 13-week exposure studies in male and female B6C3F₁ mice (Dunnick et al.1989; NTP 1991). In an intermittent exposure study (6 hours a day, 5 days a week), sneezing (a sign of respiratory tract irritation) was seen in both sexes at 10,000 ppm, beginning at week 4 and continuing until the end of the study. Multifocal regeneration and metaplasia in the olfactory epithelium were observed at 1,000 ppm. At 10,000 ppm, multifocal erosion, regeneration, inflammation, and metaplasia in both the olfactory and respiratory epithelium were observed. In a companion study where mice were exposed to 1,000 ppm *n*-hexane (22 hours a day, 5 days a week), mild multifocal regeneration and metaplasia in the olfactory epithelium were observed (Dunnick et al.1989; NTP 1991). No respiratory effects were observed in this study in mice exposed to 500 ppm *n*-hexane (6 hours a day, 5 days a week).

In other studies where histopathological examination of the respiratory tract was performed after inhalation of *n*-hexane, no lesions were noted in male Sprague-Dawley rats exposed to up to 500 ppm *n*-hexane for 22 hours a day, 7 days a week for 6 months (IRDC 1981) or in Fischer 344 rats of both sexes exposed to up to 10,000 ppm for 6 hours a day, 5 days a week for 13 weeks (Cavender et al.1984).

2. HEALTH EFFECTS

It should be noted that respiratory effects observed in these animal studies occurred at concentrations that are substantially higher than needed to cause neurotoxicity in rats (see Section 2.2.1.4). Thus, respiratory effects do not appear to be a sensitive indicator of *n*-hexane toxicity.

Cardiovascular Effects. Histopathological examination of the heart and aorta revealed no treatment-related lesions in male Sprague-Dawley rats exposed to up to 500 ppm *n*-hexane for 22 hours a day, 7 days a week for 6 months (IRDC 1981) or in Fischer 344 rats of both sexes exposed to up to 10,000 ppm for 6 hours a day, 5 days a week for 13 weeks (Cavender et al.1984). Similar results were noted in B6C3F₁ mice exposed to *n*-hexane at concentrations up to 10,000 ppm for 6 hours a day, 5 days a week for 13 weeks or 1,000 ppm for 22 hours a day, 5 days a week for 13 weeks (Dunnick et al.1989; NTP 1991). No other studies regarding cardiovascular effects after inhalation exposure to *n*-hexane in experimental animals were located.

Gastrointestinal Effects. Histopathological examination of gastrointestinal tissues (salivary glands, esophagus, stomach, small intestine [duodenum, jejunum, ileum], large intestine [cecum, colon, rectum], and pancreas) revealed no treatment-related lesions in male Sprague-Dawley rats exposed to up to 500 ppm *n*-hexane for 22 hours a day, 7 days a week for 6 months (IRDC 1981) or in Fischer 344 rats of both sexes exposed to up to 10,000 ppm for 6 hours a day, 5 days a week for 13 weeks (Cavender et al.1984). Similar results were noted in B6C3F₁ mice exposed to *n*-hexane at concentrations up to 10,000 ppm for 6 hours a day, 5 days a week for 13 weeks or 1,000 ppm for 22 hours a day, 5 days a week for 13 weeks (Dunnick et al.1989; NTP 1991). No other studies regarding gastrointestinal effects after inhalation exposure to *n*-hexane in experimental animals were located.

Hematological Effects. In a study where rats (12/sex/dose) were exposed to *n*-hexane for up to 6 months for either 6 hours a day, 5 days a week (0,6,26, or 129 ppm) or 21 hours a day, 7 days a week (0, 5, 27, or 126 ppm), some hematological parameters differed statistically from controls at 3 or 6 months (Bio/Dynamics 1978). Hematological analysis was performed in 4 animals in each group of 12. Among rats exposed for 6 hours a day, 5 days a week, mean hemoglobin and hematocrit values were within normal limits for all groups of males at 3 and 6 months. At 6 months, significantly increased leukocyte counts were observed in males at 6 and 129 ppm *n*-hexane, but not at 26 ppm. In females, hematocrit was reduced at 3 months at 6 and 26 ppm, but was elevated at 129 ppm. Erythrocyte counts were also lower at 6 and 26 ppm. Clotting time at 6 ppm was elevated at 3 months. No difference from control was seen in any female group at 6 months. None of the parameters measured in males or females was outside normal biological limits. Among rats exposed for 21 hours a day, 7 days a week, the only differences from control in hematological parameters seen in any group at 3 or 6 months were significantly lower erythrocyte counts

2. HEALTH EFFECTS

at 3 months at 5 ppm and a significantly depressed leukocyte count at 5 ppm at 6 months. None of the parameters measured in males or females was outside normal biological limits. Furthermore, when the 21 hours a day, 7 days a week experiment is compared to the 6 hours a day, 5 days a week experiment and the lack of a dose-response is considered, it is clear that there were no significant hematological effects in this study.

Hematological parameters were within normal limits in Fischer 344 rats (15/sex/dose) exposed to up to 10,000 ppm for 6 hours a day, 5 days a week for 13 weeks (Cavender et al.1984). Similarly, hematological parameters were within normal limits in B6C3F₁ mice (18/sex/dose) exposed to *n*-hexane at concentrations up to 10,000 ppm for 6 hours a day, 5 days a week for 13 weeks except for an increase in segmented neutrophils in males exposed to 10,000 ppm. The authors ascribed this to chronic active inflammation in the nasal mucosa of some of the male mice (Dunnick et al.1989; NTP 1991). In mice in this study exposed to 1,000 ppm *n*-hexane for 22 hours a day, 5 days a week for 13 weeks, all hematological parameters were within normal limits. No significant changes were observed in hematological parameters in male New Zealand rabbits (n=12) exposed to 3,000 ppm *n*-hexane 8 hours a day, 5 days a week for 24 weeks (Lungarella et al.1984). No other studies examining hematological effects after inhalation exposure to *n*-hexane were located.

Musculoskeletal Effects. Muscle wasting and atrophy have been reported in humans occupationally exposed to *n*-hexane (Yamamura 1969). These effects occurred in individuals with severe neurotoxicity.

Muscle atrophy is a common finding after intermediate-duration inhalation exposure to *n*-hexane in experimental animals. This atrophy is secondary to *n*-hexane-induced neurotoxicity which results in muscle denervation (see Section 2.2.1.4). Hindlimb atrophy characterized as “severe” was reported in 10 of 11 male Sprague-Dawley rats exposed to 986 ppm *n*-hexane for 28 or 61 days (Nylen et al.1989). Mild atrophy of the gastrocnemius muscle was observed in 3 of 10 male Sprague-Dawley rats exposed to 500 ppm *n*-hexane for 22 hours a day for 7 days a week for 6 months (IRDC 1981). Degenerative changes in the muscle were not observed. Electron microscopy of the gastrocnemius and soleus muscles in male Wistar rats exposed to 3,040 ppm *n*-hexane for 12 hours a day, 7 days a week for 16 weeks, revealed denervation, irregular fibers, disordered myofilaments, zig-zagging of the Z-band, and numerous invaginations of the plasma membrane (Takeuchi et al.1980).

Hepatic Effects. Decreased blood urea nitrogen, indicating an effect on protein catabolism, was noted in female, but not male, Sprague-Dawley rats (12/sex/dose, 4 analyzed per group) exposed to 126 ppm *n*-hexane for 21 hours a day, 7 days a week for 26 weeks (Bio/Dynamics 1978). Histopathological

2. HEALTH EFFECTS

examination of the liver after intermediate-duration inhalation exposure revealed no treatment-related lesions in male Sprague-Dawley rats (n=20) exposed to 500 ppm *n*-hexane daily for 6 months, 22 hours a day (IRDC 1981); or in Fischer 344 rats of both sexes (15/sex/dose, 10 examined per group) exposed to up to 10,000 ppm for 6 hours a day, 5 days a week for 13 weeks (Cavender et al.1984). Similar results were observed in B6C3F₁ mice (18/sex/dose, 8-10 examined per group) exposed to *n*-hexane at concentrations up to 10,000 ppm for 6 hours a day, 5 days a week for 13 weeks or 1,000 ppm for 22 hours a day, 5 days a week for 13 weeks (Dunnick et al.1989; NTP 1991).

Renal Effects. An increased incidence and severity of chronic nephropathy (a common age-related condition in male rats) was noted in male Sprague-Dawley rats (n=20, 10-11 examined) exposed to 500 ppm *n*-hexane daily for 6 months, 22 hours a day (IRDC 1981). Increased kidney weight was also observed. The authors stated that it was unclear whether the increased incidence and severity was due to exacerbation of the process seen in the control group or if the *n*-hexane exposure caused additional tubular injury. No lesions were reported in the urinary bladder. The authors did not investigate what role the unique male rat protein $\alpha_{2\mu}$ -globulin might be playing in these renal effects. Other substances that apparently bind to this carrier protein include a number of hydrophobic xenobiotics such as petroleum-derived hydrocarbons, including decalin and the gasoline constituent trimethylpentane. These substances cause an $\alpha_{2\mu}$ -globulin nephropathy syndrome in male rats (EPA 1991). A decrease of urine pH in male rats exposed to 10,000 ppm but no histopathological lesions in the kidney were reported in Fischer 344 rats of both sexes (15/sex/dose, 10 examined per group) exposed to up to 10,000 ppm *n*-hexane for 6 hours a day, 5 days a week for 13 weeks (Cavender et al.1984). Histopathological examination of the kidney and urinary bladder showed no treatment-related lesions in B6C3F₁ mice (1 g/sex/dose, 8-10 examined per group) exposed to *n*-hexane at concentrations up to 10,000 ppm for 6 hours a day, 5 days a week for 13 weeks or 1,000 ppm for 22 hours a day, 5 days a week for 13 weeks (Dunnick et al.1989; NTP 1991).

Endocrine Effects. Histopathological examination of endocrine tissues (thyroid, parathyroid, adrenals, pituitary, pancreas) after intermediate-duration inhalation exposure revealed no treatment-related lesions in male Sprague-Dawley rats exposed to 500 ppm *n*-hexane daily for 6 months, 22 hours a day (IRDC 1981) or in Fischer 344 rats of both sexes exposed to up to 10,000 ppm for 6 hours a day, 5 days a week for 13 weeks (Cavender et al.1984). Similar results were seen in B6C3F₁ mice exposed to *n*-hexane at concentrations up to 10,000 ppm for 6 hours a day, 5 days a week for 13 weeks or at 1,000 ppm for 22 hours a day, 5 days a week for 13 weeks (Dunnick et al.1989; NTP 1991). Tissues examined were the thyroid, parathyroid, adrenals, pituitary, and pancreas.

2. HEALTH EFFECTS

Dermal Effects. Coldness, reddishness, or roughness of the skin in the distal extremities was observed in 59.2% of 93 workers with peripheral neuropathy after occupational inhalation exposure to *n*-hexane (Yamamura 1969).

Histopathological examination of the skin after intermediate-duration inhalation exposure revealed no treatment-related lesions in male Sprague-Dawley rats exposed to 500 ppm *n*-hexane daily 22 hours a day for 6 months (IRDC 1981), or in Fischer 344 rats of both sexes exposed to up to 10,000 ppm for 6 hours a day, 5 days a week for 13 weeks (Cavender et al.1984). Similar results were seen in B6C3F₁ mice exposed to *n*-hexane at concentrations up to 10,000 ppm for 6 hours a day, 5 days a week for 13 weeks or 1,000 ppm for 22 hours a day, 5 days a week for 13 weeks (Dunnick et al.1989; NTP 1991).

Ocular Effects. Histopathological examination of the eye and optic nerve after intermediate-duration inhalation exposure revealed no treatment-related lesions in male Sprague-Dawley rats exposed to 500 ppm *n*-hexane 22 hours a day for 6 months (IRDC 1981); or in Fischer 344 rats of both sexes exposed to up to 10,000 ppm for 6 hours a day, 5 days a week for 13 weeks (Cavender et al.1984). Effects caused by direct contact of *n*-hexane vapor with the eye are discussed in Section 2.2.3 (Dermal Exposure).

Body Weight Effects. The body weights of male Fischer 344 rats exposed to 1,500 ppm *n*-hexane 24 hours a day, 5 days a week were 11% below those of control rats within 2 weeks (Rebert and Sorenson 1983). In a developmental study where pregnant Sprague-Dawley rats were exposed to *n*-hexane concentrations of 0, 93, and 409 ppm over gestation days 6-15, no effects on body weight of the dams were observed (Litton Bionetics 1979); however, reduced body weight gain was seen at 5,000 ppm (but not at 200 or 1,000 ppm) in pregnant rats exposed 20 hours a day during gestation days 6-19 (Mast et al.1987).

Effects on body weight are common during intermediate-duration exposure of rats to *n*-hexane and tend to occur prior to the development of neurotoxicity (see Section 2.2.1.4). In male Wistar rats exposed to 0, 500, 1,200, or 3,000 ppm *n*-hexane daily for 12 hours a day, body weight was lower in the treated groups from 4 weeks of exposure (Huang et al.1989). Significantly decreased grip strength was noted at 13 weeks and, at study termination (16 weeks), body weights in the 1,200 and 3,000 ppm groups were 13% less than control. In another study with male Wistar rats exposed daily to 3,040 ppm *n*-hexane, reduction in body weight compared to control was significant at 4 weeks, and final weight was 33% less than control at 16 weeks (Takeuchi et al.1980). In this study, reductions in nerve conduction velocity were observed at 4 weeks, and clinical signs of neurotoxicity occurred at 10 weeks. Similarly, Sprague-Dawley rats exposed to 500 ppm for 22 hours a day showed significant reduction in body weight compared to controls at 7 weeks and clinical signs of neurotoxicity at 16 weeks (IRDC 1981). At study termination

2. HEALTH EFFECTS

after 6 months, treated animals weighed 30% less than controls. Severe body weight effects were observed in male Fischer 344 rats exposed for 24 hours a day, 6 days a week for 11 weeks at 1,000 ppm (I?owd et al.1983). At the end of this study, the body weight of young adults (80 days old) was 54% below that of controls, and that of weanlings (20 days old) was 33% below control. The young adults in this study failed to gain any weight over the 11-week exposure. Body weight effects were concentration-related in male Fischer 344 rats exposed for 24 hours a day, 5 days a week (Rebert and Sorenson 1983). Body weight was 10% below control at 500 ppm and 20% below control at 1,000 ppm after 8 weeks.

Intermittent exposure has only mild effects on body weight even at high concentrations of *n*-hexane. In Fischer 344 rats exposed to up to 10,000 ppm for 6 hours a day, 5 days a week, the only effect seen after 13 weeks was a 11% decrease in body weight compared to controls in males, with no effect seen in females (Cavender et al.1984). No effect on body weight was observed in rats exposed 21 hours a day to 126 ppm or intermittently (6 hours a day, 5 days a week) to 129 ppm *n*-hexane for 26 weeks (Bio/Dynamics 1978).

Less-severe body weight effects were observed in species that are less susceptible to *n*-hexane-induced neurotoxicity (see Section 2.2.1.4). In male B6C3F₁ mice exposed to 1,000 ppm *n*-hexane for 22 hours a day, 5 days a week for 13 weeks, a 10% depression in the final body weight relative to control was observed (Dunnick et al.1989; NTP 1991). No change in weight was found in females. In male B6C3F₁ mice exposed to 10,000 ppm *n*-hexane for 6 hours a day, 5 days a week for 13 weeks, a 17% depression in the final body weight relative to control was observed. NOAELs were 4,000 ppm in males and 10,000 ppm in females (Dunnick et al.1989; NTP 1991). No effect on body weight was observed in male New Zealand rabbits exposed to 3,000 ppm *n*-hexane for 8 hours a day, 5 days a week for 24 weeks (Lungarella et al.1984). Variable weight loss was observed in Leghorn chickens exposed to 1,000 ppm *n*-hexane continuously for 30 days (21%) and 90 days (12%) (Abou-Donia et al.1991). Weight loss was greatly exacerbated in the 90-day study (up to 35%) when chickens were exposed to both 1,000 ppm *n*-hexane and 1,000 ppm methyl isobutyl ketone.

Metabolic Effects. In studies where metabolic parameters (blood pH, electrolytes, glucose) were measured, no effects were seen after inhalation exposure to *n*-hexane in Fischer 344 rats at up to 10,000 ppm for 6 hours a day, 5 days a week for 13 weeks (Cavender et al.1984) or in B6C3F₁ mice similarly exposed (Dunnick et al.1989; NTP 1991). Significantly higher mean-fasting glucose was observed in male Sprague-Dawley rats (n=4) exposed for 6 hours a day, 5 days a week at 6 and 129 ppm, but not at 26 ppm (Rio/Dynamics 1978). Female fasting glucose levels were unaffected by exposure in this study. No effect on this parameter was seen in a parallel experiment at similar concentrations for 21 hours a day. For this reason, and because of the small group size (n=4), this finding is of doubtful toxicological

2. HEALTH EFFECTS

significance. Body temperature in rats was unaffected by continuous exposure to up to 1,500 ppm *n*-hexane after 2 and 11 weeks (Rebert and Sorenson 1983).

2.2.1.3 Immunological and Lymphoreticular Effects

One report of immunological effects in humans after exposure to *n*-hexane was located (Karakaya et al. 1996) describing a reduction in immunoglobulin levels in a group of 35 male workers compared to a control group of 23 (matched by age, other characteristics of the groups not reported). The reductions correlated with 2,5-hexanedione in urine but not with workplace *n*-hexane concentrations (23-215 ppm). The reductions also remained well within the normal ranges for immunoglobulins in blood, so the toxicological significance of these findings can not be assessed without confirmatory studies (Jackson et al. 1997). Cell counts (lymphocytes, neutrophils, monocytes, eosinophils) were unaffected by *n*-hexane exposure. No reports of dermal sensitization after exposure to *n*-hexane in humans were located.

Information on immunological/lymphoreticular effects in test animals is limited to histopathological examination of tissues after intermediate-duration inhalation exposure to *n*-hexane. No treatment-related lesions were observed in the cervical, bronchial, or mesenteric lymph nodes, thymus, bone marrow (sternum), or spleen of male Sprague-Dawley rats exposed to 500 ppm *n*-hexane 22 hours a day for 6 months (IRDC 1981) or in mandibular and mesenteric lymph nodes, thymus, bone marrow, or spleen of Fischer 344 rats of both sexes exposed to up to 10,000 ppm for 6 hours a day, 5 days a week for 13 weeks (Cavender et al. 1984). Similar results were observed in mesenteric lymph nodes, thymus, bone marrow (sternum), and spleen in B6C3F₁ mice exposed to *n*-hexane at concentrations up to 10,000 ppm for 6 hours a day, 5 days a week for 13 weeks or 1,000 ppm for 22 hours a day, 5 days a week for 13 weeks (Dunnick et al. 1989; NTP 1991).

The highest NOAEL values for immunological/lymphoreticular effects in each species and duration category are recorded in Table 2-1 and plotted in Figure 2-1.

2.2.1.4 Neurological Effects

The neurotoxicity of *n*-hexane was first observed in the shoe industries of Japan and Italy in the 1960s and early 1970s. A number of epidemiological studies were initiated in response to outbreaks of apparent peripheral neuropathy in shoe workers. While the clinical course of the disease was well described, elucidation of a dose-duration response relationship has been difficult. In most cases, concentrations of *n*-hexane

2. HEALTH EFFECTS

in the workplace air were not measured until after disease developed. Also, in almost all cases, workers were concurrently exposed to other chemicals which may have affected their response to *n*-hexane.

One of the first large epidemiological investigations carried out was a case series of 93 cases of peripheral neuropathy in workers exposed to *n*-hexane from glues and solvents used in sandal manufacture (Yamamura 1969). After several cases of advanced quadriplegia were noted in the Fukaya district, Mie prefecture, Japan, an epidemiological investigation was carried out. Medical examination was performed on 296 of 1,662 workers checked by questionnaire. Of this group, 93 cases of peripheral neuropathy (both sensory and motor) were diagnosed. Urinalysis, hematology and serum chemistry, electromyography, and nerve conduction tests were done on 42-44 of the 93 total cases. The group was composed of 21 males and 72 females with an average age of 40.6 years. On the basis of symptoms, the subjects were divided into 3 groups: Group I, sensory neuropathy only (53 cases); Group II, sensorimotor neuropathy (32 cases); and Group III, sensorimotor neuropathy with muscle atrophy (8 cases). The grade of disorder was dependent on working conditions (work hours, work load, vapor concentration in room). The authors stated that *n*-hexane concentrations in the patients' work areas (primarily the home) ranged from 500 to 2,500 ppm. Duration of exposure was not specifically mentioned although the case of 1 female who had been exposed for 8 months was described in detail. The most common initial symptom was numbness in the distal portions of the extremities (88%); the second most common was muscle weakness (14%). Major clinical findings were numbness (100%); muscle weakness (43%); hypoactive reflexes (38.7%); and coldness, reddishness, or roughness of the skin (59.2%). Pyramidal tract signs (indicating central nervous system effects) were not observed in any patient. All the cases in Group III showed a continuing increase in the severity of their conditions for 1-4 months after exposure ceased. A follow-up of 36 patients showed complete or near-complete recovery in 3-18 months, including 6 of 8 in Group II. Residual atrophy and muscle weakness were still present in 2 individuals from Group III. No fatalities occurred. Electromyography revealed the appearance of fibrillation voltages (indicating denervation) and positive sharp waves in 15.3 and 19.9% of examined muscles in groups II and III, respectively. In the median and ulnar nerves, reduction of motor nerve conduction velocity below 45 meters per second (msec) was observed in 22 and 16 cases, respectively. In the tibial nerve, motor nerve conduction velocity was reduced below 40 m/sec in 31 cases. In the peroneal nerve, the motor nerve conduction velocity was below 40 m/sec in 21 cases, and no response was obtained in 5 cases. The authors stated that reduction in motor nerve conduction velocity was greatest in Group III, followed by Group II and then Group I. Muscle biopsies of the anterior tibial muscle in 3 cases revealed atrophy of muscle fibers but no significant variation among groups. Myofibrils and striations were preserved and degenerative changes were minimal. Biopsies of peripheral nerve in 6 cases revealed "striking" demyelination and infiltration of leukocytes in

2. HEALTH EFFECTS

perivascular areas. Axonal degeneration was also present, although the authors stated that demyelination was the more obvious feature.

A case series of workers in a furniture factory in the Bronx, New York, illustrates the typical clinical presentation of *n*-hexane neurotoxicity (Herskowitz et al. 1971). This report describes the cases of 3 women who worked as cabinet finishers wiping glue off furniture with rags soaked in a solvent which contained *n*-hexane. An open drum of this solvent was used in a small, poorly ventilated room. Air measurements of *n*-hexane averaged 650 ppm, although peaks of up to 1,300 ppm also occurred. The number of measurements was not reported. Neurological signs of both motor and sensory impairment were noted in all 3 women with an onset 2-4 months after beginning employment. Initial symptoms and clinical findings were similar in all three women. In the first case (a 23-year-old woman), initial symptoms were a burning sensation in the face, numbness of the distal extremities, and an insidious, progressive distal symmetrical weakness in all extremities. Frequent headaches and abdominal cramps were also reported. After being admitted to the hospital (6 months after beginning work), muscle testing revealed a moderate distal symmetrical weakness and a bilateral foot-drop gait. There was a moderate decrease of pin and touch perception and mild impairment of vibration and position sense in the lower extremities. Tendon reflexes were slightly hyperreflexic (1+) and symmetrical throughout, except for absent Achilles tendon reflexes. No Babinski sign (indicating central nervous system toxicity) was present. A complete blood count, blood urea nitrogen, fasting blood sugar, electrolytes, liver-function tests, transaminases and enzymes, and thyroxine levels were within normal limits. Serum lead screening was also negative. An electromyogram revealed fibrillation potentials in the small muscles of the hands and feet. Nerve conduction velocities were 45 m/s in the left ulnar nerve (normal range in the general population, 49-75), 26 m/s in the right median nerve (normal range, 50-75), and 23 m/s in the left peroneal nerve (normal range, 40-60). Sural nerve biopsy was unremarkable, although electron microscopic examination showed a few myelinated axons containing dense bodies and exceptionally numerous mitochondria. Muscle biopsy showed scattered groups of small angulated fibers and many fibers with clear central zones, consistent with denervation. Electron microscopy of nerve branches within the muscle showed an increased number of neurofilaments with abnormal membranous structures and clumping and degeneration of mitochondria with dense bodies. Increased numbers of mitochondria, glycogen granules, and degenerated mitochondria were noted in the motor endplates.

In a study where exposure appeared to be limited to only *n*-hexane and acetone, 2 age-matched groups consisting of 14 control workers and 14 exposed workers employed in a factory producing tungsten carbide alloys were compared (Sanagi et al. 1980). The groups were matched with respect to age, stature, weight, alcohol consumption, and smoking habits. Exposure was estimated with 22 personal samples taken from

2. HEALTH EFFECTS

the breathing zones over a period of 2 years (this number of samples is fewer than optimal for measuring air levels). Eight-hour time-weighted average exposure to solvent vapors consisted of *n*-hexane at 58 ± 41 ppm and acetone at 39 ± 30 ppm; no other solvent vapors were detected. The exposure duration ranged from 1 to 12 years with an average of 6.2 years. Both groups completed questionnaires and underwent clinical neurological examinations with reference to cranial nerves, motor and sensory systems, reflexes, coordination, and gait. Neurophysiological studies performed included electromyography on muscles of the forearm and leg. Nerve stimulation studies were performed with a surface electrode (motor nerve conduction velocity, residual latency). Conduction velocities and distal latencies in the control group were similar to those reported in other studies (Goodgold and Eberstein 1983; Johnson et al. 1983). In the questionnaire, only the prevalence of headaches, dysesthesia of limbs, and muscle weakness was higher in the exposed group compared to the control; complaints of hearing deficits which were thought to be related to noise from ball mills were also greater in the exposed group. Cranial nerve examinations and motor and sensory nerve examinations did not reveal any statistically significant abnormal neurological signs; however, paresthesia of the extremities was observed in 3 exposed workers and 1 worker in the control group. Differences ($p < 0.05$) in the jump test (muscle strength) and the tuning fork test (vibration sensation) were noted. A general trend of diminished muscle strength reflexes was found in the biceps and knees of exposed workers; however, the difference was not statistically significant. Significant differences in the nerve conduction velocities of the right median, ulnar, and posterior tibial nerves were not found. However, a statistically significant decrease was detected in the posterior tibial nerve. An increased residual latency (time from onset of stimulus to recording) of motor conduction and decreased maximal motor nerve conduction velocities were reported in the exposed workers. Residual latency was 2.21 ± 0.34 m&c in controls versus 2.55 ± 0.48 m/sec in exposed subjects; maximal motor nerve conduction velocity was 48.3 ± 2.1 m/sec in controls versus 46.6 ± 2.3 m/sec in exposed subjects. Normal values for the posterior tibial nerve have been reported as 2.1-5.6 m/sec for distal latency and 44.8-51.2 m/sec for conduction velocity (Goodgold and Eberstein 1983). The subjects in this study were age matched because these parameters vary with increasing age (conduction velocity decreases and distal latency increases).

It is not entirely clear whether the acetone co-exposure in the Sanagi et al. (1980) study contributed to the observed effects. Indirect evidence from an occupational study (Cardona et al. 1996) showed that workplace acetone concentrations had a statistical correlation with the ratio of urinary *n*-hexane metabolites to *n*-hexane air concentration, although it did not correlate with measured urinary metabolites. No animal studies are available describing the effects of inhalation co-exposure to acetone and *n*-hexane, although there are several studies which report interactions between acetone and the neurotoxic metabolite of *n*-hexane, 2,5-hexanedione, by the oral route (See Section 2.4, Mechanisms of Action). Oral administration of acetone has been reported to potentiate the neurotoxicity caused by oral exposure to

2. HEALTH EFFECTS

2,5-hexanedione in rats (Ladefoged et al.1989, 1994). Oral exposure to acetone alone in rats at 650 mg/kg/day resulted in a statistically significant decrease in motor nerve conduction velocity after 6 weeks; co-exposure to acetone and 2,5-hexanedione resulted in greater effects than those seen with 2,5-hexanedione alone (Ladefoged et al.1989). It is possible that acetone may potentiate *n*-hexane neurotoxicity by decreasing body clearance of 2,5-hexanedione (Ladefoged and Perbellini 1986). Simultaneous subcutaneous injection of acetone and 2,5-hexanedione increased the peak concentration of 2,5-hexanedione in rat sciatic nerve compared to injection of 2,5-hexanedione alone (Zhao et al.1998). Acetone also influences the action of many chemicals by its induction of the cytochrome P-450 isozyme CYP2E1 (Patten et al.1986). *n*-Hexane is metabolized by P-450 isozymes (see Section 2.4); induction by acetone may result in an increased production of the neurotoxic metabolite 2,5-hexanedione.

In a cross-sectional study of press-proofing workers in Taipei resulting from the diagnosis of 2 workers with peripheral neuropathy, a total of 59 workers from 16 press-proofing factories were examined (Wang et al.1986). Criteria for inclusion in the study were not specified. Exposure to *n*-hexane-containing solvents occurred during a cleaning process. The mean age of the workers was 25.8 years; the employment duration ranged from 2 months to 25 years, with a mean of 5.8 years. The workers were interviewed to obtain demographic information and occupational and medical histories. Neurological examinations of the workers (57 male and 2 female) were conducted. These examinations included the evaluation of motor reflexes, muscle strength, and sensory function. In addition, nerve conduction velocity studies were conducted in 54 of the 59 workers. The authors defined polyneuropathy as the presence of objective signs (the inability to walk-*on*-heels and/or walk-*on*-toes) plus at least one abnormally slow conduction velocity in both the upper and the lower extremities or two abnormally slow nerve conduction velocities in the lower extremities. Age-matched controls were not used in this study; an “abnormally low conduction velocity” was defined as less than 45 m/sec in the upper extremities and less than 40 m/sec in the lower extremities. Of the 59 workers examined, 15 (25%) were diagnosed with neuropathy. Among the individuals with neuropathy, the duration of employment ranged from 7 months to 5 years. There were 3 factories where workers had polyneuropathy; 8 of these workers were from a factory which had since been closed, so no air measurements were possible. Two of these workers were from a factory where the measured *n*-hexane concentration was 22 ppm, but this is likely to be an underestimate since the door was open and ventilation fans were running, while the usual condition was a closed-off work area. Six of the workers with polyneuropathy worked in a factory where the measured *n*-hexane concentration was 190 ppm. In all cases, air samples were collected for a single random 1-hour period only, thus these estimates should be viewed with caution. In addition, most of these workers were exposed for more than 8 hours a day as a result of overtime; 12 of 13 who regularly slept in the factory had polyneuropathy compared to only 3 of 46 who slept elsewhere. No significant correlation between neuropathy and length of employment or age

2. HEALTH EFFECTS

was found. Chemical analysis showed that *n*-hexane, ranging in content from 10 to 65%, was present in solvents in all 16 factories. Other chemicals known to cause neurotoxicity (acrylamide, tri-*ortho*-cresyl phosphate, methyl *n*-butyl ketone, mercury, carbon disulfide, manganese) were not present in significant amounts. All cases of neuropathy occurred in factories using solvents with $\geq 50\%$ *n*-hexane. The sural nerve biopsies of three diagnosed individuals showed axonal degeneration and secondary changes in the myelin sheath, which are compatible with toxic neuropathy. Decreased motor nerve conduction velocities were observed in some workers exposed to less than 100 ppm *n*-hexane.

An outbreak of peripheral neuropathy in an offset printing factory in Hong Kong provides information on possible sensitive indicators of *n*-hexane neurotoxicity (Chang et al. 1993). In this incident, 20 of 56 employees developed peripheral neuropathy after exposure to solvents containing *n*-hexane. Mean air measurements of *n*-hexane (taken after the outbreak began) were 63 ppm (range, 30-110 ppm) in the plant and 132 ppm (range, 80-210) for personal air samples from the machine operators. The work period was 12 hours a day, 6 days a week. Clinical signs were similar to those seen in other cases of *n*-hexane neurotoxicity; of the 36 remaining asymptomatic workers, 26 had abnormalities on nerve conduction tests (conduction velocity, distal latency, potential amplitude) and were considered to have a subclinical peripheral neuropathy. In the 10 "healthy" workers, a significantly reduced amplitude of sensory action potentials was observed compared to a control group of 20 unexposed individuals. Other parameters measured (motor action potential amplitude, motor and sensory nerve conduction velocities) were similar between the groups.

A decrease in the amplitude of the sensory nerve action potential has also been observed in a group of 20 asymptomatic workers exposed to *n*-hexane (Pastore et al. 1994). The subjects of this study were selected on the basis of urinary levels of the *n*-hexane metabolite 2,5-hexanedione (See Sections 2.3 and 2.7) exceeding 5 mg/L and compared to a group of unexposed laboratory workers. Mean years worked was 8.13 (range, 1.5-23 years). Sensory and motor nerve conduction velocities and distal latencies were normal in all nerves tested. However, significant decreases were found in sensory nerve action potential amplitude in the median, sural, and ulnar nerves. Neither the level of 2,5-hexanedione in urine nor age correlated with the changes in amplitude; however, there was a significant correlation between years worked and amplitude.

Differential effects on large myelinated fibers (fast-conducting) and small myelinated fibers (slowconducting) have also been observed after exposure to *n*-hexane (Yokoyama et al. 1990). Three workers, 23-27 years old, developed peripheral neuropathy after being exposed to *n*-hexane in the workplace for approximately 6 months. A single measurement of air *n*-hexane was 195 ppm; individual near-face

2. HEALTH EFFECTS

sampling on each worker was not done. Neurological exams were performed on the workers, and the distribution of conduction velocities in the sensory sural nerve was measured. This technique simulates individual fiber action potentials from the compound action potential from the nerve, giving a distribution of velocities. This distribution shifted to lower velocities when compared to a group of control subjects (11 males, aged 23-40; mean age, 32). Sural nerve biopsy in one patient 10 weeks after cessation of exposure showed a decrease in large myelinated fibers and a mild decrease in small myelinated fibers, confirming the conduction velocity distribution results. Teased fiber preparations showed paranodal swellings, retracted myelin, and focal demyelination.

In another cross-sectional study, possible central nervous system effects of inhalation exposure to *n*-hexane were examined in workers exposed to *n*-hexane-containing glues or *n*-hexane-containing solvents used in vegetable oil extraction (Seppalainen et al.1979). Concentrations of *n*-hexane in workers' breathing zones were not stated. Visual evoked potentials (VEPs) and averaged extraocular electroretinograms (ERGS) were recorded from 15 workers occupationally exposed to *n*-hexane for 5-21 years and from 10 healthy controls. (In this type of study, a visual stimulus is presented and the resulting electrical activity in the brain is measured with scalp electrodes.) Of the subjects, 11 were male and 4 female, the mean age was 46, and the mean exposure to *n*-hexane was 12 years (range, 5-21 years). The mean age of the control subjects was 34.9 years. Each peak of the VEP recording was designated by standard symbols and peak amplitude measured. The amplitude of the VEP components was significantly smaller among the exposed subjects compared with controls with the exception of N0, which tended to be larger. In addition, the latencies of P1 and N1 were longer among the exposed workers, while that of P2 was slightly shorter. The peak-to-peak amplitude of the ERGS was also diminished among the exposed subjects. This study is limited by the small number of subjects. Also the control group was on average 11 years younger than the exposed group.

Several studies have demonstrated sub-clinical alteration in neurological function after inhalation exposure to *n*-hexane. In a cross-sectional study using age-matched controls, workers in a shoe factory exposed to *n*-hexane were compared to a control group, which had not been exposed, from the same factory (Mutti et al.1982a, 1982c). The control group consisted of 12 males and 40 females with a mean age of 29.6 years and employment time of 10.2 years. The exposed group was composed of 24 males and 71 females with a mean age of 30.9 years and employment time of 9.1 years. The exposed group was divided into a mild and high-exposure group on the basis of time-weighted average breathing-zone air samples (a total of 108 samples were taken over a 2-year period). The participants were surveyed for neurological symptoms

2. HEALTH EFFECTS

and motor nerve action potential amplitude, and duration; and motor nerve conduction velocities were measured in the median, ulnar, and peroneal nerves. Mean breathing-zone *n*-hexane air concentrations were 69 ppm in the mild-exposure group and 134 ppm in the high-exposure group. Cyclohexane, methyl ethyl ketone, and ethyl acetate were also detected. Methyl ethyl ketone (which appears to potentiate *n*-hexane neurotoxicity in both humans and test animals [Altenkirch et al.1977, 19821) concentrations were 22 ppm in the mild-exposure group and 76 ppm in the high-exposure group. Symptoms more frequent during the workday in the exposed than the control group were sleepiness and dizziness. Chronic symptoms more frequent in the exposed group were weakness, paraesthesia, and hypoesthesia. Motor action potential amplitude in all three examined nerves was significantly decreased compared to controls in both exposed groups. Motor nerve conduction velocity was significantly decreased in median and peroneal nerves, but not in the ulnar nerve. In the median nerve, motor nerve conduction velocity was significantly decreased in the high-exposure group compared to the mild-exposure group.

A group of 15 women from a shoe factory (mean age 26.6 years, mean exposure time 4.5 years) was compared to a control group of 15 healthy age-matched women from other shoe factories who had not been exposed to neurotoxic chemicals (Mutti et al.1982b). Measurements included motor conduction velocity of the median, ulnar, and peroneal nerves, and distal sensory conduction velocity of the median and ulnar nerves. In addition, somatosensory-evoked potentials in the brain were measured by two monopolar needle electrodes inserted into the scalp. Potentials were evoked by stimulation of the median nerve at the wrist. The mean time-weighted average *n*-hexane air concentration was 195 ppm for 36 samples taken over a 3-year period in the factory; methyl ethyl ketone concentration was 60 ppm. The authors stated that these concentrations had been substantially reduced 3 months earlier when industrial hygiene had improved and *n*-hexane had fallen to "trace" amounts at the time the conduction measurements were taken. All nerve conduction velocities (motor and sensory) were significantly slowed in exposed workers compared to controls. Sensory nerve action potential peak latency (time from onset of sensory stimulus to peak response at point of measurement) was significantly higher in the median and ulnar nerves of the exposed workers. Ten workers had one or more nerve conduction velocities or sensory peak latencies more than two standard deviations from the mean. Nerve conduction velocities were age-dependent in the control group, but not in the exposed group. The somatosensory-evoked potential recording could be broken down into 10 peaks; significantly greater latency was observed for the first 2 peaks in the exposed group compared to the controls. There was a negative linear relationship between distal sensory conduction velocity and latency of the earliest evoked potential (P15).

2. HEALTH EFFECTS

In a follow-up study, a group of 90 shoe manufacturing workers (27 men and 63 women) diagnosed in the past with *n*-hexane polyneuropathy were studied again at least 1 year after cessation of *n*-hexane exposure (Valentino et al.1996). Subjects were referred by the Italian government to confirm disability status and thus may not be representative of all those originally diagnosed. Urinary 2,5-hexanedione levels were analyzed in the urine in more than half of the workers to confirm that *n*-hexane exposure had ceased. Subjects were classified on the basis of the duration of time since the diagnosis. Group A was made up of 63 subjects who were studied after a period shorter than 10 years (mean, 4.5 years), with a mean duration of exposure of 8.9 years. Group B was made up of 27 subjects who were studied after a period longer than 10 years (mean 12.9 years), with a mean duration of exposure of 9.2 years. At the time of the follow-up clinical and neurophysiological evaluation, the mean age of subjects in group A was 44.4 years (SD 14.1) and the mean age of subjects in Group B was 52.9 years (SD 5.2). A control group of 18 men and 20 women with a mean age of 38.8 years (SD 4.9) was used (Group C). Groups A and B were not significantly different with respect to symptoms related to polyneuropathy. Paresthesia and weakness in legs or arms were reported by 22% and 28% of Group A subjects, respectively, and by 28% and 35% of Group B subjects, respectively. The percentage of subjects with abnormal leg deep tendon reflexes (knee, ankle), leg cutaneous sensitivity or vibration sensation, and arm vibration sensation was statistically higher in subjects who had ceased *n*-hexane exposure for less than 10 years than in the other subjects. No differences were found between Group A and Group B for arm deep tendon reflexes and arm cutaneous sensation, or in electrophysiological parameters. Motor nerve conduction velocities and distal latencies had improved from those observed at the time of diagnosis and were similar to the control group. However, sensory nerve conduction velocities and distal latencies, while improved from those at diagnosis, were still statistically different from controls.

In studies with test animals, signs of narcosis (prostration, coma) and incoordination have been reported in male Long-Evans rats exposed for 4 hours to a C6 aliphatic hydrocarbon fraction containing only *n*-hexane and its isomers (Hine and Zuidema 1970). One rat exposed at 81,800 ppm had convulsions during and after exposure and eventually died during the sixth day. Rats that survived recovered within a few hours after removal from the chamber. Motor nerve conduction velocity was significantly decreased as early as 1 week into treatment (11% less than control litter mates) in male Sprague-Dawley rats exposed to 5,000 ppm *n*-hexane for 16 hours a day, 6 days a week for 6 weeks (De Martino et al.1987). Mean reductions ranging from 20 to 34% were seen from the second to the fourth week. Between four and six weeks of treatment, clinical signs of neurotoxicity became evident in most animals. No other studies

2. HEALTH EFFECTS

describing neurological effects in experimental animals after acute-duration inhalation exposure to *n*-hexane were located.

Signs of neurological toxicity similar to those seen in humans after inhalation exposure to *n*-hexane have been observed in many intermediate-duration studies with rats. In Sprague-Dawley rats (sex not specified) exposed continuously to 400-600 ppm *n*-hexane for up to 162 days, animals developed an unsteady, waddling gait after 45-69 days of exposure (Schaumburg and Spencer 1976). Further exposure resulted in a progressive, symmetrical, distal hindlimb weakness with foot-drop. Severely affected animals also developed distal weakness of the upper extremities. Pathological changes, including giant axonal swellings and fiber degeneration, were detected in the peripheral and central nervous systems of the 4 animals exposed for 49 days. The changes were most striking in tibial nerves supplying calf muscles and in selected areas of the cerebellum, medulla, and spinal cord. In contrast to the usual picture associated with dying-back disease, the distal regions of proximal nerve fibers supplying calf muscles degenerated before equivalent regions of longer fibers supplying the hindfeet. Electron microscopic examination showed the swollen regions contained densely packed masses of 10 nm neurofilaments. Groups of mitochondria and neurotubules were displaced to the periphery of the axon or segregated into bundles.

The sequence of events in *n*-hexane-induced neuropathy has been described in rats (Spencer and Schaumburg 1977a). The process appears to begin by increases in the number of 10 nm axonal neurofilaments and accumulation in swellings on the proximal sides of the nodes of Ranvier in distal regions of large myelinated fibers. As exposure continues, there is a retrograde spread of axonal swellings up the nerve and smaller myelinated and unmyelinated fibers became involved. The nerve terminal is unaffected until late in the process. The enlarged axons displace the paranodal myelin sheaths leaving denuded swellings in areas near the nodes of Ranvier. This process occurs before functional impairment is evident, and can be reversed on cessation of exposure as swelling diminishes and proliferation of Schwann cells occurs at these sites with subsequent remyelination of the axons. If exposure to *n*-hexane continues, axonal restoration and remyelination do not take place at some swellings, and the length of the nerve fiber between the swelling and the terminal undergoes breakdown, very similar to that seen when fibers are transected. Axon sprouting is often seen at the intact portion of a degenerated fiber even while intoxication continues. When intoxication ends, this regenerative process can reestablish motor and sensory function.

The nerve fibers most vulnerable to *n*-hexane exposure in rats were the branches of the tibial nerve serving the calf muscles, followed in order by the plantar nerve branches supplying the flexor digitorum brevis

2. HEALTH EFFECTS

muscle, and then sensory plantar nerve branches innervating the digits. As intoxication continued, axonal degeneration ascended the plantar and tibial nerves (Spencer and Schaumburg 1977b). Examination of control animals indicated that the most sensitive fibers were also the largest. Effects on the central nervous system have also been observed in rats exposed to *n*-hexane or its neurotoxic metabolite, 2,5-hexanedione. Axonal swelling and degeneration were observed in the anterior vermis, spinocerebellar tract in the medulla oblongata, and gracile tracts of the spinal cord (Spencer and Schaumburg 1977b).

The neurotoxicity of “pure” *n*-hexane (99%) has been compared to “mixed hexanes” (a mixture containing the *n*-hexane isomers 2-methylpentane, 3-methylpentane, cyclohexane, methyl cyclopentane, and 2,3-dimethyl butane with approximately 1% *n*-hexane) (IRDC 1981). The mixture was intended to be more representative of products used commercially. In this experiment, groups of Sprague-Dawley rats were exposed to *n*-hexane alone (500 ppm), mixed hexanes (494 ppm) or *n*-hexane plus mixed hexanes (992 ppm) daily for 6 months, 22 hours a day. No deaths occurred as a result of treatment. Body weight declines were observed in both groups exposed to *n*-hexane, but not in the mixed-hexanes group, and first became significant at 7 weeks in the *n*-hexane-alone group. Gait disturbance developed in both *n*-hexane-treated groups, the earliest incidence was at week 16 in the *n*-hexane-alone group. Exposure to *n*-hexane either alone or in combination with mixed hexanes for 6 months produced neuronal atrophy with secondary skeletal muscle atrophy. In the *n*-hexane-alone group, the incidence of “trace/mild” peripheral nerve atrophy was 14 of 16 as opposed to 0 of 8 in controls. In the group treated with both *n*-hexane and mixed hexanes, the incidence of “trace/mild” peripheral nerve atrophy was 8 of 17. Axonal degeneration was not observed in either group. No clinical or histopathological signs of neurotoxicity were noted in the group exposed to mixed hexanes alone. No histopathological lesions were observed in any group in the brain, spinal cord, or neuroganglia (lumbar, sacral, dorsal).

In a study comparing continuous to intermittent exposure, male Wistar rats exposed to 500 or 700 ppm *n*-hexane 22 hours a day for 9 weeks showed signs of narcosis (Altenkirch et al. 1982). All exposed animals developed limb weakness beginning in the hindlimbs, leading to paralysis, and eventually to quadriplegia. Complete hindlimb paralysis was exhibited in the ninth week by all animals exposed to 500 ppm hexane. Animals exposed to 700 ppm *n*-hexane exhibited hindlimb paralysis in the fourth week of exposure. Light-microscopic examination of peripheral nerves revealed characteristic patterns of scattered multifocal giant axonal swellings localized primarily in the branches of the tibial nerve supplying the calf muscles and also in other portions of the ischiatic nerve. Breakdown of axons and myelin degradation were also visible distal to axonal swellings. Axonal swellings were also observed in the gracile tract

2. HEALTH EFFECTS

of the spinal cord at cervical levels. In experiments where animals were co-exposed to *n*-hexane and methyl ethyl ketone, the onset of clinical and pathological changes occurred earlier than in animals exposed to *n*-hexane alone. In contrast to these results, daily exposure at 700 ppm for up to 40 weeks, but for only 8 hours a day, did not result in clinical signs of neurotoxicity (Altenkirch et al.1982).

In an extensive toxicological study of *n*-hexane inhalation exposure in the rat (Cavender et al.1984), no significant differences from controls were noted in neurological function for either sex in Sprague-Dawley rats exposed up to 10,000 ppm *n*-hexane for 6 hours a day, 5 days a week for 13 weeks. Assessments included posture, gait, tone and symmetry of the facial muscles, and an examination of reflexes (pupillary, palpebral, extensor thrust, and cross-extensor thrust). Brain weights were significantly lower in the 10,000 and 3,000 ppm group males compared to controls, but not in the 6,500 ppm group males. Isolated, greatly enlarged axons were noted in the medulla of one male in the 10,000 ppm group; no other histopathologic lesions were present in the brain that could be attributed to *n*-hexane exposure. Neuropathological studies on peripheral nerves revealed signs of axonopathy in the tibial nerve in 4 of 5 males from the 10,000 ppm and 1 of 5 males from the 6,500 ppm group. The lesions were at an early stage of development and consisted of paranodal axonal swelling in teased fibers from the nerve. The most extreme examples of these swellings were noted in the smaller branches of the sciatic nerve. No evidence of segmental demyelination or axonal degeneration was observed. No consistent changes were present in any female rats or in males from the 3,000 ppm group.

The dose-duration relationship for *n*-hexane neurotoxicity was examined in male Sprague-Dawley rats in another intermittent exposure to *n*-hexane at higher concentrations (0, 500, 1,500, 2,500, or 5,000 ppm) for 9-10 hours a day, 5 days a week for 7, 14, or 30 weeks. No clinical signs of neurotoxicity (gait disturbance, hindlimb weakness) were noted in any of the treated groups (Frontali et al.1981). Histopathological examination showed no effect on tibial nerve branches at 500 and 1,500 ppm for any duration up to 30 weeks. Pathological alterations (giant axonal degeneration) were seen in rats exposed to 2,500 ppm for 30 weeks or to 5,000 ppm for 14 weeks. Exposure at 5,000 ppm for 7 weeks was without effect.

The effect of *n*-hexane exposure on nerve conduction velocity was investigated in male Wistar rats exposed to *n*-hexane at 0, 500, 1,200, or 3,000 ppm 12 hours a day for 16 weeks (Huang et al.1989). From week 12, a marked decrease in grip strength and "slowness of action" were observed in the 3,000 ppm and 1,200 ppm exposed rats. However, by the end of exposure, no rat displayed definite quadriplegia or hindlimb paralysis. After week 8, motor nerve conduction velocity in the 3,000 ppm and 1,200 ppm treated

2. HEALTH EFFECTS

rats was significantly reduced. At week 16, inspection of graphical data indicated a control velocity of approximately 32 m/sec, 27 m/sec in the 1,200 ppm group (14% decrease) and 23 m/sec in the 3,000 ppm group (28% decrease). No significant decrease was seen at 500 ppm. Paranodal swellings and demyelination as well as remyelination of the peripheral nerve in the 3,000 ppm treated rats were observed. Similar changes were observed in the 1,200 ppm exposed rats but to a lesser degree. No abnormalities were found in the 500 ppm and the control rats.

In a study which compared the toxicity of several straight-chain alkanes, groups of male Wistar rats were exposed to target concentrations of 3,000 ppm *n*-pentane, *n*-hexane, or *n*-heptane 12 hours a day for 16 weeks (Takeuchi et al.1980). An unsteady and waddling gait was observed in 1 of 7 rats in the *n*-hexane group (actual concentration 3,040 ppm) after 10 weeks of exposure. After 12 weeks, 4 of 7 had an unsteady, waddling gait and 2 had foot-drop. The 2 rats with foot-drop died 1 and 3 days before the end of the 16-week-exposure period. The 5 surviving rats all showed unsteady waddling gait at the end of 16 weeks, and 2 had foot-drop. Motor nerve and mixed nerve conduction velocities were significantly decreased in the *n*-hexane group by 4 weeks and became progressively slower during the study. Distal latencies (time from onset of stimulus to recording of response at the distal nerve end) were increased. Histological examination showed that rats in the *n*-hexane group had paranodal swelling in myelinated nerves and accumulations of neurofilaments in the axoplasm. Many denervated neuromuscular junctions were also observed. None of these signs were seen in the *n*-pentane or *n*-heptane groups.

The effect of age on the rate of development and severity of effects of *n*-hexane exposure was studied in weanling (21 days old) and young adult (80 days old) male Fischer 344 rats exposed to 0 or 1,000 ppm for 24 hours a day, 6 days a week for 11 weeks (Howd et al.1983). Forelimb and hindlimb grip strength, and amplitude and conduction time of the compound action potential in the ventral caudal nerve of the tail were monitored weekly. Brainstem auditory-evoked responses were recorded beginning after 4 weeks of exposure. In general, effects had an earlier onset and were more severe in young adults than in weanlings. Mild signs (slight ataxia) were seen in the weanlings at 8 weeks (2 of 10), all weanlings had these signs by the end of exposure (11 weeks). More serious signs (difficulty walking, flaccid hindlimbs) were not observed in the weanlings. Weanlings recovered completely over the next 4 weeks. In contrast, slight ataxia was observed in young adults by 7 weeks (2 of 10), and all young adults were affected by 8 weeks. Difficulty in walking was observed in 3 of 10 young adults at 8 weeks; by the end of exposure at 11 weeks, all young adults had flaccid paralysis of the hindlimbs or had died (2 of 10). Only slight recovery took place over the next 4 weeks. Within 2 weeks of exposure, decreases in grip strength were apparent in rats

2. HEALTH EFFECTS

of both ages. Hindlimb grip strength was more severely decreased than forelimb grip strength by exposure to *n*-hexane, and the young adults were more severely affected than weanlings with respect to their age-matched controls during exposure and recovery. In both weanling and young adult exposed rats, motor nerve action potential latency (time from onset of stimulus to the motor nerve to recording of the action potential distally) began to increase at 7-8 weeks while the amplitude decreased. By the end of the exposure period, action potential amplitude had decreased so much that action potentials could not be detected in many of the exposed rats during the recovery period. There were no differences between weanling and young adult rats in their brainstem auditory-evoked responses when measured after 4 weeks of exposure. The latency of the first component of the brainstem auditory-evoked responses increased in *n*-hexane-exposed groups compared to controls. This effect was significant from week 7 through week 9 in weanlings and from week 7 through the last week of exposure in young adults. Complete recovery was seen in both age groups. The conduction time in the central auditory tracts between the first and fifth components of the brainstem auditory-evoked response was significantly prolonged in the *n*-hexane exposed rats (both ages) from the fourth week. This effect persisted throughout the exposure, after which there was some recovery. The most sensitive of the measures in revealing the onset of the developing neuropathy was hindlimb grip strength. The authors suggested that the relative resistance of the weanling rats to *n*-hexane neuropathy may be due to shorter, smaller-diameter axons, or to a greater rate of growth and repair in their peripheral nerves compared to those of adults.

Evoked responses in brain and peripheral nerve during and after *n*-hexane exposure were investigated in male Fischer 344 rats exposed to 0, 500, 1,000 or 1,500 ppm for 24 hours per day, 5 days per week, for 11 weeks and observed for a 6-week recovery period (Rebert and Sorenson 1983). Fore- and hindlimb grip strengths were significantly decreased at all concentrations by 4 weeks; recovery was concentration-dependent, being most rapid at 500 ppm and slowest at 1,500 ppm. Ventral caudal nerve action potential latency was unaffected at 500 ppm, but increased significantly in the 1,500 ppm group at 3 weeks. Latencies continued to increase during the recovery period in the 1,000 and 1,500 ppm groups. Somatosensory-evoked responses (recorded in the brain) were also unaffected in the 500 ppm group, but both latency and amplitude were affected in the 1,000 and 1,500 groups. Little recovery occurred in the affected groups. In contrast, effects on the brainstem auditory-evoked response and cortical auditory-evoked response did recover after exposure. The authors suggested that the differences in recovery may be accounted for by the greater prevalence of longer, larger-diameter fibers in the somatosensory system.

2. HEALTH EFFECTS

Mice appear to be less susceptible to *n*-hexane neurotoxicity than rats. In B6C3F₁ mice exposed to 0, 500, 1,000, 4,000, or 10,000 ppm *n*-hexane for 6 hours a day, 5 days a week for 13 weeks, the only neurobehavioral finding observed in exposed animals was a decrease in locomotor activity in female mice at 10,000 ppm (Dunnick et al. 1989; NTP 1991). Paranodal swellings were detected in 6 of 8 mice (3 of 4 females and 3 of 4 males) from the 10,000 ppm group. Incidences in the affected mice ranged from 1 of 59 to 10 of 88 axons examined. More serious signs (segmental demyelination, distal axonal degeneration, and axonal swelling in the spinal cord) were not observed in mice from any treatment groups. No treatment-related lesions were observed in the brain in any group. In mice exposed to 1,000 ppm *n*-hexane for 22 hours a day, 5 days a week for 13 weeks, neurobehavioral test results were similar between control and exposed groups. Paranodal swellings were detected in 6 of 8 mice (3 of 4 females and 3 of 4 males) from the exposed group, but not in the control group. Incidences in the affected mice ranged from 1 of 59 to 6 of 60 axons examined. No other lesions were observed in the peripheral or central nervous systems.

New Zealand rabbits exposed to 3,000 ppm *n*-hexane for 8 hours a day, 5 days a week for 24 weeks, showed no signs of peripheral neurotoxicity (hindlimb weakness, foot dragging) (Lungarella et al. 1984).

The effect of co-exposure to *n*-hexane and methyl isobutyl ketone was investigated in chickens (Abou-Donia et al. 1985). (While non-mammalian species are not commonly used in toxicology studies, the chicken has proven to be a valuable model for a human neurotoxicity caused by organophosphates which is clinically similar to that caused by *n*-hexane [Abou-Donia and Lapadula 1990]). During a continuous 90-day exposure, chickens exposed to 1,000 ppm *n*-hexane alone developed mild ataxia (1 on a scale of 5) while chickens exposed to 1,000 ppm methyl isobutyl ketone alone showed signs of leg weakness. Co-exposure to *n*-hexane and methyl isobutyl ketone caused severe neurologic deficits progressing to paralysis. Time to onset and severity correlated with methyl isobutyl ketone concentration. The spinal cord of one chicken exposed to 1,000 ppm *n*-hexane showed equivocal histologic changes in the lumbar region. Another hen exhibited unequivocal degeneration of the axons and myelin in the ventral columns of the thoracic spinal cord. No changes were seen in peripheral nerves. No histologic changes were seen in chickens exposed to 1,000 ppm methyl isobutyl ketone alone. Lesions in the nervous tissues of chickens exposed to mixtures of *n*-hexane and methyl isobutyl ketone were dependent on methyl isobutyl ketone concentration, period of exposure, and duration of intoxication. In another study examining the effect of *n*-hexane alone and in combination with other chemicals, a 30-day, 24-hour-a-day exposure to 1,008 ppm had no effect (Abou-Donia et al. 1991). However, concurrent exposure to *n*-hexane, methyl isobutyl ketone, and the organophosphate O-ethyl O-nitrophenyl phenylphosphonothioate (EPN) greatly increased

2. HEALTH EFFECTS

the neurotoxicity observed compared to chickens treated simultaneously with methyl isobutyl ketone and EPN.

The highest NOAEL values and all reliable LOAEL values for neurological effects in each species and duration category are recorded in Table 2-1 and plotted in Figure 2-1.

2.2.1.5 Reproductive Effects

No studies were located regarding reproductive effects in humans after inhalation exposure to *n*-hexane. Maternal toxicity (reduced weight gain in dams) was noted in pregnant rats exposed for 20 hours a day to 5,000 ppm *n*-hexane over gestation days 6-19 (Mast et al.1987). No effects were seen at 200 or 1,000 ppm in this study. No evidence of maternal toxicity was seen in pregnant rats exposed to 93 or 409 ppm *n*-hexane for 6 hours a day during gestation days 6-15 (Litton Bionetics 1979). There were no differences in body weight, and all animals were normal in appearance throughout the study.

Reproductive tissue lesions were observed in male Wistar rats exposed to 5,000 ppm *n*-hexane for various periods up to 6 weeks (De Martino et al.1987). The earliest lesions were observed (3 of 6 animals for testis, 4 of 6 for epididymis) after a single 24-hour treatment and involved focal degeneration of primary spermatocytes from the leptotene to the middle pachytene stages and cytoplasmic swelling of spermatids at late stages of maturation in the testis; at the same time, numerous, exfoliated, injured germ cells reached the epididymis. After the 24-hour treatment was suspended, damage to the seminiferous epithelium increased for the first 7 days, while the epididymis also showed focal infiltration by inflammatory cells. Recovery to normal occurred over days 14-30. Lesions were generally more severe in groups treated 16 hours a day for 2, 4, 6, or 8 consecutive days compared to the group treated continuously for 24 hours. After 8 days, massive exfoliation of apparently normal and degenerated spermatids and spermatocytes at various stages of differentiation was observed. Numerous spermatocytes at meiotic metaphase had undergone degeneration characterized by basophilic cytoplasm. Sertoli cells showed retraction of apical cytoplasm and vacuolization. The lumen of the epididymis contained degenerated spermatids and spermatocytes; amorphous coagulated material often lined the apical cytoplasm of the epithelium. Thickening and sclerosis of the arteriolar media were observed in the interstitium. Recovery was not followed in these groups of animals. Reproductive lesions were generally more severe as the duration of treatment increased. Treatment for 2-4 weeks resulted in nuclear vacuolated and/or multinucleated round spermatids and

2. HEALTH EFFECTS

spermatocytes, massive exfoliation and degeneration of spermatids and prophase spermatocytes, drastic increase of necrotic spermatocytes at metaphase, and a reduction in number of spermatogonia. Sertoli cells showed nuclear swelling and vacuolization. Numerous degenerated germ cells were found in the epididymal tubule. Five to six weeks of treatment induced a gradual reduction in diameter and collapse of the seminiferous tubules and, in some cases, development of tubules containing only Sertoli cells and rare spermatogonia (aplasia). Numerous lipid droplets were visible in the cytoplasm of Sertoli cells. Testicular damage continued to progress during the follow-up period after treatment ended. Most animals reached aplasia. Numerous inflammatory cells were visible in the interstitium and inside the epithelium of the caput epididymis.

In contrast, acute-duration exposure to up to 5,000 ppm *n*-hexane for 20 hours a day for 5 consecutive days caused no changes in mouse sperm morphology when sperm were examined 5 weeks later (Mast et al. 1989a). Similar exposure also had no effect on the fertility of male mice over the following 8 weeks (Mast et al. 1989b).

Intermediate-duration inhalation exposure to *n*-hexane has also caused reproductive effects in animals. Male reproductive tissues were examined in Sprague-Dawley rats after 28 or 61 days of daily exposure to 1,000 ppm *n*-hexane for 18-21 hours a day (Nylen et al. 1989). Following *n*-hexane exposure, 4 of 6 rats had bilateral testicular damage and a reduced body weight 2 weeks after exposure, and 3 of 6 rats had bilateral testicular damage and reduced body weight 10 months post-exposure. The extent of body weight loss was not reported. Testes of affected rats were markedly reduced in size and weight. The muscles of the hind limbs in all rats with testicular damage were severely atrophic. Atrophic changes of seminiferous tubules throughout the testes were found 2 weeks, 10, 12, and 14 months after cessation of exposure. The testicular tissue of the macroscopically affected *n*-hexane-treated rats was severely disturbed, with total absence of a nerve growth factor-immunoreactive cell population. Total loss of the germ cell line was found in a fraction of animals up to 14 months postexposure, indicating permanent testicular damage. No impairment of androgen synthesis or androgen dependent accessory organs was observed. In a study where the responses to *n*-hexane exposure of weanling (21 days old) and young adult Fischer 344 rats (80 days old) were compared, both absolute and relative testes weights were significantly lower in *n*-hexane-exposed rats compared to controls (Howd et al. 1983). In this study, exposure was 24 hours a day for 11 weeks to up to 1,500 ppm *n*-hexane. No differences were noted between the two age groups.

2. HEALTH EFFECTS

In contrast, no reproductive effects were observed in male Sprague-Dawley rats exposed to 500 ppm *n*-hexane 22 hours a day for 6 months (IRDC 1981). No treatment-related lesions were noted in any of the reproductive tissues examined (seminal vesicles, prostate, testis, epididymis). Similar results were reported in both sexes of weanling Fischer 344 rats exposed to up to 10,000 ppm *n*-hexane 6 hours a day, 5 days a week for 13 weeks (Cavender et al.1984). No treatment-related histopathologic lesions were present in any of the following reproductive tissues: ovaries, uterus, oviducts, vagina, cervix, seminal vesicles, prostate, testis, or epididymis.

Male mice do not appear to be sensitive to *n*-hexane-induced reproductive effects after intermediateduration exposure to *n*-hexane. The fertility of male CD-1 mice was unaffected by exposure to 99 or 396 ppm *n*-hexane for 6 hours a day, 5 days a week for 8 weeks (Litton Bionetics 1980). Fertility indices of females were similar between those mated to control and treated rats for 2 weeks following exposure.

Histopathological examination of B6C3F₁ mice exposed to *n*-hexane at concentrations up to 10,000 ppm for 6 hours a day, 5 days a week for 13 weeks or 1,000 ppm for 22 hours a day, 5 days a week for 13 weeks (Dunnick et al.1989; NTP 1991) revealed no treatment-related lesions in any of the reproductive tissues examined (seminal vesicles, prostate, testis, epididymis, ovary, uterus).

No chronic-duration exposure inhalation studies in animals were located for *n*-hexane.

The highest NOAEL values and all reliable LOAEL values for reproductive effects in each species and duration category are recorded in Table 2-1 and plotted in Figure 2-1.

2.2.1.6 Developmental Effects

In a developmental study using 30 pregnant Sprague-Dawley rats exposed for 20 hours a day to 0, 200, 1,000, or 5,000 ppm over gestation days 6-19, *n*-hexane had no effect on the number of implantations, the mean percentage of live pups per litter, the mean percentage of resorptions per litter, or on the fetal sex ratio compared to controls (Mast et al.1987). There were no maternal deaths and no clinical signs of toxicity were noted. No significant differences were observed in intrauterine death rate, or in fetal body weight, or in the incidence of fetal malformations. A statistically significant reduction in fetal body weight relative to controls was observed for males at the 1,000 and 5,000 ppm exposure levels (7 and 15%), respectively, but there was maternal toxicity (reduced weight gain) in dams at 5,000 ppm. In pregnant

2. HEALTH EFFECTS

female Wistar rats exposed to 500 ppm *n*-hexane for 23 hours a day throughout gestation (21 days), reduced body weight of offspring was reported ranging from 22% at postnatal day 9 to 13% at postnatal day 25 (Stoltenburg-Didinger et al. 1990). Delayed histogenesis of the cerebellar cortex in the offspring of exposed dams was also reported during the first 30 postnatal days. The number of offspring examined in this study was not reported and statistical analysis of body weights was not performed.

In a study on the effect of *n*-hexane exposure at various times during gestation, no significant adverse developmental effects were found (Bus et al. 1979). Pregnant Fischer 344 rats (7 control and 7 treated) were exposed to 1,000 ppm *n*-hexane for 6 hours per day during gestation days 8-12, 12-16, or 8-16. No significant alterations in fetal resorptions, body weights, visible anomalies, or the incidence of soft tissue and skeletal anomalies were noted in any of the treatment groups. A temporary decrease in pup weight gain was seen in the offspring from dams exposed during gestation days 8-16. A low incidence of pyelectasis (enlarged renal pelvis) was noted in each of the three treatment groups; however, this was only observed when the litters contained fewer than three fetuses. A low, nonsignificant incidence of misaligned fourth sternbrae was noted in each of the treatment groups. The number of fetuses examined per group ranged from 18 to 36.

Similar results were observed in pregnant rats exposed to 93 or 409 ppm for 6 hours a day during gestation days 6-15 where larger groups of fetuses per treatment group (150-188) were examined (Litton Bionetics 1979). There were no compound related deaths and all dams were normal in appearance throughout the study. Enlarged salivary glands were noted at necropsy in one control and two animals from each treated group but were judged not to be treatment-related. Mean body weight and food consumption were not affected by treatment. Live litters, implantation sites, resorptions, mean litter size, and average fetal weight were not affected by treatment. No soft-tissue abnormalities were observed. There was no statistically significant difference in skeletal abnormalities between control and treated groups.

Concentration-related developmental effects were observed in groups of 35 pregnant Swiss mice exposed to *n*-hexane for 20 hours a day during gestation days 6-17 at 0, 200, 100, and 5,000 ppm (Mast et al. 1988). Maternal body weight was significantly reduced (6%) at 5,000 ppm, but this was accompanied by a decrease in mean gravid uterine weight. There was no effect on body weight in a group of 10 non-pregnant mice co-exposed to *n*-hexane at 5,000 ppm in this experiment. The mean ratio of uterine weight to extra-gestational weight gain for all treatment groups was less than for the control groups, this difference was statistically significant for the 5,000 ppm group. The number of live fetuses per litter was significantly

2. HEALTH EFFECTS

reduced at 5,000 ppm, with a significant concentration dependent trend. The number of resorptions per litter was significantly increased at 200 ppm, but not at higher concentrations. Fetal weights (male and female combined) were slightly, but not significantly, reduced for all treatment groups compared to controls. However, the decrease was significantly correlated to increasing *n*-hexane concentration. Male fetal weights for *n*-hexane exposure groups were not significantly affected compared to controls, but female fetal weights were significantly reduced for the 5,000 ppm group compared to controls. There was no increased incidence of malformations or variations in any group exposed to *n*-hexane.

Exposure to much higher concentrations of *n*-hexane as a component of a commercial hexane mixture (53.45%) did not cause developmental effects in Sprague-Dawley rats (Neeper-Bradley 1989a). Groups of pregnant Sprague-Dawley rats (n=25/group) were exposed to commercial hexane vapor for 6 hours/day on gestational days 6-15. Exposure concentrations were 0, 914, 3,026, and 9,017 ppm. No significant differences between groups were observed for the number of viable implantations per litter, number of nonviable implantations per litter, sex ratio, fetal body weights (total, male and female), incidence of individual or pooled external, visceral or skeletal malformations or total malformations, the incidence of variations by category, or of total variations. Some maternal toxicity occurred during the exposure period as reflected by reduced weight gain, but total weight gain throughout pregnancy was unaffected by exposure. The authors concluded that exposure to commercial hexane vapor by inhalation during organogenesis in Sprague-Dawley rats resulted in maternal toxicity at 3,026 and 9,017 ppm, with no apparent developmental toxicity at any level.

In a parallel experiment in CD-1 mice (Neeper-Bradley 1989b) under the same exposure conditions (30 dams/group), no significant differences between groups were observed for the number of viable implantations per litter, number of nonviable implantations per litter, sex ratio, or fetal body weights (total, male and female). Slight maternal toxicity (color changes in the lungs at necropsy) was observed at 3,026 and 9,017 ppm. A significantly increased incidence of poor ossification occurred at 2 of the 84 sites examined (bilateral bone island at the first lumbar arch and all intermediate phalanges of the hindlimb unossified) in the 9,017 ppm group. There were no significant differences among groups for the incidences of variations by category (external, visceral, or skeletal) or by total variations. The authors concluded that exposure to commercial hexane vapor by inhalation during organogenesis in the CD-1 mouse resulted in slight maternal toxicity at 3,026 and 9,017 ppm and slight developmental toxicity (in the absence of malformations) at 9,017 ppm.

2. HEALTH EFFECTS

The highest NOAEL values for developmental effects in each species and duration category are recorded in Table 2-1 and plotted in Figure 2-1.

2.2.1.7 Genotoxic Effects

Structural abnormalities in sperm were observed in Sprague-Dawley rats after exposure to 5,000 ppm *n*-hexane for 16 hours a day for 2-8 days (De Martino et al.1987). Multinucleated round spermatids and spermatocytes were observed.

In contrast, sperm abnormalities were not observed in B6C3F₁ mice exposed to up to 5,000 ppm *n*-hexane for 5 days for 20 hours a day (Mast et al.1989a). Analysis of sperm obtained 5 weeks post-exposure showed no significant effects on morphology compared to the control group, while a significant doserelated reduction in the percentage of normal sperm was seen with the positive control agent, ethyl methanesulfonate.

In a dominant lethal assay in male CD-1 mice, *n*-hexane exposure at 99 or 396 ppm for 6 hours a day, 5 days a week for 8 weeks did not cause dominant lethal mutations (Litton Bionetics 1980). (The dominant lethal assay is designed to determine the ability of a test compound to induce genetic damage in the germ cells of treated male mice that could lead to death or developmental failure of zygotes heterozygous for such a lesion). The average number of implantations per pregnant female was not affected by *n*-hexane exposure, while it was significantly reduced in the positive control. The average resorptions or dead implants were not significantly increased by *n*-hexane exposure but were increased by the positive control. A further comparison between the proportions of females with one or more dead implants also showed no adverse effect from *n*-hexane exposure. Similar results were observed in another dominant lethal mutation study at higher concentrations in which male Swiss mice were exposed to up to 5,000 ppm *n*-hexane for 20 hours a day for 5 days (Mast et al.1989b).

There was no increase in the incidence of micronucleated normochromatic erythrocytes or polychromatic erythrocytes in the peripheral blood of male and female mice exposed to 1,000, 4,000, or 10,000 ppm *n*-hexane, 6 hours a day, 5 days a week for 13 weeks or in mice exposed to 1,000 ppm for 22 hours a day for 13 weeks (NTP 1991). Other genotoxicity studies are discussed in Section 2.5.

2. HEALTH EFFECTS

2.2.1.8 Cancer

Papillary tumors, apparently derived from Clara cells, in the bronchiolar epithelium have been reported in a group of 12 New Zealand rabbits exposed to 3,000 ppm *n*-hexane for 8 hours a day, 5 days a week for 24 weeks (Lungarella et al.1984), but the incidence was not reported.

In a chronic-duration study in B6C3F₁ mice (50/sex/group) where exposure to commercial hexane (51.5% *n*-hexane) was for 6 hours/day, 5 days a week for 2 years, a statistically significant treatment-related increase in hepatocellular neoplasms (adenoma and carcinoma) was observed among females exposed at 9,018 ppm (Bio/Dynamics 1995b). Incidences of adenoma were: 4/50, 6/50,4/50, and 10/50 at 0, 900, 3,000, and 9,018 ppm, respectively. Incidences of carcinoma at these exposures were 3/50, 2/50, 5/50, and 6/50 and total neoplasms 7/50, 8/50, 9/50, and 16/50. In males, liver neoplasms were observed but were not treatment-related (total neoplasms 17/49, 16/50, 17/50, 13/50, respectively). There was no treatment-related increase in any other lesions of the liver, including foci of cellular alteration among males and females. In 9,018 ppm group females, liver tumor incidence was similar to control males. A significant treatment-related decrease in severity of cystic endometrial hyperplasia of the uterus was also observed among 9,018 ppm group females. The authors suggested that the decrease in severity of cystic endometrial hyperplasia may indicate a possible treatment-related alteration in the hormonal balance (e.g., a decrease in estrogenic stimulation of the uterus), resulting in the female mice showing the normal incidence of male liver neoplasms. It is unclear what components of the hexane mixture caused the neoplasms.

No increased incidence of neoplasms at any site was observed in Fischer 344 rats of either sex (50/sex/group) similarly exposed to commercial hexane in a parallel experiment (Bio/Dynamics 1995a). The Cancer Effect Level (CEL) for rabbits after intermediate-exposure is recorded in Table 2-1 and plotted in Figure 2-1.

2.2.2 Oral Exposure

2.2.2.1 Death

In an LD₅₀ (lethal dose, 50% kill) test with Sprague-Dawley rats (sex not specified), an LD₅₀ of 15,840 mg/kg was reported for 14-day-old rats (Kimura et al.1971). Values of 32,340 and 28,710 mg/kg

2. HEALTH EFFECTS

were reported for young (80-160 g) and older (300-470 g) adults, respectively. An LD₅₀ for newborns could not be derived because of dose-volume limitations.

In a gavage study where rats were administered 570, 1,140, or 4,000 mg/kg/day *n*-hexane for 90-120 days, 3 rats died due to gavage error (chemical pneumonitis immediately following dosing), but no other deaths were reported (Krasavage et al.1980).

As part of a developmental study on oral exposure to *n*-hexane, pregnant 60-90-day-old outbred albino mice (CD-1) received *n*-hexane (99%) once daily at doses up to 2,200 mg/kg/day on gestation days 6-15 by cottonseed oil gavage. One of 14 mice died after receiving 10 daily doses of 2,200 mg/kg/day (Marks et al.1980). In a second study where doses were given 3 times a day, 2 of 25 died at 2,830 mg/kg/day, 3 of 34 at 7,920 mg/kg/day, and 5 of 33 at 9,900 mg/kg/day (Marks et al.1980).]

No deaths occurred in chickens receiving 100 mg/kg/day *n*-hexane for 90 consecutive days (Abou-Donia et al.1982).

The LOAEL values and LD₅₀ from each reliable study for death in each species and duration category are recorded in Table 2-2 and plotted in Figure 2-2.

2.2.2.2 Systemic Effects

No studies were located regarding systemic effects after oral exposure to *n*-hexane in humans. The only studies regarding systemic effects in animals after oral exposure to *n*-hexane reported body weight effects in rats and chickens.

The highest NOAEL values and all LOAEL values from each reliable study for body weight in rats and chickens during acute- and intermediate-duration exposures are recorded in Table 2-2 and plotted in Figure 2-2.

Body Weight Effects. An unspecified but statistically significant decrease in body weight was observed in male Sprague-Dawley rats receiving 5 consecutive daily doses of 10,000 mg/kg/day *n*-hexane (Linder et al.1992). Body weight had returned to normal 13 days after treatment. A body weight decrease of approximately 10% was seen in COBS rats exposed by gavage to 1,140 mg/kg/day *n*-hexane for

Table 2-2. Levels of Significant Exposure to n-Hexane - Oral

Key to figure ^a	Species (Strain)	Exposure/duration/frequency (Specific route)	System	LOAEL		Reference
				NOAEL (mg/kg/day)	Less serious (mg/kg/day)	
ACUTE EXPOSURE						
Death						
1	Rat (Sprague-Dawley)	once (G)				15840 (LD ₅₀) Kimura et al. 1971
2	Mouse (CD-1)	10 d Gd 6-15 1 x/d (GO)				2200 F (1/14 died) Marks et al. 1980
3	Mouse (CD-1)	10 d Gd 6-15 3 x/d (GO)				2830 F (2/25 died) Marks et al. 1980
Systemic						
4	Chicken (Leghorn)	once or twice Day 0, 21 1 x/d (G)	Bd Wt	2000 F		Abou-Donia et al. 1982
Neurological						
5	Chicken (Leghorn)	once or twice Day 0, 21 1 x/d		1000 F	2000 F (mild leg weakness)	Abou-Donia et al. 1982
Reproductive						
6	Rat (Sprague-Dawley)	1 d 2x (G)			20000M (transient decreased sperm head count per gram testis)	Linder et al. 1992

Table 2-2. Levels of Significant Exposure to n-Hexane - Oral (continued)

Key to figure ^a	Species (Strain)	Exposure/duration/frequency (Specific route)	System	LOAEL		Reference
				NOAEL (mg/kg/day)	Less serious (mg/kg/day)	
Developmental						
7	Mouse (CD-1)	10 d Gd 6-15 1 x/d (GO)		2200		Marks et al. 1980
8	Mouse (CD-1)	10 d Gd 6-15 3 x/d (GO)		2830	7920 (reduced fetal weight)	Marks et al. 1980
INTERMEDIATE EXPOSURE						
Systemic						
9	Rat (COBS)	90-120 d 5 d/wk 1 x/d (G)	Bd Wt	570 M	1140M (10% decrease)	Krasavage et al. 1980
10	Rat (Wistar)	8 wk 7 d/wk 1 x/d (GO)	Bd Wt	1251 M		Ono et al. 1981
11	Chicken (Leghorn)	90 d 1 x/d (G)	Bd Wt		100 F (19% decrease)	Abou-Donia et al. 1982
Neurological						
12	Rat (COBS)	90-120 d 5 d/wk 1 x/d (G)		1140 M	4000 M (severe hindlimb paralysis, axonal swelling, myelin retraction)	Krasavage et al. 1980

Table 2-2. Levels of Significant Exposure to n-Hexane - Oral (continued)

Key to figure ^a	Species (Strain)	Exposure/ duration/ frequency (Specific route)	System	NOAEL (mg/kg/day)	LOAEL		Reference
					Less serious (mg/kg/day)	Serious (mg/kg/day)	
13	Rat (Wistar)	8 wk 7 d/wk 1 x/d (GO)			1251 M (decreased motor and mixed nerve conduction velocity)		Ono et al. 1981
14	Chicken (Leghorn)	90 d 1 x/d (G)			100 F (leg weakness)		Abou-Donia et al. 1982
Reproductive							
15	Rat (COBS)	90-120 d 5 d/wk 1 x/d (G)		1140 M		4000 M (atrophy of testicular germinal epithelium)	Krasavage et al. 1980

^aThe number corresponds to entries in Figure 2-2.

Bd Wt = body weight; d = day(s); F = female; Gd = gestational day; (G) = gavage; (GO) = gavage in oil; LD₅₀ = lethal dose, 50% kill; LOAEL = lowest-observed-adverse-effect level; M = male; NOAEL = no-observed-adverse-effect level; wk = week(s); x = times

Figure 2-2. Levels of Significant Exposure to *n*-Hexane - Oral
Acute (≤14 days)

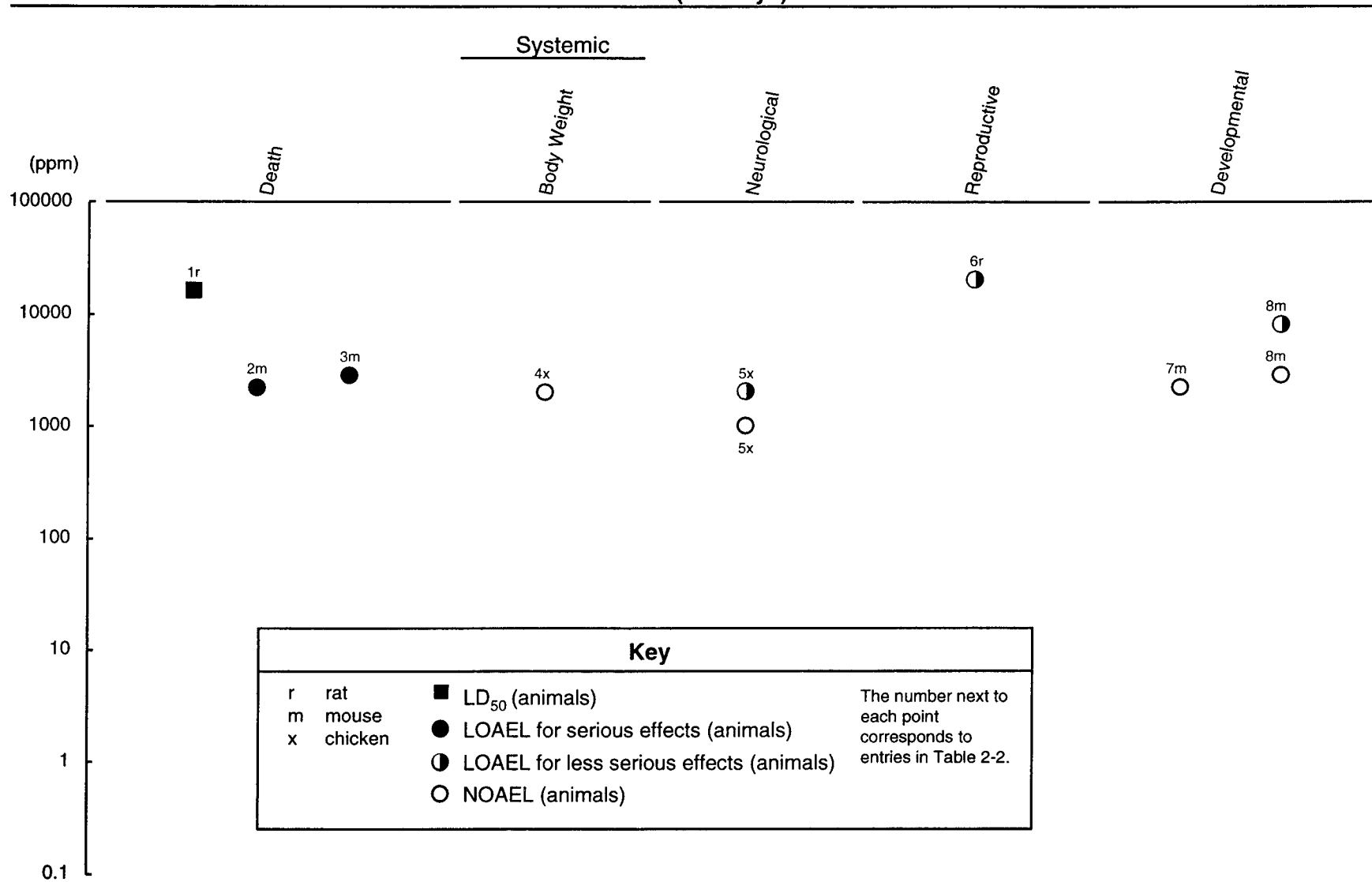
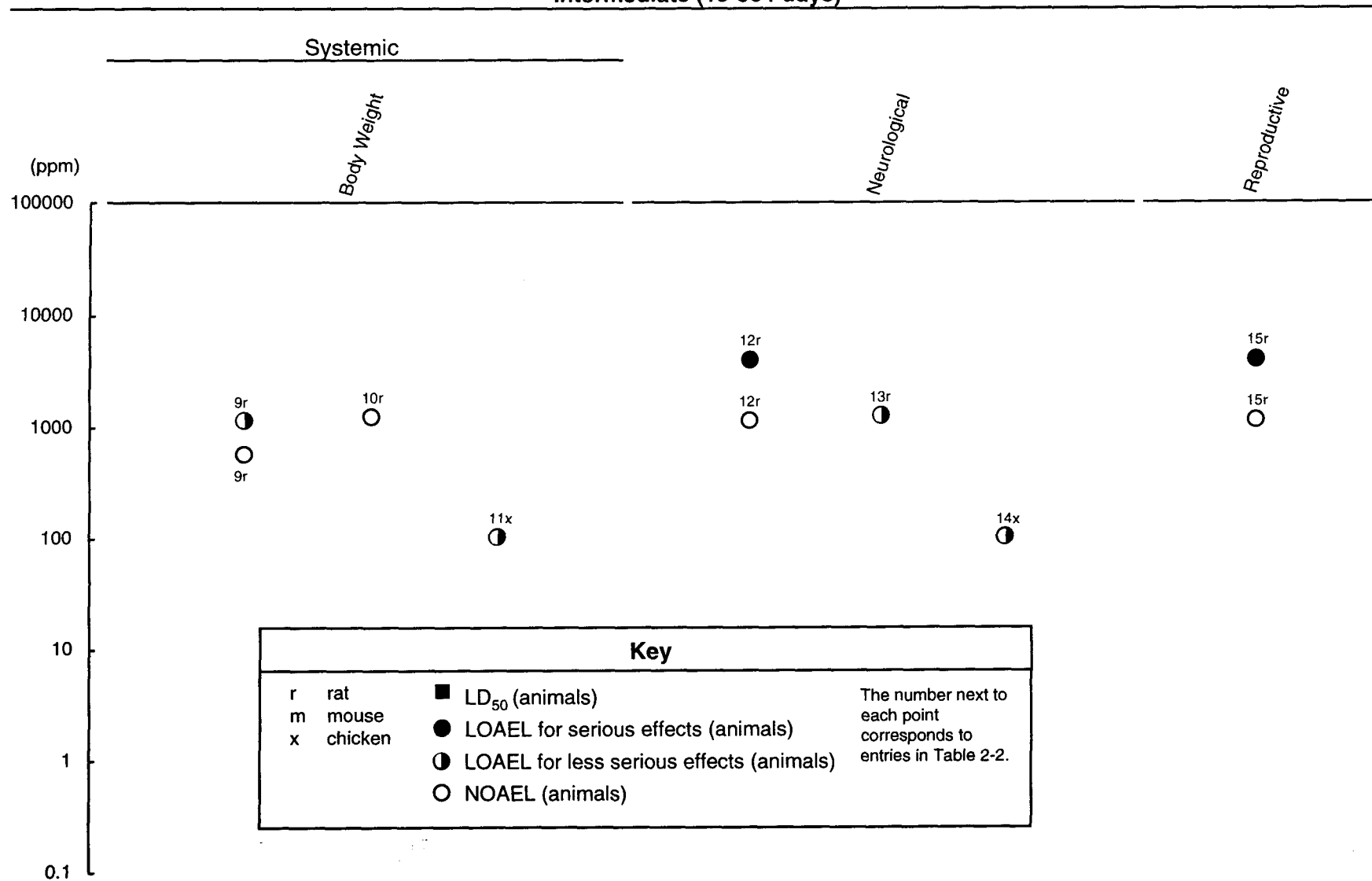

Figure 2-2. Levels of Significant Exposure to *n*-Hexane - Oral (cont.)
Intermediate (15-364 days)



2. HEALTH EFFECTS

90 days (Krasavage et al.1980). Decreased body weight was observed at 570 mg/kg/day in this study (approximately 14%), along with a decrease in food consumption. Daily doses of 1,251 mg/kg/day of *n*-hexane had no effect on body weight in male Wistar rats over an 8-week period (Ono et al.1981). Two doses of up to 2,000 mg/kg/day given to chickens 21 days apart had no effect on body weight (Abou-Donia et al.1982). However, 100 mg/kg/day for 90 days caused a 19% decrease in body weight in this species.

2.2.2.3 Immunological and Lymphoreticular Effects

No studies were located regarding immunological/lymphoreticular effects after oral exposure to *n*-hexane in humans or animals.

2.2.2.4 Neurological Effects

Decreases in motor nerve conduction velocities were noted in rats after oral exposure to *n*-hexane (Ono et al.1981). In Wistar rats receiving an average daily dose of 1,251 mg/kg/day, the motor nerve conduction velocity in the *n*-hexane-treated group was significantly less than control after 4 and 8 weeks of administration. After 8 weeks of treatment with similar doses of the *n*-hexane isomer methylcyclopentane, the motor nerve conduction velocity was also decreased. No changes were observed with 2-methylpentane or 3-methylpentane. The distal mixed nerve conduction velocity in the *n*-hexane group was less than control after 4 weeks of administration; however, a significant difference with the other solvents was not observed. The proximal mixed nerve conduction velocity in the *n*-hexane group was less than control after 6 weeks of administration and after 8 weeks with 2-methylpentane and methylcyclopentane. No changes in behavior or clinical signs of peripheral neurotoxicity were noted. The authors speculated that the conduction velocity decreases observed with 2-methylpentane and methylcyclopentane may be the result of metabolism to the neurotoxic metabolite of *n*-hexane, 2,5-hexanedione (see Section 2.4).

In a study comparing oral administration of *n*-hexane with its metabolites, groups of 5 male COBS rats were exposed by gavage 5 days a week for 90-120 days with *n*-hexane, 2-hexanol, 2-hexanone, 2,5-hexanedione, 2,5-hexanediol, or 5-hydroxy-2-hexanone (Krasavage et al.1980). Practical grade hexane (40% *n*-hexane, 24% each 3-methylpentane and dimethylbutane, 9% cyclopentane, 2.5% cyclohexane, and 1.2% 2-methylpentane) was also tested. Test compounds were given as equimolar doses of 6.6 mmol/kg. *n*-Hexane was also given at 13.2 mmol/kg and 46.2 mmol/kg (up to 120 days); doses were 570, 1,140, or 4,000 mg/kg/day *n*-hexane. Practical grade hexane was also tested at 4,000 mg/kg/day.

2. HEALTH EFFECTS

Clinical signs of neurotoxicity (severe hindlimb weakness or paralysis) did not occur over the 90-day dosing period at 570 or 1,140 mg/kg/day *n*-hexane. However, at 4,000 mg/kg/day, these signs were present after 101 days in 3 of 4 rats. Clinical signs of neurotoxicity were seen with all the other chemicals tested except practical grade hexane. Time to onset was as little as 16.8 days with 2,5-hexanedione. No histologic evidence of tibial nerve alterations (multifocal axonal swellings, adaxonal myelin infolding, paranodal myelin retraction) was observed with *n*-hexane at 570 or 1,140 mg/kg/day, but was observed at 4,000 mg/kg/day. One rat of 5 treated with 4,000 mg/kg/day practical grade hexane showed histological lesions; none showed clinical signs of neurotoxicity.

Leghorn chickens (12 months old, 1.7 kg) were given oral doses of *n*-hexane and observed for clinical signs of neurotoxicity (Abou-Donia et al.1982). (While non-mammalian species are not commonly used in toxicology studies, the chicken has proven to be a valuable model for a human neurotoxicity caused by organophosphates which is clinically similar to that caused by *n*-hexane [Abou-Donia and Lapadula 19901.]) One chicken was given a single dose of 1,000 mg/kg, and 3 chickens were given 2,000 mg/kg, one dose at day 0 of the experiment and another at day 21. The 2,000 mg/kg dose caused mild leg weakness followed by full recovery after 2-4 days; no effect was seen at 1,000 mg/kg. Oral administration of the *n*-hexane metabolites 2,5-hexanedione, 2-hexanone, or 2,5-hexanediol caused ataxia leading to paralysis in this study. In a 90-day oral exposure at 100 mg/kg/day, leg weakness was observed, but no serious signs of neurotoxicity (Abou-Donia et al.1982).

The highest NOAEL values and all LOAEL values from each reliable study for neurological effects in each species and duration category are recorded in Table 2-2 and plotted in Figure 2-2.

2.2.2.5 Reproductive Effects

n-Hexane was 1 of 14 compounds used to evaluate multiple end points of spermatotoxicity in shortduration tests (Linder et al.1992). Three days after treatment ended, body weight and prostate weight were significantly decreased (amount unspecified) in rats receiving 10,000 mg/kg/day *n*-hexane for 5 consecutive days. No changes were noted 13 days post-treatment, or in rats receiving 20,000 mg/kg on a single day. No changes in male reproductive tissue histology were noted in 20,000 mg/kg *n*-hexane-treated rats, nor were there any changes in sperm motility or morphology after either 1-day exposure or 5-consecutive-day exposure. A significant decrease was noted in total sperm head counts per gram of testis 2 days after 1-day treatment (20,000 mg/kg), but not at 14 days. Total sperm head count, and specific counts in the caput and cauda region of the epididymis were unchanged after either 1-day exposure at 20,000 mg/kg (2 and 14 days after exposure) or 5-consecutive-day exposure at 10,000 mg/kg/day (3 and 13 days after the last exposure).

2. HEALTH EFFECTS

Changes in all these parameters were noted in rats receiving known reproductive toxicants such as benomyl and boric acid. In the group receiving a single 2,000 mg/kg dose of the *n*-hexane metabolite 2,5-hexanedione, no histopathological changes were detected 2 days after treatment; but at 14 days, testicular debris was observed in the proximal caput, sloughed epididymal cells were observed in the cauda lumen as was retention in the lumen of Step 19 (mature) spermatids in Stage IX-XII tubules. In a study where rats received 0, 570, 1,140, or 4,000 mg/kg/day *n*-hexane for 90-120 days (Krasavage et al.1980), varying stages of atrophy of testicular germinal epithelium were noted at 4,000 mg/kg/day but not at the lower doses.

In a developmental study in mice orally exposed to *n*-hexane, signs of maternal toxicity (1 of 14 died, reduced body weight gain) were observed at 2,200 mg/kg/day (Marks et al.1980). Maternal toxicity was also observed at higher doses: 2 of 25 dams at 2,830 mg/kg/day, 3 of 34 at 7,920 mg/kg/day, and 5 of 33 at 9,900 mg/kg/day died.

The highest NOAEL values and all LOAEL values from each reliable study for reproductive effects in each species and duration category are recorded in Table 2-2 and plotted in Figure 2-2.

2.2.2.6 Developmental Effects

In a developmental study, pregnant 60-90-day-old outbred albino mice (CD-1) received *n*-hexane (99%) once daily by cottonseed oil gavage at doses up to 2,200 mg/kg/day on gestation days 6-15 (Marks et. Al.1980). No statistically significant differences were observed between treated and control litter for total number of implants, numbr of resorptions, fetal deaths, sex ratio, number of stunted fetuses, live fetuses per dam, or fetal weight. No differences in the incidence in the incidence of malformed fetuses (visceral or skeletal) were observed. Signs of maternal toxicity (1 of 14 died reduced body weight gain) were observed. Signs of maternal toxicity (1 of 14 died, reduced body weight gain) were observed at 2,200 mg/kg/day. In a second study at higher does, pregnant mice received *n*-hexane (99%) 3 times daily by cottonseed oil gavage at doses up to 9,900 mg/kg/day on gestation days 6-15 (Marks et al.1980). The higher hexane doses were toxic: 2 of 25 dams at 2,830 mg/kg/day, 3 of 34 at 7,920 mg/kg/day, and 5 of 33 at 9,900 mg/kg/day died. At the 7,920 and 9,900 mg/kg/day doses, the average fetal weight was significantly reduced, but the incidence of malformations in treated- and vehicle-control groups did not differ significantly. *n*-Hexane was not teratogenic even at doses toxic to the dam.

The highest NOAEL values and the LOAEL value from the two reliable studies for developmental effects in mice for an acute duration are recorded in Table 2-2 and plotted in Figure 2-2.

2. HEALTH EFFECTS

2.2.2.7 Genotoxic Effects

No studies were located regarding genotoxic effects after oral exposure to *n*-hexane in human or animals.

Other genotoxicity studies are discussed in Section 2.5.

2.2.2.8 Cancer

No studies were located regarding cancer effects after oral exposure to *n*-hexane in humans or animals.

2.2.3 Dermal Exposure

2.2.3.1 Death

Topical application of a single 2 mL dose of undiluted *n*-hexane had no effect on survival or body weight in exposed guinea pigs observed for 35 days after exposure (Wahlberg and Boman 1979). Deaths and/or effects on body weight were seen with similar doses of other common industrial solvents tested in this study (carbon tetrachloride, dimethylformamide, ethylene glycol monobutylether, 1,1,1-trichloroethane, and trichlorethylene).

2.2.3.2 Systemic Effects.

The only reports regarding systemic effects in humans after dermal exposure to *n*-hexane are two studies describing dermal effects and ocular effects in volunteers. Ocular effects in rabbits and body weight effects in guinea pigs have also been reported.

The highest NOAEL values and all LOAEL values from each reliable study for systemic effects in each species and duration category are recorded in Table 2-3.

Dermal Effects. *n*-Hexane was 1 of 11 solvents tested for dermal toxicity in a male volunteer (Wahlberg 1984). Analytical grade *n*-hexane (1.5 mL; test area, 3.1 cm²) within a glass ring was applied to the volar forearm of the volunteer and left on the skin for 5 minutes. Blood flow values (expressed as a relative, dimensionless value) after dermal application of 1.5 mL of neat *n*-hexane appeared to increase

Table 2-3. Levels of Significant Exposure to n-Hexane - Dermal

Species (Strain)	Exposure/ Duration/ Frequency	System	NOAEL	LOAEL		Reference
				Less serious	Serious	
ACUTE EXPOSURE						
Systemic						
Human	once	Dermal	0.1 mL M	1.5 mL M (increased blood flow, slight and transient erythema, stinging and/or burning sensation)		Wahlberg 1984
Gn Pig (NS)	once	Bd Wt	2.0 mL			Wahlberg and Boman 1979
Rabbit (New Zealand)	1 wk 5 d/wk 8 hr/d	Ocular		3000 M (lacrimation, hyperemia of conjunctiva)		Lungarella et al. 1984
INTERMEDIATE EXPOSURE						
Systemic						
Rabbit (New Zealand)	24 wk 5 d/wk 8 hr/d	Ocular		3000 M (lacrimation, hyperemia of conjunctiva)		Lungarella et al. 1984

Bd Wt = body weight; d = day(s); Gn Pig = guinea pig; hr = hour(s); LOAEL = lowest-observed-adverse-effect level; M = male; NOAEL = no-observed-adverse-effect level; NS = not specified; wk = week(s)

2. HEALTH EFFECTS

about 6-fold at 15 minutes post-application. Blood flow had returned to control approximately 60 minutes after application. Unlike the other solvents tested (DMSO, trichlorethylene, toluene, 1,1,2-trichloroethane), blood flow increased for about 10 minutes after the end of the application. With the other solvents, blood flow either fell or remained unchanged after application. A slight transient erythema was observed after 10-20 minutes exposure to *n*-hexane and a stinging and/or burning sensation reported by the volunteer. Application of 0.1mL neat *n*-hexane did not cause clinical signs or affect blood flow.

Ocular Effects. Hexane was one of 16 industrial solvents (hydrocarbons, alcohols, ketones, esters, and ethyl ether) tested for irritation potential on an average of 10 volunteers of mixed sexes for 3-5 minutes in an inhalation chamber (Nelson et al.1943). The purity and the isomer composition of the hexane were not specified. Hexane was the only one of the 16 solvents which caused no irritation to the eyes, nose, or throat at the highest concentration tested (500 ppm).

Clinical signs of ocular irritation (lacrimation, hyperemia of the conjunctiva) were observed throughout a 24-week study in rabbits exposed to 3,000 ppm *n*-hexane (Lungarella et al.1984). These effects were the result of direct contact of *n*-hexane vapor with the eye.

Body Weight Effects. Topical application of a single 2 mL dose of undiluted *n*-hexane had no effect on body weight in exposed guinea pigs followed for 35 days after exposure (Wahlberg and Boman 1979). Effects on body weight were seen with similar doses of other common industrial solvents tested in this study (carbon tetrachloride, dimethylformamide, ethylene glycol monobutylether, 1,1,1-trichloroethane, and trichlorethylene).

No studies were located regarding the following health effects in humans or animals after dermal *exposure* to *n*-hexane:

2.2.3.3 Immunological and Lymphoreticular Effects

2.2.3.4 Neurological Effects

2.2.3.5 Reproductive Effects

2.2.3.6 Developmental Effects

2.2.3.7 Genotoxic Effects

Other genotoxicity studies are discussed in Section 2.5.

2. HEALTH EFFECTS

2.2.3.8 Cancer

No studies were located regarding cancer effects after dermal exposure to *n*-hexane in humans or animals.

2.3 TOXICOKINETICS

Exposure to *n*-hexane takes place predominantly by the inhalation route. This is due to rapid volatilization of liquid *n*-hexane (vapor pressure of 150 mm Hg at 25 °C). *n*-Hexane also has a very low solubility in water (9.5 mg/L at 25 °C), and significant oral exposure through food or drinking water has not been reported. Little toxicokinetic information exists for oral or dermal exposure to *n*-hexane in humans or animals. Inhaled *n*-hexane is readily absorbed in the lungs. In humans, the lung clearance (amount present which is absorbed systemically) of *n*-hexane is on the order of 20-30%. Absorption takes place by passive diffusion through epithelial cell membranes. Absorption by the oral and dermal route has not been well characterized. Inhaled *n*-hexane distributes throughout the body; based on blood-tissue partition coefficients, preferential distribution would be in the order: body fat>>liver, brain, muscle>kidney, heart, lung>blood. *n*-Hexane is metabolized by mixed function oxidases in the liver to a number of metabolites, including the neurotoxicant 2,5-hexanedione. Approximately 10-20% of absorbed *n*-hexane is excreted unchanged in exhaled air, and 2,5-hexanedione is the major metabolite recovered in urine. *n*-Hexane metabolites in the urine and *n*-hexane in exhaled air do not account for total intake, suggesting that some of the metabolites of *n*-hexane enter intermediary metabolism.

2.3.1 Absorption

2.3.1.1 Inhalation Exposure

The absorption of inhaled *n*-hexane has been investigated in six healthy male volunteers (Veulemans et al. 1982). Three different trials were performed on each volunteer: 4-hour exposure at 102 ppm *n*-hexane; 4-hour exposure at 204 ppm, and exposure during exercise on a stationary bicycle ergometer at 102 ppm. Each trial was done at least two weeks apart. Lung clearance (from alveolar air to blood) and retention were calculated from *n*-hexane concentrations in inhaled and expired air. After exposure, *n*-hexane in exhaled air was measured for up to 4 hours to determine respiratory elimination. Retention of *n*-hexane (calculated from lung clearance and respiratory minute volume) was approximately 20-25% of the *n*-hexane in the inhaled air. This resulted in calculated absorption rates of 0.84 mg/min at 102 ppm and

2. HEALTH EFFECTS

1.59 mg/min at 204 ppm. Retention was about the same at both concentrations, indicating that metabolism had not been saturated. Physical exercise at 102 ppm caused a significant increase in lung clearance and at peak loads (60 watts) was more than twice the value at rest, resulting in an increase in absorption rate. Pulmonary excretion of *n*-hexane after exposure ended appeared to be biphasic, with a fast drop in the first 30 minutes and a slower drop for the remainder of the 4-hour observation period. Blood concentrations of *n*-hexane reached steady-state within 100 minutes and were stable until the end of exposure. After exposure, there was a rapid fall to about 50% of the level at the end of exposure in the first 10 minutes, followed by a slower exponential time course with a half-life of 1.5-2 hours.

In a workplace study, lung uptake and excretion of *n*-hexane were studied in 10 workers (sex not specified, 18-30 years old) in a shoe factory (Mutti et al.1984). Simultaneous samples of inhaled and alveolar air (last 100 mL of the tidal volume) were collected 6 times during an 8-hour workday. Breathing-zone air was collected with personal samplers. Median time-weighted average *n*-hexane concentrations were 243 mg/m³ (69 ppm). 2-Methylpentane, 3-methylpentane, cyclohexane, and *n*-heptane were also present in the air. Alveolar excretion was monitored during a 6-hour post-exposure period. Uptake was calculated from lung ventilation, the retention coefficient ($1 - [C_{\text{alv}}/C_{\text{inh}}]$), and environmental concentrations. The total amount of exhaled *n*-hexane was calculated by integration of the decay curve for the concentration of exhaled *n*-hexane. About 25% of inhaled *n*-hexane was retained in the alveoli. Absorption into the blood in relation to total respiratory uptake was about 17%, taking into account the retention coefficient and alveolar ventilation.

2.3.1.2 Oral Exposure

No studies were located that specifically addressed absorption of *n*-hexane after oral exposure in humans or animals. Absorption of *n*-hexane by the oral route in humans can be inferred from the appearance of *n*-hexane in exhaled air and 2,5-hexanedione in urine of volunteers receiving 0.24 or 0.81 mg/kg via a gastric feeding tube (Baelum et al.1998). Absorption of toxicologically significant amounts by this route can be inferred since neurological effects occurred in rats receiving *n*-hexane by gavage (Krasavage et al. 1980; Ono et al.1981). Significant serum levels of the *n*-hexane metabolite 2,5-hexanedione were also measured in rats receiving *n*-hexane by gavage (Krasavage et al.1980).

2. HEALTH EFFECTS

2.3.1.3 Dermal Exposure

The permeability of human skin to *n*-hexane has been determined *in vitro* in flow-through diffusion cells (Loden 1986). Pieces of full-thickness human skin were exposed to [³H]*n*-hexane in human serum, and the appearance of label in the *trans* compartment measured for 0.5 or 12 hours. The skin was then sectioned with a microtome into 0.25 mm slices and the quantity of label in the skin measured. The rate of resorption (uptake of substance by the receptor fluid beneath the skin [i.e., the amount that passes through the skin]) was calculated. The rate of resorption for *n*-hexane through human skin was calculated to be 0.83 (μg * cm²/hr). The permeability of *n*-hexane through human skin was much lower (approximately 100-fold) than for other chemicals tested in this study. For example, rates of resorption (in μg * cm²/hr) were 99 for benzene and 118 for ethylene glycol.

No information is available on whether absorption of *n*-hexane by children differs from that of adults. Since absorption by all routes appears to be by passive diffusion, it is probable that absorption in children is similar to that of adults.

2.3.2 Distribution

Partition coefficients of a series of aliphatic hydrocarbons, including *n*-hexane, have been determined in human tissues (Perbellini et al. 1985). The following partition coefficients for *n*-hexane (olive oil/air, blood/air, tissue/air) were determined: olive oil, 146; blood, 0.80; liver, 5.2; kidney, 3; brain, 5; fat, 104; muscle, 5; heart, 2.8; and lung, 1. Saline/air partition was not reported separately for *n*-hexane, but was very low for the range reported for the entire group of compounds (0.1-0.4).

Partition coefficients have also been reported for human milk from a group of 8 volunteers (Fisher et al. 1997). The milk/air coefficient was 4.66 and the blood/air coefficient was 2.13. A milk/blood partition coefficient of 2.10 was calculated from this data.

Partition coefficients for *n*-hexane in male Fischer 344 rats have been reported (blood/air, tissue/air): blood, 2.29; liver, 5.2; muscle, 2.9; and fat, 159 (Gargas et al. 1989).

No information is available on whether distribution of *n*-hexane in children differs from that of adults. Transfer across the placenta has been demonstrated in rats for *n*-hexane and two resulting metabolites,

2. HEALTH EFFECTS

2-hexanone and 2,5-hexanedione (Bus et al.1979); no preferential distribution to the fetus was observed for either *n*-hexane or the metabolites. *n*-Hexane has not been measured in breast milk, although a milk/blood partition coefficient of 2.10 (Fisher et al.1997) ,indicates there would be preferential distribution to this compartment. Due to its relatively rapid metabolism, storage of *n*-hexane in body fat does not appear to occur at air concentrations to which humans are exposed; thus, there is unlikely to be mobilization of stored *n*-hexane upon pregnancy or lactation. The toxic metabolite of *n*-hexane, 2,5-hexanedione, can probably be distributed to germ cells as demonstrated by the testicular effects observed in male rats after drinking water exposure to 2,5-hexanedione. High air concentrations of *n*-hexane can also produce these effects in rats, presumably via 2,5-hexanedione (see Section 2.1.1.5).

2.3.2.1 Inhalation Exposure

In a study where blood *n*-hexane concentrations were determined in volunteers during exposure to 102 or 204 ppm for 4 hours, blood *n*-hexane reached steady-state within 100 minutes and was stable until the end of exposure. Concentrations of *n*-hexane in blood at 100 minutes were 0.202 mg/L at 102 ppm and 0.357 mg/L at 204 ppm. After exposure, there was a rapid fall to about 50% of the level at the end of exposure in the first 10 minutes and a slower exponential time course with a half-life of 1.5-2 hours (Veulemans et al.1982).

In Fischer 344 rats exposed to up to 10,000 ppm *n*-hexane for 6 hours, *n*-hexane achieved an apparent steady state in all tissues within 2 hours (Baker and Rickert 1981). Steady-state concentrations were proportional to dose only in blood and liver. In brain, sciatic nerve, kidney, lung, and testes, exposure to 1,000 ppm resulted in a disproportionately greater concentration than exposure at 500 ppm. Peak blood concentrations of *n*-hexane were 1, 2, 8, and 21 µg/mL, and peak sciatic nerve concentrations were 12, 48, 130, and 430 µg/g at 500, 1,000, 3,000, and 10,000 ppm, respectively. In a study that addressed possible accumulation of *n*-hexane in tissues, *n*-hexane was not detected in any tissue besides sciatic nerve after 2 hours post-exposure in either 1 or 5 day exposures to *n*-hexane at 1,000 ppm for 6 hours a day (Bus et al. 1981). Initial concentrations after a single exposure were: sciatic nerve, 46 µg/g; kidney, 5.8 µg/g; liver, 1.2 µg/g; brain, 3 µg/g, and blood, 0.5 µg/mL. Initial concentrations after 5 daily exposures were similar. No significant difference was found between *n*-hexane blood concentrations in mothers (0.45±0.11 µg/mL) and total fetal concentration (0.61±0.14 µg/g wet weight) after exposure during pregnancy (Bus et al. 1979), indicating that transfer across the placenta takes place. Initial concentrations of *n*-hexane in maternal tissues were: liver, 0.85 µg/g; kidney, 6.33 µg/g; and brain, 0.04 µg/g.

2. HEALTH EFFECTS

2.3.2.2 Oral Exposure

No studies were located regarding distribution of *n*-hexane after oral exposure in humans or animals.

2.3.2.3 Dermal Exposure

No studies were located regarding distribution of *n*-hexane after dermal exposure in humans or animals.

2.3.3 Metabolism

The metabolism of *n*-hexane takes place in the liver. The initial reaction is oxidation by cytochrome P-450 isozymes to hexanols, predominantly 2-hexanol. Further reactions convert 2-hexanol to 2-hexanone, 2,5-hexanediol, 5-hydroxy-2-hexanone, 4,5-dihydroxy-2-hexanone and the neurotoxicant 2,5-hexanedione. Hydroxylation at the 1- and 3- positions can be considered detoxification pathways; hydroxylation at the 2- position is a bioactivation pathway. A diagram of the proposed pathway for mammalian metabolism of *n*-hexane is presented in Figure 2-3.

Approximately 10-20% of *n*-hexane absorbed by inhalation is excreted unchanged in exhaled air; the remainder is metabolized. Metabolism takes place via mixed-function oxidase reactions in the liver. In a study in which metabolites were measured in workers exposed to *n*-hexane (Perbellini et al.1981), mean concentrations of *n*-hexane metabolites in urine were: 2,5-hexanedione, 5.4 mg/L; 2,5-dimethylfuran, 3.7 mg/L; gamma-valerolactone, 3.3 mg/L; and 2-hexanol, 0.19 mg/L. (2,5-Dimethylfuran and gamma-valerolactone are believed to be artifacts of sample preparation and analysis rather than true metabolites of *n*-hexane [Perbellini et al.1981]). The first reaction that takes place is hydroxylation of *n*-hexane at the 2 position to form 2-hexanol. Further reactions result in 2,5-hexanedione, presumably through transient intermediates, including 2-hexanone, 2,5-hexanediol, and 5-hydroxy-2-hexanone. Correlations between concentrations of *n*-hexane in air and urinary metabolites were best for total *n*-hexane metabolites ($r=0.7858$), followed by 2-hexanol ($r=0.6851$) and 2,5-hexanedione ($r=0.6725$).

The time-course of the metabolism of inhaled *n*-hexane in a group of 19 volunteers has been estimated by determining serum 2,5-hexanedione during and after a 15.5~minute exposure to 60 ppm *n*-hexane (van Engelen et al.1997). The time to reach the peak concentration varied from 16.2 to 19.8 minutes after the

Figure 2-3. Proposed Scheme for the Metabolism of *n*-Hexane

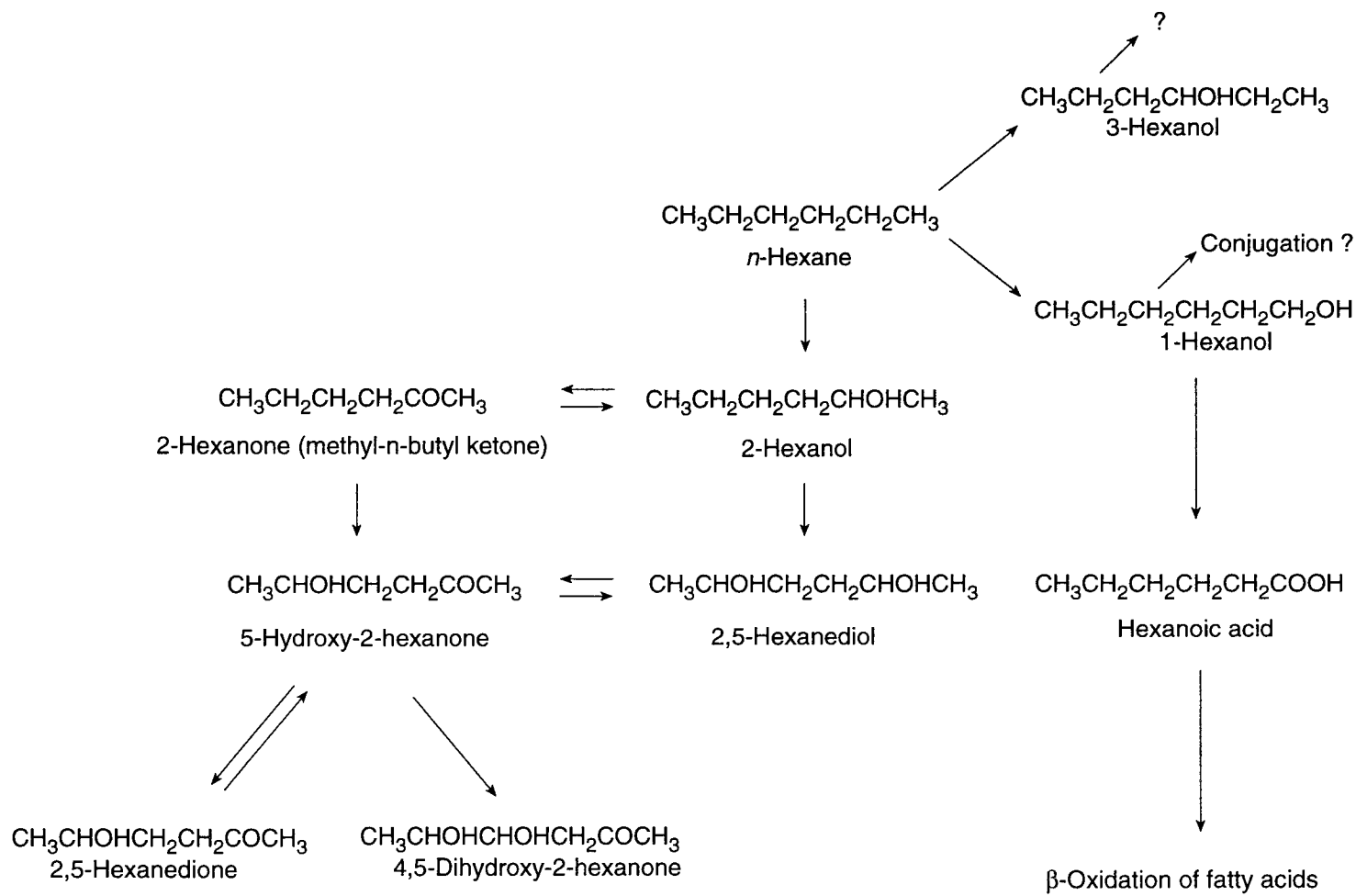

Source: Modified from NTP 1991

2. HEALTH EFFECTS

start of exposure (i.e., 1-4 minutes following the cessation of exposure). The rate at which 2,5-hexanedione appeared in the blood ranged from 1.89 to 4.48 $\mu\text{M}/\text{hour}$.

Further studies in humans indicate that a large proportion of the 2,5-hexanedione detected in urine after *n*-hexane exposure is the result of an artifact resulting from treatment with acid to hydrolyze urinary conjugates (Fedtke and Bolt 1987). When urine from a male volunteer exposed to 217 ppm *n*-hexane for 4 hours was hydrolyzed enzymatically with β -glucuronidase, excretion of 4,5-dihydroxy-2-hexanone was approximately 4 times higher than that of 2,5-hexanedione. When the urine was hydrolyzed with acid, 4,5-dihydroxy-2-hexanone was not detected, but the amount of 2,5-hexanedione in the urine increased, indicating conversion of 4,5-dihydroxy-2-hexanone to 2,5-hexanedione by the acid treatment. The fraction of 2,5-hexanedione determined after complete acid hydrolysis minus the 2,5-hexanedione originally present was equal to the 4,5-dihydroxy-2-hexanone. Only "minor" amounts of 2-hexanol were reported.

2,5-Hexanedione has also been detected after acid hydrolysis of the urine of individuals unexposed to *n*-hexane (Fedtke and Bolt 1986a; Perbellini et al. 1993). 2,5-Hexanedione was not detected without acid hydrolysis, indicating that it is formed as a result of conversion of 4,5-dihydroxy-2-hexanone. It is possible that small amounts of *n*-hexane are produced in the body by lipid peroxidation, as has been demonstrated for *n*-pentane (Filser et al. 1983). Urinary excretion of 2,5-hexanedione ranged from 0.3 to 1.2 mg in 24 hours for unexposed individuals; workers exposed to approximately 50 ppm *n*-hexane excreted 3-4 mg/24 hours (Perbellini et al. 1993).

When male Wistar rats were exposed to *n*-hexane at concentrations up to 3,074 ppm for 8 hours, analysis of urine showed that 2-hexanol was the major metabolite, accounting for about 60-70% of the total metabolites collected over the 48-hour collecting period (Fedtke and Bolt 1987). This is in contrast to humans, in which the major urinary metabolite is 2,5-hexanedione (Perbellini et al. 1981). The amounts of metabolites excreted were linearly dependent on the exposure concentration, up to an exposure of about 300 ppm. 2-Hexanol and 2-hexanone were detected in the first sample (obtained during the 8-hour exposure); excretion of 2,5-hexanedione was delayed and was not detected until 8-16 hours after exposure began. The amount of 2,5-hexanedione detected depended on sample treatment; total excreted amounts over 48 hours were approximately 350 $\mu\text{g}/\text{kg}$ 2,5-hexanedione without acid treatment and 3,000 $\mu\text{g}/\text{kg}$ with total acid hydrolysis, indicating conversion of 4,5-dihydroxy-2-hexanone with acid treatment.

2. HEALTH EFFECTS

The metabolism of *n*-hexane in rat lung and liver microsomes has been investigated (Toftgard et al.1986). In liver microsomes, the formation of 1-, 2-, and 3-hexanol from *n*-hexane was best described kinetically by a 2-enzyme system, while for lung microsomes, single-enzyme kinetics were indicated for each metabolite. For conversion to 1-hexanol, apparent K_m values were 0.4 and 300 μ M, and V_{max} values were 0.09 and 1.2 nmol/mg protein/min, respectively. For conversion to 2-hexanol, apparent K_m values were 6 and 100 μ M, and V_{max} values were 1 and 4.6 nmol/mg protein/min respectively. Insufficient information was available to estimate the high-affinity activity for 3-hexanol, the low-affinity activity had an apparent K_m of 290 pM and a V_{max} of 0.5 nmol/mg protein/min. In the lung, K_m values were 9, 50, and 65 μ M for 1-, 2-, and 3-hexanol, respectively; V_{max} values were 2.2, 1.3, and 0.2 nmol/mg protein/minute, respectively. Prior induction of P-450 enzymes with phenobarbital markedly increased the rate of formation of 2-hexanol in liver microsomes (1.8 nmol/mg/min control versus 15 nmol/mg/min with phenobarbital) and that of 3-hexanol(0.4 versus 2.8), while the rate of formation of 1-hexanol fell slightly (2 versus 0.7). Antibodies to P-450 isozymes PB-B (CYP2B1-inducible by phenobarbital) and BNF-B (CYP1A1-inducible by *fi*-naphthoflavone) were used as inhibitors to investigate the specificity of the reactions. In control liver microsomes, anti-PB-B showed no inhibitory effects while anti-BNF-B inhibited the formation of 2- and 3-hexanol by 25 and 40%, respectively, but had no effect on the formation of 1-hexanol. In microsomes from rats induced with phenobarbital, the anti-PB-B antibody reduced the formation of hexanols back to control levels. Purified P-450 isozymes were also tested for their ability to hydroxylate *n*-hexane. The highest activity (nmol metabolite/nmol P-450/min) was found with P-450-PB-B (CYP2B1), followed by P-450-PB-D (CYP2B2) and P-450-BNF-B (CYP1A1). Formation of 2,5-hexanediol from 2-hexanol was catalyzed by a P-450 isozyme different from cytochrome P-450-PB-B (as judged by antibody inhibition) that was present in liver but not in lung microsomes. This process was unaffected by prior induction of cytochrome P-450. Furthermore, alcohol dehydrogenase activity with hexanols or 2,5-hexanediol as the substrate was found exclusively in liver cytosol. These results suggest that inhaled *n*-hexane must be transported to the liver either intact or in the form of 2-hexanol before the neurotoxic metabolite 2,5-hexanedione can be formed. The large increase in hydroxylation of *n*-hexane upon induction (which would favor the production of 2,5-hexanedione via 2-hexanol) is a likely explanation for the potentiating effects of methyl ethyl ketone on *n*-hexane neurotoxicity in humans and rats (Altenkirch et al.1977, 1982) and of methyl isobutyl ketone in chickens (Abou-Donia et al.1985).

The tissue and P-450 isoform specificity of *n*-hexane hydroxylation to hexanols has been investigated in rat tissues and cell lines expressing specific P-450 isoforms (Crosbie et al.1997). The highest activity per mg protein for the production of 2-hexanol (which can be further metabolized to 2,5-hexanedione) was in liver,

2. HEALTH EFFECTS

followed by lung (about 25% of liver activity), muscle and brain. Activity in muscle and brain was very low compared to the liver. Membrane preparations from cells expressing human CYP2E1 had the same *n*-hexane 2-hydroxylation activity as control cells. In contrast, cells expressing human CYP2B6 had approximately 100 times the 2-hydroxylation activity of the CYP2E1 or control cells. Specific induction of the cytochrome P-450 isozyme CYP2E1 has been reported in male Wistar rats after intraperitoneal injection of *n*-hexane (Nakajima et al.1991). No effects on total liver microsomal protein or total cytochrome P-450 content were observed. trans-1,2-Dichloromethylene (DCE), a specific inhibitor of CYP2E1 in rats, has also been shown to affect the metabolism of *n*-hexane (Mathews et al.1997). Rats exhale a large number of endogenous volatile organic compounds, including *n*-hexane. When CYP2E1 was inhibited by intraperitoneal injection of DCE, levels of exhaled *n*-hexane increased approximately 25-fold within 4 hours and returned to pre-dose levels at approximately 24 hours, closely paralleling the inhibition and resynthesis time-course for CYP2E1. No increase in lipid peroxidation was observed, indicating that the increase in exhaled *n*-hexane was the result of inhibition of metabolism. It is probable that many P-450 isoforms are capable of hydroxylating *n*-hexane (both *in vivo* and under laboratory conditions); it is not possible at this time to specify which forms are definitely involved in *n*-hexane metabolism *in vivo*.

The effect of concentration on the fate of [¹⁴C]*n*-hexane after inhalation exposure has been studied in Fischer 344 rats (Bus et al.1982). The disposition of radioactivity was dose-dependent, with 12, 24, 38, and 62% of the acquired body burden excreted as *n*-hexane by the lung with increasing exposure concentration (500, 1,000, 3,000, and 10,000 ppm, respectively). In contrast, 38, 31, 27, and 18% of the body burden of radioactivity was recovered as expired CO₂ and 35,40, 31, and 18% was recovered in the urine with increasing *n*-hexane concentration (expired air and urine were collected for 72 hours after exposure). Radioactivity remaining in the tissues and carcass 72 hours after exposure represented 6.1, 8.8, 7.4, and 5.4% of the body burden for the respective exposures. The dose-dependent elimination of radioactivity was apparently due in part to an inhibition of *n*-hexane metabolism reflected by a decrease in total ¹⁴CO₂ and urinary ¹⁴C excretion after 10,000 ppm exposure compared to the 3,000 ppm exposure. Half-lives for excretion were estimated from the data. Urinary half-time for excretion of radioactivity was 12.7 hours at 500 ppm.

In a study in which pregnant rats received a single 6-hour exposure to 1,000 ppm *n*-hexane on gestation day 12 or 20 (Bus et al.1979), *n*-hexane was rapidly and extensively metabolized to methyl-*n*-butyl ketone (2-hexanone) and 2,5-hexanedione. 2-Hexanone and 2,5-hexanedione (the only metabolites measured) were

2. HEALTH EFFECTS

detected in the maternal liver, kidney, brain, and blood. Fetal concentrations of *n*-hexane and its metabolites (entire fetus) were similar to those in maternal blood at all times after exposure. Results were similar on both gestation days 12 and 20. *n*-Hexane and 2-hexanone were rapidly eliminated from maternal tissues and the fetus, with minimal or nondetectable concentrations reached 8 hours after exposure. In contrast, tissue concentrations of 2,5-hexanedione increased between 0 and 4 hours after exposure and thereafter exhibited a significantly slower elimination rate compared to *n*-hexane and 2-hexanone. 2,5-Hexanedione was not detected in the blood or tissues 24 hours after exposure. The half-life of 2,5-hexanedione in maternal blood was significantly greater than *n*-hexane and 2-hexanone (3.9 hours versus 1.24 and 0.99 hours, respectively).

Concentration time curves for *n*-hexane in a closed exposure system indicated that metabolism in rats was proportional to air concentration up to about 300 ppm (Filser et al.1987). Metabolism was non-linear above 300 ppm and appeared to be saturated at concentrations $\geq 3,000$ ppm.

Little information is available on the metabolism of *n*-hexane after oral exposure, although it appears to be qualitatively similar to that after inhalation exposure. Peak serum concentrations of the *n*-hexane metabolite 2,5-hexanedione of 24, 44, and 53 $\mu\text{g}/\text{mL}$ were observed in rats after a single gavage exposure to 570, 1,140, and 4,000 mg/kg *n*-hexane, respectively (Krasavage et al.1980). Serum 2,5-hexanedione concentrations rose slowly to a peak at 12-16 hours and returned to baseline by 24 hours.

Exposure to other chemicals can influence the metabolism of *n*-hexane. The effect of oral pretreatment with methyl ethyl ketone (MEK) on the metabolism of inhaled *n*-hexane was investigated in male Fischer 344 rats (Robertson et al.1989). Groups of 2-4 rats were given MEK (1.87 mL/kg, approximately 1,500 mg/kg) by gavage for 4 days prior to a single 6-hour inhalation exposure to *n*-hexane (1,000 ppm). Animals were sacrificed at 0, 1, 2, 4, 6, 8, and 18 hours after exposure ended, and samples of blood, liver, testis, and sciatic nerve were obtained and analyzed for *n*-hexane, MEK, and their metabolites. Significant increases in the levels of the neurotoxic metabolite 2,5-hexanedione and 2,5-dimethylfuran (derived from 2,5-hexanedione) were found in blood and sciatic nerve of rats pretreated with MEK. Levels of 2,5-hexanedione in blood were approximately 10-fold higher than control immediately after *n*-hexane exposure in rats and fell rapidly to approximately 2-fold after 6 hours. In sciatic nerve, increases in 2,5-hexanedione were approximately 6-fold at 2 hours and 3-fold at 4 hours. Similar patterns were found with 2,5-dimethylfuran. 2,5-Hexanedione was not detected in the testis of non-pretreated rats; levels were measurable but very low in pretreated rats (0.3-0.6 $\mu\text{g}/\text{g}$ compared to 10-12 $\mu\text{g}/\text{g}$ in blood or sciatic

2. HEALTH EFFECTS

nerve). 2,5-Dimethylfuran was significantly higher in testis (approximately 4-fold) in pretreated animals for the first 6 hours after exposure. 2,5-Hexanedione was not detected in the liver in any group, although 2,5-dimethylfuran was. 2-Hexanol and 2-hexanone were detected in some samples but in small amounts. 5-Hydroxy-2-hexanone amounts were similar to those found with 2,5-hexanedione but were more variable.

In this study, P-450-related enzyme activities (benzphetamine *N*-demethylase, 7-ethoxycoumarin O-deethylase) were also measured in liver homogenates (prepared 24 hours after the last treatment) from rats treated orally with MEK for 1-7 days and compared to the activity obtained with phenobarbital treatment (80 mg/kg intraperitoneally for 3 days) (Robertson et al. 1989). Total cytochrome P-450 was also measured. No consistent change was noted in benzphetamine *N*-demethylase activity as the result of MEK treatment, while 7-ethoxycoumarin O-deethylase was over 3 times higher than controls and comparable to phenobarbital induction. Total P-450 levels were increased to approximately 150-200% of controls with MEK and to 570% of control by phenobarbital. The authors concluded that the potentiating effects of MEK on the neurotoxicity of *n*-hexane appear to arise, at least in part, from the activating effects of MEK on selected microsomal enzymes responsible for *n*-hexane activation.

Rats pretreated with xylene or phenobarbital and then exposed to *n*-hexane by inhalation exhibited a markedly increased peak serum concentration of 2,5-hexanedione (Toftgard et al. 1983). Peak serum concentrations were approximately 4 µg/mL in control rats, 11 µg/mL in xylene-induced rats, and 13 µg/mL in phenobarbital-induced rats. Peaks were reached in 1-2 hours. The half-life for elimination from serum was approximately one hour for both pretreated and untreated rats. The high serum 2,5-hexanedione concentrations were correlated with an induction of liver microsomal P-450 content (0.56 nmol/mg protein in control rats, 1.03 nmol/mg in xylene-induced rats, and 1.7 nmol/mg protein in phenobarbital-induced rats, respectively).

No information is available as to whether metabolism of *n*-hexane in children differs from that of adults. No studies were located comparing metabolism in young and adult animals. The toxicity of *n*-hexane results from biotransformations yielding the active metabolite, 2,5-hexanedione. The initial step is an oxidation to 2-hexanol catalyzed by a cytochrome P-450 enzyme. Some P-450 enzymes are developmentally regulated (Leeder and Kearns 1997). As the above discussion indicates, it is not completely clear which P-450 enzymes are involved in *n*-hexane metabolism.

2. HEALTH EFFECTS

2.3.4 Elimination and Excretion

No information is available as to whether excretion of *n*-hexane and its metabolites in children differs from that of adults. No studies were located comparing excretion in young and adult animals.

2.3.4.1 Inhalation Exposure

In a study of workers exposed to *n*-hexane (Mutti et al.1984), the post-exposure alveolar excretion of *n*-hexane was about 10% of the total uptake, and was in 2 phases: a fast phase with a half-life of 11 minutes and a slow phase with a half-life of 99 minutes. Urinary metabolite concentrations were lowest at the beginning of the shift, highest at the end of the shift, and still elevated the next morning. Half-life for urinary excretion of total *n*-hexane metabolites (2,5dimethylfuran, 2-hexanol, 2,5-hexanedione, and gamma-valerolactone were detected) in another group of exposed workers was 13-14 hours (Perbellini et al.1981, 1986). There was a strong correlation ($r=0.967$) between time-weighted average *n*-hexane air concentration and end of shift 2,5-hexanedione in the urine; end-of-shift samples gave the best estimate of overall exposure. The authors calculated that about 3 mg of 2,5-hexanedione/g creatinine would correspond to about 50 ppm of *n*-hexane in the air (mean daily exposure).

2.3.4.2 Oral Exposure

Excretion of *n*-hexane after oral exposure in humans can be inferred from the appearance of *n*-hexane in exhaled air and 2,5-hexanedione in urine of volunteers receiving 0.24 or 0.81 mg/kg via a gastric feeding tube (Baelum et al.1998). No studies were located regarding excretion of *n*-hexane or *n*-hexane metabolites following oral exposure to *n*-hexane in animals.

2.3.4.3 Dermal Exposure

No studies were located regarding excretion of *n*-hexane or *n*-hexane metabolites following dermal exposure to *n*-hexane.

2. HEALTH EFFECTS

2.3.5 Physiologically based Pharmacokinetic (PBPK)/Pharmacodynamic (PD) Models

Physiologically based pharmacokinetic (PBPK) models use mathematical descriptions of the uptake and disposition of chemical substances to quantitatively describe the relationships among critical biological processes (Krishnan et al. 1994). PBPK models are also called biologically based tissue dosimetry models. PBPK models are increasingly used in risk assessments, primarily to predict the concentration of potentially toxic moieties of a chemical that will be delivered to any given target tissue following various combinations of route, dose level, and test species (Clewell and Andersen 1985). Physiologically based pharmacodynamic (PBPD) models use mathematical descriptions of the dose-response function to quantitatively describe the relationship between target tissue dose and toxic end points.

PBPK/PD models refine our understanding of complex quantitative dose behaviors by helping to delineate and characterize the relationships between: (1) the external/exposure concentration and target tissue dose of the toxic moiety, and (2) the target tissue dose and observed responses (Andersen et al. 1987; Andersen and Krishnan 1994). These models are biologically and mechanistically based and can be used to extrapolate the pharmacokinetic behavior of chemical substances from high to low dose, from route to route, between species, and between subpopulations within a species. The biological basis of PBPK models results in more meaningful extrapolations than those generated with the more conventional use of uncertainty factors.

The PBPK model for a chemical substance is developed in four interconnected steps: (1) model representation, (2) model parametrization, (3) model simulation, and (4) model validation (Krishnan and Andersen 1994). In the early 1990s validated PBPK models were developed for a number of toxicologically important chemical substances, both volatile and nonvolatile (Krishnan and Andersen 1994; Leung 1993). PBPK models for a particular substance require estimates of the chemical substance-specific physicochemical parameters, and species-specific physiological and biological parameters. The numerical estimates of these model parameters are incorporated within a set of differential and algebraic equations that describe the pharmacokinetic processes. Solving these differential and algebraic equations provides the predictions of tissue dose. Computers then provide process simulations based on these solutions.

The structure and mathematical expressions used in PBPK models significantly simplify the true complexities of biological systems. If the uptake and disposition of the chemical substance(s) is adequately described, however, this simplification is desirable because data are often unavailable for many biological processes. A simplified scheme reduces the magnitude of cumulative uncertainty. The adequacy of the

2. HEALTH EFFECTS

model is, therefore, of great importance, and model validation is essential to the use of PBPK models in risk assessment.

PBPK models improve the pharmacokinetic extrapolations used in risk assessments that identify the maximal (i.e., the safe) levels for human exposure to chemical substances (Andersen and Krishnan 1994). PBPK models provide a scientifically-sound means to predict the target tissue dose of chemicals in humans who are exposed to environmental levels (for example, levels that might occur at hazardous waste sites) based on the results of studies where doses were higher or were administered in different species. Figure 2-4 shows a conceptualized representation of a PBPK model.

A PBPK model for *n*-hexane is discussed below. The overall results and model are discussed in this section in terms of use in risk assessment, tissue dosimetry, and dose, route, and species extrapolations.

2.3.5.1 Summary of PBPK Models.

The Perbellini model for *n*-hexane (Perbellini et al. 1986, 1990a) is an 8-compartment model which simulates the absorption, distribution, biotransformation, and excretion of *n*-hexane during inhalation exposure. The excretion kinetics of the neurotoxic metabolite of *n*-hexane, 2,5-hexanedione, are also simulated.

A model describing transfer of *n*-hexane via lactation from a mother to a nursing infant is also available (Fisher et al. 1997). Human milk/blood partition coefficients for 19 volatile organic chemicals including *n*-hexane were experimentally determined using samples from volunteers. These parameters were used to estimate the amount of *n*-hexane an infant would ingest from milk if the mother was occupationally exposed to *n*-hexane at the Threshold Limit Value (TLV) throughout a workday.

2.3.5.2 n-Hexane PBPK Model Comparison.

The Perbellini PBPK model for *n*-hexane is the only validated model for this chemical identified in the literature. The Fisher model was intended for risk assessment to predict which of 19 volatile organic chemicals may be present in milk at a high enough level after workplace exposure to raise health concerns for a nursing infant.

2. HEALTH EFFECTS

Figure 2-4. Conceptual Representation of a Physiologically Based Pharmacokinetic (PBPK) Model for a Hypothetical Chemical Substance

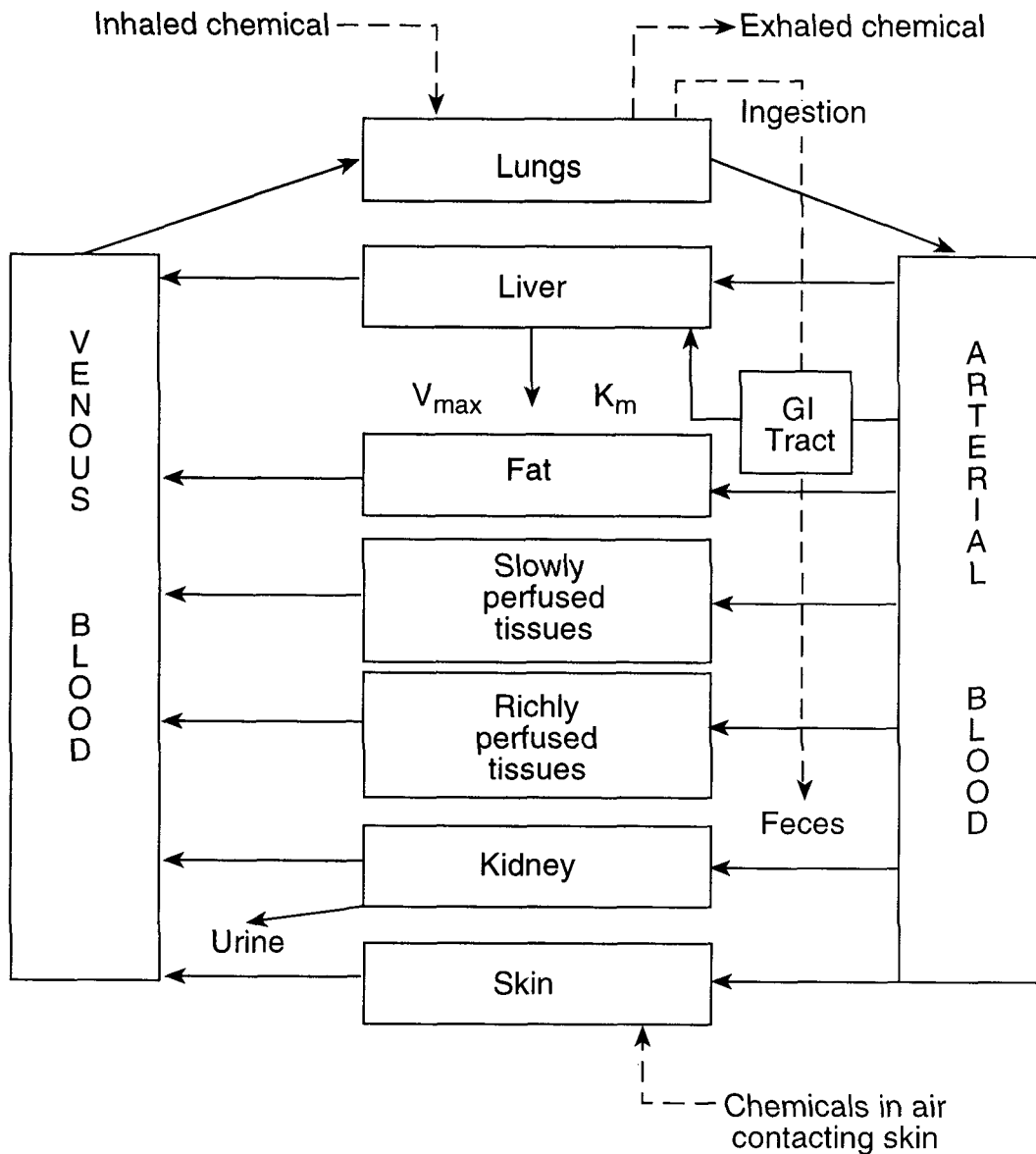

Source: adapted from Krishnan et al. 1994

Note: This is a conceptual representation of a physiologically based pharmacokinetic (PBPK) model for a hypothetical chemical substance. The chemical substance is shown to be absorbed via the skin, by inhalation, or by ingestion, metabolized in the liver, and excreted in the urine or by exhalation.

2. HEALTH EFFECTS

2.3.5.3 Discussion of Models.**The Perbellini Model.**

Risk assessment. The Perbellini model successfully described alveolar air and venous blood concentrations of *n*-hexane following inhalation exposure in humans. Simulations indicated that exposure to 50 ppm for an 8-hour-workday, 5-day workweek would result in a gradual accumulation of *n*-hexane in body fat which is not completely cleared during the weekend.

Description of the model. The Perbellini model has eight compartments (See Figure 2-5):

1. A lung compartment where *n*-hexane arrives via inhalation and reaches a concentration that also depends on the *n*-hexane concentration in the alveolar air, in the arterial blood, and in the venous blood;
2. a vessel rich tissue compartment (VRG) including the heart, brain, and kidney;
3. a muscle tissue compartment (MG);
4. a fat tissue compartment (FG);
5. liver tissue compartment #1 describing the input and output of *n*-hexane (catabolism of *n*-hexane);
6. liver tissue compartment #2 describing the synthesis and transfer of 2,5-hexanedione;
7. water compartment concerned with the distribution of 2,5-hexanedione; and
8. urine compartment where 2,5-hexanedione is excreted.

It is assumed that the *n*-hexane concentration instantaneously reaches a balance between alveolar air and arterial blood and the *n*-hexane concentration in venous blood is in constant and dynamic balance with the corresponding tissue concentrations.

Physiological parameters for volumes and blood flow of the compartments are listed in Table 2-4. Physiologic constants (compartment volume, blood flows, etc) were taken from published values. Values for the solubility of *n*-hexane in blood and tissues (partition coefficients) are taken from human tissue (Perbellini et al. 1985). Rate constants (Table 2-4, Figure 2-5) were estimated from animal and human data and are all assumed to be first-order.

2. HEALTH EFFECTS

Figure 2-5. Perbellini PBPK Model

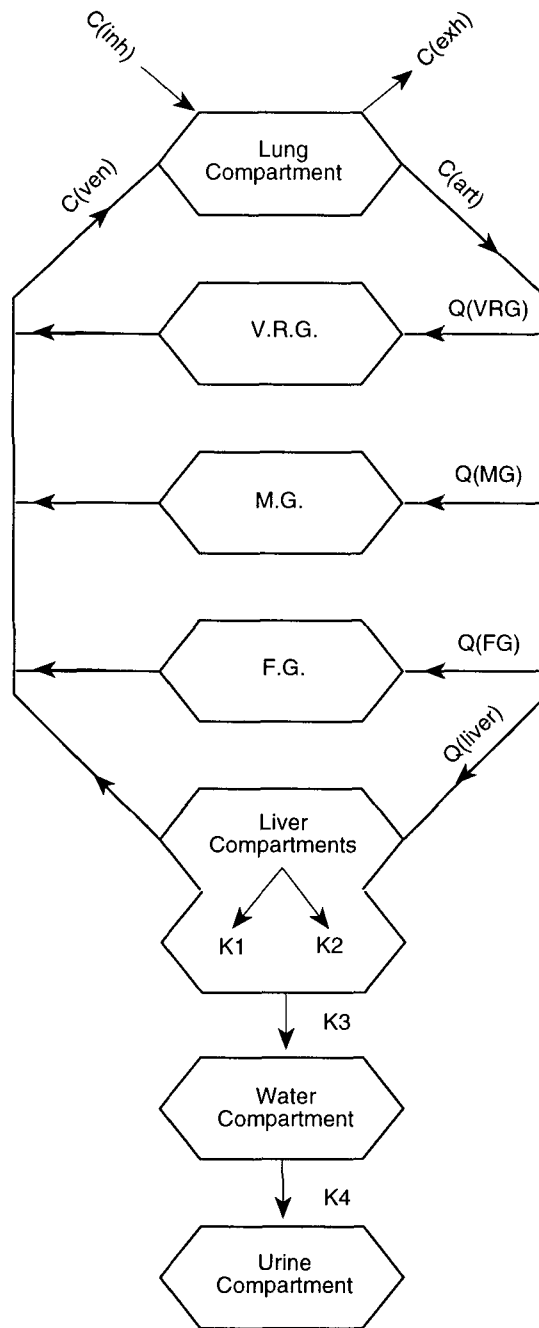

Source: Perbellini et al. 1986

$C(ven)$ = concentration of *n*-hexane in venous blood; $C(inh)$ = concentration of *n*-hexane in inhaled air; $C(exh)$ = concentration of *n*-hexane in exhaled air; $C(ar)$ = *n*-hexane in arterial blood; FG = fat tissue group; MG = muscle tissue group; VRG = vessel-rich tissue group

2. HEALTH EFFECTS

Table 2-4. Parameters Used in the Perbellini PBPK Model for *n*-Hexane

Parameters	Human
	<i>Compartment volumes (L)</i>
Liver	1.7
Lung	1.0
Fat	11.5
Vessel-rich compartment	7.1
Muscle compartment	36.3
	<i>Flows (L/min)</i>
Alveolar ventilation	6
Cardiac output	6.3
	<i>Percentage of cardiac output</i>
Liver	25.0
Fat	4.4
Vessel-rich compartment	55
Muscle compartment	16
	<i>Partition coefficients</i>
Blood/air	0.8
Liver/blood	6.5
Fat/blood	130
Vessel-rich compartment/blood	5
Muscle/blood	6.2
	<i>Metabolic constants (min⁻¹)</i>
k ₁ (catabolism of <i>n</i> -hexane to metabolites)	0.3
k ₂ (synthesis of 2,5-hexanedione from <i>n</i> -hexane)	0.012
k ₃ (transfer of 2,5-hexanedione to body water)	0.009
k ₄ (transfer of 2,5-hexanedione from body water to urine)	0.0009

Source: Perbellini et al. 1986, 1990b

2. HEALTH EFFECTS

Validation of the model. The Perbellini model was validated using a data set for venous blood *n*-hexane values in volunteers exposed for 4 hours (Veulemans et al.1982). The range in the study was 334-368 µg/L during exposure to 204 ppm; the model predicted a value within this range. After 4 hours exposure to 102 ppm, the predicted value for venous blood *n*-hexane concentration was about 10% below that actually observed in humans. The authors also compared their own data from previous studies on the correlation between venous blood *n*-hexane concentrations and workplace concentrations. From the correlation curve, exposure at 102 ppm would predict a venous blood concentration of 176 µg/L; the model predicted 182 µg/L. The urinary excretion rate of 2,5-hexanedione predicted by the model was also compared to a data set from 13 workers followed for 24 hours from the beginning of a workday. The model successfully predicted the rate of 2,5-hexanedione urinary excretion.

Target tissues. Target tissues were not specifically addressed in this model. The target tissue for *n*-hexane is peripheral nerve (via the neurotoxic metabolite 2,5-hexanedione).

Species extrapolation. No species extrapolation was attempted in this model. Results from *in vitro* studies in rat liver homogenates were used to estimate kinetic parameters for the catabolism of *n*-hexane and synthesis of 2,5-hexanedione.

Interroute extrapolation. No interrout extrapolation was attempted in this model.

The Fisher Model.

The Fisher model simulates the transfer of *n*-hexane from a mother to a nursing infant during and after occupational exposure via inhalation (Fisher et al.1997). The model is shown in Figure 2-6, and its parameters are presented in Table 2-5. Blood/air and milk/air partition coefficients were determined with samples from volunteers. Simulations were run over a 24-hour period at the *n*-hexane TLV value of 50 ppm assuming a 9-hour working period containing 2 half-hour and one 1-hour break periods and 8 nursing periods over 24 hours. Total *n*-hexane ingested in milk was compared to the EPA Health Advisory Intake for chronic ingestion of contaminated water by 10 kg children. The model predicted ingestion at the rate of 0.052 mg/day compared to the EPA advisory intake of 4.0 mg/day. Simulated inhalation exposures at the TLV level for some chemicals (e.g., bromochloroethane) resulted in infant exposures via milk that exceeded the EPA advisory intakes for contaminated water.

Risk assessment. The purpose of this study was risk assessment. The transfer to milk of 19 chemicals was simulated to predict those that may result in exposures to infants higher than the EPA

2. HEALTH EFFECTS

Figure 2-6. Fisher PBPK Model

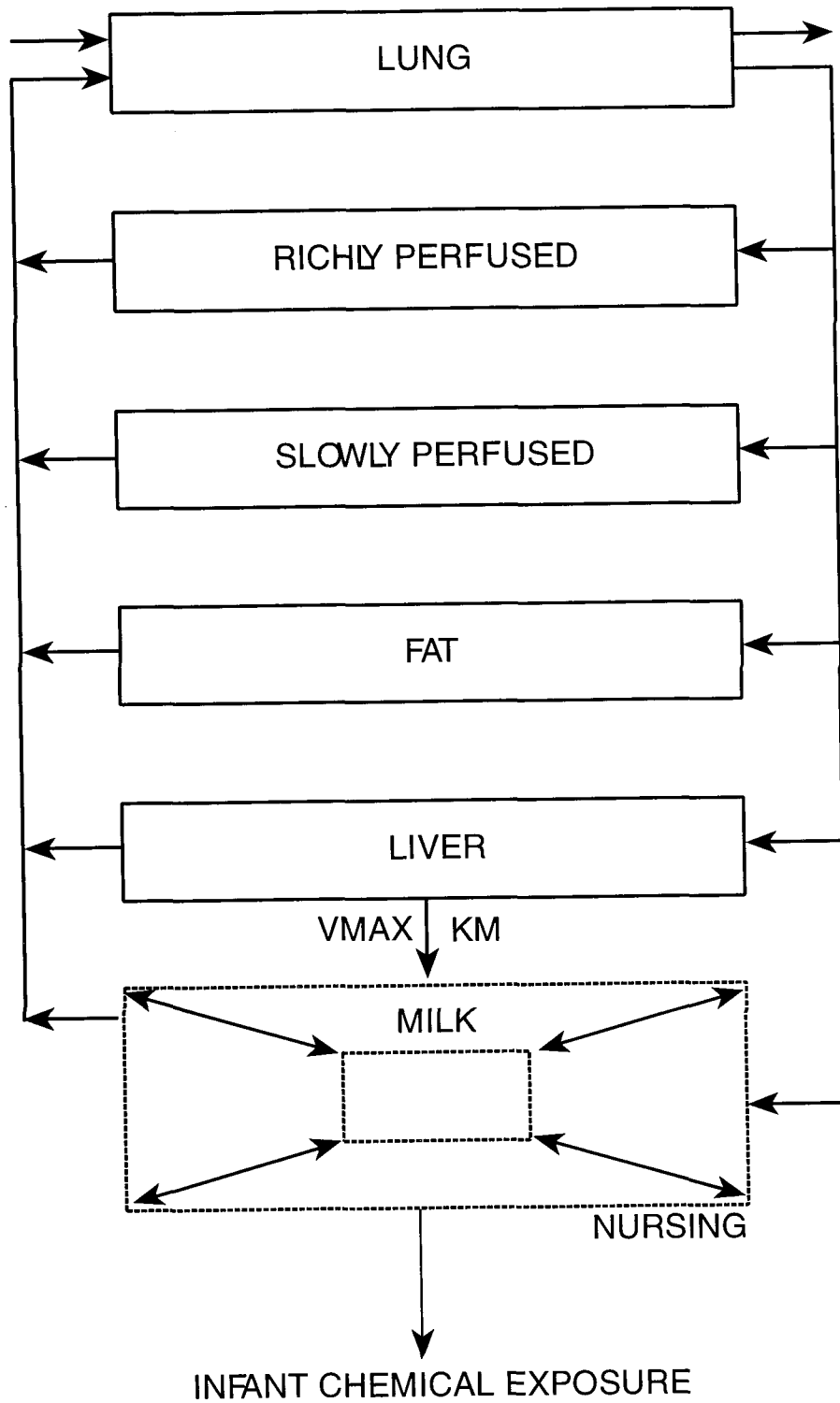

Source: Fisher et al. 1997

Milk compartment volume changes as a result of nursing.

2. HEALTH EFFECTS

Table 2-5. Parameters Used in the Fisher PBPK Model for *n*-Hexane

Parameters	Human
	% BW ^c (BW = 60 kg)
Liver	1.5
Richly perfused	10
Slowly perfused	54
Fat	25
Milk	10–125 mL
	<i>Flows (L/min)</i>
Alveolar ventilation	24 x BW ^{0.74}
Cardiac output	15 x BW ^{0.74}
	<i>Percentage of cardiac output</i>
Liver	29
Fat	410
Richly perfused	35
Slowly perfused	19
Milk	7
	<i>Partition coefficients</i>
Blood/air	2.13
Liver/blood	2.45
Fat/blood	74.74
Richly perfused blood	2.45
Slowly perfused blood	1.36
Milk/air	4.60
Milk/blood	2.10
	<i>Metabolic constants</i>
V _{max}	6.0 mg/kg/hr
K _m	0.3 mg/L
	<i>Milk compartment</i>
Nurse ^a	20/hr
Prod ^b	0.06 L/hr

^a Nurse is a first-order term to describe the rate of ingestion of breast milk by a nursing infant.

^b Prod is a zero-order term to describe the rate of breast milk production at 1.3–3 months of lactation.

^c Body weight

Source: Fisher et al. 1997

2. HEALTH EFFECTS

Drinking Water Health Advisory Values for ingestion of contaminated water. The predicted amount of *n*-hexane ingested was below this value.

Description of the model. The model contains seven compartments: alveolar space, lung blood, fat, slowly perfused tissues, rapidly perfused tissues, liver, and milk (see Figure 2-6). In this model, standard literature values were used for most parameters while blood/air and milk/air partition coefficients were determined experimentally (see Table 2-5). The milk/blood partition coefficient was derived from the blood/air and milk/air coefficients. Maximum rates of hepatic metabolism (V_{\max}) and the K_m value for *n*-hexane were taken from a study in rats. The milk compartment changes in volume in response to nursing, milk letdown from nursing is assumed to be a first-order process and milk production a zero-order process. Minimum and maximum volumes for the milk compartment were 0.010 and 0.125 L, respectively. Simulations were run assuming a *n*-hexane air level of 50 ppm using a chemical exposure and nursing schedule over a 24-hour period (4 maternal exposures to *n*-hexane and 8 nursing periods). The amount of *n*-hexane ingested by the infant was predicted.

Validation of the model. Data sets for levels of *n*-hexane in breast milk after quantified exposures to *n*-hexane are not available so the model was not validated.

Target tissues. Target tissues (peripheral nervous system) were not specifically addressed in this model.

Species extrapolation. No species extrapolation was attempted in this model.

Interroute extrapolation. No interroute extrapolation was attempted in this model.

2.4 MECHANISMS OF ACTION

2.4.1 Pharmacokinetic Mechanisms

Absorption. *n*-Hexane is absorbed by passive diffusion in the lungs. Oral and dermal absorption have not been studied, but absorption by these routes is probably by the same process. Alveolar *n*-hexane reaches a steady state with the *n*-hexane in blood; as *n*-hexane is distributed and metabolized in the body more is absorbed from the alveolar air. In studies with humans, there was no evidence of saturation up to

2. HEALTH EFFECTS

204 ppm (Veulemans et al.1982). During exercise in this study, the alveolar uptake rate decreased, but total intake increased slightly because of the higher ventilation rate.

Distribution. The distribution of *n*-hexane is a function of its high lipid and very low water solubility. Partition coefficients established in human tissues indicate a distribution pattern at equilibrium of body fat>>liver, brain, muscle>kidney>heart>lung>blood (Perbellini et al.1985). *n*-Hexane is transported in blood mainly by partitioning into hydrophobic regions of blood proteins (Lam et al.1990). Transfer to tissues occurs via a similar partitioning process. *n*-Hexane can also leave the blood through the lungs via the pulmonary circulation depending on the alveolar air *n*-hexane concentration.

Storage. Experiments in animals indicate that no significant storage in tissues takes place. *n*-Hexane concentrations fell to minimal or nondetectable in all rat tissues, including body fat, within 8 hours after the end of a 6 hour exposure at 1,000 ppm (Bus et al.1981). A PBPK model predicts some accumulation of *n*-hexane in body fat in humans during a workweek, with some still remaining after the weekend (Perbellini et al.1986, 1990a). Whether this release from body fat after exposure ceases is toxicologically significant is unclear.

Excretion. Some *n*-hexane is exhaled following cessation of exposure. This could amount to approximately 10% of that absorbed (Mutti et al.1984; Veulemans et al.1982). Excretion is rapid and biphasic with half-lives of 0.2 hours and 1.7 hours. Most *n*-hexane is excreted in the urine as metabolites. Radiolabeled $^{14}\text{CO}_2$ in exhaled air has been detected after animal exposure to [^{14}C]*n*-hexane (Bus et al. 1982), indicating that intermediary metabolism of some metabolites takes place. 2,5-Hexanedione and 4,5-dihydroxy-2-hexanone are the major urinary metabolites of *n*-hexane in humans. Half-lives of excretion have been estimated to be 13-14 hours (Perbellini et al.1981, 1986).

Effect of Dose and Duration of Exposure on Toxicity. No studies were located where *n*-hexane concentration was measured in workplace air before workers became ill, so no dose-response relationship can be defined for human neurotoxicity as the result of *n*-hexane exposure. Information on duration of exposure leading to toxicity is available from some case series reports. An occupational exposure caused sensory disturbances in the lower extremities after approximately 2 months (Herskowitz et al. 1971). A case of peripheral neuropathy after 7 months of exposure was reported among press-proofing workers in Taipei (Wang et al.1986); a serious case resulting in quadriplegia after 8 months of exposure was reported among sandal workers in Japan (Yamamura 1969). Based on case reports, it can be estimated that

2. HEALTH EFFECTS

workplace exposure to *n*-hexane at or above 500 ppm for several months may result in peripheral neuropathy in some individuals.

The dose-duration relationship to toxicity is clearer in rat studies. Continuous exposure (more than 20 hours a day, 7 days a week) to approximately 500 ppm *n*-hexane results in at least histological signs of peripheral nerve damage in most studies (Altenkirch et al.1982; IRDC 1981; Schaumburg and Spencer 1976) within 7-26 weeks. Intermittent exposure (8 hours a day, 7 days a week) at 700 ppm for 40 weeks produced no effect in rats (Altenkirch et al.1982). In intermittent exposures at higher concentrations, effects were seen at 1,200 ppm after 16 weeks (12 hours a day, 7 days a week) and at 14 weeks at 5,000 ppm (9 hours a day, 5 days a week) (Frontali et al.1981; Huang et al.1989). At the highest concentration/duration exposure reported (5,000 ppm, 16 hours a day, 6 days a week), reduction in motor nerve conduction velocity was observed at 1 week and paralysis was evident by 4 weeks (De Martino et al. 1987).

Route-dependent Toxicity. *n*-Hexane toxicity does not appear to be route-dependent. Peripheral neuropathy can be produced in rats by the oral route (Krasavage et al.1980) at high doses (4,000 mg/kg/day). The clinical and histopathological signs were similar to those seen after inhalation exposure. No reports of neurotoxicity after dermal exposure were located.

2.4.2 Mechanisms of Toxicity

Effects of Metabolism on Toxicity. Neurotoxicity in shoe workers in Japan and Italy was originally linked to glues and solvents containing *n*-hexane (Yamamura 1969). Since *n*-hexane is of low acute toxicity in humans and animals, it was unclear for several years how exposure resulted in toxicity. An outbreak of an almost identical peripheral neuropathy in a plant in Ohio in 1974 (Allen et al.1975) due to the closely related chemical methyl *n*-butyl ketone (2-hexanone) led to the hypothesis that a common metabolite of *n*-hexane and methyl *n*-butyl ketone may be responsible for the observed neurotoxicity. One of these metabolites, 2,5-hexanedione, was found to produce a peripheral neuropathy in rats identical to that produced by the inhalation of *n*-hexane (Schaumburg and Spencer 1976). The time to onset of neurotoxicity with other metabolites depends on the serum levels of 2,5-hexanedione produced, leading to the conclusion that 2,5-hexanedione is the active agent (Krasavage et al.1980). The conversion of *n*-hexane to 2,5-hexanedione takes place in the mixed-function oxidase system of the liver (Toftgard et al. 1983, 1986). There is some evidence in animals that the initial reaction (the conversion of *n*-hexane to

2. HEALTH EFFECTS

2-hexanol) can take place in the lung (Toftgard et al.1986). It appears unlikely that metabolism in humans would be saturated in the expected range of human exposure. In humans, a good correlation has been found between 2,5-hexanedione levels in the urine and workplace concentrations (Perbellini et al.1981).

Target Organ Toxicity. *n*-Hexane exposure is documented to cause toxicity in peripheral nerves of humans (both sensory and motor). In rats, *n*-hexane exposure causes toxicity in the peripheral and central nervous system and in male reproductive tissues. Effects on respiratory tissue have been observed in mice and rabbits. The toxic agent in nervous system and reproductive tissues is believed to be the *n*-hexane metabolite 25-hexanedione (Graham et al.1995).

The sequence of events in *n*-hexane-induced neuropathy has been described in rats (Spencer and Schaumburg 1977a). The process appears to begin by increases in the number of 10 nm axonal neurofilaments and accumulation in swellings on the proximal sides of the nodes of Ranvier in distal regions of large myelinated fibers. As exposure continues, there is a retrograde spread of axonal swellings up the nerve, and smaller myelinated and unmyelinated fibers become involved. The nerve terminal is unaffected until late in the process. The enlarged axons displace the paranodal myelin sheaths, leaving denuded swellings in areas near the nodes of Ranvier. This process occurs before functional impairment is evident and can be reversed on cessation of exposure as swelling diminishes, and proliferation of Schwann cells occurs at these sites with subsequent remyelination of the axons. If exposure to *n*-hexane continues, axonal restoration and remyelination do not take place at some swellings, and the length of the nerve fiber between the swelling and the terminal undergoes breakdown, very similar to that seen when fibers are transected. Axon sprouting is often seen at the intact portion of a degenerated fiber even while intoxication continues. When intoxication ends, this regenerative process can reestablish motor and sensory function.

Peripheral neuropathy begins in the hind limbs in the rat model and eventually affects the front limbs. The nerve fibers most vulnerable to *n*-hexane exposure in rats are the branches of the tibial nerve serving the calf muscles, followed in order by the plantar nerve branches supplying the flexor digitorum brevis muscle, and then sensory plantar nerve branches innervating the digits. As intoxication continues, axonal degeneration ascends the plantar and tibial nerves (Spencer and Schaumburg 1977b). Examination of control animals indicated that the most sensitive fibers were also the largest. Effects on the central nervous system have also been observed in rats exposed to *n*-hexane or its neurotoxic metabolite, 2,5-hexanedione. Axonal swelling and degeneration were observed in the anterior vermis, spinocerebellar tract in the medulla oblongata, and gracile tracts of the spinal cord (Spencer and Schaumburg 1977b).

2. HEALTH EFFECTS

The chemical structure of 2,5-hexanedione suggested that it could react with lysine side-chain amino groups in proteins to form pyrroles (see Figure 2-7). *In vitro* experiments showed that this was, in fact, the case, and that the modified proteins can undergo secondary reactions to yield oxidized and polymeric products (DeCaprio et al.1982; Graham et al.1982). Oral administration of 2,5-hexanedione produced evidence that this process can take place *in vivo* as demonstrated by the detection of 2,5-dimethylpyrrole adducts in serum and axonal cytoskeletal proteins (DeCaprio and O'Neill 1985). When a series of 2,5-hexanedione analogues were tested for their ability to produce neurotoxicity in rats, it was found that only those with the 2,5 gamma spacing were neurotoxic, and that potency correlated with the rate constant for pyrrole formation (St. Clair et al.1988). The role of oxidation of the pyrrole adduct in the development of neurotoxicity was demonstrated with another 2,5-hexanedione analogue which could form pyrroles but was resistant to oxidation. This analogue (3-acetyl-2,5-hexanedione) caused pyrrolidation of protein *in vivo*, but not neurotoxicity.

The reaction of anti-neurofilament antibodies with high molecular weight aggregates from rat neuronal cytoskeletal proteins provided direct evidence for neurofilament cross-linking after 2,5-hexanedione administration (Lapadula et al.1986). Immunoblotting with antibodies specific for phosphorylated forms of cytoskeletal proteins has demonstrated a reduction of phosphorylation in neurofilament proteins and microtubule-associated-protein 2 (MAP-2) after 2,5-hexanedione treatment (Abou-Donia et al.1988).

Whether neurofilament cross-linking is related to the neurofilament accumulation, axonal swellings, and ultimate axonal degeneration observed in *n*-hexane neurotoxicity or is incidental remains to be elucidated (Graham et al.1995). Since the maintenance of the axon depends on transport of cellular components from the neuronal cell body, the effect of 2,5-hexanedione on axonal transport has been investigated. If 2,5-hexanedione treatment slowed or stopped axonal transport, distal axonal degeneration would be an expected consequence. Measurement of the rate of axonal transport both during and after 2,5-hexanedione intoxication showed accelerated rates of transport that persisted after treatment ended (Pyle et al.1993). Increased rates of axonal transport may reflect a reparative response after neuronal injury (Graham et al. 1995).

Figure 2-7. Reaction of 2,5-Hexanedione with Protein

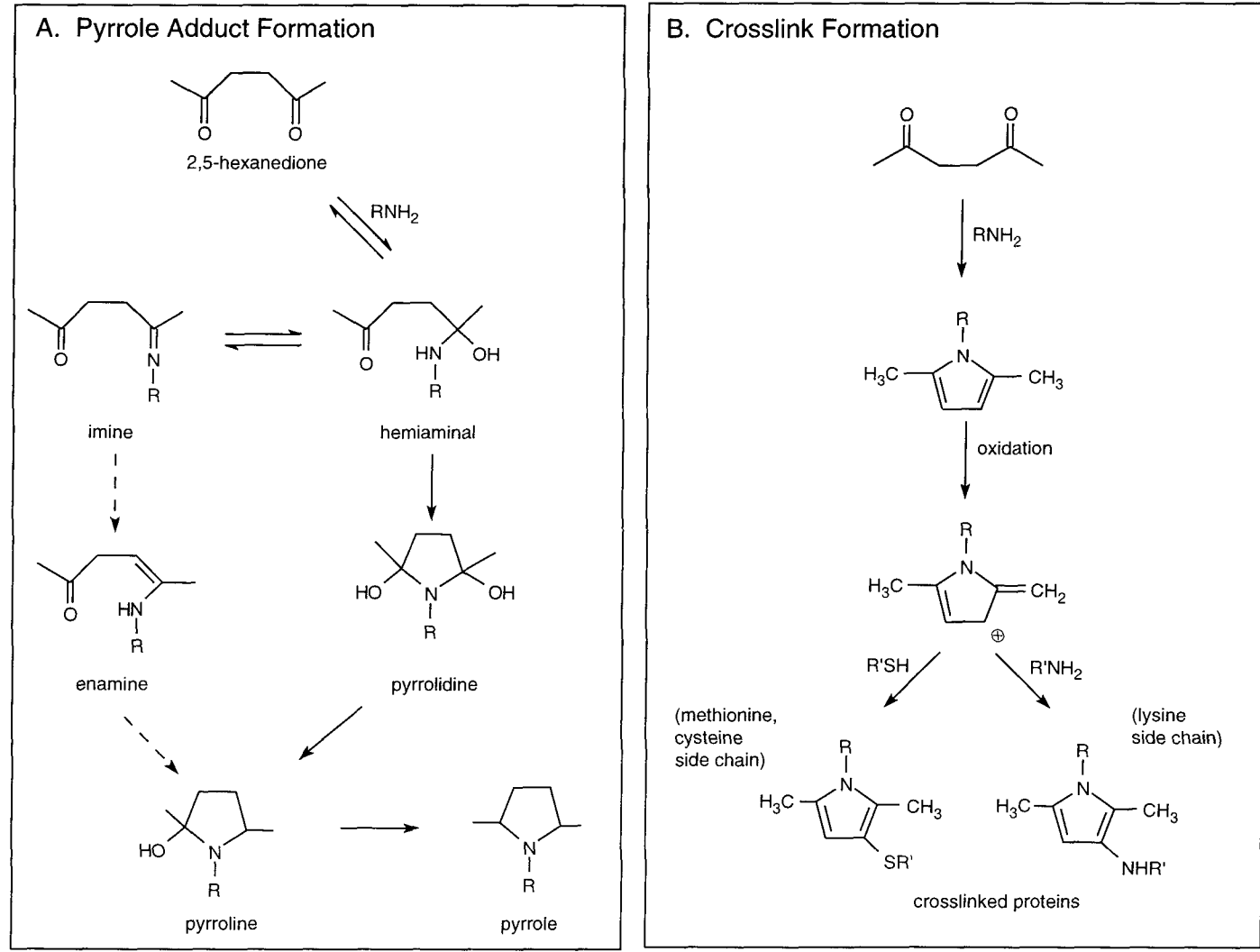

Source: Adapted from Graham et al. 1995

2. HEALTH EFFECTS

No information is available as to whether the mechanism of action of *n*-hexane toxicity in children differs from that of adults. Weanling rats (21 days old) were more resistant to the development of *n*-hexane peripheral neuropathy than young adults (80 days old) during an exposure to 1,000 ppm *n*-hexane (Howd et al. 1983). The authors suggested that the relative resistance of the weanling rats may have been due to shorter, smaller-diameter axons, or to a greater rate of growth and repair in their peripheral nerves compared to those of adults.

2.4.3 Animal-to-Human Extrapolations

The rat is the major model system for human *n*-hexane neurotoxicity. Inhalation of *n*-hexane in this species produces clinical and histopathological effects similar to those seen in workers exposed to *n*-hexane. However, the toxicokinetics in rats are somewhat different (e.g., less 2,5-hexanedione and more 2-hexanol as a proportion of total urinary metabolites compared to humans [Fedtke and Bolt 1987; Frontali et al. 1981]). Mice do not develop clinical signs of neurotoxicity after exposure to *n*-hexane, although histopathological changes (paranodal axonal swellings) have been observed (Dunnick et al. 1989; NTP 1991). A single study in rabbits exposed to high levels of *n*-hexane (3,000 ppm) showed no evidence of neurotoxicity in this species (Lungarella et al. 1984).

2.5 RELEVANCE TO PUBLIC HEALTH

Overview. *n*-Hexane is a hydrocarbon produced from crude oil that is a component of many solvents used in industry. *n*-Hexane is also used in certain special glues and adhesives, and is present in gasoline. Because of the high volatility of *n*-hexane, the most likely route of human exposure is inhalation. The risk of health effects in humans depends on the concentration of *n*-hexane in the air and the duration of exposure. Prolonged occupational exposures (months to years) to high concentrations (± 500 ppm) have resulted in significant human toxicity. Exposure to very high concentrations ($\pm 10,000$ ppm, e.g. as the result of a spill) could result in narcosis, although the major hazard in this case would be the risk of explosion and fire. Narcosis has been observed in animals (Hine and Zuidema 1970) but has not been reported in humans.

Human toxicity associated with *n*-hexane was first recognized in the 1960s and early 1970s in Japan and Italy. Workers in the shoe industries in these countries developed a peripheral neuropathy that started with numbness in the feet and hands, followed by weakness in the lower legs and feet. In severe cases, paralysis

2. HEALTH EFFECTS

developed. Epidemiological investigations revealed that these illnesses were linked with the use of glues and solvents containing high concentrations of *n*-hexane. In all cases, poor ventilation was a major factor in the illness. Removal from the workplace resulted in recovery for the patients over the course of several months to 2 years. There have been hundreds of cases of *n*-hexane neurotoxicity reported from occupational exposure throughout the world, but comparatively few in the United States. This is probably due to different use patterns; in the United States, *n*-hexane is used mainly in closed systems (e.g., for extraction of vegetable oils) while in the shoe industry cases of the 1960s and 1970s, open containers of solvents containing *n*-hexane were present in poorly ventilated workplaces. Issues relevant to children are explicitly discussed in Sections 2.6, Children's Susceptibility, and 5.6, Exposures of Children.

A closely related chemical, 2-hexanone, which is an *n*-hexane metabolite, has also caused peripheral neuropathy in workers (Allen et al. 1975). This chemical is the subject of another publication in this series, *Toxicological Profile for 2-Hexanone* (ATSDR 1991).

n-Hexane is metabolized in the body to a number of metabolites. One of these metabolites, 2,5-hexanedione, is believed to be the ultimate toxic agent in *n*-hexane-induced neurotoxicity. These metabolites are excreted from the body in the urine within a few days of exposure. Experiments in animals show that rats are also susceptible to *n*-hexane neurotoxicity. Mild signs of neurotoxicity can be produced by *n*-hexane exposure in mice and chickens, but these do not progress to severe signs like paralysis, as can occur in humans and rats. Several effects occur in animals at very high concentrations, above the expected range of human exposure to *n*-hexane. *n*-Hexane exposure causes damage to male reproductive tissues in rats and signs of respiratory tract and lung damage in mice and rabbits, respectively. Animal studies have generally not shown adverse developmental effects after inhalation and oral exposure to *n*-hexane.

n-Hexane does not appear to be mutagenic in *in vivo* or *in vitro* test systems, nor does it contain "structural alerts" which have been associated with carcinogenicity (Ashby 1985). No epidemiological studies were located addressing whether there is or is not an association between occupational *n*-hexane exposure and cancer. *n*-Hexane has not been tested for carcinogenicity in animals and has not been categorized as to its potential for carcinogenicity by the International Agency for Research on Cancer (IARC), the National Toxicology Program (NTP), or the EPA. A single report of papillary tumors of the terminal bronchiole epithelium in rabbits after 24 weeks of exposure to 3,000 ppm *n*-hexane was located (Lungarella et al. 1984). In a chronic-duration study in B6C3F₁ mice where exposure was to commercial hexane (51.5% *n*-hexane) for 6 hours/day, 5 days a week for 2 years, a statistically significant treatment-related increase in

2. HEALTH EFFECTS

hepatocellular neoplasms (adenoma and carcinoma) was observed among females exposed at 9,018 ppm (Bio/Dynamics 1995b), but not at 900 or 3,000 ppm. No increases were observed in male mice or in Fischer 344 rats of either sex exposed similarly in a parallel experiment (Bio/Dynamics 1995a).

n-Hexane evaporates very easily so the most likely route of exposure is via inhalation, which is most likely to occur in the workplace. The current U.S. Occupational Safety and Health Administration (OSHA) permissible exposure level (PEL) is 500 ppm for *n*-hexane in workplace air. A new limit of 50 ppm was proposed in 1989, but a U.S. Court of Appeals decision rescinded the 1989 PELs promulgated by OSHA. Only PELs in place prior to 1989 are currently allowed. This decision was based on legal issues and was not specific for *n*-hexane. There is no question that exposure at 500 ppm can cause neurotoxicity in animal models (Spencer et al.1980), and occupational exposure in the range of 500-2,500 ppm resulted in neurotoxicity in 93 of 1,662 workers canvassed in the Japanese shoe industry (Yamamura et al.1969). The American Conference of Governmental Industrial Hygienists (ACGIH) recommends a Threshold Limit Value (TLV) of 50 ppm. Health effects could occur in workplaces if proper industrial hygiene and safety precautions are not followed. Health effects are also possible if consumer products containing *n*-hexane are used without proper ventilation; however, no reports of toxicity after such exposure were located. The exposure of the general population to *n*-hexane is low. Since vegetable oils are extracted with solvents containing *n*-hexane, it is possible that very small amounts are present in these products; these amounts are toxicologically insignificant (see Section 5.4.4). *n*-Hexane has not been detected in drinking water, but it is detectable in the air. The *n*-hexane in the air is at a very low level (ppb) and probably is derived from gasoline. Thus, the risk of adverse health effects in the general population from *n*-hexane exposure appears to be negligible. *n*-Hexane is degraded in the atmosphere in a few days; if present in bodies of water, it evaporates into the atmosphere and is degraded there.

For people living near hazardous waste sites, the potential for adverse health effects would depend on the amount of *n*-hexane to which they were exposed. *n*-Hexane has been detected in at least 60 of the 1,467 hazardous waste sites that have been proposed for inclusion on the EPA National Priority List (NPL) (HazDat 1998). However, the number of sites evaluated for *n*-hexane is not known. The most likely routes of exposure for people living near hazardous waste sites would be by breathing *n*-hexane-contaminated air or skin contact with *n*-hexane-contaminated soil. It is possible, but less likely, to be exposed by drinking contaminated well water. Monitoring of the air, drinking water, and soil levels of *n*-hexane at these sites is necessary to predict the possibility of adverse health effects.

2. HEALTH EFFECTS

Minimal Risk Levels for *n*-Hexane.***Inhalation MRLs***

The database for acute-duration inhalation exposure was insufficient to derive an MRL for this duration. Only one study was identified describing neurological effects for this duration, in which histopathology on nerve tissue was not performed (De Martino et al.1987).

No human studies with adequate documentation of air levels of *n*-hexane were found for intermediateduration inhalation exposure. The animal data were insufficient to derive an MRL for this duration. No NOAELs which were below the LOAELs in the intermediate duration database could be identified for neurological effects, which are the most sensitive.

- An MRL of 0.6 ppm has been derived for chronic-duration inhalation exposure (365 days or more) to *n*-hexane.

The MRL is based on a LOAEL of 58 ppm for reduced motor nerve conduction velocity in occupationally exposed workers (Sanagi et al.1980). This MRL was adjusted by a factor of 10 for use of a LOAEL and a factor of 10 for human variability. Further details are in Appendix A. In this study, where exposure appeared to be limited to only *n*-hexane and acetone, 2 age-matched groups consisting of 14 control workers and 14 exposed workers employed in a factory producing tungsten carbide alloys were compared (Sanagi et al.1980). The groups were matched with respect to age, stature, weight, alcohol consumption, and smoking habits. Exposure was estimated with 22 personal samples taken from the breathing zones over a period of 2 years. This number of samples is fewer than optimal for measuring air levels. Eighthour time-weighted average exposure to solvent vapors consisted of *n*-hexane at 58 ± 41 ppm and acetone at 39 ± 30 ppm; no other solvent vapors were detected. The exposure duration ranged from 1 to 12 years with an average of 6.2 years. Both groups completed questionnaires and underwent clinical neurological examinations with reference to cranial nerves, motor and sensory systems, reflexes, coordination, and gait. Neurophysiological studies performed included electromyography on muscles of the forearm and leg. Nerve stimulation studies were performed with a surface electrode (motor nerve conduction velocity, residual latency). Conduction velocities and distal latencies in the control group were similar to those reported in other studies (Goodgold and Eberstein 1983; Johnson et al.1983). In the questionnaire, the prevalence of headaches, dysesthesia of limbs, and muscle weakness was higher in the exposed group compared to the control; complaints of hearing deficits which were thought to be related to noise from ball

2. HEALTH EFFECTS

mills were also greater in the exposed group. Cranial nerve examinations and motor and sensory nerve examinations did not reveal any statistically significant abnormal neurological signs; however, paresthesia of the extremities was observed in 3 exposed workers and 1 worker in the control group. Differences ($p < 0.05$) in the jump test (muscle strength) and the tuning fork test (vibration sensation) were noted. A general trend of diminished muscle strength reflexes was found in the biceps and knees of exposed workers; however, the difference was not statistically significant. Significant differences in the nerve conduction velocities on the right median, ulnar, and posterior tibial nerves were not found. However, a statistically significant decrease was detected in the posterior tibial nerve and an increased residual latency (time from onset of stimulus to recording) of motor conduction. Residual latency was 2.21 ± 0.34 m/sec in controls versus 2.55 ± 0.48 m/sec in exposed subjects; maximal motor nerve conduction velocity was 48.3 ± 2.1 m/sec in controls versus 46.6 ± 2.3 m/sec in exposed subjects. Normal values for the posterior tibial nerve have been reported as 2.1-5.6 m/sec for distal latency and 44.8-51.2 m/sec for conduction velocity (Goodgold and Eberstein 1983). The subjects in this study were age matched because these parameters vary with increasing age (conduction velocity decreases and distal latency increases). While these changes in the exposed workers remain within the normal range, ATSDR considers these differences in motor nerve conduction velocity and residual latency to be biologically significant.

It is not entirely clear whether the acetone co-exposure in the Sanagi et al. (1980) study contributed to the observed effects. Indirect evidence from an occupational study (Cardona et al. 1996) showed that workplace acetone concentrations had a statistical correlation with the ratio of urinary *n*-hexane metabolites to *n*-hexane air concentration, although it did not correlate with measured urinary metabolites. No animal studies are available describing the effects of inhalation co-exposure to acetone and *n*-hexane, although there are several studies which report interactions between acetone and the neurotoxic metabolite of *n*-hexane 2,5-hexanedione (See Section 2.4, Mechanisms of Action). Oral administration of acetone has been reported to potentiate the neurotoxicity caused by oral exposure to the neurotoxic *n*-hexane metabolite 2,5-hexanedione in rats (Ladefoged et al. 1989, 1994). Oral exposure to acetone alone in rats at 650 mg/kg/day resulted in a statistically significant decrease in motor nerve conduction velocity after 6 weeks; co-exposure to acetone and 2,5-hexanedione resulted in greater effects than those seen with 2,5-hexanedione alone (Ladefoged et al. 1989). It is possible that acetone may potentiate *n*-hexane neurotoxicity by decreasing body clearance of 2,5-hexanedione (Ladefoged and Perbellini 1986). Simultaneous subcutaneous injection of acetone and 2,5-hexanedione increased the peak concentration of 2,5-hexanedione in rat sciatic nerve compared to injection of 2,5-hexanedione alone (Zhao et al. 1998). Acetone also influences the action of many chemicals by its induction of the cytochrome P-450 isozyme

2. HEALTH EFFECTS

CYP2E1 (Patten et al.1986). *n*-Hexane is metabolized by P-450 isozymes; induction by acetone may result in an increased production of the neurotoxic metabolite 2,5-hexanedione.

If the neurotoxicity of *n*-hexane was potentiated in this study by co-exposure to acetone, the level of *n*-hexane alone required to produce these effects would be higher than 58 ppm and the MRL level would be higher. Results from simulations with a PBPK model that accurately predicted *n*-hexane blood and 2,5-hexanedione urine levels (Perbellini et al.1986, 1990a) indicate that at concentrations of 50 ppm, the rate-limiting factor in *n*-hexane metabolism is delivery to the liver, not metabolic activity. This suggests that at this concentration (and at the MRL concentration of 0.6 ppm), induction of P-450 enzymes in the liver by acetone or other chemicals would not affect the rate at which 2,5-hexanedione was produced.

Ambient air concentrations of *n*-hexane are in the low-parts-per-billion range. A recent measurement in Chicago (Moschonas and Glavas 1996) was 2 ppb (0.002 ppm).

Oral MRLs.

The database for oral exposure was insufficient to derive MRLs. Only 3 studies were located regarding neurological effects after oral exposure to *n*-hexane, 2 in rats and 1 in chickens (Abou-Donia et al.1982; Krasavage et al.1980; Ono et al.1981). The Krasavage study (1980) in rats resulted in a NOAEL for neurological effects of 1,140 mg/kg/day, and serious effects were seen at 4,000 mg/kg/day (hindlimb paralysis). However, since little is known about the toxicokinetics of *n*-hexane after oral exposure in either humans or test animals, extrapolation of an animal study to predict health effects in humans was not attempted.

Death. No deaths have been reported in humans after exposure to *n*-hexane by any route. An oral LD₅₀ value of 15,840 mg/kg has been reported in 14-day-old Sprague-Dawley rats, indicating low acute toxicity (Kimura et al.1971). LD₅₀ values were approximately twice as high in adult animals. Deaths have been reported in animals exposed to relatively high concentrations of *n*-hexane via inhalation for intermediate durations. These deaths appear to be the result of difficulty in eating and drinking as *n*-hexane-related paralysis develops. Continuous exposure (24 hours a day) to 1,000-1,500 ppm *n*-hexane resulted in deaths in male Fischer 344 rats within 11 weeks (Howd et al.1983; Rebert and Sorenson 1983). In contrast to the greater susceptibility of 14-day-old rats than adult rats to oral *n*-hexane exposure, inhalation exposure was more likely to cause lethality in older rats than weanlings (Howd et al.1983; Kimura et al.1971).

2. HEALTH EFFECTS

Exposure to 3,040 ppm for 16 weeks (12 hours a day) resulted in the death of 2 of 7 rats with signs of neurotoxicity (Takeuchi et al.1980). Exposure to 3,000 ppm for 24 weeks resulted in the death of 2 of 12 rabbits with signs of respiratory effects (Lungarella et al.1984).

Systemic Effects.

Respiratory Effects. Respiratory effects have not been reported in humans after inhalation exposure to *n*-hexane. *n*-Hexane is not irritating to the eyes, nose, or throat at concentrations up to 500 ppm (Nelson et al.1943). Respiratory effects including rales, gasping, and mouth breathing were reported in rabbits throughout a 24-week inhalation exposure to 3,000 ppm *n*-hexane (Lungarella et al.1984). Histopathological examination revealed serious effects in the lung, including centrilobular emphysema and fibrosis. Respiratory effects were also seen in mice exposed via inhalation to up to 10,000 ppm *n*-hexane for 13 weeks (Dunnick et al.1989; NTP 1991). Mild effects were seen in the olfactory epithelium at 1,000 ppm, and in both the olfactory and respiratory tracts at 10,000 ppm. In another study where rats were exposed by inhalation to 500 ppm *n*-hexane for 6 months, no histological changes were seen in respiratory tissues (IRDC 1981).

The effects observed in animals occurred at high concentrations that are well above the probable range of human exposure. It is unlikely that humans in any setting would be exposed to levels high enough to cause respiratory effects.

Cardiovascular Effects. Cardiovascular effects have not been reported in humans after exposure to *n*-hexane. Information from animal studies is limited to histopathological examination of the heart and aorta after intermediate-duration inhalation studies. No treatment-related lesions were seen in B6C3F₁ mice exposed to *n*-hexane via inhalation at concentrations up to 10,000 ppm for 6 hours a day, 5 days a week for 13 weeks or 1,000 ppm for 22 hours a day, 5 days a week for 13 weeks (Dunnick et al.1989; NTP 1991). Similar results were noted in male Sprague-Dawley rats exposed via inhalation to up to 500 ppm *n*-hexane for 22 hours a day, 7 days a week for 6 months (IRDC 1981).

Subcutaneous administration of *n*-hexane at 143 mg/kg/day for 30 days has been reported to decrease the threshold for ventricular fibrillation in perfused hearts from male Wistar rats (Khedun et al.1996). Myocardial magnesium and potassium levels were reduced in treated rats. When these levels were

2. HEALTH EFFECTS

corrected by supplementation, the ventricular fibrillation potential was still reduced. Histological alterations (disordered myocardial Z-bands) were also observed in exposed rats.

Gastrointestinal Effects. Gastrointestinal effects have not been reported in humans after exposure to *n*-hexane. Information from animal studies is limited to histopathological examination of gastrointestinal tissues after intermediate-duration inhalation studies. Histopathological examination of gastrointestinal tissues revealed no treatment-related lesions in B6C3F₁ mice exposed via inhalation to *n*-hexane at concentrations up to 10,000 ppm for 6 hours a day, 5 days a week for 13 weeks or 1,000 ppm for 22 hours a day, 5 days a week for 13 weeks (Dunnick et al.1989; NTP 1991). Similar results were noted in male Sprague-Dawley rats exposed via inhalation to up to 500 ppm *n*-hexane for 22 hours a day, 7 days a week for 6 months (IRDC 1981).

Hematological Effects. Hematological effects have not been reported in humans after exposure to *n*-hexane. Some minor hematological changes were seen in rats exposed via inhalation to *n*-hexane for 6 months for 6 hours a day, 5 days a week (0, 6, 26, 129 ppm), but were not seen at 21 hours a day, 7 days a week (0,5,27, 126 ppm) and probably have no toxicological significance (Bio/Dynamics 1978). None of the parameters measured in males or females was outside normal biological limits. Hematological parameters were within normal limits in B6C3F₁ mice exposed via inhalation to *n*-hexane at concentrations up to 10,000 ppm for 6 hours a day, 5 days a week for 13 weeks, except for an increase in segmented neutrophils in males exposed to 10,000 ppm. The authors ascribed this to chronic active inflammation in the nasal mucosa of some of the male mice (Dunnick et al.1989; NTP 1991). In mice in this study exposed via inhalation to 1,000 ppm *n*-hexane for 22 hours a day, 5 days a week for 13 weeks, all hematological parameters were within normal limits. No significant changes were observed in hematological parameters or serum chemistry in male New Zealand rabbits exposed via inhalation to 3,000 ppm *n*-hexane for 8 hours a day, 5 days a week for 24 weeks (Lungarella et al.1984).

Musculoskeletal Effects. Muscle wasting and atrophy have been reported in humans occupationally exposed to *n*-hexane (Yamamura 1969). These effects occurred in individuals with severe neurotoxicity. Muscle atrophy is a common finding after intermediate-duration inhalation exposure to *n*-hexane in experimental animals. This atrophy is secondary to *n*-hexane-induced neurotoxicity which results in muscle denervation. Hindlimb atrophy characterized as “severe” was reported in 10 of 11 male Sprague-Dawley rats exposed via inhalation to approximately 1,000 ppm *n*-hexane for 28 or 61 days (Nylen et al. 1989). Mild atrophy of the gastrocnemius muscle was observed in 3 of 10 male Sprague-Dawley rats

2. HEALTH EFFECTS

exposed via inhalation to 502 ppm *n*-hexane for 22 hours a day, 7 days a week for 6 months (IRDC 1981). Degenerative changes in the muscle were not observed. Electron microscopy of the gastrocnemius and soleus muscles in male Wistar rats exposed via inhalation to 3,000 ppm *n*-hexane for 12 hours a day, 7 days a week for 16 weeks revealed denervation, irregular fibers, disordered myofilaments, zig-zagging of the Z-band, and numerous invaginations of the plasma membrane (Takeuchi et al.1980).

Hepatic Effects. Hepatic effects have not been reported in humans after exposure to *n*-hexane.

Histopathological examination of the liver after intermediate-duration inhalation exposure revealed no treatment-related lesions in male Sprague-Dawley rats exposed via inhalation to 500 ppm *n*-hexane daily for 6 months, 22 hours a day (IRDC 1981). Similar results were observed in B6C3F₁ mice exposed via inhalation to *n*-hexane at concentrations up to 10,000 ppm for 6 hours a day, 5 days a week for 13 weeks or 1,000 ppm for 22 hours a day, 5 days a week for 13 weeks (Dunnick et al.1989; NTP 1991).

Decreased blood urea nitrogen (indicating decreased protein catabolism in the liver) has been reported in female, but not male, rats after 26 weeks of inhalation exposure to 126 ppm *n*-hexane for 21 hours a day, 7 days a week (Bio/Dynamics 1978). However, only 4 animals per group were examined in this study, so the toxicological significance of this finding is doubtful.

Endocrine Effects. Endocrine effects have not been reported after *n*-hexane exposure in humans.

Histopathological examination of endocrine tissues (thyroid, parathyroid, adrenals, pituitary, pancreas) after intermediate-duration inhalation exposure revealed no treatment-related lesions in male Sprague-Dawley rats exposed via inhalation to 500 ppm *n*-hexane 22 hours a day for 6 months, (IRDC 1981). Similar results were seen in B6C3F₁ mice exposed via inhalation to *n*-hexane at concentrations up to 10,000 ppm for 6 hours a day, 5 days a week for 13 weeks or 1,000 ppm for 22 hours a day, 5 days a week for 13 weeks (Dunnick et al.1989; NTP 1991). Tissues examined were the thyroid, parathyroid, adrenals, pituitary, and pancreas.

Renal Effects. Renal effects have not been observed in humans following exposure to *n*-hexane.

Histopathological examination of the kidney and urinary bladder showed no treatment-related lesions in B6C3F₁ mice exposed via inhalation to *n*-hexane at concentrations up to 10,000 ppm for 6 hours a day, 5 days a week for 13 weeks or 1,000 ppm for 22 hours a day, 5 days a week for 13 weeks (Dunnick et al. 1989; NTP 1991).

2. HEALTH EFFECTS

An increased incidence and severity of chronic nephropathy (a common age-related condition in male rats) was noted in male Sprague-Dawley rats exposed via inhalation to 500 ppm *n*-hexane daily for 6 months, 22 hours a day (IRDC 1981). Increased kidney weight was also observed. The authors stated that it was unclear whether the increased incidence and severity was due to exacerbation of the process seen in the control group or if the *n*-hexane exposure caused additional tubular injury. No lesions were reported in the urinary bladder. The authors did not investigate what role the unique male rat protein α_{2u} -globulin might be playing in these renal effects. Other substances that apparently bind to this carrier protein include a number of hydrophobic xenobiotics such as petroleum-derived hydrocarbons, including decalin and the gasoline constituent trimethylpentane. These substances cause an α_{2u} -globulin nephropathy syndrome in male rats (EPA 1991). A decrease in urine pH, but no histopathological lesions were reported in male rats exposed via inhalation to 10,000 ppm *n*-hexane for 13 weeks (Cavender et al.1984).

Dermal Effects. Dermal effects have been observed in humans following exposure to *n*-hexane. *n*-Hexane was 1 of 11 solvents tested for dermal toxicity in a male volunteer (Wahlberg 1984). A slight transient erythema was observed after 10-20 minutes exposure to 1.5 mL *n*-hexane and a stinging and/or burning sensation reported by the volunteer. Application of 0.1 mL neat *n*-hexane did not cause clinical signs or affect blood flow.

In animal studies, histopathological examination of the skin after intermediate-duration inhalation exposure revealed no treatment-related lesions in male Sprague-Dawley rats exposed via inhalation to 500 ppm *n*-hexane daily for 6 months, 22 hours a day (IRDC 1981). Similar results were seen in B6C3F₁ mice exposed via inhalation to *n*-hexane at concentrations up to 10,000 ppm for 6 hours a day, 5 days a week for 13 weeks or 1,000 ppm for 22 hours a day, 5 days a week for 13 weeks (Dunnick et al.1989; NTP 1991).

Body Weight Effects. Effects on body weight are common during intermediate-duration exposure of rats to *n*-hexane and tend to occur prior to the development of neurotoxicity (see Section 2.2.1.4). In male Wistar rats exposed via inhalation to 0, 500, 1,200, or 3,000 ppm *n*-hexane daily for 12 hours a day, body weight was lower in the treated groups from 4 weeks of exposure (Huang et al.1989). Significantly decreased grip strength was noted at 13 weeks and at study termination (16 weeks) body weights in the 1,200 and 3,000 ppm groups were 13% less than control. In another study with male Wistar rats exposed via inhalation daily to 3,040 ppm *n*-hexane, reduction in body weight compared to control was significant at 4 weeks and was 33% less than control at 16 weeks (Takeuchi et al.1980). In this study, reductions in nerve conduction velocity were observed at 4 weeks and clinical signs of neurotoxicity at 10 weeks.

2. HEALTH EFFECTS

Similarly, Sprague-Dawley rats exposed via inhalation to 500 ppm showed significant reduction in body weight compared to controls at 7 weeks and clinical signs of neurotoxicity at 16 weeks (IRDC 1981). At study termination after 6 months, treated animals weighed 30% less than controls.

Less severe body weight effects were observed in species that are less susceptible to *n*-hexane-induced neurotoxicity. In male B6C3F₁ mice exposed via inhalation to 1,000 ppm *n*-hexane for 22 hours a day, 5 days a week for 13 weeks, a 10% depression in the final body weight relative to control was observed (Dunnick et al. 1989; NTP 1991). No change was found in females. In male B6C3F₁ mice exposed via inhalation to 10,000 ppm *n*-hexane for 6 hours a day, 5 days a week for 13 weeks, a 17% depression in the final body weight relative to control was observed. NOAELs were 4,000 ppm in males and 10,000 ppm in females (Dunnick et al. 1989; NTP 1991). No effect on body weight was observed in male New Zealand rabbits exposed via inhalation to 3,000 ppm *n*-hexane 8 hours a day, 5 days a week for 24 weeks (Lungarella et al. 1984). Variable weight loss was observed in Leghorn chickens exposed via inhalation to 1,000 ppm *n*-hexane continuously for 30 days (2%) and 90 days (12%) (Abou-Donia et al. 1991). Weight loss was greatly exacerbated in the 90-day study (up to 35%) when chickens were co-exposed via inhalation to 1,000 ppm *n*-hexane and 1,000 ppm methyl isobutyl ketone.

Metabolic Effects. Metabolic effects have not been reported in humans after exposure to *n*-hexane. In animal studies where metabolic parameters (blood pH, electrolytes, glucose) were measured, no effects were seen after inhalation exposure to *n*-hexane in rats at up to 10,000 ppm for 6 hours a day, 5 days a week for 13 weeks (Cavender et al. 1984) or in B6C3F₁ mice similarly exposed (Dunnick et al. 1989; NTP 1991). Higher mean-fasting glucose was observed in male Sprague-Dawley rats exposed for 6 hours a day, 5 days a week at 6 and 129 ppm, but not at 26 ppm (Bio/Dynamics 1978). Female fasting glucose levels were unaffected by exposure in this study. No effect on this parameter was seen in a parallel experiment at similar concentrations for 21 hours a day, so this finding is of doubtful toxicological significance, especially since only 4 animals per group were examined in this study. Body temperature was unaffected in rats by continuous exposure to up to 1,500 ppm *n*-hexane at 2 and 11 weeks (Rebert and Sorenson 1983).

Immunological and Lymphoreticular Effects. One report of immunological effects in humans after exposure to *n*-hexane was located (Karakaya et al. 1996) describing a reduction in immunoglobulin levels in a group of 35 workers compared to a control group of 23. The reductions correlated with 2,5-hexanedione in urine but not with workplace *n*-hexane concentrations (23-215 ppm). The reductions

2. HEALTH EFFECTS

also remained well within the normal ranges for immunoglobulins in blood, so the toxicological significance of these findings cannot be assessed without confirmatory studies (Jackson et al.1997). Cell counts (lymphocytes, neutrophils, monocytes, eosinophils) were unaffected by *n*-hexane exposure. No reports on dermal sensitization after exposure to *n*-hexane in humans were located in the literature. The animal database is limited to intermediate-duration inhalation studies where tissues were examined histopathologically (e.g, lymph nodes, thymus, bone marrow, spleen), no adverse effects were seen (Cavender et al.1984; Dunnick et al.1989; IRDC 1981; NTP 1991).

Neurological Effects. The major public health concern regarding *n*-hexane exposure is the potential for the development of neurotoxicity. Occupational studies have documented that human exposure to *n*-hexane can result in a peripheral neuropathy that in severe cases can lead to paralysis (Altenkirch et al. 1977; Yamamura 1969; Wang et al.1986). The dose-duration relationship has not been well characterized in humans, but concentrations of 500 ppm and above, and exposure for 2 months or more have been associated with human neurotoxicity. Brief exposure to extremely high concentrations of *n*-hexane may cause signs of narcosis in humans; prostration and coma have been observed in animals exposed to a mixture of hexanes at concentrations of 70,000-80,000 ppm (Hine and Zuidema 1970). At these levels, however, explosion and fire would be the main concern.

ATSDR has developed a chronic-duration inhalation MRL based on neurological effects in humans; the study on which this MRL is based is discussed earlier in this section.

A case series of workers in a furniture factory in the Bronx, New York, illustrates the typical clinical presentation of *n*-hexane neurotoxicity (Herskowitz et al.1971). This report describes the cases of 3 women who worked as cabinet finishers and whose job was to wipe glue off furniture with rags soaked in a solvent which contained *n*-hexane. An open drum of this solvent was used in a small, poorly ventilated room. Air measurements of *n*-hexane averaged 650 ppm, although peaks of up to 1,300 ppm also occurred. Neurological signs of both motor and sensory impairment were noted in all 3 women with an onset 24 months after beginning employment. Initial symptoms and clinical findings were similar in all three women. In the first case (a 23-year-old woman), initial symptoms were a burning sensation in the face, numbness of the distal extremities, and an insidious, progressive distal symmetrical weakness in all extremities. Frequent headaches and abdominal cramps were also reported. After being admitted to the hospital (6 months after beginning work), muscle testing revealed a moderate distal symmetrical weakness and a bilateral foot-drop gait. There was a moderate decrease of pin and touch perception and mild

2. HEALTH EFFECTS

impairment of vibration and position sense in the lower extremities. Tendon reflexes were slightly hyperreflexic (1+) and symmetrical throughout except for absent Achilles tendon reflexes. No Babinski sign was present. Serum lead screening was negative. An electromyogram revealed fibrillation potentials in the small muscles of the hands and feet. Nerve conduction velocities were 45 m/sec in the left ulnar nerve (normal range in the general population, 49-75), 26 m/sec in the right median nerve (normal range, 50-75), and 23 m/sec in the left peroneal nerve (normal range, 40-60). Sural nerve biopsy was unremarkable, although electron microscopic examination showed a few myelinated axons containing dense bodies and exceptionally numerous mitochondria. Muscle biopsy showed scattered groups of small angulated fibers and many fibers with clear central zones, consistent with denervation. Electron microscopy of nerve branches within the muscle showed an increased number of neurofilaments with abnormal membranous structures and clumping and degeneration of mitochondria with dense bodies. Increased numbers of mitochondria, glycogen granules, and degenerated mitochondria were noted in the motor endplates.

Recovery from *n*-hexane peripheral neuropathy has been examined. In a follow-up study, a group of 90 shoe manufacturing workers (27 men and 63 women) diagnosed in the past with *n*-hexane peripheral neuropathy were studied again at least one year after cessation of *n*-hexane exposure (Valentino et al. 1996). Subjects were referred by the Italian government to confirm disability status and thus may not be representative of all those originally diagnosed. Subjects were classified on the basis of the duration of time since the diagnosis. Motor nerve conduction velocities and distal latencies had improved from those observed at the time of diagnosis and were similar to a control group. However, sensory nerve conduction velocities and distal latencies, while improved from those at diagnosis, were still statistically different from controls.

Peripheral neuropathy has also occurred in humans as the result of solvent abuse of products containing *n*-hexane (Altenkirch et al. 1977; Chang et al. 1998; Spencer et al. 1980). Clinical signs were very similar to those seen after occupational exposure; however, signs of central nervous system toxicity may also be present due to other components in the inhaled mixtures, e.g., toluene (Spencer et al. 1980).

Several studies have demonstrated sub-clinical alteration in neurological function in humans after inhalation exposure to *n*-hexane. In a cross-sectional study using age-matched controls, workers in a shoe factory exposed via inhalation to *n*-hexane were compared to a control group, which had not been exposed, from the same factory (Mutti et al. 1982a). Mean breathing-zone *n*-hexane air concentrations were 69 ppm

2. HEALTH EFFECTS

in the mild-exposure group and 134 ppm in the high-exposure group. Methyl ethyl ketone, which has been reported to potentiate *n*-hexane neurotoxicity in humans and animals (Altenkirch et al.1977, 1982), was present at 22 ppm in the mild exposure group and 76 ppm in the high exposure group. Cyclohexane and ethyl acetate were also detected. Symptoms more frequent during the workday in the exposed than the control group were sleepiness and dizziness. Chronic symptoms more frequent in the exposed group were weakness, paraesthesia, and hypoesthesia. Motor action potential amplitude in all three examined nerves was significantly decreased compared to controls in both exposed groups. Motor nerve conduction velocity was significantly decreased in median and peroneal nerves, but not in the ulnar nerve. In the median nerve, motor nerve conduction velocity was significantly decreased in the high-exposure group compared to the mild-exposure group.

A group of 15 women from a shoe factory (mean age 26.6 years, mean exposure time 4.5 years) was compared to a control group of 15 healthy age-matched women from other shoe factories who had not been exposed to neurotoxic chemicals (Mutti et al.1982b). The mean *n*-hexane air concentration was 195 ppm for 36 samples taken over a 3-year period in the factory. Methyl ethyl ketone was present at 60 ppm. All nerve conduction velocities (motor and sensory) were significantly slowed in exposed workers compared to controls. Sensory nerve action potential peak latency was significantly slower in the median and ulnar nerves of the exposed workers. The somatosensory-evoked potential recording could be broken down into 10 peaks; significantly greater latency was observed for the first 2 peaks in the exposed group compared to the controls. There was a negative linear relationship between distal sensory conduction velocity and latency of the earliest evoked potential (P15).

Clinical signs of peripheral neuropathy similar to those seen in human occupational exposures to *n*-hexane can be produced in rats via the inhalation and oral routes, but not in other test species (Altenkirch et al. 1982; De Martino et al.1987; Dunnick et al.1989; Frontali et al.1981; Huang et al.1989; IRDC 1981; Krasavage et al.1980; NTP 1991; Schaumburg and Spencer 1976; Takeuchi et al.1980). Paranodal axonal swelling in mice (Dunnick et al.1989; NTP 1991) and leg weakness in chickens (Abou-Donia et al. 1985) can be produced with inhalation exposure to *n*-hexane, but these conditions do not progress to the severe neurotoxicity observed in humans and rats. The molecular mechanism responsible for the axonal swelling, demyelination, and axonal degeneration seen in human *n*-hexane neurotoxicity is currently unknown. However, animal experiments provide strong evidence that the mechanism involves the formation of protein adducts (pyrrolidation) by the neurotoxic metabolite 2,5-hexanedione (Graham et al. 1995) and possibly crosslinking of neuronal cytoskeletal proteins (e.g., neurofilaments).

2. HEALTH EFFECTS

Neurological effects have been observed in many intermediate-duration inhalation experiments in rats. In Sprague-Dawley rats exposed continuously to 400-600 ppm *n*-hexane for up to 162 days, animals developed an unsteady, waddling gait after 45-69 days of exposure (Schaumburg and Spencer 1976). Further exposure resulted in a progressive, symmetrical, distal hindlimb weakness with foot-drop. Severely affected animals also developed distal weakness of the upper extremities. Pathological changes including giant axonal swellings and fiber degeneration were detected in the peripheral and central nervous systems of the 4 animals exposed for 49 days. Electron microscopic examination showed the swollen regions contained densely packed masses of 10 nm neurofilaments. Groups of mitochondria and neurotubules were displaced to the periphery of the axon or segregated into bundles.

The sequence of events in *n*-hexane-induced neuropathy has been described in rats (Spencer and Schaumburg 1977a). The process appears to begin by increases in the number of 10 nm axonal neurofilaments and accumulation in swellings on the proximal sides of the nodes of Ranvier in distal regions of large myelinated fibers. As exposure continues, there is a retrograde spread of axonal swellings up the nerve and smaller myelinated and unmyelinated fibers become involved. The nerve terminal is unaffected until late in the process. The enlarged axons displace the paranodal myelin sheaths leaving denuded swellings in areas near the nodes of Ranvier. This process occurs before functional impairment is evident and can be reversed as swelling diminishes, and Schwann cells appear at these sites and remyelinate the axon. As exposure to *n*-hexane continues, axonal restoration and remyelination do not take place at some swellings, and the length of the nerve fiber between the swelling and the terminal undergoes breakdown, very similar to that seen when fibers are transected. Axon sprouting is often seen at the intact portion of a degenerated fiber even while intoxication continues. When intoxication ends, this regenerative process can reestablish motor and sensory function.

The nerve fibers most vulnerable to *n*-hexane exposure in rats were the branches of the tibial nerve serving the calf muscles of the hind limbs, followed in order by the plantar nerve branches supplying the flexor digitorum brevis muscle, and then sensory plantar nerve branches innervating the digits. As intoxication continued, axonal degeneration ascended the plantar and tibial nerves (Spencer and Schaumburg 1977b). Examination of control animals indicated that the most sensitive fibers were also the largest.

Effects on the central nervous system have also been observed in rats exposed to either *n*-hexane or its neurotoxic metabolite, 2,5-hexanedione. Axonal swelling and degeneration were observed in the anterior vermis, spinocerebellar tract in the medulla oblongata, and gracile tracts of the spinal cord after inhalation

2. HEALTH EFFECTS

exposure to *n*-hexane or drinking water exposure to 2,5-hexanedione (Spencer and Schaumburg 1977b). Axonal swellings were also observed in the gracile tract of the spinal cord at cervical levels in rats exposed to 700 ppm *n*-hexane (Altenkirch et al.1982). In both of these cases, severe peripheral neuropathy and axonal demyelination and/or degeneration were present. In other rat studies where central nervous system tissues were examined (brain, spinal cord), no changes were noted in a continuous exposure at 500 ppm for 6 months where gait disturbances developed (IRDC 1981) or in a 13-week exposure at up to 10,000 ppm for 6 hours a day where no clinical signs of neuropathy were observed (Cavender et al.1984). Mild atrophy (IRDC 1981) and axonal swelling (Cavender et al.1984) in peripheral nerve were observed in these studies. One of 15 male, but none of 15 female, rats exposed to 10,000 ppm in the Cavender (1984) study exhibited axonal swelling in the medulla. Evoked responses recorded in the brain (somatosensory, brainstem auditory, cortical auditory) exhibited increased latencies and decreased amplitude in rats exposed to 1,000 or 1,500 ppm *n*-hexane (Rebert and Sorenson 1983). Signs of peripheral neuropathy (reduced hindlimb grip strength) were also present. It appears that while central nervous system effects can be produced by *n*-hexane exposure in rats, the peripheral nervous system is more sensitive. It should also be noted that age-related changes in the central nervous system include axonal swelling and may resemble the early stages of *n*-hexane neurotoxicity (Bio/Dynamics 1978).

Neurological examinations of humans with *n*-hexane-induced peripheral neuropathy have not shown clinical signs of central nervous system toxicity (Herskowitz et al.1971; Yamamura 1969). There have been reports of altered evoked potentials recorded in the brain (increased latency, decreased amplitude) in humans occupationally exposed to *n*-hexane (Mutti et al.1982c; Seppalainen et al.1979). There has been one report of an individual occupationally exposed to *n*-hexane for 38 years who developed Parkinsonism (Pezzoli et al.1995), although the etiology of this case is complicated by the fact that the patient had a sister who was probably affected by Parkinsonism. Further studies, particularly prospective follow-up studies of exposed workers, are necessary before any conclusions can be drawn as to whether exposure to *n*-hexane causes central nervous system effects in humans.

Neurological effects are possible in humans exposed to *n*-hexane. For individuals living near hazardous waste sites, information on the air concentration of *n*-hexane would be necessary to predict the possibility of health effects.

Reproductive Effects. Reproductive effects have not been examined in humans after exposure to *n*-hexane. A dominant-lethal test in mice showed no effect on male fertility (Litton Bionetics 1980). No

2. HEALTH EFFECTS

effects were seen on reproductive tissues in male rats after intermediate-duration inhalation exposure at 500 ppm (IRDC 1981) or in either sex of mice after intermediate-duration inhalation exposure to up to 10,000 ppm *n*-hexane (Dunnick et al.1989; NTP 1991). However, inhalation exposure in male rats to higher concentrations of *n*-hexane showed effects after acute-duration exposure to 5,000 ppm (spermatid and spermatocyte degeneration and exfoliation) and atrophy of testicular germinal epithelium after intermediate-duration exposure to 1,000 ppm (De Martino et al.1987; Nylen et al.1989). Testicular atrophy in rats was also noted after intermediate-duration oral exposure at 4,000 mg/kg/day (Krasavage et al.1980). Similar to *n*-hexane neurotoxicity after inhalation exposure, effects on the testes in rats can be reproduced by oral administration of the *n*-hexane metabolite 2,5-hexanedione (Chapin et al.1982; Gillies et al.1981). It is currently unknown if similar effects might occur in humans exposed to *n*-hexane. These effects in animal experiments are always accompanied by severe neurotoxicity.

Developmental Effects. Developmental effects have not been examined in humans after exposure to *n*-hexane. Developmental effects were not observed in most acute-duration inhalation animal studies with *n*-hexane except for a temporary decrease in pup weight gain in offspring from pregnant rats exposed via inhalation to 1,000 ppm during gestation days 8-16 (Bus et al.1979), and a decrease in live fetuses per litter and female fetus weight in the offspring of pregnant mice exposed at 5,000 ppm (Mast et al.1988). No effects on offspring were seen in pregnant rats exposed via inhalation to 409 ppm *n*-hexane during gestation days 6-15 (Litton Bionetics 1979). Similar results were seen when pregnant mice were orally exposed to up to 2,830 mg/kg/day *n*-hexane during gestation days 6-1.5 (Marks et al.1980). Reduced fetal weight was seen in this study at 7,920 mg/kg/day; however, maternal toxicity was seen at this dose, so the effect may have been non-specific rather than developmental. Teratogenic effects have not been observed in any animal studies. Based on limited information, developmental effects do not seem likely in humans exposed to *n*-hexane.

Genotoxic Effects. Genotoxic effects have not been examined in humans after *n*-hexane exposure. The database on the genotoxicity potential of *n*-hexane is limited (see Tables 2-6 and 2-7). *n*-Hexane was negative in a dominant lethal test in mice by the inhalation route at up to 396 ppm *n*-hexane (Litton Bionetics 1980). Similar results were observed in another dominant lethal mutation study at higher concentrations in which male Swiss mice were exposed to up to 5,000 ppm *n*-hexane for 20 hours a day for 5 days (Mast et al.1989b). In an inhalation study, morphological alterations in sperm were noted in rats in at 5,000 ppm *n*-hexane (De Martino et al.1987). In contrast, sperm abnormalities were not observed in B6C3F₁ mice exposed to up to 5,000 ppm *n*-hexane for 20 hours a day for 5 days (Mast et al.

Table 2-6. *n*-Hexane Genotoxicity *In Vivo*

Species (test system)	End point	Results	Reference
Rat	Sperm morphology	+	De Martino et al. 1987
Mouse (bone marrow)	Sister chromatid exchange	-	NTP 1991
Mouse	Dominant lethal mutation	-	Litton Bionetics 1980
Mouse	Chromosomal exchanges	-	NTP 1991
Mouse	Micronuclei formation	-	NTP 1991
Mouse	Sperm morphology	-	Mast et al. 1989a
Mouse	Dominant lethal mutation	-	Mast et al. 1989b

+ = positive; - = negative

Table 2-7. *n*-Hexane Genotoxicity *In Vitro*

Test system	End point	Results		Reference
		With activation	Without activation	
Non-mammalian cells				
<i>Escherichia coli</i>				
WP2		—	—	McCarroll et al. 1981a
WP2 uvr A		—	—	McCarroll et al. 1981a
CM611		—	—	McCarroll et al. 1981a
WP67		—	—	McCarroll et al. 1981a
WP100		—	—	McCarroll et al. 1981a
WP110		—	—	McCarroll et al. 1981a
p3478		—	—	McCarroll et al. 1981a
<i>Bacillus subtilis</i>				
H17		—	—	McCarroll et al. 1981b
M45		—	—	McCarroll et al. 1981b
<i>Salmonella typhimurium</i>				
TA98	Reverse mutation	—	—	Mortelmans et al. 1986
TA100		—	—	Mortelmans et al. 1986
TA1535		—	—	Mortelmans et al. 1986
TA1537		—	—	Mortelmans et al. 1986
TA92	Reverse mutation	—	—	Ishidate et al. 1984
TA94		—	—	Ishidate et al. 1984
TA98		—	—	Ishidate et al. 1984
TA100		—	—	Ishidate et al. 1984
TA1535		—	—	Ishidate et al. 1984
TA1537		—	—	Ishidate et al. 1984
TA98	Reverse mutation	—	—	Houk et al. 1989
TA100		—	—	Houk et al. 1989
TA 98	Reverse mutation	—	—	NTP 1991
TA 100		—	—	NTP 1991
TA 1535		—	—	NTP 1991
TA 1537		—	—	NTP 1991

Table 2-7. *n*-Hexane Genotoxicity *In Vitro* (continued)

Test system	End point	Results		Reference
		With activation	Without activation	
<i>Saccharomyces cerevisiae</i>	Chromosome loss	-	-	Mayer and Goin 1994
Mammalian cells				
Human (lymphocytes)	Unscheduled DNA synthesis	-	-	Perocco et al. 1983
Hamster (CHO)	Chromosomal aberrations	-	-	NTP 1991
Hamster (CHO)	Sister chromatid exchanges	-	-	NTP 1991
Hamster (Chinese CHL)	Polyploidy	ND	+	Ishidate et al. 1984

- = negative; + = positive; ND = not detectable

2. HEALTH EFFECTS

1989a). Analysis of sperm obtained 5 weeks post-exposure showed no significant effects on morphology compared to the control group. There was no increase in the incidence of micronucleated normochromatic erythrocytes or polychromatic erythrocytes in the peripheral blood of male and female mice exposed via inhalation to 1,000, 4,000, or 10,000 ppm *n*-hexane, 6 hours a day, 5 days a week for 13 weeks or in mice exposed to 1,000 ppm for 22 hours a day for 13 weeks (NTP 1991). In an *in vivo* mouse bone marrow cytogenetics assay, doses of 500, 1,000, or 2,000 mg/kg *n*-hexane dissolved in corn oil and administered by intraperitoneal injection did not increase the incidence of sister chromatid exchanges; chromosomal aberrations were slightly increased, but this increase was not significant (NTP 1991). Results have generally been negative for *n*-hexane in bacterial tester strains such as *Escherichia coli*, *Bacillus subtilis*, and *Salmonella typhimurium* both with and without metabolic activation (Houk et al.1989; Ishidate et al. 1984; McCarroll et al.1981 a, 1981 b; Mortelmans et al.1986). In studies conducted by the National Toxicology Program (NTP 1991), *n*-hexane was not mutagenic in *S. typhimurium* strains TA98, TA100, TA1535, or TA1537 when tested with a preincubation protocol at doses up to 1,000 µg/plate with or without Aroclor 1254-induced male Sprague-Dawley rat or Syrian hamster liver S9 fraction. *n*-Hexane was also negative in an *in vitro* test for induction of chromosome loss in *S. cerevisiae* (Mayer and Goin 1994).

Negative results were also obtained in mammalian cells except for one observation of polyploidy in Chinese hamster CHL cells (Ishidate et al.1984; Perocco et al.1983). Treatment at doses up to 5,000 µg/mL in the presence or absence of Aroclor 1254-induced male Sprague-Dawley rat liver S9 did not induce chromosomal aberrations in cultured Chinese hamster ovary (CHO) cells. Sister chromatid exchanges were induced in CHO cells but only in the presence of S9; no dose-response was apparent (NTP 1991).

The *n*-hexane metabolite 2,5-hexanedione was strongly positive in an *in vitro* test for induction of chromosome loss in *S. cerevisiae* (Mayer and Goin 1994). It was suggested that this effect was due to an effect of 2,5-hexanedione on microtubule function in the yeast cells, resulting in faulty segregation of chromosomes.

Cancer. There is currently little information on the carcinogenic potential of *n*-hexane. No epidemiological studies were located addressing whether there is or is not an association between occupational *n*-hexane exposure and cancer. In a chronic-duration study in B6C3F₁ mice (50/sex/group) with exposure to commercial hexane (51.5% *n*-hexane) for 6 hours/day, 5 days a week for 2 years, a statistically significant treatment-related increase in hepatocellular neoplasms (adenoma and carcinoma)

2. HEALTH EFFECTS

was observed among females exposed at 9,018 ppm (Bio/Dynamics 1995b). Incidences of adenoma were: 4/50, 6/50, 4/50, and 10/50 at 0, 900, 3,000, and 9,018 ppm, respectively. Incidences of carcinoma at these exposures were 3/50, 2/50, 5/50, and 6/50, and incidences of total neoplasms were 7/50, 8/50, 9/50, and 16/50. In males, liver tumors were observed but were not treatment-related. In the 9,018 ppm group of females, liver tumor incidence was similar to control males. A significant treatment-related decrease in severity of cystic endometrial hyperplasia of the uterus was also observed among females in the 9,018 ppm group. The authors suggested that the decrease in severity of cystic endometrial hyperplasia may indicate a possible treatment-related alteration in the hormonal balance (e.g., a decrease in estrogenic stimulation of the uterus), resulting in the female mice showing the normal incidence of male liver neoplasms. It is not clear what components of the hexane mixture caused the neoplasms. A parallel experiment carried out on rats showed no increase in incidence of neoplasms at any site (Bio/Dynamics 1995a). Papillary tumors have been reported in the bronchiolar epithelium of rabbits after a 24-week exposure to 3,000 ppm *n*-hexane in a study designed to assess respiratory effects (Lungarella et al. 1984). *n*-Hexane does not contain any structural alerts associated with carcinogenicity (Ashby 1985) and, as mentioned above, has not been found to be mutagenic. *n*-Hexane has not been categorized as to its carcinogenic potential by the IARC, EPA, or DHHS.

Toxicity of *m*Hexane Metabolites. Since *n*-hexane is metabolized in the body, exposure also occurs to metabolites. The neurotoxicity of *n*-hexane is believed to ultimately result from the effects of one of these metabolites, 2,5-hexanedione, on peripheral nerves (see Section 2.4, Mechanisms of Action). One potential metabolite, 2-hexanone, has also caused neurotoxicity in humans (Allen et al. 1975). The other metabolites of *n*-hexane (see Figure 2-3) can also produce neurotoxicity in rats via their subsequent metabolism to 2,5-hexanedione (Krasavage et al. 1980). No information was located regarding other mechanisms of toxicity for these metabolites.

2,5-Hexanedione causes a peripheral neuropathy in rats virtually identical to that caused by inhalation of *n*-hexane when administered in drinking water at a concentration of 0.5% (Schaumburg and Spencer 1975; Spencer and Schaumburg 1977a, 1977b). The time to onset of peripheral neuropathy was about 12 weeks. No significant differences in histopathology of peripheral or central nerves were noted between oral exposure to 2,5-hexanedione and inhalation exposure to *n*-hexane.

2,5-hexanedione can also affect testicular tissue in male rats and is, in fact, used as a model for chemically induced sterility (Chapin et al. 1982; Krasavage et al. 1980). Exposure to drinking water containing 1%

2. HEALTH EFFECTS

2,5-hexanedione results in severe seminiferous epithelial degeneration and loss of germ cells. In a group of rats receiving a single dose of 2,000 mg/kg 2,5-hexanedione (Linder et al.1992), no histopathological changes were detected 2 days after treatment; however, at 14 days, testicular debris was observed in the proximal caput, sloughed epididymal cells were observed in the cauda lumen as was retention at the lumen and base of Step 19 spermatids in Stages IX-XII.

2.6 CHILDREN'S SUSCEPTIBILITY

This section discusses potential health effects from exposures during the period from conception to maturity at 18 years of age in humans, when all biological systems will have fully developed. Potential effects on offspring resulting from exposures of parental germ cells are considered, as well as any indirect effects on the fetus and neonate due to maternal exposure during gestation and lactation. Relevant animal and *in vitro* models are also discussed.

Children are not small adults. They differ from adults in their exposures and may differ in their susceptibility to hazardous chemicals. Children's unique physiology and behavior can influence the extent of their exposure. Exposures of children are discussed in Section 5.6, Exposures of Children.

Children sometimes differ from adults in their susceptibility to hazardous chemicals, but whether there is a difference depends on the chemical (Guzelian et al.1992; NRC 1993). Children may be more or less susceptible than adults to health effects, and the relationship may change with developmental age (Guzelian et al.1992; NRC 1993). Vulnerability often depends on developmental stage. There are critical periods of structural and functional development during both pre-natal and post-natal life and a particular structure or function will be most sensitive to disruption during its critical period(s). Damage may not be evident until a later stage of development. There are often differences in pharmacokinetics and metabolism between children and adults. For example, absorption may be different in neonates because of the immaturity of their gastrointestinal tract and their larger skin surface area in proportion to body weight (Morselli et al. 1980; NRC 1993); the gastrointestinal absorption of lead is greatest in infants and young children (Ziegler et al.1978). Distribution of xenobiotics may be different; for example, infants have a larger proportion of their bodies as extracellular water and their brains and livers are proportionately larger (Altman and Dittmer 1974; Fomon 1966; Fomon et al.1982; Owen and Brozek 1966; Widdowson and Dickerson 1964). The infant also has an immature blood-brain barrier (Adinolfi 1985; Johanson 1980) and probably an immature blood-testis barrier (Setchell and Waites 1975). Many xenobiotic metabolizing enzymes have

2. HEALTH EFFECTS

distinctive developmental patterns and at various stages of growth and development, levels of particular enzymes may be higher or lower than those of adults and sometimes unique enzymes may exist at particular developmental stages (Komori 1990; Leeder and Kearns 1997; NRC 1993; Vieira et al.1996). Whether differences in xenobiotic metabolism make the child more or less susceptible also depends on whether the relevant enzymes are involved in activation of the parent compound to its toxic form or in detoxification. There may also be differences in excretion, particularly in the newborn who has a low glomerular filtration rate and has not developed efficient tubular secretion and resorption capacities (Altman and Dittmer 1974; NRC 1993; West et al.1948). Children and adults may differ in their capacity to repair damage from chemical insults. Children also have a longer lifetime in which to express damage from chemicals; this potential is particularly relevant to cancer.

Certain characteristics of the developing human may increase exposure or susceptibility while others may decrease susceptibility to the same chemical. For example, the fact that infants breathe more air per kilogram of body weight than adults may be somewhat counterbalanced by their alveoli being less developed, so there is a disproportionately smaller surface area for absorption (NRC 1993).

Cases of *n*-hexane toxicity in humans have occurred as the result of workplace exposure and solvent abuse (Spencer et al.1980). Some of these cases of peripheral neuropathy have occurred in teenagers (particularly with solvent abuse); however, none of the clinical reports indicate differences in physical signs or functional tests between this group and adults (Altenkirch et al.1977; Yamamura et al.1969). While no reports of *n*-hexane toxicity in young children were located, it is probable that similar toxicity would occur if exposure was comparable to that in affected adults. Specific information is not available on whether children are more susceptible than adults to the effects of *n*-hexane.

Animal studies provide limited further information. Only 2 studies were located where the responses to *n*-hexane were compared between young animals and adults. In a study in rats directly comparing the effects of *n*-hexane exposure in weanlings (21 days old) and young adults (80 days old) (Howd et al.1983), peripheral neuropathy occurred in both groups, although onset was more rapid in the young adult group. No deaths were observed over the 11-week exposure period and 3-week recovery period in weanling rats. In young adults, however, 5 of 10 rats died as the result of severe neuropathy. The authors suggested that the relative resistance of the weanling rats may have been due to shorter, smaller-diameter axons, or to a greater rate of growth and repair in their peripheral nerves compared to those of adults. An oral LD₅₀ study showed 14-day-old rats were more susceptible to the acute effects of a large dose of *n*-hexane than young

2. HEALTH EFFECTS

adults (Kimura et al.1970). LD₅₀ values for *n*-hexane were 15,840 mg/kg for 14 day olds and 32,340 mg/kg for the young adults. Clinical signs and time to death were not reported.

n-Hexane has not caused teratogenic effects in rodent models (Bus et al.1979; Litton Bionetics 1979; Marks et al.1980; Mast et al.1987; Mast et al.1988), although some developmental effects have been reported in mice (decreased live fetuses per litter, female fetus weight, gravid uterine weight) exposed during pregnancy to 5,000 ppm (Mast et al.1988). Observation of the offspring after birth to maturity was not performed. There is one report of delayed histogenesis of the cerebellar cortex in the offspring of rats exposed during pregnancy to 500 ppm *n*-hexane during the first 30 postnatal days (Stoltenburg-Didinger et al.1990). The number of offspring examined was not reported, so it is difficult to assess the significance of this report. *n*-Hexane has not been tested in *in vitro* developmental systems. No information is available on whether parental exposure to *n*-hexane can cause transgenerational effects in children. This appears unlikely since *n*-hexane has tested negative for genotoxicity in a number of *in vivo* and *in vitro* tests. One area of potential concern is the finding that very high air concentrations of *n*-hexane ($\pm 1,000$ ppm) administered for 21-24 hours a day result in signs of testicular damage in rats (De Martino et al.1987; Nylen et al.1989). These signs are also found in rats after large oral doses (Krasavage et al.1980) and the administration of the *n*-hexane metabolite 2,5-hexanedione in drinking water (Chapin et al.1982; Gillies et al.1981). Severe neurotoxicity was evident in all these cases. It is not known whether or not this is a species specific effect, since examination of sperm in a worker population with exposure to *n*-hexane and elevated 2,5 hexanedione urinary levels has not been reported.

No information is available as to whether *n*-hexane or its metabolites cross the placenta in humans. Transfer across the placenta has been demonstrated in rats for *n*-hexane and two resulting metabolites, 2-hexanone and 2,5-hexanedione (Bus et al.1979); no preferential distribution to the fetus was observed for either *n*-hexane or the metabolites. Due to its relatively rapid metabolism, storage of *n*-hexane in body fat does not appear to occur at air concentrations to which humans are exposed; thus, there is unlikely to be mobilization of maternally stored *n*-hexane upon pregnancy or lactation. *n*-Hexane has been detected in samples of human breast milk (Pellizzari et al.1982); however, *n*-hexane was not quantified, nor was any attempt made to assess the subjects' exposure. A human milk/blood partition coefficient of 2.10 (Fisher et al.1997) indicates there would be preferential distribution to this compartment if significant absorption occurred; however no pharmacokinetic experiments have been done to confirm that *n*-hexane or its metabolites are actually transferred to mammalian breast milk. No information is available on *n*-hexane metabolites in breast milk. A PBPK model has been developed that simulates the transfer of *n*-hexane from

2. HEALTH EFFECTS

a mother to a nursing infant during and after occupational exposure via inhalation (Fisher et al. 1997). Blood/air and milk/air partition coefficients were determined with samples from volunteers. Simulations were run over a 24-hour period at the *n*-hexane Threshold Limit Value (TLV) for workplace exposure of 50 ppm, assuming a 9-hour working period containing 2 half-hour and one 1-hour break periods and 8 nursing periods over 24 hours. Total *n*-hexane ingested in milk was compared to the EPA Health Advisory Intake for chronic ingestion of contaminated water by 10-kg children. The model predicted ingestion at the rate of 0.052 mg/day compared to the EPA advisory intake of 4 mg/day.

No information is available on the toxicokinetics of *n*-hexane in children or in young animals compared to adult animals. No information is available as to whether metabolism of *n*-hexane in children differs from that of adults. No studies were located comparing metabolism in young and adult animals. The toxicity of *n*-hexane results from biotransformations yielding the active metabolite 2,5-hexanedione. The initial step is an oxidation to 2-hexanol catalyzed by a cytochrome P-450 enzyme. Some P-450 enzymes are developmentally regulated (Leeder and Kearns 1997); however, it is not completely clear which P-450 enzymes are involved in *n*-hexane metabolism.

No information is available on whether biomarkers for exposure or effect of *n*-hexane validated in adults (exhaled *n*-hexane, 2,5-hexanedione in urine) also are valid for children. Interactions of *n*-hexane with other chemicals have not been reported in children, but have occurred in adults (Altenkirch et al. 1977). Since interactions in adults are dependent on toxicokinetic parameters, predicting interactions in children requires greater understanding of the metabolism of *n*-hexane in children.

2.7 BIOMARKERS OF EXPOSURE AND EFFECT

Biomarkers are broadly defined as indicators signaling events in biologic systems or samples. They have been classified as markers of exposure, markers of effect, and markers of susceptibility (NAS/NRC 1989).

Due to a nascent understanding of the use and interpretation of biomarkers, implementation of biomarkers as tools of exposure in the general population is very limited. A biomarker of exposure is a xenobiotic substance or its metabolite(s), or the product of an interaction between a xenobiotic agent and some target molecule(s) or cell(s) that is measured within a compartment of an organism (NRC 1989). The preferred biomarkers of exposure are generally the substance itself or substance-specific metabolites in readily obtainable body fluid(s) or excreta. However, several factors can confound the use and interpretation of

2. HEALTH EFFECTS

biomarkers of exposure. The body burden of a substance may be the result of exposures from more than one source. The substance being measured may be a metabolite of another xenobiotic substance (e.g., high urinary levels of phenol can result from exposure to several different aromatic compounds). Depending on the properties of the substance (e.g., biologic half-life) and environmental conditions (e.g., duration and route of exposure), the substance and all of its metabolites may have left the body by the time samples can be taken. It may be difficult to identify individuals exposed to hazardous substances that are commonly found in body tissues and fluids (e.g., essential mineral nutrients such as copper, zinc, and selenium). Biomarkers of exposure to *n*-hexane are discussed in Section 2.7.1.

Biomarkers of effect are defined as any measurable biochemical, physiologic, or other alteration within an organism that, depending on magnitude, can be recognized as an established or potential health impairment or disease (NAS/NRC 1989). This definition encompasses biochemical or cellular signals of tissue dysfunction (e.g., increased liver enzyme activity or pathologic changes in female genital epithelial cells), as well as physiologic signs of dysfunction such as increased blood pressure or decreased lung capacity. Note that these markers are not often substance specific. They also may not be directly adverse, but can indicate potential health impairment (e.g., DNA adducts). Biomarkers of effects caused by *n*-hexane are discussed in Section 2.7.2.

A biomarker of susceptibility is an indicator of an inherent or acquired limitation of an organism's ability to respond to the challenge of exposure to a specific xenobiotic substance. It can be an intrinsic genetic or other characteristic or a preexisting disease that results in an increase in absorbed dose, a decrease in the biologically effective dose, or a target tissue response. If biomarkers of susceptibility exist, they are discussed in Section 2.9, Populations That Are Unusually Susceptible.

2.7.1 Biomarkers Used to Identify or Quantify Exposure to *n*-Hexane

n-Hexane can be measured in exhaled breath during and following exposure (Mutti et al.1984; Raymer and Pellizzari 1996; Veulemans et al.1982). At exposure concentrations of 100-200 ppm, *n*-hexane can probably be detected in exhaled air for about 12-24 hours. While this is the most direct method to identify and quantify exposure to *n*-hexane, these measurements require specialized equipment and are used mainly in research studies.

2. HEALTH EFFECTS

Exposure to *n*-hexane results in the production of metabolites by microsomal oxidative enzymes in the liver. The major metabolite appearing in the urine is the neurotoxic metabolite 2,5-hexanedione. The amount of this metabolite in urine has shown a good correlation with concentrations of *n*-hexane in the workplace air (Mutti et al.1984). Urinary metabolite concentrations were lowest at the beginning of the shift, highest at the end of the shift, and still elevated the next morning. There was a strong correlation ($r=0.967$) between time-weighted average *n*-hexane air concentration and end-of-shift 2,5-hexanedione in the urine; end-of-shift samples gave the best estimate of overall exposure. In this study, it was found that about 3 mg 2,5-hexanedione/g creatinine would correspond to about 50 ppm of *n*-hexane in the air, the PEL proposed by OSHA in 1989, but struck down in court.

Since *n*-hexane and its metabolites are cleared from the body within a few days, a test for 2,5-hexanedione in the urine is only a biomarker for recent exposure. Another neurotoxic solvent, 2-hexanone (methyl *n*-butyl ketone), also has 2,5-hexanedione as a metabolite, hence exposure to this chemical would have to be ruled out before exposure to *n*-hexane could be confirmed. 2-Hexanone is also a metabolite of *n*-hexane but is present in much smaller quantities in urine after exposure than is 2,5-hexanedione (Fedtke and Bolt 1987).

2,5-Hexanedione is usually measured as “total” 2,5-hexanedione, a free form accounting for about 10% of the total and 4,5-dihydroxy-2-hexanone, which is converted to 2,5-hexanedione upon acid treatment (acidification of urine samples is routinely performed in order to hydrolyze conjugates that can interfere with analysis). 2,5-Hexanedione has also been detected after acid treatment of urine from individuals not occupationally exposed to *n*-hexane (Fedtke and Bolt 1986a; Perbellini et al.1993). A reference value for 2,5-hexanedione in acid-treated urine in a non-occupationally exposed Italian population ($n= 123$, 60 males, 63 females) has been determined (Bavazzano et al.1998). This value, defined as the upper unilateral 95% tolerance interval at 95% confidence, was 0.795 mg 2,5-hexanedione/L in males and 0.627 mg/L for females. It is possible that small amounts of *n*-hexane are produced in the body by lipid peroxidation, as has been demonstrated for *n*-pentane (Filser et al.1983). Urinary excretion of 2,5-hexanedione ranged from 0.3 to 1.2 mg in 24 hours for unexposed individuals. Workers exposed to approximately 50 ppm *n*-hexane excreted 3-4 mg/24 hours (Perbellini et al.1993).

Pyrrolidation of proteins appears to be a necessary step in *n*-hexane neurotoxicity, and the targets relevant to toxicity are thought to be neuronal axon proteins (Graham et al.1995). However, *n*-hexane metabolites can pyrrolidate a variety of proteins at lysine residues, which upon oxidation can become crosslinked.

2. HEALTH EFFECTS

Pyrrolidated proteins in rat hair have been measured after intraperitoneal administration of 2,5-hexanedione (Johnson et al.1995). Serial analysis of nose hairs taken during 2,5-hexanedione administration showed a progression with time of the region staining positively for pyrroles. This method may eventually be useful as a biomarker for past exposure to *n*-hexane in humans. A more sensitive and rapid biomarker for 2,5-hexanedione exposure is the crosslinking of erythrocyte spectrin, where the altered migration of crosslinked spectrin is easily observable in polyacrylamide gels (Anthony et al.1983). Further research is needed to determine whether exposure to *n*-hexane also results in adduct formation and/or crosslinking of spectrin via metabolism to 2,5-hexanedione.

2.7.2 Biomarkers Used to Characterize Effects Caused by *n*-Hexane

There are currently no subtle or sensitive biomarkers of effects associated with exposure to *n*-hexane, although this is an active area of research. Electroneuromyographic testing may prove useful in the detection of nerve conduction abnormalities in their early stages before they are accompanied by clinical manifestations. In a study of 15 women who had been exposed to *n*-hexane in a shoe factory, all nerve conduction velocities (motor and sensory) were significantly slowed in exposed workers compared to controls (Mutti et al.1982b); the effects of the *n*-hexane may have been exacerbated by co-exposure to methyl ethyl ketone. None of these women had clinical signs of peripheral neuropathy. In a study of workers with relatively high urinary 2,5-hexanedione levels (indicating exposure), clinical exams were negative for neuropathy (Pastore et al.1994). Sensory and motor nerve conduction velocities and distal latencies were normal in all nerves tested; however, significant decreases were found in sensory nerve action potential amplitude when compared with an unmatched control group. Neither the level of 2,5-hexanedione in urine nor the age of the workers correlated with the changes in amplitude; however, there was a significant correlation between years worked and decreased amplitude. In contrast, no correlation was found with the length of exposure in another study of asymptomatic workers where 14 of 40 showed abnormalities on electrophysiological testing. Levels of 2,5-hexanedione in the urine correlated with a numerical index for abnormalities (Governa et al.1987).

Pyrrolidation and crosslinking of proteins can be considered biomarkers of either exposure or effect and are discussed in the previous section.

2. HEALTH EFFECTS

For more information on biomarkers for renal and hepatic effects of chemicals see *ATSDR/CDC Subcommittee Report on Biological indicators of Organ Damage* (1990) and for information on biomarkers for neurological effects see OTA (1990).

2.8 INTERACTIONS WITH OTHER CHEMICALS

Because many other chemicals can affect the enzymes responsible for *n*-hexane metabolism (see Section 2.3.3, Metabolism), the possibility of interactions is a significant concern. The initial step in *n*-hexane metabolism is oxidation to a hexanol by a cytochrome P-450 isozyme; other chemicals can induce these enzymes, possibly increasing the rate of metabolism to the neurotoxic 2,5-hexanedione, or competing with *n*-hexane and its metabolites at enzyme active sites, reducing the rate of metabolism. Interactive effects can be concentration and/or duration dependent.

Altering the *n*-hexane concentration of a paint thinner appears to have been the cause of an outbreak of peripheral neuropathy in Berlin in the 1970s (Altenkirch et al. 1977). In a case series of glue-sniffers in Berlin, the neurological symptoms consisted of a symmetrical, progressive, ascending, mainly motor, neuropathy with pronounced muscle atrophy. The height of the disease was reached after 1½ to 2½ months and resulted in quadriplegia in 7 of 17 patients. After 8 months, all patients still had a motor deficit. Nerve biopsy showed paranodal axon swelling, dense masses of neurofilaments, and secondary myelin retraction. The formulation of the thinner had been changed shortly before illness occurred. The *n*-hexane proportion was reduced from 31 to 16%, but methyl ethyl ketone had been added. The authors hypothesized that methyl ethyl ketone had caused a synergistic effect to occur, resulting in *n*-hexane neurotoxicity. In experiments with male Wistar rats, co-exposure to *n*-hexane and methyl ethyl ketone for 9 weeks resulted in an earlier onset of signs of neurotoxicity than with *n*-hexane alone (Altenkirch et al. 1982). Similarly, co-exposure to 2,000 ppm *n*-hexane and 2,000 ppm methyl ethyl ketone over 20 weeks significantly enhanced clinical and electrophysiological signs of neurotoxicity in Wistar rats compared to 2,000 ppm *n*-hexane alone (Ichihara et al. 1998). This was accompanied by an approximate doubling in urinary 2,5-hexanedione concentrations.

The potentiation of *n*-hexane neurotoxicity by co-exposure to methyl ethyl ketone may be duration-dependent, as suggested by an experiment in volunteers (Van Engelen et al. 1997). Simultaneous exposure to 60 ppm *n*-hexane and either 200 or 300 ppm methyl ethyl ketone for 15.5 minutes had no effect on exhaled *n*-hexane concentrations, and actually lowered 2,5-hexanedione serum concentrations about 3-fold.

2. HEALTH EFFECTS

Time to peak 2,5-hexanedione concentrations was approximately doubled (18-30 minutes). These results are consistent with methyl ethyl ketone inhibiting the metabolism of *n*-hexane during a single acute exposure. Oral exposure to methyl ethyl ketone prior to inhalation exposure to *n*-hexane significantly increased blood levels of the neurotoxic metabolite, 2,5-hexanedione in Fischer 344 rats (Robertson et al. 1989).

The interaction of *n*-hexane with toluene and trichloroethylene has also been examined in volunteers (Baelum et al.1998). Exposure in these experiments was via a gastric feeding tube at controlled rates equivalent to what the authors stated would be delivered to the liver by inhalation exposure at Danish occupational exposure limits (50 ppm *n*-hexane, 50 ppm toluene, and 30 ppm trichloroethylene). Coexposure to toluene and trichloroethylene slightly increased the area under the curve (AUC) representing concentration versus time for end exhaled *n*-hexane air concentration, but urinary excretion of 2,5-hexanedione was unchanged. The only statistically significant interaction observed with *n*-hexane was an 18% decrease in the urinary excretion of hippuric acid, a toluene metabolite.

Indirect evidence for an effect of co-exposure to acetone on *n*-hexane metabolism in humans has been described (Cardona et al.1996). In this study, the relationship between free and total 2,5-hexanedione (2,5-hexanedione and 4,5-dihydroxy-2-hexanone, See Section 2.7) in urine and workplace air concentrations of *n*-hexane, hexane isomers, acetone, and toluene was analyzed in a group of 87 workers. Median *n*-hexane concentrations were 47 mg/m³ (range, 4-652 mg/m³ [13 ppm; range, 1-185 ppm]) and median acetone concentrations (only 70 of the 87 workers were exposed) were 109 mg/m³ (range, 1-1,826 mg/m³ [46 ppm; range, 0.4-769 ppm]). A statistically significant correlation was found between air levels of acetone and the ratios of free and total 2,5-hexanedione to air levels of *n*-hexane. Multiple regression analysis indicated that at a given level of *n*-hexane exposure, co-exposure to acetone increases the level of free 2,5-hexanedione in urine while reducing the level of 4,5-dihydroxy-2-hexanone.

Oral administration of acetone has been reported to potentiate the neurotoxicity caused by oral exposure to the *n*-hexane metabolite 2,5-hexanedione in rats (Ladefoged et al.1989, 1994). Oral exposure to acetone alone in rats at 650 mg/kg/day resulted in a statistically significant decrease in motor nerve conduction velocity after 6 weeks; co-exposure to acetone and 2,5-hexanedione resulted in greater effects than those seen with 2,5-hexanedione alone (Ladefoged et al.1989). It is possible that acetone may potentiate *n*-hexane neurotoxicity by decreasing body clearance of 2,5-hexanedione (Ladefoged and Perbellini 1986). Acetone also influences the action of many chemicals by its induction of the cytochrome P-450 isozyme

2. HEALTH EFFECTS

CYP2E1 (Patten et al.1986). *n*-Hexane is metabolized by P-450 isozymes (see Section 2.4), so induction by acetone may result in an increased production of the neurotoxic metabolite 2,5-hexanedione.

Co-exposure to *n*-hexane and xylene resulted in a loss of auditory sensitivity in male Sprague-Dawley rats (Nylen et al.1994) as measured by the auditory brainstem response. Exposure to *n*-hexane or xylene alone at 1,000 ppm for 61 days for 18 hours a day caused a slight loss of auditory sensitivity when measured 2 days after the end of exposure. Simultaneous exposure to *n*-hexane and xylene (1,000 ppm each) caused a greater and persistent loss of auditory sensitivity which was greater than the sum of effects of exposure to *n*-hexane and xylene separately. These effects were still observed 4 and 10 months after exposure ended. In contrast, combined exposure to *n*-hexane and xylene partially reversed the decreased nerve conduction velocities and action potential amplitudes observed in the group treated with *n*-hexane alone. These effects were persistent from 2 days to 10 months after cessation of exposure.

In a similar experiment with *n*-hexane and toluene (Nylen and Hagman 1994), a reduction in auditory sensitivity compared to controls was observed 2 days after exposure to toluene with *n*-hexane (1,000 ppm each), but not after exposure to *n*-hexane alone. Loss of sensitivity was 5 ± 7 decibels (dB) in the *n*-hexane alone group, 24 ± 11 dB in the toluene alone group, and 31 ± 16 dB in the combined group. The loss in the combined group was significantly higher than in the toluene alone group. The reduction lasted one year after the exposure. Exposure to *n*-hexane alone caused a marked decrease in peripheral nerve conduction velocities. Co-exposure to *n*-hexane and toluene prevented these effects.

In a study where both peripheral and central nervous system effects were measured in rats co-exposed to *n*-hexane and toluene (Pryor and Rebert 1992), toluene exposure at 1,400 ppm for 14 hours a day for 9 weeks prevented the peripheral neurotoxicity (decreased grip strength and nerve conduction velocities) caused by exposure to 4,000 ppm *n*-hexane alone. There was no reciprocal action of *n*-hexane on the motor syndrome (shortened and widened gait and widened landing foot splay) and hearing loss caused by toluene. Brainstem auditory response amplitudes were decreased by *n*-hexane, co-exposure to toluene did not block this effect.

Co-exposure to approximately equal concentrations of xylene or toluene (Nylen et al.1989) has also prevented *n*-hexane-induced testicular atrophy in Sprague-Dawley rats. The protective effects of xylene and toluene on peripheral neuropathy and testicular atrophy caused by *n*-hexane may result from competition for metabolism, resulting in a slowing of *n*-hexane conversion to 2,5-hexanedione.

2. HEALTH EFFECTS

2.9 POPULATIONS THAT ARE UNUSUALLY SUSCEPTIBLE

A susceptible population will exhibit a different or enhanced response to *n*-hexane than will most persons exposed to the same level of *n*-hexane in the environment. Reasons may include genetic makeup, age, health and nutritional status, and exposure to other toxic substances (e.g., cigarette smoke). These parameters may result in reduced detoxification or excretion of *n*-hexane, or compromised function of target organs affected by *n*-hexane. Populations who are at greater risk due to their unusually high exposure to *n*-hexane are discussed in Section 5.7, Populations With Potentially High Exposure.

No population has been identified which is unusually susceptible to toxic effects resulting from *n*-hexane exposure. It is possible that individuals with diminished peripheral nerve function may be more susceptible to *n*-hexane neurotoxicity than the general population. This group would include diabetics, alcoholics and the aged.

2.10 METHODS FOR REDUCING TOXIC EFFECTS

This section will describe clinical practice and research concerning methods for reducing toxic effects of exposure to *n*-hexane. However, because some of the treatments discussed may be experimental and unproven, this section should not be used as a guide for treatment of exposures to *n*-hexane. When specific exposures have occurred, poison control centers and medical toxicologists should be consulted for medical advice. The following texts provide specific information about treatment following exposures to *n*-hexane.

R.H. Dreisbach, ed.1987. Handbook of Poisoning. Appleton and Lange, Norwalk.

L.M. Haddad and J.F. Winchester, eds.1990. Clinical Management of Poisoning and Drug Overdose, 2nd. edition. W.B. Saunders, Philadelphia.

C.K. Aaron and M.A. Howland, eds.1994. Goldfrank's Toxicologic Emergencies, 5th edition. Norwalk.

Treatment information specific to *n*-hexane exposure was not located. Treatment of acute exposure to *n*-hexane would be similar to that for other aliphatic hydrocarbons.

2. HEALTH EFFECTS

2.10.1 Reducing Peak Absorption Following Exposure

Because of the high volatility of liquid *n*-hexane, the most likely route of exposure is via inhalation. In this case, removal of the individual from the source of the *n*-hexane halts absorption. Residual *n*-hexane in alveolar air would leave the lung within a few minutes. In the case of ingestion, the major danger with *n*-hexane (and other liquid aliphatic hydrocarbons) is not absorption from the gastrointestinal tract, but rather the risk of chemical pneumonitis after aspiration into the lungs (Ervin and Manske 1990). Since this type of aspiration can occur during vomiting, induction of emesis is not recommended. An exception would be in the case where the *n*-hexane contained other potentially toxic agents (e.g., pesticides, organosoluble metal compounds). Careful gastric lavage may be necessary in this situation (Klein and Simon 1986). No binding agents have been identified for the aliphatic hydrocarbons. In the case of dermal exposure, removal of *n*-hexane from the skin with large amounts of soap and water would reduce absorption by this route.

2.10.2 Reducing Body Burden

Neither *n*-hexane nor its metabolites are retained to any significant extent by the body, so methods to reduce the body burden would not be necessary in the treatment of toxic effects caused by *n*-hexane exposure.

2.10.3 Interfering with the Mechanism of Action for Toxic Effects

n-Hexane toxicity appears to be caused by the action of one of its metabolites, 2,5-hexanedione, on the cytoskeletal structures of axons in peripheral nerve. The damage in the individual axon is cumulative as long as exposure continues and eventually affects action potential conduction, producing clinical signs of peripheral neuropathy. The initial step in this process appears to be pyrrolidation of protein followed by cross-linking. While this is a potential step for interfering with the mechanism of action for toxic effects, no methods currently exist that would accomplish this. Pyrrole-to-pyrrole crosslinking can be inhibited *in vitro* by thiol-containing compounds including *N*-acetylcysteine and glutathione (Zhu et al. 1995). Future research might identify a way to deliver these inhibitory compounds to the site of pyrrole crosslinking. Additionally, any method that would reduce peak serum concentrations of 2,5-hexanedione after *n*-hexane exposure would also be useful, but none were identified.

2. HEALTH EFFECTS

2.11 ADEQUACY OF THE DATABASE

Section 104(i)(5) of CERCLA, as amended, directs the Administrator of ATSDR (in consultation with the Administrator of EPA and agencies and programs of the Public Health Service) to assess whether adequate information on the health effects of *n*-hexane is available. Where adequate information is not available, ATSDR, in conjunction with the National Toxicology Program (NTP), is required to assure the initiation of a program of research designed to determine the health effects (and techniques for developing methods to determine such health effects) of *n*-hexane.

The following categories of possible data needs have been identified by a joint team of scientists from ATSDR, NTP, and EPA. They are defined as substance-specific informational needs that if met would reduce the uncertainties of human health assessment. This definition should not be interpreted to mean that all data needs discussed in this section must be filled. In the future, the identified data needs will be evaluated and prioritized, and a substance-specific research agenda will be proposed.

2.11.1 Existing Information on Health Effects of *n*-Hexane

The existing data on health effects of inhalation, oral, and dermal exposure of humans and animals to *n*-hexane are summarized in Figure 2-8. The purpose of this figure is to illustrate the existing information concerning the health effects of *n*-hexane. Each dot in the figure indicates that one or more studies provide information associated with that particular effect. The dot does not necessarily imply anything about the quality of the study or studies, nor should missing information in this figure be interpreted as a “data need.” A data need, as defined in ATSDR’s *Decision Guide for Identifying Substance-Specific Data Needs Related to Toxicological Profiles* (ATSDR 1989), is substance-specific information necessary to conduct comprehensive public health assessments. Generally, ATSDR defines a data gap more broadly as any substance-specific information missing from the scientific literature.

2.11.2 Identification of Data Needs

Acute-Duration Exposure. *n*-Hexane appears to be of low acute toxicity. *n*-Hexane in air is not irritating to humans (Nelson et al. 1943) and the only human health effect reported after acute-duration exposure is dermal irritation with undiluted liquid *n*-hexane (Wahlberg 1984). No reports of oral toxicity to *n*-hexane in humans were located. Oral LD₅₀ values in Sprague-Dawley rats range from 15,840 to

2. HEALTH EFFECTS

Figure 2-8. Existing Information on Health Effects of *n*-Hexane

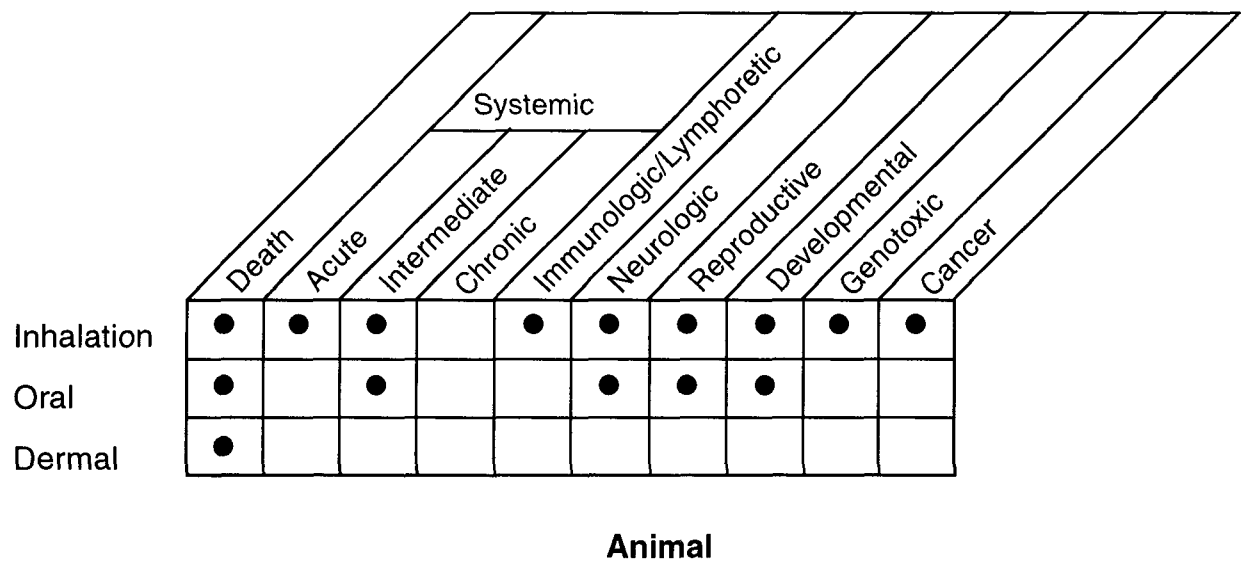
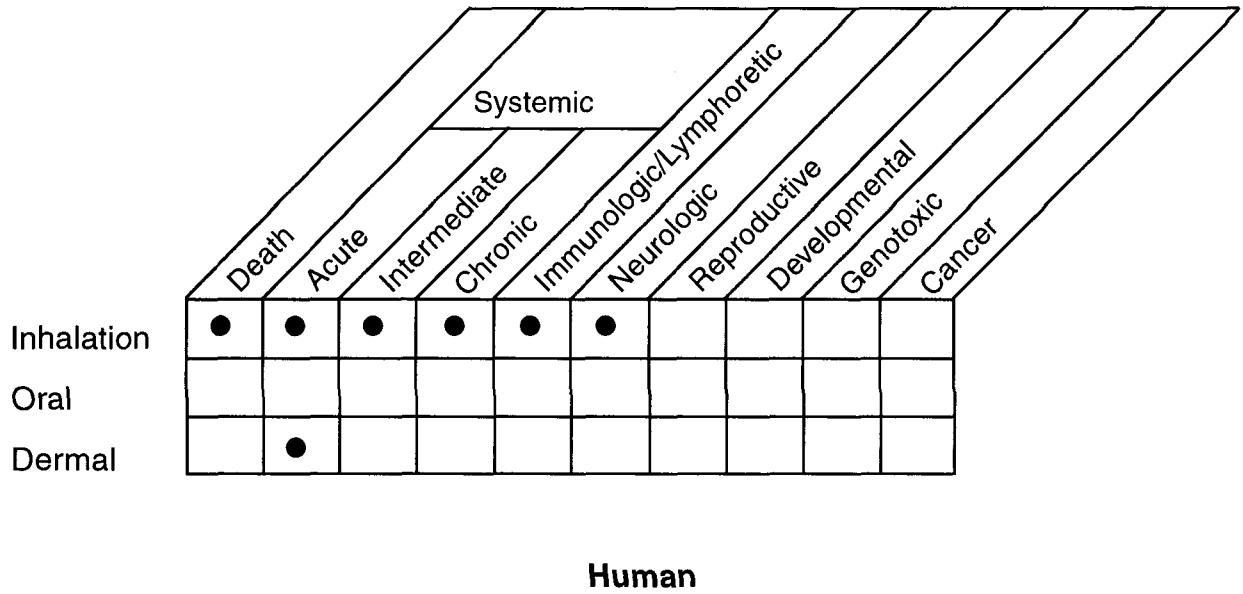

● Existing Studies

2. HEALTH EFFECTS

32,340 mg/kg, depending on age (Kimura et al.1971). No deaths have been reported in animals after acute-duration inhalation exposure at concentrations up to the practical upper limit for experimental *n*-hexane exposure of 10,000 ppm (Dunnick et al.1989; NTP 1991). Respiratory effects (rales, gasping, mouth breathing) have been reported in rabbits during acute-duration inhalation exposure at 3,000 ppm (Lungarella et al.1984) and a reduction in motor nerve conduction velocity in rats after a 1-week exposure to 5,000 ppm *n*-hexane (De Martino et al.1987). Reproductive effects in male rats (altered sperm morphology) have been reported after a 24-hour exposure to 5,000 ppm (De Martino et al.1987). Existing data are insufficient to derive an acute-duration MRL for any route of exposure. Acute-duration inhalation studies may be useful to establish threshold levels and dose-response relationships for the reproductive and neurological effects seen in the De Martino et al. (1987) study. Although no thorough studies of acute inhalation effects have been done, except for developmental end points, the intermediate and chronic database would not suggest any particular end points of concern besides neurological and reproductive effects. Oral exposure is an unlikely route for human exposure due to the volatility of *n*-hexane, so acute-duration oral studies are not needed as critically. However, with deeply buried waste or leaking underground storage tanks, private drinking well water (municipal treatment is likely to volatilize all *n*-hexane at the plant) could become contaminated with *n*-hexane, so oral drinking water studies might be appropriate. The solubility of *n*-hexane in water is very low (9.5 mg/L), so it is questionable whether test animals would ingest enough *n*-hexane to result in any toxic response. Calculations would need to be made on the fluid intake of the animal model before it can be determined if such studies can be conducted. In rat gavage studies, doses $\geq 1,000$ mg/kg/day were necessary to produce neurological effects (Krasawage et al.1980; Ono et al.1981). An acute-duration dermal study in animal models may be useful to obtain toxicokinetic data for this exposure route. There is virtually no data on dermal toxicity, although, again because of the volatility of *n*-hexane, exposure by this route is unlikely and acute-duration toxicity studies are not needed as critically. There is little pharmacokinetic data (one study on *in vitro* skin permeability and one study measuring 2,5-hexanedione levels after oral exposure) on oral or dermal routes of exposure, nor does the Perbellini PBPK model address these routes of exposure, so there is little basis for extrapolating from the target organs of inhalation exposure to the identification of target organs of oral and dermal exposure. However, intermediate-duration toxicity data that does exist would suggest that acute oral exposure targets of particular concern are also the nervous and male reproductive systems.

Intermediate-Duration Exposure. Case studies of occupational exposure to *n*-hexane by the inhalation route show that neurotoxicity can develop in humans over this duration period (Altenkirch et al. 1977; Wang et al.1986; Yamamura 1969). Peripheral neuropathy (both sensory and motor) was the major

2. HEALTH EFFECTS

finding; muscle wasting and atrophy were also observed. No reports of human neurotoxicity after oral or dermal exposure to *n*-hexane were located. Repeated exposures in animals show that a similar form of neurotoxicity can also be produced experimentally, with the rat being the most sensitive species (Altenkirch et al.1982; De Martino et al.1987; Dunnick et al.1989; Frontali et al.1981; Huang et al.1989; IRDC 1981; NTP 1991; Schaumburg and Spencer 1976; Takeuchi et al.1980). *n*-Hexane neurotoxicity can also be induced over the intermediate duration via the oral route in rats at 4,000 mg/kg/day (Krasavage et al. 1980). In another oral exposure study at 1,251 mg/kg/day, decreases in nerve conduction velocity, but no clinical signs of peripheral neuropathy, were observed (Ono et al.1981). Deaths were observed in pregnant mice receiving 2,200-2,830 mg/kg/day, although developmental effects were not observed (Marks et al. 1980).

Reproductive effects (testicular atrophy, degeneration) have been observed in male rats after intermediate duration inhalation exposure at 1,000 ppm *n*-hexane and at 5,000 ppm (De Martino et al.1987; Nylen et al.1989). Atrophy of the testicular germinal epithelium was also observed in an oral exposure in rats at 4,000 mg/kg/day (Krasavage et al.1980). Severe neurotoxicity occurred in all these studies. These effects were not observed in studies in rats using lower concentrations of *n*-hexane or in mice exposed via inhalation to up to 10,000 ppm for 13 weeks (Dunnick et al.1989; NTP 1991). A decrease in ventricular fibrillation potential has been observed in perfused hearts from rats exposed subcutaneously for an intermediate duration to *n*-hexane (Khedun et al.1996).

The critical effect of intermediate-duration exposure to *n*-hexane in humans is neurotoxicity, specifically peripheral neuropathy. No inhalation MRL was derived for this duration because the reports of neurological effects in humans were predominantly case reports with inadequate documentation of exposure levels or comparison with unexposed groups. A large database on neurological effects in rats exists for this duration; however, the design of these experiments precluded documentation of clear dose-response relationships within a single study. Because of the limited database for oral exposure to *n*-hexane and the lack of toxicokinetic data for this route, no MRL was derived for oral exposure to *n*-hexane.

Intermediate-duration inhalation studies establishing a threshold and dose-response for neurological and male reproductive effects in the rat would be useful since this is an area of potential concern for humans exposed to *n*-hexane occupationally or near hazardous waste sites. The only other effects documented after inhalation exposure in animal models for this duration are respiratory effects, and these occur at *n*-hexane levels far above any plausible human exposure; thus, studies on this end point are not necessary. An

2. HEALTH EFFECTS

intermediate-duration inhalation exposure experiment that measures ventricular fibrillation potential may be useful to determine if results seen after subcutaneous exposure (Khedun et al.1996) can be reproduced by an exposure route relevant to humans.

Oral exposure is an unlikely route for human exposure due to the volatility of *n*-hexane, so intermediate-duration oral studies are not needed as critically. However, with deeply buried waste or leaking underground storage tanks, private drinking well water (municipal treatment is likely to volatilize all *n*-hexane at the plant) could become contaminated with *n*-hexane, so oral drinking water studies might be appropriate. The solubility of *n*-hexane in water is very low (9.5 mg/L), so it is questionable whether test animals would ingest enough *n*-hexane to result in any toxic response. Intermediate-duration oral studies may be useful to establish threshold levels and dose response relationships for the reproductive and neurological effects already observed. There is little pharmacokinetic data (one study on *in vitro* skin permeability) for dermal exposure, nor does the Perbellini PBPK model address this route of exposure, so there is little basis for extrapolating from the target organs of inhalation exposure to the identification of dermal exposure targets. There is virtually no data on dermal toxicity, although, again because of the volatility of *n*-hexane, exposure by this route is unlikely and intermediate-duration toxicity studies are not needed as critically.

Chronic-Duration Exposure and Cancer. For chronic-duration exposure, case studies of occupational exposure to *n*-hexane by the inhalation route show that neurotoxicity can develop in humans over this duration period (Yamamura 1969; Wang et al.1986). Peripheral neuropathy (both sensory and motor) was the major finding; muscle wasting and atrophy were also observed. Subclinical effects on nerve conduction velocity and evoked potential response have also been reported over this duration (Mutti et al. 1982a, 1982b; Sanagi et al.1980; Seppalainen et al.1979). An MRL of 0.6 ppm has been derived for this duration exposure based on a study of workers exposed to approximately 58 ppm *n*-hexane for an average of 6 years. A small decrease in motor nerve conduction velocity was observed in these workers compared to an age-matched control group. No clinical signs of toxicity were evident. No reports of human neurotoxicity after oral or dermal exposure to *n*-hexane were located. Both animal and human neurological studies examining both central and peripheral end points are a data need for chronic inhalation exposure. No animal studies exist for chronic inhalation exposure, and all the human studies involve co-exposure to other chemicals. A chronic-duration inhalation exposure experiment that measures ventricular fibrillation potential may be useful to determine if results seen after subcutaneous exposure (Khedun et al.1996) can be reproduced by an exposure route relevant to humans. No chronic-duration exposure studies in animals

2. HEALTH EFFECTS

were located for any route, thus the database was insufficient to derive an oral MRL for chronic-duration exposure. Oral exposure is an unlikely route for human exposure due to the volatility of *n*-hexane, so chronic-duration oral studies are not needed as critically. However, with deeply buried waste or leaking underground storage tanks, private drinking well water (municipal treatment is likely to volatilize all *n*-hexane at the plant) could become contaminated with *n*-hexane, so oral drinking water studies might be appropriate. The solubility of *n*-hexane in water is very low (9.5 mg/L), so it is questionable whether test animals would ingest enough *n*-hexane to result in any toxic response. There is no data on dermal toxicity, although, again because of the volatility of *n*-hexane, exposure by this route is unlikely and chronic-duration toxicity studies are not needed as critically.

There is currently only limited information on the carcinogenic potential of *n*-hexane. No epidemiological studies were located that address this question in humans. Neither structure activity relationships nor mutagenicity assays point to a concern. Papillary tumors, but not the incidence, have been reported in the bronchiolar epithelium of rabbits after a 24-week exposure to 3,000 ppm *n*-hexane (Lungarella et al. 1984). A 2-year study of inhalation exposure with commercial hexane (51.5% *n*-hexane) (Bio/Dynamics 1995a, 1995b) resulted in a significant increase in liver neoplasms in female mice, but no increase at any site in male mice or rats of either sex (Bio/Dynamics 1995a, 1995b). It is unclear what components of the hexane mixture caused the neoplasms. Replication of this study, perhaps with *n*-hexane rather than commercial hexane, and further studies on the mechanism of this effect in female mice (e.g., precancerous changes in the liver) may clarify the significance of this finding for human exposure to *n*-hexane.

Genotoxicity. No information is available on the genotoxicity of *n*-hexane in humans. The database on *n*-hexane in animals, mammalian cells, and microorganisms indicates little potential for genotoxicity. *n*-Hexane was negative in dominant lethal tests in mice by the inhalation route at up to 396 ppm (Litton Bionetics 1980) and at 5,000 ppm (Mast et al. 1989b). In an inhalation study, morphological alterations in sperm were noted in one study on rats at 5,000 ppm *n*-hexane (De Martino et al. 1987). In other *in vivo* tests, subcutaneous injection of *n*-hexane had no significant effect on the incidence of sister chromatid exchange or chromosomal aberrations in mouse bone marrow; inhalation exposure had no effect on micronuclei incidence in mouse erythrocytes (NTP 1991). Results have generally been negative for *n*-hexane in bacterial tester strains such as *E. coli*, *B. subtilis*, and *S. typhimurium* both with and without metabolic activation (Houk et al. 1989; Ishidate et al. 1984; McCarroll et al. 1981a, 1981b; Mortelmans et al. 1986; NTP 1991). Negative results were also obtained in mammalian cells, except for one observation of polyploidy in Chinese hamster CHL cells (Ishidate et al. 1984; NTP 1991; Perocco et al. 1983). Only a

2. HEALTH EFFECTS

single report was located on the genotoxicity of *n*-hexane metabolites; induction of chromosome loss was observed in yeast with 2,5-hexanedione (Mayer and Goin 1994). It is also unclear if incubation with liver microsomes (S9 fraction) in *in vitro* genotoxicity tests results in similar metabolites to those observed in humans *in vivo*.

Reproductive Toxicity. Reproductive effects have not been examined in humans after exposure to *n*-hexane. Dominant lethal tests in mice showed no effect on male fertility (Litton Bionetics 1980). No effects were seen on reproductive tissues in male rats after intermediate-duration inhalation exposure up to 500 ppm (IRDC 1981) or in either sex of mice after intermediate-duration inhalation exposure to up to 10,000 ppm *n*-hexane (Dunnick et al. 1989; NTP 1991). However, inhalation exposure in male rats to higher concentrations of *n*-hexane showed effects after acute-duration exposure to 5,000 ppm (spermatid and spermatocyte degeneration and exfoliation) and testicular atrophy after intermediate-duration exposure to 1,000 ppm (De Martino et al. 1987; Nylen et al. 1989). Atrophy of the testicular germinal epithelium in rats was also noted after intermediate-duration oral exposure at 4,000 mg/kg/day (Krasavage et al. 1980). A study of end points of testicular function should be done in an occupationally exposed group of humans to determine if the effects seen in animals also occur in humans. Animal inhalation studies to more accurately determine the dose-response and threshold levels for testicular effects should also be conducted. oral exposure is an unlikely route for human exposure due to the volatility of *n*-hexane, so oral reproductive studies are not needed as critically. However, with deeply buried waste or leaking underground storage tanks, private drinking well water (municipal treatment is likely to volatilize all *n*-hexane at the plant) could become contaminated with *n*-hexane, so oral drinking water studies might be appropriate. The solubility of *n*-hexane in water is very low (9.5 mg/L), so it is questionable whether test animals would ingest enough *n*-hexane to result in any toxic response. Again, because of the volatility of *n*-hexane, exposure by the dermal route is unlikely and reproductive toxicity studies are not needed as critically.

Developmental Toxicity. Developmental effects have not been examined in humans after exposure to *n*-hexane. Development effects were not observed in acute-duration inhalation animal studies with *n*-hexane except for a temporary decrease in pup weight gain in offspring from pregnant rats exposed via inhalation to 1,000 ppm during gestation days 8-16 (Bus et al., 1979). No effects on offspring were seen in pregnant rats exposed via inhalation to 409 ppm *n*-hexane during gestation days 6-15 (Litton Bionetics 1979). Similar results were seen when pregnant mice were orally exposed to up to 2,830 mg/kg/day *n*-hexane during gestation days 6-15 (Marks et al. 1980). In pregnant female Wistar rats exposed to

2. HEALTH EFFECTS

500 ppm *n*-hexane for 23 hours a day throughout gestation (21 days), reduced body weight of offspring was reported ranging from 22% at postnatal day 9 to 13% at postnatal day 25. Delayed histogenesis of the cerebellar cortex in the offspring of exposed dams was also reported in this study during the first 30 postnatal days (Stoltenburg-Didinger et al. 1990). The number of offspring examined in this study was not reported and statistical analysis of body weights was not performed, so these results need to be confirmed. Reduced fetal weight was seen in this study at 7,920 mg/kg/day, but there was also maternal toxicity at this dose. Developmental studies via the inhalation route in a species other than rats (e.g., rabbits) may be useful to assess the potential developmental toxicity of *n*-hexane exposure in humans. There is also a need for developmental studies in animal models where assessment of neurological, reproductive, and possibly other end points continues up to sexual maturity after exposure to *n*-hexane in *utero* and during maturation. Development of these systems continues after birth, the peripheral nervous system is a known target organ for *n*-hexane neurotoxicity, and reproductive effects have been observed in animal studies. Oral exposure is an unlikely route for human exposure due to the volatility of *n*-hexane, so oral developmental studies are not needed as critically. However, with deeply buried waste or leaking underground storage tanks, private drinking well water (municipal treatment is likely to volatilize all *n*-hexane at the plant) could become contaminated with *n*-hexane, so oral drinking water studies might be appropriate. The solubility of *n*-hexane in water is very low (9.5 mg/L), so it is questionable whether test animals would ingest enough *n*-hexane to result in any toxic response. Again, because of the volatility of *n*-hexane, exposure by the dermal route is unlikely and developmental toxicity studies are not needed as critically.

Immunotoxicity. One report of immunological effects in humans after exposure to *n*-hexane was located (Karakaya et al. 1996) describing a reduction in immunoglobulin levels in a group of 35 workers compared to a control group of 23. The reductions correlated with 2,5-hexanedione in urine but not with workplace *n*-hexane concentrations (23-2 15 ppm). The reductions also remained well within the normal ranges for immunoglobulins in blood, so the toxicological significance of these findings can not be assessed without confirmatory studies (Jackson et al. 1997). Cell counts (lymphocytes, neutrophils, monocytes, eosinophils) were unaffected by *n*-hexane exposure. No reports on dermal sensitization after exposure to *n*-hexane in humans were found in the literature. The animal database is limited to intermediate-duration inhalation studies where immunologic/lymphoreticular tissues were examined histopathologically. No adverse effects were observed in the examined tissues (Cavender et al. 1984; Dunnick et al. 1989; IRDC 1981; NTP 1991). An increase in lymphocytes in the blood was noted after exposure of mice to 10,000 ppm *n*-hexane; however, this was attributed to inflammation of the respiratory tract in these

2. HEALTH EFFECTS

animals (Dunnick et al.1989; NTP 1991). A battery of immunological-function tests after inhalation exposure to *n*-hexane in rats may provide information on whether immunological effects may be a concern for humans exposed near hazardous waste sites. Oral exposure is an unlikely route for human exposure due to the volatility of *n*-hexane, so oral immunological studies are not needed as critically. However, with deeply buried waste or leaking underground storage tanks, private drinking well water (municipal treatment is likely to volatilize all *n*-hexane at the plant) could become contaminated with *n*-hexane, so oral drinking water studies might be appropriate. The solubility of *n*-hexane in water is very low (9.5 mg/L), so it is questionable whether test animals would ingest enough *n*-hexane to result in any toxic response. Again, because of the volatility of *n*-hexane, exposure by the dermal route is unlikely and immunological toxicity studies are not needed as critically.

Neurotoxicity. The major public health concern regarding *n*-hexane exposure is the potential for the development of neurotoxicity. Occupational studies have documented that human exposure to *n*-hexane can result in a peripheral neuropathy that in severe cases can lead to paralysis (Altenkirch et al.1977; Yamamura 1969; Wang et al.1986). The dose-duration relationship has not been well characterized in humans, but concentrations of 500 ppm and above and exposure for 6 months or more have been associated with human neurotoxicity. Clinical neurotoxicity can be reproduced in rats, but not in other test species, via the inhalation and oral routes (Altenkirch et al.1982; De Martino et al.1987; Dunnick et al. 1989; Frontali et al.1981; Huang et al.1989; IRDC 1981; Krasavage et al.1980; NTP 1991; Schaumburg and Spencer 1976; Takeuchi et al.1980). Other data needs are the determination of threshold levels for neurotoxicity for acute- and intermediate-duration inhalation exposure in the rat model, and the effect of age on susceptibility to *n*-hexane. There are no chronic-duration neurotoxicity studies in animals; such an inhalation study should evaluate both peripheral and central targets. Oral exposure is an unlikely route for human exposure due to the volatility of *n*-hexane, so oral neurological studies are not needed as critically. However, with deeply buried waste or leaking underground storage tanks, private drinking well water (municipal treatment is likely to volatilize all *n*-hexane at the plant) could become contaminated with *n*-hexane, so oral drinking water studies might be appropriate. The solubility of *n*-hexane in water is very low (9.5 mg/L), so it is questionable whether test animals would ingest enough *n*-hexane to result in any toxic response. Again, because of the volatility of *n*-hexane, exposure by the dermal route is unlikely and neurological toxicity studies are not needed as critically.

The molecular mechanism responsible for the axonal swelling, demyelination, and axonal degeneration seen in human *n*-hexane neurotoxicity has not been completely proven, although it is believed to be related to the

2. HEALTH EFFECTS

pyrrolidation of neuronal proteins by the neurotoxic metabolite 2,5-hexanedione. Whether neurofilament cross-linking is key to the neurofilament accumulation, axonal swellings, and ultimate axonal degeneration observed in *n*-hexane neurotoxicity or is incidental remains to be elucidated (Graham et al.1995). The puzzling observation that the active *n*-hexane metabolite 2,5-hexanedione actually speeds rather than slows axonal transport (Pyle et al.1993) deserves better explanation and perhaps replication. Further studies in the rat model to answer this important question would be helpful in human risk assessment.

Epidemiological and Human Dosimetry Studies. Epidemiological information is available for the effects caused by occupational exposure to *n*-hexane. A complicating factor in these studies is that workers are almost always exposed to many other chemicals besides *n*-hexane. Epidemiological studies that followed populations exposed to *n*-hexane either in the workplace or near hazardous waste sites would be useful in assessing adverse effects in humans. Of particular importance are reproductive effects in males and whether any relationship exists between *n*-hexane exposure and chronic degenerative neurological diseases. Human dosimetry studies would be useful in associating *n*-hexane levels with the reported effects.

Biomarkers of Exposure and Effect.

Exposure. The presence of the *n*-hexane metabolite 2,5-hexanedione in the urine is a reasonably reliable marker for exposure to *n*-hexane and has been correlated with air concentrations in the workplace. This is not a specific marker since 2-hexanone is also metabolized to 2,5-hexanedione. The levels of this metabolite in the urine associated with neurotoxicity are not known. A more sensitive marker for exposure may be the presence of pyrrolidated proteins in the blood or hair, a result of the reaction of 2,5-hexanedione with the side-chain amino group of lysine (Graham et al.1995; Johnson et al.1995). These methods have only been tested after oral exposure to 2,5-hexanedione in the rat model. It would be very useful to know if measurement of pyrrole adducts or cross-linked proteins is also feasible after inhalation exposure to *n*-hexane in the rat model. Further development and validation of this method in an occupationally exposed population may then be useful.

Effect. There are currently no subtle or sensitive biomarkers of effects associated specifically with exposure to *n*-hexane. Electroneurographic testing, however, may prove useful in the detection of nerve conduction abnormalities in their early stages before they are accompanied by clinical manifestations. In a study of 15 women who had been exposed to *n*-hexane in a shoe factory, all nerve conduction velocities

2. HEALTH EFFECTS

(motor and sensory) were significantly slowed in exposed workers compared to controls (Mutti et al. 1982b). None of these women had clinical signs of peripheral neuropathy. Two studies suggest that the most sensitive electrophysiological biomarker of effect in *n*-hexane exposed workers may be the amplitude of the sensory nerve action potential, while amplitude of the motor nerve action potential, nerve conduction velocities, and distal latencies are less sensitive (Chang et al. 1993; Pastore et al. 1994). Further studies correlating electrophysiological studies with biomarkers of *n*-hexane exposure would be useful.

Pyrrolidation and crosslinking of proteins can be considered biomarkers of either exposure or effect and are discussed in the previous subsection.

Absorption, Distribution, Metabolism, and Excretion. Toxicokinetic information is available for the inhalation route in humans and animals but is almost totally lacking for the oral and dermal routes. Inhaled *n*-hexane is readily absorbed in the lungs. In humans, approximately 20-30% of inhaled *n*-hexane is absorbed systemically. Absorption takes place by passive diffusion through epithelial cell membranes. Inhaled *n*-hexane distributes throughout the body; based on blood-tissue partition coefficients, preferential distribution would be in the order: body fat>>liver, brain, muscle>kidney, heart, lung>blood. *n*-Hexane is metabolized by mixed function oxidases in the liver to a number of metabolites including the neurotoxicant 2,5-hexanedione. Approximately 10-20% of absorbed *n*-hexane is excreted unchanged in exhaled air, and 2,5-hexanedione is the major metabolite recovered in urine. *n*-Hexane metabolites in the urine and *n*-hexane in exhaled air do not account for total intake, suggesting that some of the metabolites of *n*-hexane enter intermediary metabolism. Saturation of metabolism occurs in rats at $\geq 3,000$ ppm, far above any plausible human exposure. Further studies in animals via the oral and dermal routes are necessary to assess whether significant toxicity is likely to occur in humans exposed by these routes. A PBPK model exists for *n*-hexane which successfully predicts blood levels of *n*-hexane and urinary excretion of 2,5-hexanedione (Perbellini et al. 1986, 1990a) in exposed humans. Thus, further kinetic studies in humans (e.g., metabolism in human liver homogenates) are not necessary.

Comparative Toxicokinetics. The toxicokinetic studies available indicate that the rat is a good model for human neurotoxicity observed after occupational exposure to *n*-hexane. Mild signs can be produced in chickens and mice, but these do not progress to the serious neurotoxicity observed in humans and rats. Toxicokinetic data from other species (absorption, distribution, metabolism, excretion) could provide insight on the molecular mechanism(s) of the species specificity of *n*-hexane toxicity and would be valuable for predicting toxic effects in humans.

2. HEALTH EFFECTS

Methods for Reducing Toxic Effects. No information was located on mitigating the specific effects of *n*-hexane intoxication. Since the mechanism of absorption is passive diffusion, removal from exposure stops absorption. Distribution is via partitioning based on physicochemical properties. Toxicity is due to the neurotoxic metabolite 2,5-hexanedione. Methods to reduce this metabolite in the blood would be useful. The specific mechanism of action is unknown, although there is strong evidence that pyrrolidation of proteins by 2,5-hexanedione followed by crosslinking is involved. Methods to prevent this reaction may be helpful; none currently exist. Pyrrole-to-pyrrole crosslinking can be inhibited *in vitro* by thiol-containing compounds including *N*-acetylcysteine and glutathione (Zhu et al.1995). Future research in the rat model might identify a way to deliver these inhibitory compounds to the site of pyrrole crosslinking. Clinical experience with *n*-hexane neurotoxicity is that once exposure ceases, recovery occurs over several months to a year. Supportive treatment would be similar to that for peripheral neuropathies caused by other conditions, for example diabetes.

Children's Susceptibility. There are no populations of children identified that have been specifically exposed to *n*-hexane, although several teenagers have developed peripheral neuropathy after *n*-hexane exposure by solvent abuse (Altenkirch et al.1977) and in the workplace (Yamamura et al.1969). These reports did not indicate any difference in susceptibility or clinical signs between teenagers and adults. Animal studies provide limited further information; only 2 studies were located where the responses to *n*-hexane were compared between young animals and adults. In a study in rats directly comparing the effects of *n*-hexane exposure in weanlings (21 days old) and young adults (80 days old) (Howd et al.1983), peripheral neuropathy occurred in both groups, although onset was more rapid in the young adult group. No deaths were observed over the 11-week exposure period and 3-week recovery period in weanling rats. In young adults, however, 5 of 10 rats died as the result of severe neuropathy. An oral LD₅₀ study showed 14-day-old rats were more susceptible to the acute effects of a large dose of *n*-hexane than young adults (Kimura et al.1970). LD₅₀ values for *n*-hexane were 15,840 mg/kg for 14-day-olds and 32,340 mg/kg for the young adults. Clinical signs and time to death were not reported. The Howd et al. (1983) study used relatively high concentrations of *n*-hexane (1,000 ppm) and should be repeated at lower levels (≥500 ppm) to determine if the differences in susceptibility still exist at levels to which humans are more likely to be exposed.

Data needs relating to development are discussed in detail above under Developmental Toxicity.

2. HEALTH EFFECTS

There is no experimental evidence available to assess whether the toxicokinetics of *n*-hexane differ between children and adults. Experiments in the rat model comparing kinetic parameters in weanling and mature animals after exposure to *n*-hexane would be useful. These experiments should be designed to determine the concentration-time dependence (area under the curve) for blood levels of the neurotoxic *n*-hexane metabolite 2,5-hexanedione. *n*-Hexane and its metabolites cross the placenta in the rat (Bus et al.1979); however, no preferential distribution to the fetus was observed. *n*-Hexane has been detected, but not quantified, in human breast milk (Pellizzari et al.1982), and a milk/blood partition coefficient of 2.10 has been determined experimentally in humans (Fisher et al.1997). However, no pharmacokinetic experiments are available to confirm that *n*-hexane or its metabolites are actually transferred to breast milk. Based on studies in humans, it appears unlikely that significant amounts of *n*-hexane would be stored in human tissues at likely levels of exposure, so it is unlikely that maternal stores would be released upon pregnancy or lactation. A PBPK model is available for the transfer of *n*-hexane from milk to a nursing infant (Fisher et al.1997); the model predicted that *n*-hexane intake by a nursing infant whose mother was exposed to 50 ppm at work would be well below the EPA advisory level for a 10-kg infant. However, this model cannot be validated without data on *n*-hexane content in milk under known exposure conditions.

There is no experimental evidence adequate to evaluate whether metabolism of *n*-hexane is different in children. Similarly, there is no information available from animal experiments. The initial step in *n*-hexane metabolism in animals is a hydroxylation step catalyzed by a P-450 enzyme. Since some of these enzymes are developmentally regulated, it would be of interest to know: (1) if there are specific P-450 isozymes involved in *n*-hexane hydroxylation and, (2) if so, are these isozymes known to be developmentally regulated?

Due to the lack of reports of *n*-hexane toxicity in children (except a few case reports of teenagers) there is no data available as to whether children differ in their susceptibility to *n*-hexane toxicity compared to adults. Weanling rats (21 days old) were more resistant to the development of *n*-hexane peripheral neuropathy than young adults (80 days old) during an exposure to 1,000 ppm *n*-hexane (Howd et al.1983). The authors suggested that the relative resistance of the weanling rats may have been due to shorter, smaller-diameter axons, or to a greater rate of growth and repair in their peripheral nerves compared to those of adults. While this is a plausible explanation for the results in rats, it would be speculative to predict on this basis that children would be less sensitive than adults. If cases of clinical *n*-hexane neurotoxicity occur in the future in adults in a setting where children are likely to have been exposed (e.g. home use of *n*-hexane containing products) thorough neurological and electrophysiological examinations

2. HEALTH EFFECTS

should be performed on the children. Additionally, both immediate and long-term health effects caused by *n*-hexane in neonatal and juvenile animals could be investigated, possibly in some of the same studies examining postnatal exposures and developmental effects which are discussed in a previous data needs section.

Child health data needs relating to exposure are discussed in Section 5.8.1, Data Needs: Exposures of Children.

2.11.3 Ongoing Studies

Dr. Doyle Graham of Vanderbilt University is conducting a series of mechanistic investigations on *n*-hexane neurotoxicity (FEDRIP 1996). The specific aims are:

- (1) to determine the specificity and generality of the gamma-diketone structure in the genesis of the neurotoxicity of alkanes;
- (2) to define the mechanism of pyrrole synthesis and the relationship between the rate of pyrrole formation and neurotoxicity;
- (3) to determine whether pyrrole autoxidation and crosslinking are necessary steps in the pathogenetic sequence;
- (4) to determine the structure of the crosslinking adducts;
- (5) to determine whether neurofilamentous crosslinking is progressive during chronic intoxication;
- (6) to determine the role of axonal constrictions at nodes of Ranvier in the development of axonal swellings;
- (7) to determine the mechanism of degeneration of the distal axon; and
- (8) to determine what steps in the proposed pathogenetic scheme for *n*-hexane neurotoxicity have parallels in the pathogenesis of the neuropathies caused by beta,beta'-iminodipropionitrile, carbon disulfide and acrylamide.

3. CHEMICAL AND PHYSICAL INFORMATION

3.1 CHEMICAL IDENTITY

n-Hexane is a very volatile aliphatic hydrocarbon. It is a constituent in the paraffin fraction of crude oil and natural gas and is also used as an industrial chemical and laboratory reagent. Laboratory grade *n*-hexane contains approximately 99% *n*-hexane. "Hexane" or "hexanes" is a commercial and industrial product consisting of a mixture of hydrocarbons with six carbon atoms and includes *n*-hexane and its isomers 2-methylpentane and 3-methylpentane as well as small amounts of other hydrocarbons (Brugnone et al.1991). Laboratory and industrial solvents such as "hexane" and petroleum ether contain *n*-hexane from <0.1% to as much as 33% (Creaser et al.1983). Information regarding the chemical identity of *n*-hexane is located in Table 3-1.

Many commercial grades of *n*-hexane contain appreciable amounts of other hydrocarbons in addition to *n*-hexane (for instance, toluene or such solvents as acetone or methyl ethyl ketone; see below for other chemicals in such mixtures). Various types of commercial grades of *n*-hexane are available, and the constituents besides *n*-hexane are usually an intentional part of the process for preparing these commercial mixtures. Where intended for specialized oil extraction or laboratory uses, the purity of the *n*-hexane products may be in the range of 95-99% *n*-hexane; for a variety of uses where purity is not as important, commercial *n*-hexane mixtures (in the range of 20-80% of *n*-hexane) may contain small amounts of chemicals such as acetone, methyl ethyl ketone, dichloromethane, and trichloroethylene, aromatics such as toluene, and other types of petroleum hydrocarbons (Jorgensen and Chor 1981; Takeuchi et al.1993). In commercial grades of *n*-hexane, some of the constituents are purposefully added as denaturants, often to discourage the abuse of the chemical to induce "highs" through sniffing or inhalation (Altenkirch et al. 1982).

3.2 PHYSICAL AND CHEMICAL PROPERTIES

The National Fire Protection Association (NFPA) has assigned *n*-hexane a health hazard identification code of 1 (slight) and flammability code of 3 (serious) (NFPA 1994). *n*-Hexane is flammable and may be ignited by heat, sparks, and flames. Flammable vapor may spread away from a spill. The vapor may be an explosion hazard. *n*-Hexane can react vigorously with oxidizing materials such as liquid chlorine, concentrated oxygen, and sodium hypochlorite. *n*-Hexane will attack some forms of plastics, rubber, and coatings. Information regarding the physical and chemical properties of hexane is located in Table 3-2.

3. CHEMICAL AND PHYSICAL INFORMATION

Table 3-1. Chemical Identity of *n*-Hexane

Characteristic	Information	Reference
Chemical name	<i>n</i> -Hexane	Merck 1989
Synonym(s)	Hexane Hexyl hydride	HSDB 1996 NFPA 1994
Registered trade name(s)	Skellysolve B Gettysolve-B	HSDB 1996 RTECS 1997
Chemical formula	C ₆ H ₁₄	Lide 1994
Chemical structure	CH ₃ CH ₂ CH ₂ CH ₂ CH ₂ CH ₃	
Identification numbers:		
CAS Registry	110-54-3	ASTER 1995
NIOSH RTECS	MN9275000	RTECS 1997
EPA Hazardous Waste	No data	
OHM/TADS	No data	
DOT/UN/NA/IMCO	UN 1208; IMO 3.1	HSDB 1996
HSDB	91	HSDB 1996
NCI	C60571	HSDB 1996

CAS = Chemical Abstracts Services; DOT/UN/NA/IMCO = Department of Transportation/United Nations/North America/International Maritime Dangerous Goods Code; EPA = Environmental Protection Agency; HSDB = Hazardous Substance Data Bank; NCI = National Cancer Institute; NIOSH = National Institute for Occupational Safety and Health; OHM/TADS = Oil and Hazardous Materials/Technical Assistance Data System; RTECS = Registry of Toxic Effects of Chemical Substances

3. CHEMICAL AND PHYSICAL INFORMATION

Table 3-2. Physical and Chemical Properties of *n*-Hexane

Property	Information	Reference
Molecular weight	86.18	Lide 1994
Color	Colorless	Merck 1989
Physical state	Liquid	Merck 1989
Melting point	-95 °C	Lide 1994
Boiling point	69 °C	Lide 1994
Density	0.6603 at 20 °C	Lide 1994
Odor	Faint, peculiar odor	Merck 1989
Odor threshold:		
Water	0.0064 mg/L	Amoore and Hautala 1983
Air	130 ppm	Amoore and Hautala 1983
Solubility:		
Water	Insoluble 9.5 mg/L	Merck 1989 Chiou et al. 1988
Organic solvent(s)	Miscible with alcohol, chloroform, ether	Merck 1989
Partition coefficients:		
Log K_{ow}	3.290	SRC 1995
Log K_{oc}	2.90 3.10–3.61(est.)	Coates et al. 1985 HSDB 1996
Vapor pressure	150 mm Hg at 25 °C 138 mm Hg at 24 °C	HSDB 1996 Chiou et al. 1988
Henry's law constant: at 25 °C	1.69 atm·m ³ /mole	SRC 1994a
Autoignition temperature	225 °C	NFPA 1994
Flashpoint	-22 °C	NFPA 1994
Flammability limits at 25 °C	1.1–7.5 %	NFPA 1994
Conversion factors		
ppm to mg/m ³	1 mg/m ³ = 0.284 ppm	HSDB 1996
mg/m ³ to ppm	1 ppm = 3.52 mg/m ³	
Explosive limits	1.1–7.5%	WHO 1991

4. PRODUCTION, IMPORT/EXPORT, USE, AND DISPOSAL

4.1 PRODUCTION

Normal hexane (*n*-hexane) is both an anthropogenic and naturally occurring chemical. *n*-Hexane is a minor constituent of crude oil and natural gas. Its inclusion in a variety of petroleum products is a consequence of refining operations that separate hydrocarbons within specific ranges of boiling points for such uses as heating oils or automotive fuels. It may also be a metabolic byproduct from certain types of fungi (Ahearn et al.1996). Such sources of natural releases are discussed in Chapter 5. In commercial products prepared from the distillation of petroleum, *n*-hexane has many uses as a special-purpose solvent and oil extractant. In a highly purified form, *n*-hexane is used in chemical laboratories as an extractant for a wide range of hydrocarbons and nonpolar organic compounds.

Virtually all *n*-hexane is obtained from petroleum mixtures through controlled fractional distillation and other refinery-based processes (Speight 1991). *n*-Hexane can also be synthesized from sugar cane wastes using special catalysts (SUCRON 1996). This type of synthesis is relatively new and the volume produced is still very limited. The presence of many types of hydrocarbon impurities in many commercial grades of *n*-hexane, combined with the intentional denaturing of *n*-hexane preparations to discourage substance abuse, make it difficult to establish odor thresholds for many products containing *n*-hexane.

Table 4-1 lists the facilities in each state that manufacture or process *n*-hexane, the intended use, and the range of maximum amounts of *n*-hexane that are stored on site. The data listed in Table 4-1 are derived from the Toxics Release Inventory (TRI96 1998). Only certain types of facilities were required to report. Therefore, this is not an exhaustive list. Based on the most current TRI information, there are currently 534 facilities that produce or process *n*-hexane in the United States.

The dual role of *n*-hexane as a component of refined petroleum fuels and as a highly refined, specialized product for other end uses lead to complications in making estimates of actual production levels. For instance, no formal production statistics could be identified associated with the *n*-hexane contained in heating or motor fuels. Since the late 1980s no quantitative production figures have been available for those companies documented as producing appreciable amounts of *n*-hexane for commercial use (SRI 1988, 1990, 1992, 1994, 1995, 1996). The following six facilities are currently documented as producers

4. PRODUCTION, IMPORT/EXPORT, USE, AND DISPOSAL

Table 4-1. Facilities That Manufacture or Process n-Hexane

STATE ^a	NUMBER OF FACILITIES	RANGE OF MAXIMUM AMOUNTS ON SITE IN POUNDS ^b	ACTIVITIES AND USES ^c
AK	2	1,000,000 - 9,999,999	1, 3, 4, 8
AL	15	1,000 - 49,999,999	1, 2, 3, 5, 6, 7, 8, 9, 11, 12, 13
AR	11	1,000 - 49,999,999	1, 2, 3, 7, 11, 12, 13
AZ	5	1,000 - 999,999	8, 11, 12
CA	39	100 - 99,999,999	1, 2, 3, 4, 5, 6, 7, 8, 9, 10, 11, 12, 13
CO	8	1,000 - 9,999,999	1, 4, 6, 8, 10, 11, 13
CT	4	1,000 - 99,999	8, 11, 13
DE	5	10,000 - 49,999,999	1, 2, 3, 7, 8, 11
FL	8	1,000 - 999,999	8, 11, 12
GA	21	1,000 - 9,999,999	1, 2, 3, 4, 6, 8, 9, 10, 11, 12, 13
HI	2	100,000 - 9,999,999	1, 2, 6, 11
IA	20	1,000 - 999,999	11, 12, 13
IL	39	0 - 99,999,999	1, 2, 3, 4, 6, 7, 8, 9, 10, 11, 12, 13
IN	27	0 - 99,999,999	1, 3, 4, 7, 8, 9, 10, 11, 12, 13
KS	10	100 - 49,999,999	1, 3, 4, 8, 9, 10, 11, 12
KY	11	100 - 9,999,999	1, 3, 4, 6, 7, 9, 10, 11, 12, 13
LA	40	1,000 - 1E12	1, 2, 3, 4, 5, 6, 7, 8, 9, 10, 11, 12, 13
MA	16	1,000 - 999,999	2, 3, 8, 10, 11, 12
MD	3	10,000 - 99,999	8, 11, 13
ME	2	1,000 - 999,999	1, 6, 12
MI	28	100 - 9,999,999	1, 2, 3, 4, 7, 8, 9, 10, 11, 12, 13
MN	20	1,000 - 49,999,999	1, 4, 5, 7, 8, 10, 11, 12, 13
MO	17	1,000 - 999,999	8, 9, 10, 11, 12, 13
MS	14	0 - 9,999,999	1, 3, 6, 7, 8, 11, 12, 13
MT	6	10,000 - 49,999,999	1, 2, 3, 4, 6, 7, 8, 9, 11
NC	15	100 - 999,999	1, 5, 8, 9, 11, 12, 13
ND	4	100,000 - 49,999,999	1, 2, 3, 4, 7, 11
NE	9	1,000 - 999,999	11, 12
NJ	17	1,000 - 99,999,999	1, 2, 3, 4, 7, 8, 9, 10, 11, 12
NM	4	100,000 - 9,999,999	1, 3, 4, 6, 7, 8, 9, 13
NV	2	10,000 - 999,999	8, 11
NY	7	1,000 - 999,999	1, 5, 8, 11, 12, 13
OH	58	0 - 49,999,999	1, 2, 3, 6, 7, 8, 9, 10, 11, 12, 13
OK	9	1,000 - 99,999,999	1, 3, 4, 5, 6, 7, 8, 9, 11, 12, 13
OR	1	10,000,000 - 49,999,999	10
PA	20	1,000 - 49,999,999	1, 2, 3, 5, 6, 7, 8, 9, 11, 12, 13
PR	15	1,000 - 499,999,999	1, 2, 4, 5, 6, 8, 10, 11, 12, 13
RI	1	1,000 - 9,999	2, 3, 8, 13
SC	11	0 - 999,999	1, 5, 6, 8, 9, 11, 12, 13
SD	2	10,000 - 999,999	11, 12
TN	18	1,000 - 9,999,999	1, 2, 5, 6, 8, 9, 11, 12, 13
TX	121	0 - 1E12	1, 2, 3, 4, 5, 6, 7, 8, 9, 10, 11, 12, 13
UT	10	0 - 49,999,999	1, 2, 3, 4, 7, 8, 9, 11, 12, 13
VA	16	1,000 - 999,999	1, 3, 5, 6, 7, 8, 9, 10, 11, 12, 13
VI	1	50,000,000 - 99,999,999	1, 2, 3, 4, 7, 11
WA	9	1,000 - 99,999,999	1, 2, 3, 4, 5, 6, 7, 8, 10, 11, 12, 13
WI	10	1,000 - 99,999	1, 6, 8, 10, 11, 12, 13
WV	5	1,000 - 99,999	11, 12, 13
WY	5	100,000 - 49,999,999	1, 3, 4, 5, 6, 7, 8

Source: TRI96 1998

^a Post office state abbreviations used

^b Range represents maximum amounts on site reported by facilities in each state

^c Activities/Uses:

- | | | |
|--------------------------|--------------------------|-----------------------------|
| 1. Produce | 6. Impurity | 11. Chemical Processing Aid |
| 2. Import | 7. Reactant | 12. Manufacturing Aid |
| 3. Onsite use/processing | 8. Formulation Component | 13. Ancillary/Other Uses |
| 4. Sale/Distribution | 9. Article Component | |
| 5. Byproduct | 10. Repackaging | |

4. PRODUCTION, IMPORT/EXPORT, USE, AND DISPOSAL

of *n*-hexane: Exxon Chemical Company, Baytown, Texas; Humphrey Chemical Company, Inc. (formerly the Cambrex Corporation), North Haven, Connecticut; Phibro Energy USA, Inc., Houston Texas; Phillips Petroleum Company's Olefins and Cyclics Branch, Sweeny, Texas; Phillips Petroleum Company's Specialty Chemicals Branch, Borger, Texas; and the UNI-VEN Company (formerly the Unocal Corporation), Lemont, Texas (SRI 1996). During the period 1988 to 95, the following five additional facilities were also documented as producing *n*-hexane: Independent Refining Company, Winnie, Texas; Pennzoil Company Atlas Refinery, Shreveport, Louisiana; Unocal Corporation, Beaumont, Texas; Texaco, Inc., El Dorado, Kansas; and South Hampton Refining Company, Silsbee, Texas (SRI 1990, 1992, 1994, 1995). The available information suggests that many facilities are capable of entering the market for *n*-hexane production through minor alterations in their refining operations when there is strong demand. Information from the mid-1970s suggests commercial production levels for *n*-hexane were approximately 358,341,000 pounds (143 million kg) (Marks et al.1980). For 1992, production was estimated at approximately 151 million kg (USITC 1994).

4.2 IMPORT/EXPORT

No current information concerning the import or export of *n*-hexane in the United States was located in the Literature.

4.3 USE

n-Hexane is used mainly as an edible-oil extractant for a variety of seed crops such as soybeans, cottonseed, rape seed (canola), flax (linseed), mustard seed, peanuts, safflower seed, and corn germ, which are then processed into foods for humans or livestock (Bhagya and Srinivas 1992; Conkerton et al.1995; Dominquez et al.1995; Kim and Yoon 1990; Lawson 1995; Srinivas et al.1992; Wanasundara and Shahidi 1994). While other petroleum-derived solvents (e.g., pentane) or other organic solvents (e.g., chloroform, methanol, ethanol, or ammonia-alcohol mixtures) are currently being studied or are used for certain processes, *n*-hexane has been widely used since the early part of this century, especially with soybeans, cottonseed, and linseed (Conkerton et al.1995). Part of *n*-hexane's appeal relates to aesthetic properties such as preserving the colors of the original plant materials. Different extractant mixtures can also have significant effects on the levels of materials that can cause bitter tastes (e.g., tannins) and on the degree to which certain flatulence-causing sugars are removed. While other solvents could be used in the initial oil extraction phases, several decades of experience in combining the oil-extraction steps with other

4. PRODUCTION, IMPORT/EXPORT, USE, AND DISPOSAL

procedures to preserve desirable colors and eliminate unwanted tastes or other undesirable food properties have worked to maintain a heavy reliance on *n*-hexane for edible-oil extraction (Lawson 1995). In the 1970s it was estimated that soybean oil extraction alone accounted for approximately 30% of all uses of *n*-hexane in the United States (HSDB 1996).

n-Hexane has other major uses as a special-purpose solvent and cleaning agent (degreaser) in such industries as textile manufacture, shoe and leather making, and furniture manufacturing (Jorgensen and Chor 1981). It is used in the printing industry as a cleaner and as a component of some inks (EPA 1996c; Wadden et al.1995). Facilities that use rotogravure printers (facilities that produce catalogues, magazines, “glossy” newspaper inserts, or telephone directories) or similar rotogravure or flexographic technologies (for labels, gift wrap, metal foils, flexible packaging materials, and some floor coverings) also use *n*-hexane (EPA 1996c). While not used in most glues or epoxy cements (Rastogi 1993), *n*-hexane is the solvent used in “rubber” cement (also known as gum adhesive) widely used in schools and libraries and by artists (McCann 1992). Various glues, adhesives, and leather-dressing preparations, especially those used in assembling shoes, may contain *n*-hexane (Cardona et al.1993; Periago et al.1993; Takeuchi et al.1993). In bookbinding and leather working, *n*-hexane, often mixed with other hydrocarbon solvents, is used as a carrier for cedar oil, beeswax, or lanolin dressings (Jorgensen and Chor 1981; Roberts and Etherington 1996). *n*-Hexane is used in some typeover correction (“white-out”) fluids (Ong et al.1993). It has been used in many types of non-mercury thermometers, especially for thermometers used in low temperature ranges (EPA 19948). It has been used as a denaturing agent in some alcohol preparations (HSDB 1996). New roofing materials using rubber or plastic films and membranes held together by adhesives, sealants, or hardening agents may contain *n*-hexane (Herbert et al.1995). It may be used as a carrier or aerosol (propellant) agent in some perfumes (Bouhamra 1995; Jorgensen and Chor 1981). It is used in the pharmaceutical industry to help shape pills and tablets, which are then dried to vent off the *n*-hexane before packaging (Jorgensen and Chor 1981). In the petrochemical industry, lighter alkane fractions including *n*-hexane may be used as feedstocks in the manufacture of polyethylene or polypropylene (Jorgensen and Chor 1981). In canning operations, the ends of tin cans are held in place with adhesives that commonly contain *n*-hexane (Bachmann et al.1993). The balls used in several sports (e.g., baseball) have cores wrapped with strings or yarns, which are often held in place with adhesives containing *n*-hexane (Huang et al.1991). In the manufacture of truck and automobile tires, *n*-hexane is a solvent in mixtures (called “thinners”) used to adjust the viscosity of the rubber while it is being polymerized and formed into tires (Jorgensen and Chor 1981; Van Ert et al.1980). *n*-Hexane is apparently in the adhesives for certain types of tapes, bandages, and dressings used in hospitals (Jorgensen and Chor 1981). Adhesives, cleaners, or

4. PRODUCTION, IMPORT/EXPORT, USE, AND DISPOSAL

lacquers containing *n*-hexane are also used to prepare the veneers used in making many types of furniture or ornamental boxes (Graham et al.1995).

Pure *n*-hexane is widely used in laboratories as an extractant for nonpolar compounds and in calibrating instruments for analyses of volatile organic compounds (VOC) or total petroleum hydrocarbons (TPH) (Kanatharana et al.1993). Since such analyses may require very high levels of purity, laboratories sometimes carry out their own fractional distillation or other pretreatment-purification procedures to remove petroleum hydrocarbon impurities found in commercially available grades of *n*-hexane (Kanatharana et al.1993). See Chapter 6 for more information about testing for *n*-hexane.

Finally, *n*-hexane may be a component of many types of commercial preparations or in mixtures produced in small batches *on-site* such as paint thinners, general-purpose solvents, degreasing agents, or cleaners. For instance, until the 1970s naphtha, a mixture with a high *n*-hexane content, was widely used as a dry cleaning agent. Since the early 1900s construction workers, metal workers, janitors, furniture workers, motor-vehicle mechanics, and print-shop workers have used these general-purpose mixtures. Such mixtures have also been used extensively for home repair and hobby projects. These mixtures have wide variations in their compositions but often contain up to 20% *n*-hexane even when the main components are other petroleum alkane fractions (e.g., kerosene), aromatic hydrocarbons (e.g., toluene), chlorinated hydrocarbon solvents, or other organic liquids (Farmer 1996; Veulemans et al.1987).

4.4 DISPOSAL

Limited information was located in the literature concerning the disposal of *n*-hexane. Since it is highly flammable, *n*-hexane, or mixtures with significant amounts of *n*-hexane, are regulated under the Resource Conservation and Recovery Act (RCRA) disposal procedures covering D001 wastes for ignitable wastes and petroleum solvents. For printing operations it could also be considered under the K086 ink sludges designation (EPA 1996c). *n*-Hexane is listed as a toxic substance under Section 313 of the Emergency Planning and Community Right to Know Act (EPCRA) under Title III of the Superfund Amendments and Reauthorization Act (SARA) (EPA 1993a). It is also listed as a Hazardous Air Pollutant (HAP) in the Clean Air Act Amendments of 1990 (EPA 1994g). Disposal of wastes containing *n*-hexane is controlled by a number of federal regulations (see Chapter 7).

5. POTENTIAL FOR HUMAN EXPOSURE

5.1 OVERVIEW

n-Hexane is a highly volatile component of the paraffin (also the alkane or aliphatic) fraction of crude oil and natural gas, and it is a constituent of heating and motor fuels refined from petroleum. Exposure from contact with vapors or emissions from these refined petroleum products is the most widespread form of low-level exposure for the general population. Most *n*-hexane in these fuels is oxidized (and therefore destroyed) as part of the combustion process to provide heat or drive internal combustion engines. Small amounts of *n*-hexane, along with other petroleum compounds, volatilize to the atmosphere during handling, storage in fuel tanks, or through incomplete combustion. Recent research (Ahearn et al.1996) suggests that certain fungi may be able to produce *n*-hexane. These fungi may be common in older buildings, and in some parts of the country may provide exposures from previously unsuspected indoor sources. *n*-Hexane is also produced as a relatively pure product for a number of specialized end uses, primarily as a solvent or as a component of certain glues and adhesives. Especially in urban areas, *n*-hexane may be a typical component of nonpoint source runoff when rainfall washes hydrocarbons deposited on roads and other surfaces into surface waters. Spills of refined petroleum products or of commercial *n*-hexane products may introduce *n*-hexane into soils or surface waters. Around urbanized areas, spill sites, refineries, tank storage facilities, underground storage tanks (e.g., at gas stations), or waste sites, can be sources of *n*-hexane subsequently transported into sediments or groundwater. Once introduced into deeper sediments or groundwater, *n*-hexane may be fairly persistent since its degradation by chemical hydrolysis is slow and opportunities for biodegradation may be limited under anoxic conditions or where nutrients such as nitrogen or phosphorus are in limited supply. In the atmosphere, the main degradation pathways involve destruction through the action of free radicals such as hydroxyl radicals.

n-Hexane has been identified in at least 60 of the 1,467 current or former EPA National Priorities List (NPL) hazardous waste sites (HazDat 1998). However, the number of sites evaluated for *n*-hexane is not known. The number of these sites within the United States can be seen in Figure 5-1.

5.2 RELEASES TO THE ENVIRONMENT

According to the Toxics Release Inventory (TRI), in 1996, a total of 70,685,942 pounds (32,062,933 kg) of *n*-hexane was released to the environment from 534 reporting facilities (TRI96 1998). Table 5-1 lists amounts released from these facilities. An estimated 77,303 pounds (35,064 kg) was released to publicly owned treatment works (POTWs), and an estimated 11,625,623 pounds (5,273,348 kg) were transferred

Figure 5-1. Frequency of NPL Sites with n-Hexane Contamination

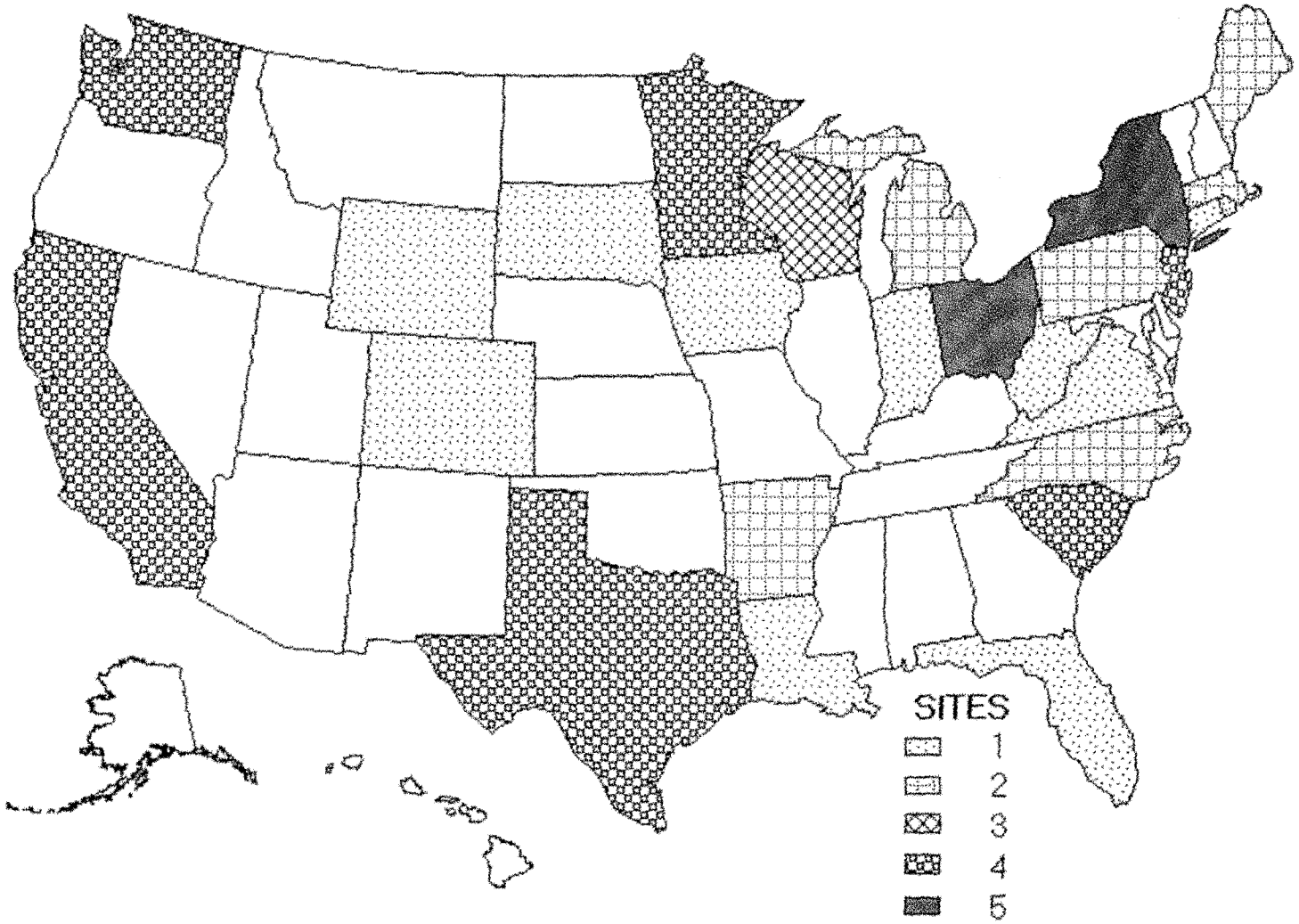

Derived from HazDat 1998

Table 5-1. Releases to the Environment from Facilities That Manufacture or Process n-Hexane

Total of reported amounts released in pounds per year ^a								
STATE ^b	NUMBER OF FACILITIES	AIR ^c	WATER	LAND	UNDERGROUND INJECTION	POTW TRANSFER	OFF-SITE WASTE TRANSFER	TOTAL ENVIRONMENT ^d
AK	2	39,731	1	1,083	0	0	10	40,825
AL	15	1,570,973	0	0	0	100	97,240	1,668,313
AR	11	3,255,048	14,000	0	0	1,270	215	3,270,533
AZ	5	457,905	0	0	0	0	2,590	460,495
CA	40	1,114,984	0	0	0	250	144,952	1,260,186
CO	8	75,530	0	0	0	6	677,840	753,376
CT	4	122,187	5	0	0	1,300	99,225	222,717
DE	5	597,216	0	0	0	0	197,774	794,990
FL	8	253,743	0	0	0	755	115,998	370,496
GA	21	2,114,708	88	0	0	1,005	1,177,199	3,293,000
HI	2	31,493	250	500	0	0	755	32,998
IA	20	5,589,135	1,030	250	0	6,250	0	5,596,665
IL	39	10,331,776	1,847	659	0	14,852	196,088	10,545,222
IN	27	2,930,266	711	105	0	1,832	45,054	2,977,968
KS	10	2,165,816	11	0	0	1,077	291	2,167,195
KY	11	2,591,748	182	1,264	0	5	66,923	2,660,122
LA	40	4,216,364	3,393	11,026	101,329	11,000	1,301,515	5,644,627
MA	16	382,813	0	0	0	0	131,098	513,911
MD	3	358,760	0	0	0	5	1,761	360,526
ME	2	330,383	0	0	0	0	5,641	336,024
MI	28	713,270	0	0	250	2,430	4,928,420	5,644,370
MN	20	2,669,819	9	250	0	1,720	19,974	2,691,772
MO	17	2,733,991	0	0	0	1,255	57,656	2,792,902
MS	14	2,082,110	42,022	2	0	3	12,985	2,137,122
MT	6	413,150	6	255	0	0	0	413,411
NC	15	3,956,978	0	0	0	1,752	287,859	4,246,589
ND	4	510,343	0	0	0	6,267	0	516,610
NE	9	1,304,952	0	0	0	1,878	3,411	1,310,241
NJ	16	184,860	255	0	0	4	286,054	471,173
NM	4	133,844	0	0	0	0	300	134,144
NV	2	43,077	0	0	0	0	0	43,077
NY	7	38,759	0	0	0	0	30,128	68,887
OH	57	2,793,928	0	162	0	1,633	1,351,350	4,147,073
OK	9	942,993	33	84	0	250	827	944,187

Table 5-1. Releases to the Environment from Facilities That Manufacture or Process n-Hexane (continued)

Total of reported amounts released in pounds per year ^a								
STATE ^b	NUMBER OF FACILITIES	AIR ^c	WATER	LAND	UNDERGROUND INJECTION	POTW TRANSFER	OFF-SITE WASTE TRANSFER	TOTAL ENVIRONMENT ^d
OR	1	28,631	0	0	0	478	159	29,268
PA	20	486,136	258	35	0	26	286,345	772,800
PR	15	271,021	151,133	0	0	14,900	62,885	499,939
RI	1	4	0	0	0	0	0	4
SC	11	811,042	541	500	0	5,000	35,101	852,184
SD	2	280,000	0	0	0	0	4,469	284,469
TN	18	2,197,647	0	0	0	2,006	223,040	2,422,693
TX	121	9,726,651	1,779	6,429	0	6,818	16,968,300	26,709,977
UT	10	97,391	0	321	0	0	5	97,717
VA	16	964,473	0	0	0	750	215,848	1,181,071
VI	1	180,829	72	0	0	0	0	180,901
WA	9	273,954	559	6	0	5	5,805	280,329
WI	10	118,443	0	0	0	15	37,713	156,171
WV	5	52,711	0	0	0	0	28,901	81,612
WY	5	168,321	10	975	0	0	243	169,549

Source: TRI96 1998

^a Data in TRI are maximum amounts released by each facility^b Post office state abbreviations used^c The sum of fugitive and stack releases are included in releases to air by a given facility^d The sum of all releases of the chemical to air, land, and water, and underground injection wells; and transfers off-site by a given facility

POTW = publicly owned treatment works

5. POTENTIAL FOR HUMAN EXPOSURE

offsite (TRI96 1998). The TRI data should be used with caution because only certain types of facilities are required to report. This is not an exhaustive list.

Since *n*-hexane is a component of refined petroleum products, there is considerable potential for releases to environmental media through the use of heating and motor fuels. Table 5-2 summarizes the uses of petroleum products according to major demand categories (e.g., “transportation”) and displays estimated use levels in barrels (and liter equivalents) and by percentages for the various end-use demands for specific fuel types (e.g., kerosene or fuel oil). While *n*-hexane can be a minor constituent (less than 1% by weight) of several of these petroleum products, its physical properties as a light alkane make it most suitable for use in gasoline. Approximately 98% of the demand for gasoline involves transportation, mainly cars and trucks. The composition of gasolines has changed over the years, mainly in an effort to maintain the so called octane ratings of the fuels. Since the 1980s the growing use of nonleaded gasolines has led to a growing percentage of high-octane benzene and toluene in gasoline blends. For modern gasoline mixtures, the total percentage by weight of the *n*-hexane component is approximately 3% (Brugnone et al.1991; Heath et al.1993; Stelljes and Watkin 1993). Of the 2,608 million barrels of motor gasoline consumed for transportation in 1992 (designated “transportation” in Table 5-2) about 27,300 million pounds (12,409 million kg) are from the *n*-hexane fraction (PennWell 1994; Stevens 1988). This figure is about 76 times the 358 million pounds (143 million kg) of commercial *n*-hexane produced annually in the 1970s (Marks et al.1980). Most gasoline, along with its *n*-hexane fraction, is consumed during its combustion in motor cars and other engines. However, gasoline use results in a variety of emission losses from refueling, evaporation while gasoline is stored in fuel tanks or ignition systems, and exhaust releases when there is incomplete combustion of fuels (EPA 1994h). EPA only tracks trends in total hydrocarbon or total volatile organic compound (VOC) emissions, so that quantitative estimates for the *n*-hexane released from automobiles and trucks are not available. Assuming that only 1% of the *n*-hexane of motor fuels is released to environmental media, such releases could be on the same order of magnitude as the total amount of relatively pure *n*-hexane associated with the major end-uses described in Chapter 4. In addition to emissions to the atmosphere, releases from heating and motor fuel uses to other environmental media are possible as a result of leaks and spills at refineries, pipelines, large tank batteries (or tank “farms”), above- and below-ground storage tanks, tanker trucks and railroad tanker cars, or from minor releases at garages or around homes and workplaces. Crude oil spills also result in the release of *n*-hexane to the air or other environmental media.

5. POTENTIAL FOR HUMAN EXPOSURE

Table 5-2. Demand Patterns for Major Petroleum Products (1992)^a

Product	Residential	Commercial	Industrial	Transportation	Electric utilities	Total
Motor gasoline ^b	0 (0.0) 0	15 (<1.0) 2,385	37 (1.4) 5,883	2608 (98.0) 414,672	0 (0.0) 0	2,660
Kerosene	11 (73.3) 1,749	2 (13.3) 318	2 (13.3) 318	0 (0.0) 0	0 (0.0) 0	15
Distillate fuel oil	148 (13.6) 23,532	80 (7.3) 12,720	196 (18.0) 31,164	654 (60.0) 103,986	12 (1.1) 1,908	1,090
Residual fuel oil	0 (0.0) 0	30 (7.5) 4,770	62 (15.5) 9,858	172 (42.9) 27,348	136 (33.9) 21,942	400
Liquid petroleum gas and ethanes	106 (16.5) 16,858	19 (3.0) 3,021	513 (79.9) 81,567	5 (0.8) 795	0 (0.0) 0	643

^a Top line: millions of barrels (% of total sectoral demand)
Bottom line: millions of liters

^b Typically contains >1% *n*-hexane

Note: 1 barrel = 42 U.S. gallons = 159 liters

Source: PennWell 1994

5. POTENTIAL FOR HUMAN EXPOSURE

In addition to releases associated with the ordinary use of refined petroleum products as a fuel, ongoing research (Ahearn et al. 1996) suggests that a variety of fungi found in ducts and insulation materials in homes or office buildings are capable of releasing gases that include *n*-hexane.

Where the buildings have poor ventilation properties, commonly referred to as “sick-building syndrome” (Sundell 1996), the indoor air releases of *n*-hexane may sometimes be sufficient to pose public health concerns. *n*-Hexane is also among the various off-gassing constituents encountered at sanitary landfills (Brosseau and Heitz 1994; O’Leary and Walsh 1995). There is also evidence (McKay et al. 1996) that marine phytoplankton produce a variety of non-methane hydrocarbons, including small amounts of *n*-hexane, from the metabolism of polyunsaturated lipids in dissolved organic materials. Very small amounts of *n*-hexane may also be among the biogenic emissions from different types of terrestrial vegetation (Isidorov et al. 1985; Winer et al. 1992).

5.2.1 Air

According to the Toxics Release Inventory (TRI), in 1996, the estimated releases of *n*-hexane of 58,649,487 pounds (26,603,233 kg) to air from 534 reporting facilities accounted for about 82.9% of total environmental releases (TRI96 1998). Table 5-1 lists amounts released from these facilities. The TRI data should be used with caution because only certain types of facilities are required to report. This is not an exhaustive list.

Most releases of *n*-hexane to environmental media are to air. Based on its Henry’s law constant, *n*-hexane discharged to water will volatilize rapidly; however, the amount volatilized will vary depending on a number of factors including the temperature, turbulence, and depth of the receiving water. *n*-Hexane spilled onto surface soils will also volatilize to the air. Data sources were not identified allowing comprehensive quantitative estimates of the amount of *n*-hexane released on an annual basis to the air. In addition to releases from such commercial applications as edible oil extraction, the other major sources of atmospheric releases would be from emissions related to the *n*-hexane contained in heating and motor fuels.

n-Hexane was identified in air samples collected at 17 of the 60 NPL hazardous waste sites where it had been detected (HazDat 1998).

5. POTENTIAL FOR HUMAN EXPOSURE

5.2.2 Water

According to the Toxics Release Inventory (TRI), in 1996, the estimated releases of *n*-hexane of 215,775 pounds (97,875 kg) to water from reporting facilities accounted for less than 1 percent of total environmental releases (TRI96 1998). Table 5-1 lists amounts released from these facilities. The TRI data should be used with caution because only certain types of facilities are required to report. This is not an exhaustive list.

n-Hexane is probably released to water from a number of sources including industrial discharges, effluents from municipal waste-treatment plants, and nonpoint-source runoff from roads and other surfaces. Insufficient information is available to quantify the releases in a comprehensive fashion.

n-Hexane was identified in surface water at one site and in groundwater at 20 sites among the 60 NPL hazardous waste sites where it had been detected (HazDat 1998).

5.2.3 Soil

According to the Toxics Release Inventory (TRI), in 1996, the estimated releases of *n*-hexane of 16,175 pounds (7,337 kg) to soil from reporting facilities accounted for less than 1 percent of total environmental releases (TRI96 1998). Table 5-1 lists amounts released from these facilities. The TRI data should be used with caution because only certain types of facilities are required to report. This is not an exhaustive list.

n-Hexane is probably released to soil or sediments from spills and during the landfilling of sludges and other wastes generated from industrial processes and municipal sewage treatment; however, no specific quantitative information concerning release levels for *n*-hexane-containing wastes was located in the literature.

n-Hexane has been identified in soil samples collected at 14 and sediment samples collected at two of the 60 NPL hazardous waste sites where it was detected in some environmental media (HazDat 1998).

5. POTENTIAL FOR HUMAN EXPOSURE

5.3 ENVIRONMENTAL FATE

5.3.1 Transport and Partitioning

The physical properties of *n*-hexane (see Table 3-2) that affect its transport and partitioning in the environment are: water solubility of 9.5 mg/L; $\log[K_{ow}]$ (octanol/water partition coefficient), estimated as 3.29; Henry's law constant, 1.69 atm-m³ mol; vapor pressure, 150 mm Hg at 25 °C; and $\log[K_{oc}]$ in the range of 2.90 to 3.61. As with many alkanes, experimental methods for the estimation of the K_{oc} parameter are lacking, so that estimates must be made based on theoretical considerations (Montgomery 1991).

The dominant transport process from water is volatilization. Based on mathematical models developed by the EPA, the half-life for *n*-hexane in bodies of water with any degree of turbulent mixing (e.g., rivers) would be less than 3 hours. For standing bodies of water (e.g., small ponds), a half-life no longer than one week (6.8 days) is estimated (ASTER 1995; EPA 1987a). Based on the log octanol/water partition coefficient (i.e., $\log[K_{oc}]$) and the estimated log sorption coefficient (i.e., $\log[K_{oc}]$) (see Table 3-2) *n*-hexane is not expected to become concentrated in biota (Swann et al.1983). A calculated bioconcentration factor (BCF) of 453 for a fathead minnow (ASTER 1995) further suggests a low potential for *n*-hexane to bioconcentrate or bioaccumulate in trophic food chains.

In soil, the dominant transport mechanism for *n*-hexane present near the surface probably is volatilization (based on its Henry's law constant, water solubility, vapor pressure, and K_{oc}), but no experimental information focusing directly on *n*-hexane was found to confirm this assumption. While its estimated K_{oc} values suggest a moderate ability to sorb to soil particles, *n*-hexane has a density (0.6603 g/mL at 20 °C) well below that of water and a very low water solubility of 9.5 mg/L. *n*-Hexane would, therefore, be viewed as a light nonaqueous phase liquid (LNAPL), which would suggest a low potential for leaching into the lower soil depths since the *n*-hexane would tend to float on the top of the saturated zone of the water table (Feenstra et al.1991; Hunt et al.1988). Unless present in deeper soil layers (which can sometimes happen at waste sites or with underground storage tank leaks), *n*-hexane would generally stay near the soil surface and, if not appreciably sorbed into the soil matrix, would be expected eventually to volatilize to the atmosphere. Exceptions would involve locations with shallow groundwater tables where there were large spills of hexane products. In such cases, the *n*-hexane could spread out to contaminant a large volume of soil materials.

5. POTENTIAL FOR HUMAN EXPOSURE

5.3.2 Transformation and Degradation**5.3.2.1 Air**

n-Hexane does not absorb ultraviolet (UV) light at 290 nm and is thus not expected to undergo direct photolysis reactions. The dominant tropospheric removal mechanism for *n*-hexane is generally regarded to be decomposition by hydroxyl radicals (Atkinson and Carter 1984; Atkinson et al.1982). Calculations assuming typical hydroxyl radical concentrations suggest a half-life of approximately 2.9 days (SRC 1994b). While *n*-hexane can react with nitrogen oxides to produce ozone precursors under controlled laboratory conditions (Montgomery 1991), the smog-producing potential of *n*-hexane is very low compared to that of other alkanes or chlorinated VOCs (Kopczynski et al.1972). Hydroxyl ion reactions in the upper troposphere, therefore, are probably the primary mechanisms for *n*-hexane degradation in the atmosphere. As with most alkanes, *n*-hexane is resistant to hydrolysis (ASTER 1995; Lyman et al.1982). The proposed decomposition of *n*-hexane in air is shown in Figure 5-2.

5.3.2.2 Water

Although few data are available dealing explicitly with the biodegradation of *n*-hexane in water, neither hydrolysis nor biodegradation in surface waters appears to be rapid compared with volatilization. In surface waters, as in the atmosphere, alkanes such as *n*-hexane would be resistant to hydrolysis (ASTER 1995; Lyman et al.1982). Biodegradation is probably the most significant degradation mechanism in groundwater. One study was identified (McClay et al.1995) that documented the ability of *Pseudomonas mendocina* bacteria to metabolize *n*-hexane in laboratory microcosms simulating groundwater conditions. Mixed bacterial cultures as well as pure cultures are documented as capable of metabolizing *n*-hexane under aerobic conditions (Heringa et al.1961; Rosenberg et al.1992). A study of a biofiltration system to remove VOCs from air used a sludge-like composting biofiltering system that was effective in causing the biodegradation of *n*-hexane (Morgenroth et al.1996); this study involved a special composting system to allow the introduction of nitrogen fertilizers to overcome a nutrient limitation. Most of the available literature deals with petroleum mixtures containing several types of alkanes. In general, linear alkanes (such as *n*-hexane) are viewed as the most readily biodegradable fractions in petroleum (Leahy and Colwell 1990), particularly when oxygen is present in solution.

Figure 5-2. Degradation of *n*-Hexane in Air by Free Radicals

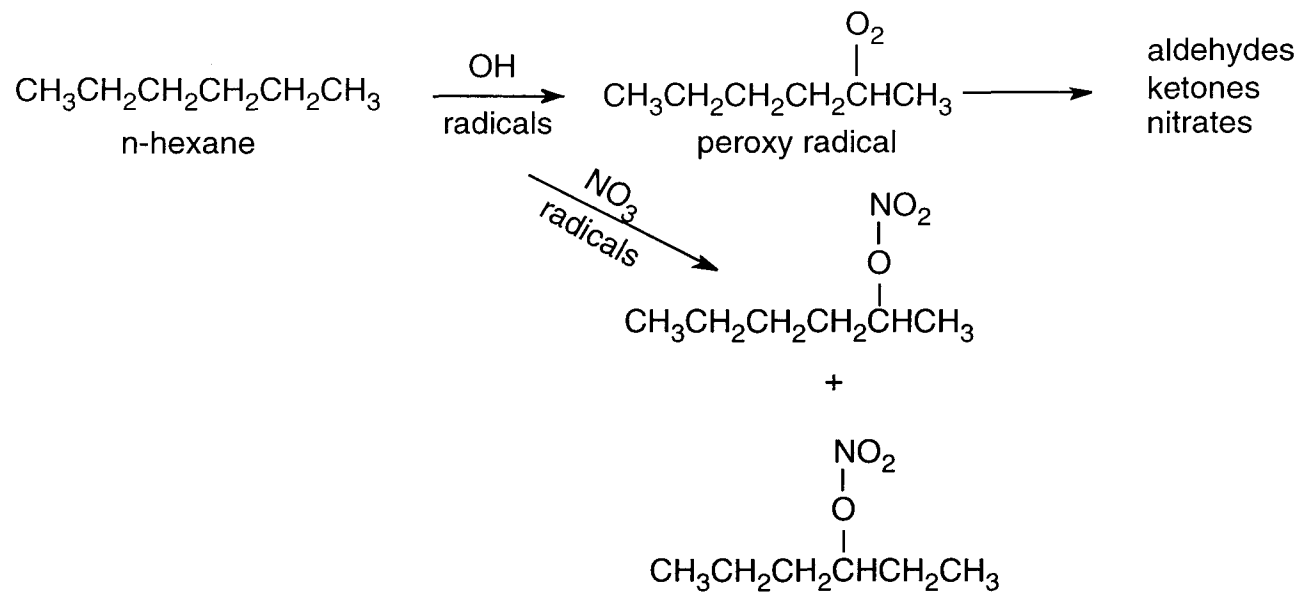

Source: Atkinson 1985

5. POTENTIAL FOR HUMAN EXPOSURE

Since *n*-hexane is highly volatile, it is often excluded from the list of constituents included in studies on biodegradation or bioremediation of petroleum wastes or in studies of surface waters receiving pollutant loads from runoff or discharges. Attention is generally focused on complex mixtures of hydrocarbons, starting with fractions heavier or less volatile (usually C10 or longer chain alkanes, aromatics such as benzene or toluene, and PAHs (polyaromatic hydrocarbons)) than the lighter constituents of gasoline (Crawford et al.1995; Latimer et al.1990; Rosenberg et al.1992; Sauer et al.1993; Shaw et al.1986). Once introduced into groundwater, *n*-hexane may be fairly persistent since its degradation by chemical hydrolysis is slow and opportunities for biodegradation may be limited under anoxic conditions or where nutrients such as nitrogen or phosphorus are in limited supply.

5.3.2.3 Sediment and Soil

The findings presented above in Section 5.3.2.2 on bioremediation in groundwater are relevant for many soil and sediment systems. Figure 5-3 outlines the probable biodegradation of *n*-hexane based on metabolites isolated from a pure culture of *Pseudomonas* (Heringa et al.1961). The most important biodegradation processes involve the conversion of the *n*-hexane to primary alcohols, aldehydes and, ultimately, into fatty acids. Similar processes are encountered with other light hydrocarbons such as heptane. In general, unless the *n*-hexane is buried at some depth within a soil or sediment, volatilization is generally assumed to occur at a much more rapid rate than chemical or biochemical degradation processes. Once introduced into deeper sediments, *n*-hexane may be fairly persistent since its degradation by chemical hydrolysis is slow and opportunities for biodegradation may be limited under anoxic conditions or where nutrients such as nitrogen or phosphorus are in limited supply.

5. 4 LEVELS MONITORED OR ESTIMATED IN THE ENVIRONMENT

The widespread use of *n*-hexane as an extractant in the laboratory creates problems in interpreting concentration readings at low levels. Even with good quality control, it may often be impossible to determine whether to attribute a measured value to the actual levels in a sample or to contamination from *n*-hexane in the laboratory environment (Otson et al.1994). For the most part, *n*-hexane is not a common target analyte from water or soil samples. While data based on ambient air samples or sampling in the air of various workplace or residential environments are more numerous, most EPA regulatory programs rely on bulk measurements of total hydrocarbons or total volatile compounds rather than on measurements of specific compounds such as *n*-hexane (Bishop et al.1994; DeLuchi 1993).

Figure 5-3. Aerobic Biodegradation of *n*-Hexane in Sediment and Soil

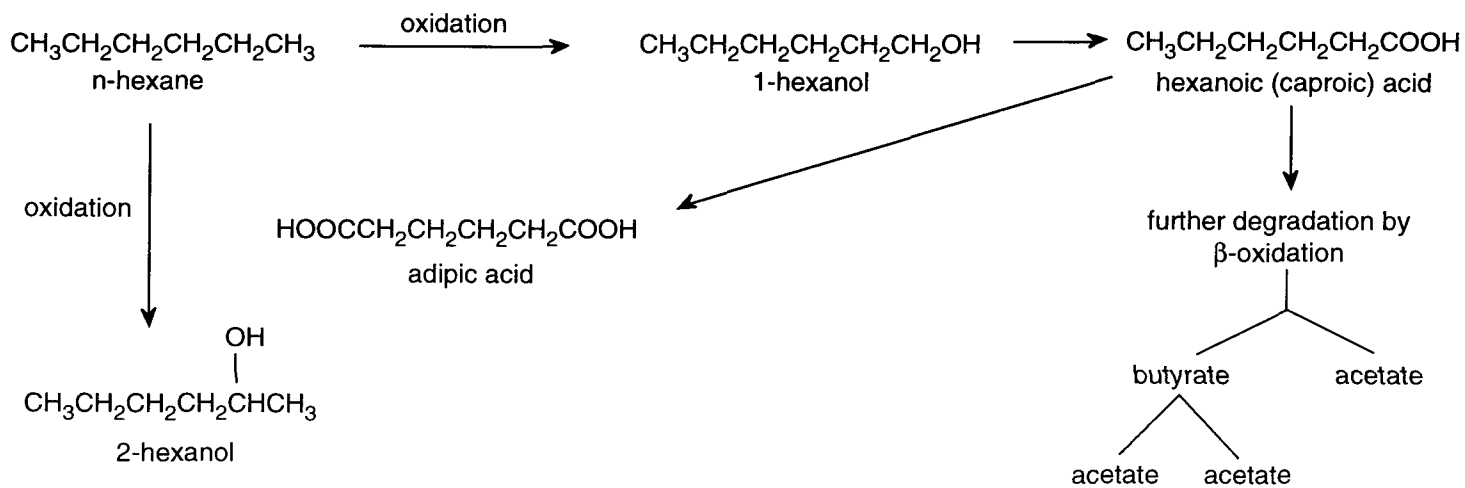

Source: Heringa et al. 1961

5. POTENTIAL FOR HUMAN EXPOSURE

5.4.1 Air

Concentrations of *n*-hexane in the air can be expressed as parts per million by volume (ppmv) or as mg/m³. For *n*-hexane, 1 ppmv = 3.52 mg/m³, and for lower concentrations, 1 part per billion volumetric (ppbv) = 3.52 µg/m³ (HSDB 1996). *n*-Hexane is found at low levels in both rural and urban ambient air, with concentrations generally well below 50 ppbv for ambient air. In remote sites, readings of less than 0.5 ppbv are typical. A study of four rural sites in southern Canada showed median ambient air concentrations of *n*-hexane in the range of 0.01 to 0.12 ppbv (Bottenheim and Shepherd 1995). Higher levels can be encountered in urban areas, largely due to emissions from automobile exhaust. In the polluted atmosphere of the Los Angeles central business district, ambient air concentrations as high as 25 ppbv were documented in the 1960s (Neligan 1962); these levels are very similar to the concentrations of *n*-hexane measured in automobile exhaust collected during the same time period. Samples from Los Angeles in 1968 showed *n*-hexane levels of 82 ppbv (Kopczynski et al. 1972). With progressive improvements in emission controls, the levels of many air pollutants in urbanized areas today are generally far lower. A recent study of average VOC concentrations in the ambient air of several large cities showed the following results for *n*-hexane: Vienna 2.2 ppbv; Hamburg 3.8 ppbv; Sydney 2.1 ppbv; Chicago 2.0 ppbv; Osaka 5.5 ppbv; and Athens 1.6 ppbv (Moschonas and Glavas 1996). Air samples from Kuwaiti houses after the Gulf War (which introduced large amounts of air pollutants from burning oil) showed average *n*-hexane levels of only 4.4 ppbv (Bouhamra 1995).

n-Hexane may be expected to comprise around 2% of the VOCs in urban air polluted with hydrocarbons from automobile emissions or other combustion byproducts (Barrefors and Petersson 1993). The *n*-hexane concentrations in urban air will typically be approximately 60% of the concentrations of benzene (Daisey et al. 1994). Close proximity to the exhaust systems of cars or other gasoline-powered vehicles can lead to exposures to increased concentrations of *n*-hexane. Under rush-hour conditions, the concentrations in the interior air of buses will tend to be lower (55 µg/m³ or 19.8 ppbv) than the interior levels in cars (69 µg/m³ or 24.9 ppbv) or the air around persons riding motorcycles (106 µg/m³ or 38.1 ppbv) (Chan et al. 1994). Transportation tunnels may contain hydrocarbon concentrations around six times the levels encountered with ordinary open-air vehicular traffic; this is probably associated with similarly elevated levels of *n*-hexane (Barrefors and Petersson 1993). Measurements of hydrocarbons from vehicular exhaust at the Fort McHenry Tunnel in Baltimore, Maryland, have shown *n*-hexane levels just under 60 ppbv (Zielinska et al. 1996). *n*-Hexane does not seem to be present in tobacco smoke, although such smoke can lead to elevations in the concentrations of other hydrocarbons in the air of interior rooms (Barrefors and Petersson

5. POTENTIAL FOR HUMAN EXPOSURE

1993). A complication in such testing is that hydrocarbons in the smoke may have been introduced from sources such as polluted urban air or *n*-hexane from cigarette lighters. The air in well ventilated office buildings in urban areas of California contained *n*-hexane levels of approximately $0.55 \mu\text{g}/\text{m}^3$ (1.5 ppbv) (Daisey et al.1994). Other studies of heavily polluted urban areas have suggested that the air in offices will have *n*-hexane levels at least an order of magnitude lower than the peak levels in rush-hour traffic in cars or other vehicles (Chan et al.1994); the same studies showing that the median concentrations averaged over an entire commuting trip are about the same as for the time-averaged median concentrations of *n*-hexane in office buildings ($<9 \mu\text{g}/\text{m}^3$ or <3.2 ppbv).

Recent research suggests that gases released by various fungi in ductwork, inner walls, and crawl spaces contain a variety of VOCs, including *n*-hexane (Ahearn et al.1996). Of the total levels of VOCs measured *in situ* from fungal-colonized insulation materials in a 2-year-old office building, *n*-hexane comprised about 2.69% of the total measured VOCs; in air samples collected under laboratory conditions using cultures prepared from fungal isolates, the *n*-hexane contribution to the total measured VOCs was 4.85% (Ahearn et al.1996). Measurements of the interior air of an office building located in the Houston area showed total VOC concentrations (expressed as carbon) in excess of 100 ppbv. The VOCs levels included detectable amounts of *n*-hexane as well as toluene and benzene (Ahearn et al.1996).

Concentrations in some workplace settings may be higher than typical ambient air levels. Samples collected in tire factories during the 1970s showed median *n*-hexane levels of 25.9 ppmv around the work area where the rubber curing took place (Van Ert et al.1980). When workers have assembled items in poorly ventilated rooms, *n*-hexane levels ranging from 500 to 2,500 ppmv have been documented (Iida 1982). Similar workplace findings, usually in countries other than the United States, have been documented, with *n*-hexane concentrations in workspace air in excess of 500 ppmv (Graham et al.1995). Elevated levels in air are also found in substance abuse cases, where pure *n*-hexane or mixtures containing significant amounts of *n*-hexane are used to produce a "high" (Altenkirch et al.1977; Graham et al.1995).

n-Hexane is a common trace component in landfill gases at many waste sites (Brosseau and Heitz 1994; O'Leary and Walsh 1995). The *n*-hexane concentrations of these emissions have been documented to range from 3 to $10 \text{ mg}/\text{m}^3$ (1.1-3.6 or 1,100-3,600 ppbv). While these levels would be expected to decrease rapidly as the landfill gases were dispersed into the ambient air, areas near the ground or pockets of air in trenches or excavations could reach levels significantly above the concentrations normally encountered in ambient air. For instance, data averaged over 15-minute intervals during site remediation

5. POTENTIAL FOR HUMAN EXPOSURE

work at a reclaimed oil refinery site showed levels as high as 121.51 mg/m³ (43.70 ppmv) in the air around a backhoe digging trench in the petroleum-contaminated soils (Verma et al.1992). Samples from the same study averaged over a typical 8-hour workshift for the area around the backhoe showed average levels of 3.06 mg/m³ (1.10 ppmv). Even higher levels (perhaps in excess of 10,000 ppmv) are possible around large spills of *n*-hexane; at such elevated concentrations, as with many components of gasoline-type hydrocarbons, there could be considerable danger from explosions, which are possible when the *n*-hexane levels exceed approximately 1.2% of the volume of air (Merck 1989). Since 0.1% by volume is equivalent to 1,000 ppmv, this flash-point level for *n*-hexane would be at a level of 12,000 ppmv or higher.

5.4.2 Water

In general, data on levels in water or groundwater are very limited, with no information being identified in the literature. Information on levels in public water supplies was not identified. Since *n*-hexane is highly volatile, typical treatment techniques for drinking water supplies in larger towns and cities would be expected to volatilize the *n*-hexane before it could enter the distribution system. It is likely that some *n*-hexane would be found in groundwater contaminated by gasoline leaks from underground storage tanks (UST). This could be a matter of concern for some domestic groundwater wells used for drinking water supplies. Since the emphasis in UST programs is usually on the more soluble aromatic fractions (e.g., benzene) or on bulk measurements of total petroleum hydrocarbons (TPH) (Potter 1993), no information could be identified in the literature dealing explicitly with *n*-hexane.

5.4.3 Sediment and Soil

Very little information could be identified dealing with *n*-hexane levels in sediments and soils. *n*-Hexane has been identified among the contaminants in an offsite oilfield-disposal pit in New Mexico (Eiceman et al. 1986). Since *n*-hexane is a trace constituent of crude oil and natural gas, as well as a component of refined petroleum products, soil or sediment contamination with *n*-hexane can be expected near oilfield production sites, large soil spills, slush pits and other areas around refineries, and in waste sites where petroleum products or other *n*-hexane-containing wastes had been disposed. Detections would also be likely near many tank storage facilities, pipelines, truck or rail transfer sites, car repair facilities, automobile assembly or storage facilities, and auto and truck fueling facilities (DeLuchi 1993).

5. POTENTIAL FOR HUMAN EXPOSURE

At many waste sites, *n*-hexane has been detected in the landfill gases vented from the soils at the disposal sites (Brosseau and Heitz 1994; O'Leary and Walsh 1995). While information in the literature is extremely limited, trace levels of *n*-hexane are probably found in the soils or the soil gases at many waste disposal sites. *n*-Hexane has been identified in the soil at 14 sites and in sediments at two sites among the 60 NPL hazardous waste sites where it was detected in some environmental medium (HazDat 1998).

5.4.4 Other Environmental Media

n-Hexane is exempted from analysis of most foodstuffs (the exceptions are spice oleoresins and corn endosperm oil) or as an inert ingredient in pesticide formulations (see Chapter 4; Firestone 1997). Testing for alkanes is often directed at compounds less volatile (e.g., C10 or higher) than *n*-hexane (Hernandez et al. 1995). There is, therefore, limited information in the literature on the levels of *n*-hexane encountered in foodstuffs. Analyses carried out in the 1960s and 1970s would have sometimes involved analytical methods not considered accurate by contemporary standards. Caution is also needed in interpreting published results to make sure the testing did not involve materials that had not yet gone through the complete cycle of solvent recovery, heating, and final vacuum treatment to recover the *n*-hexane solvent and remove as much as possible of this hydrocarbon from the final product intended for human consumption. Before these recovery processes, the crude oil or meal products can be expected to show appreciably high levels of *n*-hexane. In studies of fully processed edible oil products carried out in the 1960s it was determined that *n*-hexane residues were generally at levels below 10 ppm (Watts and Holswade 1967). Recent investigations using more precise modern analysis techniques (Hautfenne et al. 1987) concluded that residual *n*-hexane residues for refined food products would be less than 2 ppm. If the standard assumption of 80 g of fat consumed per 70-kg person per day is made, such residual levels would be the equivalent of no more than 2.29 µg/kg/day of *n*-hexane, which is a toxicologically insignificant amount.

No recent studies could be identified that were performed in the United States on levels in expired air. A study of hydrocarbon contents in expired air in the Chicago area carried out in the late 1970s found average *n*-hexane concentrations from 54 human volunteers breathing urban air to be approximately 4.7 ng/L (Krotoszynski et al. 1979). Most studies of *n*-hexane have involved occupational exposures, especially in shoe or sandal factories, in Japan or Italy. Since *n*-hexane is rapidly metabolized by humans to such compounds as 2,5-hexanedione, investigations of toxic substances in blood or urine typically focus on these metabolites (Mutti et al. 1993; van Engelen et al. 1995). In one study of shoe assembly workers in

5. POTENTIAL FOR HUMAN EXPOSURE

Italy, blood and urine levels of *n*-hexane were taken concurrently with readings of the *n*-hexane in workplace air and alveolar air. The median concentration for workplace (environmental air) was 87 ng/L; for alveolar air the median level was 26 ng/L; for blood samples the median concentration was 365 ng/L; and for urine samples the median was 549 ng/L (Brugnone et al.1991). Enough information has been assembled from ongoing studies from Italy (Brugnone et al.1994) to estimate typical levels in blood and urine from people in the general population living in rural areas as opposed to urban areas. For urine samples, the median value for the general population sampled in the rural areas was 401 ng/L; the median value for the urban areas was slightly higher at 550 ng/L; and the combined rural and urban median level was 492 ng/L (range, 24 to 1,608 ng/L). For blood samples, the rural median levels were 260 ng/L, and the urban general population levels were 287 ng/L. Special concomitant sampling for blood levels was also carried out for chemical plant workers, for whom the median blood levels were 729 ng/L. The pooled median blood levels (general rural population, plus general urban population, plus urban chemical workers) was 293 ng/L (range, 25 to 8,058 ng/L). In some workplace settings, median 8-hour-workshift levels in the air for *n*-hexane of 415 mg/m³ (1,154 ppmv) have been documented (Mutti et al.1993). In one study in the areas around Bayonne, New Jersey; Jersey City, New Jersey; Bridgeville, Pennsylvania; and Baton Rouge, Louisiana, *n*-hexane was detected (no concentrations reported) in samples of human breast milk (Pellizzari et al.1982).

n-Hexane is contained in a variety of products commonly used in household settings. Given its volatility, this creates possibilities for exposures from inhalation as well as by dermal contact and ingestion. In a study of over 1,000 common household products, *n*-hexane was detected in 101 products, about the same detection rate as for BTEX compounds (e.g., benzene, toluene, xylene or ethylbenzene) and other normal alkanes. *n*-Hexane was detected in more than 10% of the items sampled in the following product categories: automotive products; oils, greases and lubricants; and adhesive-related products (Sack et al. 1992).

5.5 GENERAL POPULATION AND OCCUPATIONAL EXPOSURE

Low-level exposures to *n*-hexane can possibly occur for much of the United States population, especially those that live in urban areas or those that commute in areas with heavy traffic, due to emissions of *n*-hexane associated with motor fuel use. As such, the general population will be exposed to very low levels at all times, while those living in urban centers may be exposed to slightly higher levels.

5. POTENTIAL FOR HUMAN EXPOSURE

Current empirically based estimates of exposures to *n*-hexane in various occupations are lacking. Some insights can be gleaned from the National Institute for Occupational Safety and Health's (NIOSH) National Occupational Hazard Survey (NOHS), a database (the NOHS database is also called the National Occupational Exposure Survey or NOES database) that estimates potentially exposed workers in a variety of manufacturing jobs (Sieber et al. 1991). Based on conditions typical of the mid-1970s it was estimated that 643,120 workers had potential exposures to *n*-hexane (NOES 1991). Occupations with 5,000 or more workers with potential exposure risks included the following: shoe and footwear assembly workers; hospital staff and laboratory technicians; workers operating or repairing typesetting and printing machinery; construction workers, carpet layers and carpenters; auto mechanics; workers in plants manufacturing tires or inner tubes; and workers in air transport and air-freight operations. The NOES database covers only certain manufacturing sector occupations and does not include workers at edible-oil extraction facilities, who are usually classified as agricultural workers.

5.6 EXPOSURES OF CHILDREN

This section focuses on exposures from conception to maturity at 18 years in humans and briefly considers potential pre-conception exposure to germ cells. Differences from adults in susceptibility to hazardous substances are discussed in Section 2.6, Children's Susceptibility.

Children are not small adults. A child's exposure may differ from an adult's exposure in many ways. Children drink more fluids, eat more food, and breathe more air per kilogram of body weight, and have a larger skin surface in proportion to their body volume. A child's diet often differs from that of adults. The developing human's source of nutrition changes with age: from placental nourishment to breast milk or formula to the diet of older children who eat more of certain types of foods than adults. A child's behavior and lifestyle also influence exposure. Children crawl on the floor; they put things in their mouths; they may ingest inappropriate things such as dirt or paint chips; they spend more time outdoors. Children also are closer to the ground, and they do not have the judgement of adults in avoiding hazards (NRC 1993).

Children, like adults, are subject to low level *n*-hexane background exposures associated with emissions from the combustion of motor fuels or heating oil or other uses of petroleum products. Some products used in the home, such as rubber cement, contain *n*-hexane and could pose exposure risks to children from inhalation. In addition to inhalation exposures through the normal use of such products in poorly ventilated interior areas, children may engage in "glue sniffing" substance-abuse behaviors that could pose serious

5. POTENTIAL FOR HUMAN EXPOSURE

inhalation exposure risks. Dermal exposures are also possible from hexane-containing household products. For very small children, accidental ingestion of hexane-containing materials is also a potential exposure risk. Other potential exposures are possible from hazardous waste sites. There have been no documented secondary or take-home exposures for children from materials transferred from the parents' workplace on clothes, skin, hair, tools, or other objects (NIOSH 1995). Such exposure risks are not expected to be a concern with *n*-hexane because it is highly volatile.

Although concentration levels were not reported, studies have shown detections of *n*-hexane in human breast milk (Pellizzari et al.1982). In chapter 2, the discussion of PBPK modeling suggests the likelihood for breast milk transfers to nursing infants. No studies were identified dealing with levels of *n*-hexane in amniotic fluid, meconium, cord blood, or neonatal blood that would document prenatal exposures. There are no studies dealing with exposure or body burden measurements on children. Given the absence of such studies targeted at children, it is unknown whether children are different in their weight-adjusted intake responses to *n*-hexane.

5.7 POPULATIONS WITH POTENTIALLY HIGH EXPOSURES

In addition to individuals who are occupationally exposed to *n*-hexane (see Section 5.5), there are several groups within the general population that have potentially high exposures (higher than background levels) to *n*-hexane. These populations include individuals living in proximity to sites where *n*-hexane is produced or sites where *n*-hexane is disposed, and individuals living near the 60 NPL hazardous waste sites where *n*-hexane has been detected in some environmental media (HazDat 1998). Work situations where *n*-hexane is used as a solvent or in adhesives and where there are very poor ventilation conditions could also involve elevated exposure risks. Workers in poorly ventilated confined areas (e.g., warehouses, garages, tunnels) or trenches where *n*-hexane levels could build up from engine exhaust or from off-gassing, as in some landfill sites, might also experience higher exposures.

Workers in tire-manufacturing facilities may have a heightened potential for health hazards since the rubber vulcanization process can involve exposures to *n*-hexane (Graham et al.1995).

Individuals who subject themselves to substance abuse by inhaling *n*-hexane or vapors from products containing significant levels of *n*-hexane would also experience potentially high exposure levels (Altenkirch et al.1982; Graham et al.1995).

5. POTENTIAL FOR HUMAN EXPOSURE

5.8 ADEQUACY OF THE DATABASE

Section 104(i)(5) of CERCLA, as amended, directs the Administrator of ATSDR (in consultation with the Administrator of EPA and agencies and programs of the Public Health Service) to assess whether adequate information on the health effects of *n*-hexane is available. Where adequate information is not available, ATSDR, in conjunction with the NTP, is required to assure the initiation of a program of research designed to determine the health effects (and techniques for developing methods to determine such health effects) of *n*-hexane.

The following categories of possible data needs have been identified by a joint team of scientists from ATSDR, NTP, and EPA. They are defined as substance-specific informational needs that if met would reduce the uncertainties of human health assessment. This definition should not be interpreted to mean that all data needs discussed in this section must be filled. In the future, the identified data needs will be evaluated and prioritized, and a substance-specific research agenda will be proposed.

5.8.1 Identification of Data Needs

Physical and Chemical Properties. Data on physical and chemical properties are essential for estimating the partitioning of a chemical in the environment. The data on known physical and chemical properties form the basis of many of the input requirements for environmental models that predict the behavior of a chemical under specific conditions including those in hazardous waste landfills. Most of the necessary data on physical and chemical properties are available for *n*-hexane.

Production, Import/Export, Use, Release, and Disposal. Production methods for *n*-hexane are described in the literature, and there does not appear to be a need for further information. Uses of *n*-hexane are documented, although a detailed description of all uses is not available. Quantitative estimates of production levels for the more highly purified forms of *n*-hexane are available. The amounts of *n*-hexane associated with many types of motor and heating fuels can only be roughly estimated. Information on import and export levels is lacking. This information would be useful for estimating the potential for environmental releases from manufacturing and use industries as well as the potential environmental burden. However, it is difficult to obtain this information in the detail desired since it is generally considered to be confidential business information for those industries that manufacture *n*-hexane. Information on disposal practices is limited.

5. POTENTIAL FOR HUMAN EXPOSURE

According to the Emergency Planning and Community Right-to-Know Act of 1986, 42 U.S.C. Section 11023, industries are required to submit chemical release and off-site transfer information to the EPA. The Toxics Release Inventory (TRI) contains this information. This database will be updated yearly and provides a list of industrial production facilities and emissions. *n*-Hexane was added to the TRI process, with data available for an inventory baseline of 1996 (TRI96 1998).

Environmental Fate. *n*-Hexane is a highly volatile hydrocarbon and will partition to the atmosphere if released into surface waters or onto land surfaces. The fate of *n*-hexane in air is reasonably well described, with free radical degradation from hydroxyl radicals being of major importance. In water, biodegradation studies in surface water and groundwater are very limited, with most studies involving various petroleum fractions. Few studies were identified dealing explicitly with the fate of *n*-hexane in soils. Available studies (Heringa et al. 1961, Leahy and Colwell 1990, Rosenberg et al. 1992) indicate that *n*-hexane, along with other linear alkanes, is readily biodegraded under aerobic conditions. In soils near the surface, *n*-hexane's high volatility will usually result in its rapid transfer to the atmosphere. Given the volatility of *n*-hexane and its ready biodegradation under aerobic conditions, the most important data needed would involve degradation processes in groundwater, especially under anoxic conditions. Further research is needed to identify the rates of any relevant abiotic decay and transformation mechanisms (e.g., hydrolysis). These kinds of studies are important because they provide information about the movement or fundamental mechanisms of destruction of *n*-hexane in the environment and aid in understanding the behavior of *n*-hexane at hazardous waste sites.

Bioavailability from Environmental Media. Inhalation studies of humans indicate that *n*-hexane is bioavailable from the atmosphere. Although *n*-hexane in water or soil is likely to undergo transport to the air because of its volatility (although this would not necessarily be the case with *n*-hexane in groundwater), pharmacokinetic absorption studies using the oral and dermal routes of exposure would help clarify the bioavailability of *n*-hexane from water, soil, plant material, and other environmental media.

Food Chain Bioaccumulation. The physical constants for *n*-hexane (high volatility) and a low estimated BCF value for a typical fathead minnow forage fish (ASTER 1995) suggest that *n*-hexane will not concentrate significantly in aquatic organisms. No empirical information is available concerning BCFs for particular species or concerning the bioaccumulation or biomagnification of *n*-hexane in environmental media other than water. Information concerning the accumulation of *n*-hexane in several trophic levels would be useful in estimating human dietary intake; however, little intake is expected.

5. POTENTIAL FOR HUMAN EXPOSURE

Exposure Levels in Environmental Media. Some environmental monitoring data are available for *n*-hexane in air, while very limited data are available for drinking water, surface water, groundwater, and foodstuffs. Available data for air provide a very uneven coverage for background ambient settings, and recent investigations for contexts associated with commuter traffic or workplace settings are very sparse. The data for water are not sufficient to accurately characterize the concentrations present in drinking water, surface water, and groundwater. Virtually no data are available for soils. These data would be helpful in determining the environmental concentrations of *n*-hexane so that exposure of the general population as well as of terrestrial and aquatic organisms could be estimated.

Reliable monitoring data for the levels of *n*-hexane in contaminated media at hazardous waste sites are needed so that the information obtained on levels of *n*-hexane in the environment can be used in combination with the known body burdens of *n*-hexane to assess the potential risk of adverse health effects in populations living in the vicinity of hazardous waste sites.

Exposure Levels in Humans. The database for *n*-hexane exposure levels in humans is limited to a few older detections of *n*-hexane in breast milk and determinations of levels in body fluids and alveolar air collected in foreign countries. A more current and complete database would be helpful in determining the current exposure levels, thereby permitting the estimation of the average daily dose associated with various scenarios (e.g., living near a hazardous waste site). Since *n*-hexane is rapidly metabolized within the human body, further studies correlating levels in the environment with the levels of metabolites and biomarkers in humans would be helpful. This information is necessary for assessing the need to conduct health studies on these populations.

Exposures of Children. Better documentation of the types of household products that still contain *n*-hexane would be extremely valuable since inhalation of vapors from such products in poorly ventilated interior rooms could pose exposure risks to children. Additional studies on *n*-hexane concentrations in breast milk are important to validate the findings from PBPK modeling discussed in Chapter 2.

Exposure Registries. *n*-Hexane is not currently one of the compounds for which a subregistry has been established in the National Exposure Registry. *n*-Hexane will be considered in the future when chemical selections are made for subregistries to be established. The information that is amassed in the National Exposure Registry facilitates the epidemiological research needed to assess adverse health outcomes related to exposures.

5. POTENTIAL FOR HUMAN EXPOSURE

5.8.2 Ongoing Studies

Few studies dealing with opportunities for human exposure related to *n*-hexane were located in the literature. One set of ongoing studies under Dr. Charlene Bayer at the Georgia Institute of Technology (Bayer 1995) is examining metabolic gases from certain common fungi found in ductwork, crawl spaces, or the interiors of houses and office buildings. These metabolic gases can contain a variety of VOCs, including *n*-hexane. Exposure to these VOCs may play a role in the commonly designated "sick building syndrome."

As part of the Third National Health and Nutrition Evaluation Survey (NHANES III), the Environmental Health Laboratory Sciences Division of the National Center for Environmental Health, Centers for Disease Control and Prevention, will be analyzing human blood samples for *n*-hexane and other volatile organic compounds. These data will give an indication of the frequency of occurrence and background levels of these compounds in the general population.

6. ANALYTICAL METHODS

The purpose of this chapter is to describe the analytical methods that are available for detecting, and/or measuring, and/or monitoring hexane, its metabolites, and other biomarkers of exposure and effect to hexane. The intent is not to provide an exhaustive list of analytical methods. Rather, the intention is to identify well-established methods that are used as the standard methods of analysis. Many of the analytical methods used for environmental samples are the methods approved by federal agencies and organizations such as EPA and the National Institute for Occupational Safety and Health (NIOSH). Other methods presented in this chapter are those that are approved by groups such as the Association of Official Analytical Chemists (AOAC) and the American Public Health Association (APHA). Additionally, analytical methods are included that modify previously used methods to obtain lower detection limits, and/or to improve accuracy and precision.

6.1 BIOLOGICAL SAMPLES

n-Hexane can be determined in biological fluids and tissues and breath using a variety of analytical methods. Representative methods are summarized in Table 6-1. Most methods utilize gas chromatographic (GC) techniques for determination of *n*-hexane. The three methods used for preparation of biological fluids and tissues for analysis are solvent extraction, direct aqueous injection, and headspace extraction. Breath samples are usually collected on adsorbent traps or in sampling bags or canisters prior to analysis by GC.

Solvent extraction permits concentration of analytes, thereby increasing sensitivity, but the extraction solvent can interfere with analysis, and evaporative losses make quantitation difficult. Direct aqueous injection is a very rapid method, but sensitivity is low and matrix effects can be a serious problem. The headspace extraction method involves equilibrium of volatile analytes between the liquid or solid-sample phase and the gaseous phase. The gaseous phase is then analyzed by GC. There are two main types of headspace extraction methodology: static (equilibrium) headspace extraction and dynamic headspace extraction, which is usually called the purge-and-trap method (Seto, 1994). The static headspace extraction technique is relatively simple but may be less sensitive than the purge-and-trap method. The purge-and-trap method, while providing increased sensitivity, requires more complex instrumentation and may result

Table 6-1. Analytical Methods for Determining n-Hexane in Biological Samples

Sample matrix	Preparation method	Analytical method	Sample detection limit	Percent recovery	Reference
Blood	Isotope dilution; homogenization; solvent extraction; centrifugation	GC/MS-SIM	≈100 ng/mL or ng/g	102	White et al. 1979
Blood	Headspace extraction	cap. GC/ITD	9.5 ng/L	Not reported	Schuberth 1994
Blood	Headspace; cryogenic trapping; thermal desorption	cap. GC/MSD	15 ng/L	Not reported	Brugnone et al. 1991
Urine	Headspace	cap. GC/MSD-SIM	0.5 µg/L (calculated)	98–101	Imbriani et al. 1984
Blood, urine, adipose tissue	Dynamic headspace purge	cap. GC/FID	Not reported	86–120 (blood); 48–110 (urine); 13–80 (adipose) for model compounds	Michael et al. 1980
Tissues	Isotope dilution; homogenization; solvent extraction; centrifugation	GC/MS-SIM	≈100 µg/L	104	White et al. 1979
Breath (alveolar air)	Collection in glass tube	cap. GC/MSD	Not reported	Not reported	Brugnone et al. 1991
Breath (exhaled air)	Collection using modified Haldan-Priestly tube sampler; collection on adsorbent traps; CS ₂ desorption	GC	0.015 mg/m ³ (1 L sample)	94.6–99.4	Periago et al. 1991
Exhaled air	Collection in aluminum tube; adsorption on charcoal; CS ₂ desorption	GC/FID	Not reported	Not reported	Cardona et al. 1996

cap. = capillary; CS₂ = carbon disulfide; FID = flame ionization detector; GC = gas chromatography; ITD = ion trap detector; MS = mass spectrometry; MSD = mass selective detector; SIM = selected ion monitoring

6 ANALYTICAL METHODS

in artifact formation (Seto 1994). Packed and capillary columns are used for chromatographic separation, followed by flame ionization detection (FID) or mass spectrometry (MS) techniques.

Measurement of *n*-hexane in breath has been rather widely used to evaluate environmental and occupational exposures. A variety of methods are available for monitoring *n*-hexane in breath, but most have not been tested rigorously for reliability. Breath samples may be collected in glass tubes (alveolar air) and analyzed by GC/MS (Brugnone et al.1991). No performance data or detection limits are available for this method. Exhaled air samples may be collected using modified glass tube samplers onto an adsorbent followed by solvent desorption and analysis by GC (Periago et al.1991). Good recovery (>94%) and precision (<12% relative standard deviation [RSD]) were reported; the detection limit was 0.015 mg/m³ (4 ppb) for a 1 L sample (Periago et al.1991). Spirometers are used to collect volatile organic compounds in breath since they provide clean air for inhalation and thus prevent contamination by the environmental air. Although these systems are used extensively for monitoring environmental exposure, very little information for *n*-hexane is available. Current systems are compact and include collection of breath into chemically inert passivated canisters (Raymer et al.1994; Thomas et al.1991) and Tedlar bags.

Few well characterized, validated methods are available for the determination of *n*-hexane in blood. A purge-and-trap method for volatiles has been developed and validated by researchers at the Centers for Disease Control and Prevention (CDC) (Ashley et al.1992, 1994). Extension of the method to include *n*-hexane should be possible. Current analytical methods utilize capillary GC columns and MS detection to provide the sensitivity and selectivity required for the analysis. Detection limits are in the low ppb range (Brugnone et al.1991; Schuberth 1994). Headspace extraction followed by GC analysis has also been utilized for the determination of *n*-hexane in blood (Brugnone et al.1991; Michael et al.1980; Schuberth 1994); however, very little performance data are available.

Some methods are available for determining *n*-hexane in urine and tissues. A modified dynamic headspace extraction method for urine, mother's milk, and adipose tissue has been reported (Michael et al.1980). Volatiles swept from the sample are analyzed by capillary GC/FID. Acceptable recovery was reported for model compounds; detection limits were not reported (Michael et al.1980). A solvent extraction procedure utilizing isotope dilution followed by GUMS analysis has been reported for tissues (White et al.1979). Recovery was good (104%) and detection limits are approximately 100 ng/mL (White et al.1979).

6. ANALYTICAL METHODS

Exposure to *n*-hexane is evaluated by measuring the levels of this compound in blood, urine, and exhaled breath and by measuring the levels of 2,5-hexanedione, a neurotoxic metabolite of *n*-hexane, in urine. A summary of the methods used for determining biomarkers for *n*-hexane is presented in Table 6-2.

Urine is often analyzed for the neurotoxic metabolite 2,5-hexanedione to evaluate *n*-hexane exposure. The major metabolites of *n*-hexane present in urine are 2,5-hexanedione and 4,5-dihydroxy-2-hexanone. Acid treatment (a routine step in chemical analysis of urine) converts 4,5-dihydroxy-2-hexanone to 2,5-hexanedione (Fedtke and Bolt 1986a, 1986b). Thus, 2,5-hexanedione may be expressed as “free” compound (without acid treatment) or “total” compound (with acid treatment) (Cardona et al.1996). No reports were located describing conjugated metabolites of *n*-hexane in urine (e.g. glucuronides, sulfates). Urinalysis for metabolites provides adequate sensitivity when exposure is relatively high but may not provide adequate sensitivity for evaluating low exposures (Kawai et al.1992). As analytical methods have improved it has become clear that 2,5-hexanedione can also be detected in the acid-treated urine of individuals without specific exposure to *n*-hexane (Fedtke and Bolt 1986a; Perbellini et al.1993). It is possible that small amounts of *n*-hexane are produced normally in the body as the result of fatty acid metabolism. A reference value for an Italian population is available (Bavazzano et al.1998). Specific methods also exist for measuring another *n*-hexane metabolite in urine, 2-hexanone (Table 6-2).

6.2 ENVIRONMENTAL SAMPLES

Methods are available for determining *n*-hexane in a variety of environmental matrices. A summary of representative methods is shown in Table 6-3. Validated methods, approved by agencies and organizations such as EPA, the American Society for Testing and Materials (ASTM), APHA, and NIOSH, are available for air matrices. GC/FID and GC/MS are the most widely used analytical techniques for quantitating concentrations of *n*-hexane in environmental matrices. Because of the complexity of the sample matrix and the usually low concentrations of volatile organic compounds in environmental media, sample preconcentration is generally required prior to GC analysis. Air samples may be collected and concentrated on adsorbent prior to analysis. Methods suitable for determining trace amounts of *n*-hexane in aqueous and other environmental media include three basic approaches to the pretreatment of the sample: gas purge-andtrap, headspace extraction gas analysis, and extraction with organic solvents.

n-Hexane may be determined in occupational air using collection on a charcoal adsorbent, followed by solvent desorption (Hakkola and Saarinen 1996; Rosenberg et al.1992), or thermal desorption (Tang et al.

Table 6-2. Analytical Methods for Determining Biomarkers of *n*-Hexane in Biological Samples

Sample matrix	Preparation method	Analytical method	Sample detection limit	Percent recovery	Reference
Tissues and blood (2-hexanone)	Isotope dilution; homogenization; solvent extraction; centrifugation	GC/MS-SIM	≈0.05 µg/g	105 (tissues), 98 (blood)	White et al. 1979
Tissues and blood (2,5-HD)	Isotope dilution; homogenization; solvent extraction; centrifugation	GC/MS-SIM	≈0.08 µg/g	104 (tissues), 108 (blood)	White et al. 1979
Urine (2,5-HD)	Acid hydrolysis; derivatization	HPLC/UV	30 ng/L (calculated)	≈94	Gori et al. 1995
Urine (2,5-HD)	Acid hydrolysis; SPE extraction; cleanup by SPE	HPLC/UV; confirmation by cap. GC/FTIR	0.05 mg/L	85	Columbini et al. 1992
Urine (2,5-HD)	Derivatization; SPE extraction	cap. GC/ECD	4.7 ng/mL (calculated)	Not reported	van Engelen et al. 1995
Urine (2,5-HD)	Derivatization; solvent extraction	cap. GC/ECD	2.8 ng/mL (calculated)	Not reported	van Engelen et al. 1995
Urine (2,5-HD)	Solvent extraction	cap. GC/FID	10 ng/mL (calculated)	98.6–106	van Engelen et al. 1995
Urine (total and free 2,5-HD)	Acid hydrolysis (total 2,5-HD); fractionation on sorbent minicolumns; solvent extraction	cap. GC/FID	Not reported	Not reported	Cardona et al. 1996

cap. = capillary; GC = gas chromatography; ECD = electron capture detector; FID = flame ionization detection; FTIR = Fourier transform infrared spectrometry; 2,5-HD = 2,5-hexanedione; HPLC = high performance liquid chromatography; MS = mass spectrometry; SIM = selected ion monitoring; SPE = solid-phase extraction; UV = ultraviolet (detection)

Table 6-3. Analytical Methods for Determining n-Hexane in Environmental Samples

Sample matrix	Preparation method	Analytical method	Sample detection limit	Percent recovery	Reference
Occupational air (breathing zone)	Collection on charcoal adsorbent; CS ₂ desorption	GC/FID	0.006–1.1 ppb (50 L sample)	Not reported	Rosenberg et al. 1991
Occupational air (breathing zone)	Collection on charcoal tubes; DMF desorption	dual column cap. GC/FID	≈0.5 µg/sample (for 1–4 L sample)	Not reported	Hakkola and Saarinen 1996
Occupational air	Collection in canisters	cap. GC/FID	Not reported	87.8 (collection efficiency)	Tang et al. 1996
Occupational air	Collection on charcoal adsorbent; thermal desorption	cap. GC/FID	≈0.6 ppb (0.5 L sample)	86.4 (collection efficiency)	Tang et al. 1996
Ambient air	Collection on Tenax adsorbent; thermal desorption and cryofocussing	cap. GC/MS	Not reported	75–98 (all target compounds)	Krost et al. 1982
Ambient air	Collection in canisters; cryofocus	cap. GC/FID or GC/MS	Not reported	Not reported	EPA 1988 (Method TO-14)
Ambient air	Collection on dual multisorbent traps; thermal desorption	cap. GC/FID	0.14 ppb	Not reported	Oliver et al. 1996
Ambient air	Collection in canisters	cap. GC/FID	low-ppt range	Not reported	McLaren et al. 1996; Lai et al. 1993
Indoor air	Collection on Tenax adsorbent; thermal desorption	cap. GC/MS	0.014–0.06 ppb	Not reported	Kostianen 1995
Emissions from vegetation	Collection in canisters; cryogenic concentration	cap. GC/FID	0.1–0.02 µg/m ² /h	Not reported	Fukui and Doskey 1996
Vehicle emissions	Collection in foil bags	GC	≈30 µg/m ³	Not reported	Cooper et al. 1996

Table 6-3. Analytical Methods for Determining n-Hexane in Environmental Samples (continued)

Sample matrix	Preparation method	Analytical method	Sample detection limit	Percent recovery	Reference
Emissions from consumer products	Collection on charcoal adsorbent; CS ₂ desorption	cap. GC/FID	Not reported	Not reported	Wadden et al. 1995
Stack gas effluents	Collection on volatile organic sampling train (VOST)	GC/MS	Not reported	Not reported	EPA 1994i (Method 0030 - collection); EPA 1994k (Method 5041 - analysis)
Water	Purge and trap	GC/FID	≈0.05 µg/L	Not reported	Biziuk et al. 1996
Water	Purge and trap	cap. GC/MS	low- to sub-ppb levels (µg/L)	90–120	Michael et al. 1988
Water	Purge and trap	cap. GC/FID	35–1,760 µg/L (gasoline)	77	Belkin and Hable 1988
Water	Distillation; purge and trap	GC/FID	Not reported	83–87	Kozloski 1985
Water, soil	Headspace extraction	GC/MSD	0.5 µg/L	Not reported	Roberts and Burton 1994
Soil	Supercritical fluid extraction	cap. GC/FID	Not reported	86–90 (trapping efficiency)	Yang et al. 1995
Sediment	Elevated temperature dynamic headspace extraction	cap. GC/FID, GC/ITD	20 ng/kg	Not reported (bias 2–16%)	Bianchi et al. 1991

cap. = capillary; CS₂ = carbon disulfide; DMF = dimethylformamide; FID = flame ionization detector; GC = gas chromatography; ITD = ion trap detector; MS = mass spectrometry; MSD = mass selective detector

6. ANALYTICAL METHODS

1996), then capillary GC/FID analysis (Hakkola and Saarinen 1996; Tang et al.1996). Samples may also be collected in canisters with subsequent capillary GC/FID analysis (Tang et al.1996). Detection limits are in the low ppb ($\mu\text{g}/\text{m}^3$) range (Hakkola and Saarinen 1996; Rosenberg et al.1992; Tang et al.1996). Collection efficiencies of 87.8% (8.6% RSD) for canisters and 86.4% (9.4% RSD) for carbon adsorbent have been reported (Tang et al.1996). Both methods showed a loss of 10% or less after storage for 14 days (Tang et al.1996). Passive samplers are finding increased use, due in part to their small size and ease of use. The compounds on the adsorbent in the sampler is desorbed by solvent and the extract analyzed by GC techniques. Detection limits are reported to be in the low ppb range (Otson et al.1994) and appear to be comparable to other monitoring methods (Bartolucci et al.1986; Gentry and Walsh 1987). All these methods provide detection well below the Minimal Risk Level (MRL) of 0.6 ppm for the health effects in humans for chronic-duration inhalation exposure to *n*-hexane (Appendix A).

Gas purge-and-trap is the most widely used method for the isolation and concentration of volatile organic compounds in environmental samples (Lesage 1993). The purge-and-trap technique offers advantages over other techniques because it allows isolation and concentration of target compounds, thereby improving overall limits of detection (LODs) and recovery. A potential problem of this technique is interference by impurities in the stripping gas. Detection limits of less than 1 μg of *n*-hexane per liter of sample (1 ppb) have been achieved (Michael et al.1988).

Ambient air may also be collected on adsorbent traps (Krost et al.1982; Oliver et al.1996) or in stainless steel canisters (Anlauf et al.1985; EPA 1988; McLaren et al.1996). Detection limits, where reported, are in the low ppb to low parts per trillion (ppt) range (Anlauf et al.1985; McLaren et al.1996; Oliver et al. 1996). Recovery of 75-98% (for all compounds tested) has been reported for collection on Tenax adsorbent (Krost et al.1982). Passive monitors are utilized for ambient air and indoor air (Cao and Hewitt 1993; Fellin and Otson 1994; Otson et al.1994). Detection limits in the low ppb range have been reported (Otson et al.1994).

Dynamic headspace-extraction stripping and purge-and-trap methodology are used most often for determination of *n*-hexane in water and hazardous wastes. Dynamic headspace extraction techniques have been applied to water samples (Roberts and Burton 1994) and sediment (Bianchi et al.1991). Detection limits of 0.5 $\mu\text{g}/\text{L}$ were reported for lake water (Roberts and Burton 1994) and 20 ng/kg (ppt) for sediment (Bianchi et al.1991). Supercritical fluid extraction (SFE) is a relatively new technique that has been applied to *n*-hexane in soil (Yang et al.1995). Membrane extraction of *n*-hexane from water samples has

6. ANALYTICAL METHODS

been developed to provide online, continuous monitoring (Wong et al.1995; Xu and Mitra 1994). The extract is analyzed directly by MS (Wong et al.1995) or subjected to conventional capillary GC/FID analysis (Xu and Mitra 1994). Detection limits are in the low ppb range (Wong et al.1995; Xu and Mitra 1994).

No methods were located for determination of *n*-hexane in biota or foods.

6.3 ADEQUACY OF THE DATABASE

Section 104(i)(5) of CERCLA, as amended, directs the Administrator of ATSDR (in consultation with the Administrator of EPA and agencies and programs of the Public Health Service) to assess whether adequate information on the health effects of hexane is available. Where adequate information is not available, ATSDR, in conjunction with the NTP, is required to assure the initiation of a program of research designed to determine the health effects (and techniques for developing methods to determine such health effects) of hexane.

The following categories of possible data needs have been identified by a joint team of scientists from ATSDR, NTP, and EPA. They are defined as substance-specific informational needs that if met would reduce the uncertainties of human health assessment. This definition should not be interpreted to mean that all data needs discussed in this section must be filled. In the future, the identified data needs will be evaluated and prioritized, and a substance-specific research agenda will be proposed.

6.3.1 Identification of Data Needs

Methods for Determining Biomarkers of Exposure and Effect. Exposure to *n*-hexane is evaluated by measuring the levels of this compound in blood, urine, and exhaled breath and by measuring the levels of 2,5-hexanedione, a neurotoxic metabolite of *n*-hexane, in urine. The available methods are sufficiently sensitive and reliable for monitoring occupational exposures to *n*-hexane. They may not be sensitive enough to monitor levels at which biological effects occur. Few methods are available for measuring *n*-hexane in blood (Brugnone et al.1991; Schuberth 1994). Development of these methods or other established methods for the determination of volatile organic compounds in blood (Ashley et al.1992, 1994) with improved specificity and sensitivity would be valuable in measuring low-level exposures to *n*-hexane and background exposures in the general population. Measurement of *n*-hexane levels in urine

6. ANALYTICAL METHODS

has been used as a noninvasive method for evaluating exposure to the compound. Available methods are reliable (Imbriani et al.1984; Kawai et al.1993); however, this measurement is not as sensitive as measuring *n*-hexane in blood for evaluating low-level exposures to *n*-hexane (Kawai et al.1993). Measurement of *n*-hexane in breath is another noninvasive method for evaluating exposure to *n*-hexane, particularly occupational exposures (Brugnone et al.1991; Periago et al.1991). Development of simple, reliable field methods and standardization of the sampling methodology would be helpful for exposure monitoring. Methods for determining *n*-hexane in tissues are generally lacking. Development of a method for monitoring this compound in other biological matrices, particularly mother's milk, would be useful.

Urine may be analyzed for the neurotoxic metabolite, 2,5-hexanedione, to evaluate *n*-hexane exposure; however, results for various preparation methods are not comparable. Urinalysis for metabolites provides adequate sensitivity when exposure is relatively high but may not provide adequate sensitivity for evaluating low exposures (Kawai et al.1992). Standardization of urinalysis methods and development of methods with greater sensitivity are needed.

The neurotoxic effects of *n*-hexane have been associated with the pyrrolidation of protein (Graham et al. 1995) by 2,5-hexanedione. Therefore, the development of analytical methods to determine this potential biomarker of effect of *n*-hexane in hair and the subsequent crosslinking of the blood proteins, spectrin and hemoglobin, would be useful.

Methods for Determining Parent Compounds and Degradation Products in Environmental

Media. Air is the medium of most concern for human exposure to *n*-hexane. Exposure from drinking water may also be of concern in some areas, such as near hazardous waste sites. Existing methods are sufficiently sensitive and reliable to monitor environmental air (Hakkola and Saarinen 1996; Rosenberg et al.1992; Tang et al.1996). Methods for measuring ambient air provide the sensitivity required for monitoring *n*-hexane at low levels at which biological effects are expected to occur and at low and background levels. Additional performance data would be helpful. Available methods for determination of *n*-hexane in water provide adequate sensitivity for measurement of sub-ppb levels of *n*-hexane (Biziuk et al. 1996; Michael et al.1988). Additional performance data would allow better comparability of results.

6. ANALYTICAL METHODS

6.3.2 Ongoing Studies

The Environmental Health Laboratory Sciences Division of the National Center for Environmental Health, Centers for Disease Control and Prevention, is developing methods for the analysis of *n*-hexane and other volatile organic compounds in blood. These methods use purge-and-trap methodology, high resolution gas chromatography, and magnetic sector MS which gives detection limits in the low ppt range.

7. REGULATIONS AND ADVISORIES

The international, national, and state regulations and guidelines pertaining to *n*-hexane in air, water, and other media are summarized in Table 7-1.

A chronic-duration inhalation MRL of 0.6 ppm has been derived by ATSDR, based on a LOAEL of 58 ppm for reduced motor nerve conduction velocity in occupationally exposed workers (Sanagi et al. 1980).

The Environmental Protection Agency (EPA) inhalation reference concentration (RfC) for *n*-hexane is 0.2 mg/m³ (0.06 ppm by volume). No reference dose (RfD) has been derived for this compound (IRIS 1998).

The EPA has determined that *n*-hexane is not classifiable as to its human carcinogenicity (Group D) (EPA 1996f). The International Agency for Research on Cancer (IARC) and the World Health Organization (WHO) have not classified *n*-hexane for carcinogenicity (IARC 1987). Although the American Conference of Governmental Industrial Hygienists (ACGIH) has not classified *n*-hexane for carcinogenicity, it has assigned a biological exposure index (BEI) of 5 mg/g creatinine for the neurotoxic metabolite of *n*-hexane, 2,5-hexanedione in urine (ACGIH 1996). The BEI is a reference value intended as a guideline for the evaluation of potential health hazards in the workplace (ACGIH 1996).

OSHA requires employers of workers who are occupationally exposed to *n*-hexane to institute engineering controls and work practices to reduce and maintain employee exposure at or below permissible exposure limits (PELs). The employer must use controls and practices, if feasible, to reduce exposure to or below an 8-hour time-weighted average (TWA) of 500 ppm (1,800 mg/m³) (OSHA 1974). The PEL for *n*-hexane was to have been lowered to 50 ppm in 1989; however, a U.S. Court of Appeals decision overturned a number of PELs promulgated in 1989, including that for *n*-hexane. The PEL in force prior to this decision (500 ppm) is currently in effect.

According to the Emergency Planning and Community Right-to-Know Act (EPCRA) of 1986, 42 U.S.C. Section 11023, industries are required to submit chemical release and off-site transfer information to the EPA. Section 313 of Title III of EPCRA requires owners and operators of certain facilities that manufacture, import, process, or otherwise use the chemicals on this list to report annually their release of

7. REGULATIONS AND ADVISORIES

those chemicals to any environmental media (U.S. Congress 1986). The Toxics Release Inventory (TRI) contains this information. This database will be updated yearly and provides a list of industrial production facilities and emissions. On January 22, 1994, the EPA proposed that *n*-hexane be added to the list of chemicals subject to the requirements of EPCRA (EPA 1994a). The proposed rule was adopted on November 22, 1994 (EPA 1994e). *n*-Hexane was added to the TRI process, with data available for an inventory baseline of 1996 (TRI96 1998).

The EPA regulates *n*-hexane under the Clean Air Act (CAA) and has designated *n*-hexane as a hazardous air pollutant (HAP) (U.S. Congress 1990; EPA 1994b, 1994c). *n*-Hexane is included on the list of organic HAPS from the synthetic organic chemicals manufacturing industry (SOCMI) (EPA 1994b). The major SOCMI source categories for which EPA has established national emission standards are process vents, storage vessels, transfer operations, wastewaters (EPA 1994d), polymers and resins (EPA 1996a), petroleum refineries (EPA 1995a), offsite waste and recovery operations (EPA 1996b), and wood-furniture manufacturing operations (EPA 1995b). The SOCMI new stationary sources for which EPA has promulgated performance standards for *n*-hexane are distillation operations (EPA 1990) and reactor processes (EPA 1993b). In September 1996, the EPA promulgated national emission standards for hazardous air pollutants (NESHAP) from existing and new plant sites that emit organic HAPS during the manufacture of one or more elastomers (EPA 1996f). *n*-Hexane and several other HAPS (e.g., styrene, acrylonitrile, toluene, and 1,3-butadiene) identified as being emitted by these Group I polymer and resins sources can cause reversible and irreversible toxic effects following exposure. Emissions data evaluated in conjunction with the development of the elastomer standards showed that implementing the NESHAP could potentially reduce emissions of these HAPS (EPA 1996f). The EPA estimates that implementing the final rule would reduce organic HAP emissions from existing affected sources by more than 6,300 megagrams (6.3×10^6 kg) per year (Mg/yr). Since the majority of organic HAPS to be regulated by the standard are volatile organic compounds (VOCs), implementing the standard would also reduce VOC emissions (EPA 1996f).

n-Hexane is regulated by the Clean Water Effluent Guidelines in Subchapter N of Title 40 of the Code of Federal Regulations. The source category for which the discharge of *n*-hexane in process wastewaters is applicable is the organic chemicals, plastics, and synthetic fibers manufacturing industry (EPA 1987b). This industry includes manufacturers of cyclic crudes and intermediates, dyes, organic pigments, and certain industrial organic chemicals (EPA 1987b). On May 1, 1995, the EPA published a proposed rule to establish a pretreatment standards of 796 μ L (1-day maximum) and a new sources performance

7. REGULATIONS AND ADVISORIES

standards of 573 µg/L (1-day maximum) for the fermentation, extraction, chemical synthesis, and mixing compounding and formulating subcategories under the pharmaceutical manufacturing point source category (EPA 1995c). The proposed rule continues to be reviewed.

On March 1, 1994, the EPA proposed to regulate *n*-hexane under the Resource Conservation and Recovery Act (RCRA) by including *n*-hexane as part of the basis for listing K1.56 waste (i.e., organic waste from the production of carbamates and carbamoyl oximes) in 40 CFR 261, Appendix VII (EPA 1994f). The proposed rule would also add *n*-hexane to the list of hazardous constituents given in 40 CFR 261, Appendix VIII (EPA 1994f). Although the proposed rule was adopted on February 9, 1995, the EPA did not add *n*-hexane and several other chemicals to appendices VII or VIII (EPA 1995g). In addition to these chemicals no longer being significant to the carbamate industry, the results of the Agency's multi-pathway risk analysis showed that they did not present significant environmental or health-based risks (EPA 1995g).

7. REGULATIONS AND ADVISORIES

Table 7-1. Regulations and Guidelines Applicable to n-Hexane

Agency	Description	Information	References
INTERNATIONAL			
Guidelines:			
WHO	Drinking-water guideline values for health-related organics	None	WHO 1984
NATIONAL			
Regulations:			
a. Air:			
OSHA ^a	Air contaminants Permissible exposure limit (PEL): 8-hour time-weighted average (TWA)	500 ppm (1,800 mg/m ³)	29 CFR 1910.1000 OSHA 1974
EPA OAR	Hazardous Air Pollutants	Yes	Clean Air Act Amendment Title III, Section 112 (b) U.S. Congress 1990
	Standards of Performance for New Stationary Sources-		
	Subpart NNN: standards of performance for voc emissions from synthetic organic manufacturing industry (socmi) distillation operations--chemicals affected	Yes	40 CFR 60.667 EPA 1990
	Subpart RRR: standards of performance for voc emissions from synthetic organic manufacturing industry (socmi) reactor process-- chemicals affected	Yes	40 CFR 60.707 EPA 1993b
	National emission standards for hazardous air pollutants for source categories		
	Subpart F: national emission standards for organic hazardous air pollution from the socmi	Yes	40 CFR 63.100 EPA 1994b
	SOCMI chemicals	Yes	40 CFR 63.106 EPA 1994c
	Subpart G: national emission standards for organic hazardous air pollutants from the socmi for process vents, storage vessels, transfer operations, and wastewater	Yes	40 CFR 63, Appendix, Tables 8, 9 and 34 EPA 1994d
	Subpart U: national emission standards for HAP emissions: group I polymers and resins	Yes	40 CFR 63.506 EPA 1996a
	Subpart CC: national emission standards for HAPs from petroleum refineries	Yes	40 CFR 63., Appendix Tables 1, 5, and 7 EPA 1995a
	Subpart DD: national emission standards for HAPs from off-site waste and recovery operations	Yes	40 CFR 63.698 EPA 1996b

7. REGULATIONS AND ADVISORIES

Table 7-1. Regulations and Guidelines Applicable to n-Hexane (continued)

Agency	Description	Information		References
NATIONAL (cont.)				
	Subpart JJ: national emission standards for HAPs from wood furniture manufacturing operations-applicability	Yes		40 CFR 63.800 EPA 1995b
b. Water				
EPA OW				
	Organic Chemicals, Plastics, and Synthetic Fibers			
	Applicability; description of the bulk organic chemicals subcategory	Yes		40 CFR 414.70 EPA 1987b
	Effluent Guidelines and Standards: Pretreatment Standards and New Source Performance Standards: pharmaceutical manufacturing category (proposed rule)	1-day <u>maximum</u>	Monthly <u>Average</u> (µg/L)	60 FR 21592 EPA 1995c
	Fermentation subcategory			
	PSES: in-plant monitoring	796	268	
	PSNS: in-plant monitoring	573	212	
	Extraction subcategory			
	PSES: in-plant monitoring	796	268	
	PSNS: in-plant monitoring	573	212	
	Chemical synthesis subcategory			
	PSES: in-plant monitoring	796	268	
	PSNS: in-plant monitoring	573	212	
	Mixing Compounding and Formulating Subcategory			
	PSES: in-plant monitoring	796	268	
	PSNS: in-plant monitoring	573	212	
c. Other:				
DOT	Hazardous Materials Table	UN 1208		49 CFR 172.101 DOT 1990
EPA-OERR	List of Hazardous Substances and Reportable Quantities	1 pound (0.454 Kg) (CERCLA statutory)		40 CFR 302.4 EPA 1993a
		5000 pounds (2270 Kg) (final RQ)		
	Toxic Chemical Release Reporting: Community Right-to-know			
	Addition of certain chemicals; toxic chemical releases reporting; community right-to-know (proposed rule: 40 CFR 372)	Yes		59 FR 1788 EPA 1994a
	Addition of certain chemicals; toxic chemical releases reporting; community right-to-know (final rule: 40 CFR 372)	Yes		59 FR 61432 EPA 1994e

7. REGULATIONS AND ADVISORIES

Table 7-1. Regulations and Guidelines Applicable to n-Hexane (continued)

Agency	Description	Information	References
NATIONAL (cont.)			
EPA-OSW			
	Identification and Listing of Hazardous Wastes		
	Hazardous waste management system: carbamate production identification and listing of hazardous waste; and CERCLA hazardous substance designation and reportable quantities (proposed rule--40 CFR 261, Appendix VIII)	Proposed to include hexane as a hazardous constituent in K156 waste	59 FR 9808 EPA 1994f
	Hazardous waste management system: carbamate production identification and listing of hazardous waste; and CERCLA hazardous substance designation and reportable quantities (final rule)	Hexane removed from final list of chemicals to be added to Appendix VIII basis for listing for K156 waste	60 FR 7824 EPA 1995e
Guidelines:			
a. Air:			
ACGIH	Permissible Exposure Limit (PEL)-Time-weighted Average (TWA) Hexane	50 ppm (176 mg/m ³)	ACGIH 1996
	Other isomers:	500 ppm (1760 mg/m ³)	
	Short-term exposure limit (STEL) Ceiling		
	Other isomers	100 ppm (3500 mg/m ³)	
NIOSH	Recommended Exposure Limit (REL) for Occupational Exposure Hexane		NIOSH 1992
	TWA	50 ppm (180 mg/m ³)	
	Other isomers TWA	100 ppm (350 mg/m ³)	
	ceiling	510 ppm (1800 mg/m ³)	
b. Water:			
EPA ODW	1-day Health Advisory (child)-draft	10 mg/L	EPA 1996f
	10-day Health Advisory (Child)	4 mg/L	
	Lifetime Health Advisory (Adult)	0.75 mg/L	
	Long-term Health Advisory--up to approximately 7 years (10% of an Individual's Lifetime) of exposure	4 mg/L (child) 10 mg/L (adult)	

7. REGULATIONS AND ADVISORIES

Table 7-1. Regulations and Guidelines Applicable to *n*-Hexane (continued)

Agency	Description	Information	References
<u>NATIONAL</u> (cont.)			
d. Other:			
ACGIH	Biological Exposure Indices (BEI)	5 mg 2,5-hexanedione/ g creatinine	ACGIH 1996
EPA	Cancer Classification	D ^b	EPA 1996f
	Reference Concentration (RfC)	0.2 mg/m ³ (0.06 ppm)	IRIS 1998
<u>STATE</u>			
Regulations and Guidelines:			
a. Air:	Average Acceptable Ambient Air Concentrations (n-Hexane)		NATICH 1992
AZ	1 hour	5.30x10 ³ µg/m ³ (1.5 ppm)	
	24 hours	1.40x10 ³ µg/m ³ (0.397 ppm)	
CT	8 hours	3.60x10 ³ µg/m ³ (1.0 ppm)	
FL-Pinella	8 hours	1.8x10 ³ µg/m ³ (0.511 ppm)	
	24 hours	4.23x10 ² µg/m ³ (0.120 ppm)	
LA	8 hours	4.19x10 ⁺³ µg/m ³ (1.2 ppm)	
NC	24 hours	1.10 mg/m ³ (0.312 ppm)	NATICH 1992
	15 minutes	3.6x10 ² mg/m ³ (102.1 ppm)	
NC-Forsyth County	24 hours	1.0 mg/m ³ (0.284 ppm)	
ND	8 hour	1.76 mg/m ³ (0.499 ppm)	
NV	8 hours	4.29 mg/m ³ (1.2 ppm)	
OK	24 hours	1.76x10 ⁴ µg/m ³ (5.0 ppm)	
TX	30 minutes	1.76x10 ³ µg/m ³ (0.499 ppm)	
	Annual	1.76x10 ² µg/m ³ (0.050 ppm)	
VA	24 hours	2.90x10 ⁴ µg/m ³ (8.2 ppm)	
	24 hours	4.29x10 ³ µg/m ³ (1.2 ppm)	

7. REGULATIONS AND ADVISORIES

Table 7-1. Regulations and Guidelines Applicable to n-Hexane (continued)

Agency	Description	Information	References
<u>STATE</u> (cont.)			
WA-SWEST	24 hours	5.99x10 ² µg/m ³ (0.170 ppm)	
	Average Acceptable Ambient Air Concentrations (Other Isomers)		NATICH 1992
FL-Pinella	8 hours	3.60x10 ⁴ µg/m ³ (10.2 ppm)	
	24 hours	8.64x10 ³ µg/m ³ (2.5 ppm)	
NC-Forsyth County	15 minutes	3.60 mg/m ³ (1.0 ppm)	
ND	8 hours	1.76x10 ¹ mg/m ³ (5.0 ppm)	
	1 hour	3.5x10 ¹ mg/m ³ (9.9 ppm)	
WA-SWEST	24 hours	5.99x10 ³ µg/m ³ (1.7 ppm)	
b. Water			
<i>Water Quality Criteria: Human Health</i>			
AZ	Drinking water (guideline)	4.0x10 ³ µg/L	FSTRAC 1995
ME	Drinking water (guideline)	4.0x10 ³ µg/L	
MI	Drinking water (guideline)	2.9x10 ³ µg/L	Sittig 1994
MN	Drinking water (guideline)	4.0x10 ³ µg/L	FSTRAC 1995
NC	Drinking water (guideline)	14.3x10 ³ µg/L	
NJ	Drinking water (standard)	33 µg/L	
RI	Drinking water (guideline)	4.0x10 ³ µg/L	FSTRAC 1990
VT	Drinking water (standard)	4.0x10 ³ µg/L	

^a The PEL for n-hexane was to have been lowered to 50 ppm in 1989. However, a U.S. Court of Appeals rescinded the 1989 PELs promulgated by OSHA. Only PELs in place prior to the 1989 rule are currently allowed (58 FR 35338, June 30, 1993).

^b Cancer classification D indicates that the agent has not been classified for carcinogenicity. There is inadequate or no human and animal evidence of carcinogenicity.

ACGIH = American Conference of Governmental Industrial Hygienists; BEI = Biological Exposure Indices; CFR = Code of Federal Regulations; CWA = Clean Water Act; DOT = Department of transportation; EPA = Environmental Protection Agency; FSTRAC = Federal State Toxicology and Regulatory Alliance Committee; HAP = Hazardous Air Pollutants; IARC = International Agency for Research on Cancer; INCIN = Incineration; NATICH = National Air Toxics Information Clearinghouse; NIOSH = National Institute of Occupational Safety and Health; OAR = Office of Air and Radiation; ODW = Office of Drinking Water; OERR = Office of Emergency and Remedial Response; OSHA = Occupational Safety and Health Administration; OSW = Office of Solid Wastes; OW = Office of Water; PEL = Permissible Exposure Limit; PSES = Pretreatment Standards for Existing Sources; PSNS = Pretreatment Standards for New Sources; RQ = Reportable Quantities; SOCMI = Synthetic Organic Chemicals Manufacturing Industry; STEL = Short-term Exposure Limit; TWA = Time-weighted Average; VOC = Volatile Organic Compound; WHO = World Health Organization

8. REFERENCES

- *Abou-Donia MB, Hu ZH, Lapadula DM, et al.1991. Mechanisms of joint neurotoxicity of *n*-hexane, methyl isobutyl ketone and O-ethyl O-4-nitrophenyl phenylphosphonothioate in hens. *J pharmacol Exp Ther* 257(1):282-289.
- *Abou-Donia MB, Lapadula DM.1990. Mechanisms of organophosphorus ester-induced delayed neurotoxicity: Type I and type II. *Annu Rev Pharmacol Toxicol* 30:405-440.
- *Abou-Donia MB, Lapadula DM, Campbell G, et al.1985 The synergism of *n*-hexane-induced neurotoxicity by methyl isobutyl ketone following subchronic (90 days) inhalation in hens: Induction of hepatic microsomal cytochrome P-450. *Toxicol Appl Pharmacol* 81(1):1-16.
- *Abou-Donia MB, Lapadula DM, Suwita E.1988. Cytoskeletal proteins as targets for organophosphorous compound and aliphatic hexacarbon-induced neurotoxicity. *Toxicology* 49:469-477.
- *Abou-Donia MB, Makkawy HA, Graham DG.1982. The relative neurotoxicities of *n*-hexane, methyl *n*-butyl ketone, 2,5-hexanediol, and 2,5-hexanedione following oral or intraperitoneal administration in hens. *Toxicol Appl Pharmacol* 62(3):369-389.
- *ACGIH.1996. Threshold limit values for chemical substances and physical agents and biological exposure indices for 1995-1996. American Conference of Governmental Industrial Hygienists, Cincinnati, OH.
- *Adinolfi M.1985. The development of the human blood-CSF-brain barrier. *Developmental Medicine & Child Neurology* 27:532-537.
- *Ahearn DG, Crow SA, Simmons RB, et al.1996. Fungal colonization of fiberglass insulation in the air distribution system of a multi-story office building: VOC production and possible relationship to a sick building syndrome. *J Ind Microbial* 16:280-285.
- *Allen N, Mendell JR, Billmaier DJ, et al.1975. Toxic polyneuropathy due to methyl *n*-butyl ketone. *Arch Neurol* 32:209-218.
- *Altenkirch H, Mager J, Stoltenburg G, et al.1977. Toxic polyneuropathies after sniffing a glue thinner. *J Neurol* 214:137-152.
- *Altenkirch H, Wagner HM, Stoltenburg G, et al.1982. Nervous system responses of rats to subchronic inhalation of *n*-hexane and *n*-hexane + methyl-ethyl-ketone mixture. *J Neurol Sci* 57:209-219.
- *Altenkirch H, Wagner HM.1982. Potentiation of hexacarbon-neurotoxicity by methyl-ethyl-ketone (MEK) and other substances: Clinical and experimental aspects. *Neurobehav Toxicol Teratol* 4:623-627.
- *Altman PK, Dittmer DS.1974. In: *Biological handbooks: Biology data book, Volume III*, second edition. Bethesda, MD: Federation of American Societies for Experimental Biology, 1987-2008, 2041.

* Cited in text

8. REFERENCES

- *Amoore JE, Hautala E.1983. Odor as an aid to chemical safety: Odor thresholds compared with threshold limit values and volatilities for 214 industrial chemicals in air and water dilution. *J Appl Toxicol* 3(6):272-290.
- *Andersen ME, Krishnan K.1994. Relating *in vitro* to *in vivo* exposures with physiologically-based tissue dosimetry and tissue response models. In: H. Salem, ed. Current concepts and approaches on animal test alternatives. U.S. Army Chemical Research Development and Engineering Center, Aberdeen Proving Ground, Maryland.
- *Andersen ME, MacNaughton MG, Clewell HJ, et al.1987. Adjusting exposure limits for long and short exposure periods using a physiological pharmacokinetic model. *Am Ind Hyg Assoc J* 48(4):335-343.
- *Anlauf KG, Bottenheim JW, Brice KA.1985. Measurement of atmospheric aerosols and photochemical products at a rural site in SW Ontario. *Atmos Environ* 19(11):1859-1870.
- *Ashby J.1985. Fundamental structural alerts to potential carcinogenicity or non-carcinogenicity. *Environ Mutagen* 7:919-921.
- *Ashley DL, Bonin MA, Cardinali FL.1992. Determining volatile organic compounds in human blood from a large sample production by using purge and trap gas chromatography-mass spectrometry. *Anal Chem* 64(9):1021-1029.
- *Ashley DL, Bonin MA, Cardinali FL, et al.1994. Blood concentration of volatile organic compounds *in* a nonoccupationally exposed US population and in groups with suspected exposure. *Clin Chem* 40(7):1401-1409.
- *ASTER.1995. ASTER Ecotoxicity Profile: *n*-Hexane. Duluth, MN: U.S. EPA Office of Research and Development, National Health and Environmental Effects Research Laboratory, Mid-Continent Ecology Division.
- *Atkinson R.1985. Kinetics and mechanisms of the gas-phase reactions of the hydroxyl radical with organic compounds under atmospheric conditions. *Chem Rev* 85:69-201.
- *Atkinson R, Aschman SM, Carter WPL.1982. Kinetics of the reactions of OH radicals with *n*-alkanes at 299K. *Int J Chem Kinetics* 14:781-788.
- *Atkinson R, Carter WPL.1984. Kinetics and mechanisms of the gas phase reactions of ozone with organic compounds under atmospheric conditions. *Chem Rev* 84:437-470.
- *ATSDR.1989. Decision guide for identifying substance-specific data needs related to toxicological profiles. Agency for Toxic Substances and Disease Registry, Division of Toxicology, Atlanta, GA.
- *ATSDR.1991. Toxicological profile for 2-hexanone. Agency for Toxic Substances and Disease Registry. Public Health Service. U.S. Department of Health and Human Services. Atlanta, GA. TP-91/18.
- *ATSDR/CDC.1990. Subcommittee report on biological indicators of organ damage. Agency for Toxic Substances and Disease Registry, Centers for Disease Control and Prevention, Atlanta, GA.

8. REFERENCES

- *Bachmann MO, De Beer Z, Myers JE.1993. *n*-Hexane neurotoxicity in metal can manufacturing workers. *Occup Med* 43:149-154.
- *Baelum J, Molhave L, Hansen SH, et al.1998. Metabolic interaction between toluene, trichloroethylene and *n*-hexane in humans. *Stand J Work Environ Health* 24:30-37.
- *Baker TS Rickert DE.1981. Dose-dependent uptake, distribution, and elimination of inhaled *n*-hexane in the Fischer-344 rat. *Toxicol Appl Pharmacol* 61(3):414-422.
- *Barnes DG, Dourson M.1988. Reference dose (RfD): Description and use in health risk assessments. U.S. Environmental Protection Agency. *Regul Toxicol Pharmacol* 8:471-486.
- *Barrefors G, Petersson G.1993. Assessment of ambient volatile hydrocarbons from tobacco smoke and from vehicle emissions. *J Chromatogr* 643:71-76.
- *Bartolucci GB, Perbellini L, Gori GP, et al.1986. Occupational exposure to solvents: Field comparison of active and passive samplers and biological monitoring of exposed workers. *Ann Occup Hyg* 30(3):295-306.
- *Bavazzano P, Apostoli P, Balducci C, et al.1998. Determination of urinary 2,5-hexanedione in the general Italian population. *Int Arch Occup Environ Health* 71(4):284-288.
- *Bayer C.1995. Beware of fungus among us: Emissions from mold and fungus may be culprits in indoor air problems. *Georgia Tech Research News*, August 3, 1995. Atlanta GA: Institute of Technology.
- *Belkin F, Hable MA.1988. Analysis of gasoline in water using a stripping preconcentration procedure. *Bull Environ Contam Toxicol* 40:244-248.
- *Bhagya S, Srinivas H.1992. Extraction of soybean with hexane-acetic acid: Effect on oil quality. *Food Chem* 44:123-125.
- *Bianchi AP, Varnoy MS, Phillips J.1991. Analysis of volatile organic compounds in estuarine sediments using dynamic headspace and gas chromatography mass spectrometry. *J Chromatogr* 542:413-450.
- *Bio/Dynamics.1995a. An inhalation oncogenicity study of commercial hexane in rats and mice--1. Rats, abridged final report. American Petroleum Institute Publication TR 404 41-332319
- *Bio/Dynamics.1995b. An inhalation oncogenicity study of commercial hexane in rats and mice--2. Mice, abridged final report. American Petroleum Institute Publication TR 405 41-33232.
- *Bio/Dynamics Inc.1978. 26 Week inhalation toxicity study of *n*-hexane in the rat. Unpublished report prepared for the American Petroleum Institute, Washington, DC. EPA -FYI-AX-1081-0137.
- *Bishop GA, Zhang Y, McLaren SE, et al.1994. Enhancement of remote sensing for vehicle emissions in tunnels. *Air & Waste* 44:169-75.
- *Biziuk M, Namiesnik J, Czerwinski J et al.1996. Occurrence and determination of organic pollutants in tap and surface waters of the Gdansk district. *J Chromatogr A* 733:171-183.

8. REFERENCES

- *Bottenheim JW, Shepherd MF.1995. C2-C6 Hydrocarbon measurements at four rural locations across Canada. *Atmospheric Environment* 29(6):647-664.
- *Bouhamra WS.1995. Estimation of volatile organic compounds in Kuwaiti houses after the Gulf War. *Environmental Pollution* 90(1):121-125.
- *Brosseau J, Heitz M.1994. Trace gas compound emissions from municipal landfill sanitary sites. *Atmos Environ* 28(2):285-293.
- *Brugnone F, Maranelli G, Romeo L, et al.1991. Ubiquitous pollution by *n*-hexane and reference biological levels in the general population. *Int Arch Occup Environ Health* 63(3):157-160.
- *Brugnone F, Perbellini L, Giulaiari C, et al.1994. Blood and urine concentrations of chemical pollutants in the general population. *Med Lav* 85:370-389.
- *Bus JS, Deyo D, Cox M.1982. Dose-dependent disposition of *n*-hexane in F-344 rats after inhalation exposure. *Fund Appl Toxicol* 2(5):226-229.
- *Bus JS, White EL, Gillies PJ, et al.1981. Tissue distribution of *n*-hexane, methyl *n*-butyl ketone, and 2,5-hexanedione in rats after single or repeated inhalation exposure to *n*-hexane. *Drug Metab Dispos* 9(4):386-387.
- *Bus JS, White EL, Tyl RW, et al.1979. Perinatal toxicity and metabolism of *n*-hexane in Fischer-344 rats after inhalation exposure during gestation. *Toxicol Appl Pharmacol* 51(2):295-302.
- *Cao X-L, Hewitt CN.1993. Passive sampling and gas chromatographic determination of low concentrations of reactive hydrocarbons in ambient air with reduction gas detector. *J Chromatogr* 648:191-197.
- *Cardona A, Marhuenda D, Marti J, et al.1993. Biological monitoring of occupational exposure to *n*-hexane by measurement of urinary 2,5-hexanedione. *Int Arch Occup Environ Health* 65:71-74.
- *Cardona A, Marhuenda D, Prieto MJ, et al.1996. Behaviour of urinary 2,5-hexanedione in occupational co-exposure to *n*-hexane and acetone. *Int Arch Occup Environ Health* 68(2):88-93.
- *Cavender FL, Casey HW, Salem H, et al.1984. A 13-week vapor inhalation study of *n*-hexane in rats with emphasis on neurotoxic effects. *Fund Appl Toxicol* 4:191-201.
- *Chan C, Liu S, Her G.1994. Office workers exposure to volatile organic compounds while commuting and working in Taipei City. *Atmos Environ* 28(14):2351-2359.
- *Chang AP, England JD, Garcia CA, et al.1998. Focal conduction block in *n*-hexane polyneuropathy. *Muscle and Nerve* 21:964-969.
- *Chang CM, Yu CW, Fong KY, et al.1993. *n*-Hexane neuropathy in offset printers. *J Neurol Neurosurg Psychiatry* 56:538-542.
- *Chapin RE, Norton RM, Popp JA, et al.1982. The effects of 2,5-hexanedione on reproductive hormones and testicular enzyme activities in the F-344 rat. *Toxicol Appl Pharmacol* 62:262-272.

8. REFERENCES

- CIIT.1977. Current status report No.1. *n*-Hexane. Chemical Industry Institute of Toxicology, Research Triangle Park, NC., Feb. 4, 1977.
- CIIT.1982. Ninety-day vapor inhalation toxicity study on *n*-hexane in albino rats. Unpublished report prepared for the Chemical Industry Institute of Toxicology by ToxiGenics Inc. CIIT Docket No.10242. Chemical Industry Institute of Toxicology, Research Triangle Park, NC.
- *Clewell HJ III, Andersen M.1985. Risk assessment extrapolations and physiological modeling. *Toxicol Ind Health* 1(4):111-131.
- *Coates M, Connell DW, Barron DM.1985. Aqueous solubility and octanol to water partition coefficients of aliphatic hydrocarbons. *Environ Sci Technol* 19:628-632.
- Yonkerton EJ, Wan PJ, Richard OA.1995. Hexane and heptane as extraction solvents for cottonseed: A laboratory-scale study. *J Am Oil Chem Soc* 72:963-965.
- *Cooper DA, Peterson K, Simpson D.1996. Hydrocarbon PAH and PCB emissions from ferries: A case study in the Skagerak Kattégatt oresund region. *Atmos Environ* 30(14):2463-2473.
- *Couri D, Abdel-Rahman MS, Hetland LB.1978. Biotransformation of *n*-hexane and methyl *n*-butyl ketone in guinea pigs and mice. *Am Ind Hyg Assoc J* 39(4):295-300.
- *Crawford DW, Bonnevie NL, Wenning RJ.1995. Sources of pollution and sediment contamination in Newark Bay, New Jersey. *Ecotoxicol Environ Safety* 30:85-100.
- *Creaser C, Welch J, Bishop K.1983. Letters to the editor. *n*-Hexane in petroleum ether fractions. *Ann Occup Hyg* 27(2):229-230.
- *Crosbie SJ, Blain PG, Williams FM.1997. Metabolism of *n*-hexane by rat liver and extrahepatic tissues and the effect of cytochrome P-450 inducers. *Hum Exp Toxicol* 16:131-137.
- *Daisey JM, Hodgson AT, Fisk WJ, et al.1994. Volatile Organic Compounds in Twelve California Office Buildings: Classes, Concentrations and Sources. *Atmospheric Environment* 28(22):3557-3562.
- *De Martino C, Malorni W, Amantini MC. et al.1987. Effects of respiratory treatment with *n*-hexane on rat testis morphology. I. A light microscopic study. *Exp Mol Pathol* 46(2):199-216.
- *DeCaprio AP, O'Neill EA.1985. Alterations in rat axonal cytoskeletal proteins induced by *in vitro* and *in vivo* 2,5-hexanedione exposure. *Toxicol Appl Pharmacol* 78:235-247.
- *DeCaprio AP, Olajos EJ, Weber P, et al.1982. Covalent binding of a neurotoxic *n*-hexane metabolite: conversion of primary amines to substituted pyrrole adducts by 2,5-hexanedione. *Toxicol Appl Pharmacol* 65:440-450.
- *DeLuchi MA.1993. Emissions from the production, storage, and transport of crude oil and gasoline. *Air & Waste* 43:1486-1495.
- Dominguez H, Nunez MJ, Lema JM.1995. Enzyme-assisted hexane extraction of soya bean oil. *Food Chem* 54:223-231.

8. REFERENCES

- *DOT.1990. Department of Transportation. Code of Federal Regulations. 49 CFR 172.101.
- *Dunnick JK, Graham DG, Yang RS, et al.1989. Thirteen-week toxicity study of *n*-hexane in B6C3F1 mice after inhalation exposure. *Toxicology* 57(2):163-172.
- *Eiceman GA,McConnon JT, Zaman M, et al.1986. Hydrocarbons and aromatic hydrocarbons in groundwater surrounding an earthen waste disposal pit for produced water in the Duncan oil field of New Mexico. Groundwater Hazardous Waste Bureau, Environmental Improvement Division, Environment and Health Dept, State of New Mexico, Santa Fe.
- *EPA.1980. Ambient water quality criteria for chlorinated benzenes. U.S. Environmental Protection Agency, Office of Water, Regulations and Standards, Washington, DC. EPA 440/5-80-028, NTIS No. PB81-117392.
- *EPA.1985. Standards for the management of specific hazardous wastes and specific types of hazardous waste management facilities. U.S. Environmental Protection Agency. Code of Federal Regulations. 40 CFR 266.
- *EPA.1987a. Exposure analysis modeling system (EXAMSII). Center for Exposure Assessment Modeling, Ecosystems Research Division, National Exposure Research Laboratory, Office of Research and Development. U. S. Environmental Protection Agency. Athens, GA.
- *EPA.1987b. Bulk organic chemicals. Applicability; description of the bulk organic chemicals subcategory. U. S. Environmental Protection Agency. Code of Federal Regulations. 40 CFR 414.70.
- *EPA.1988. Compendium of methods for the determination of toxic organic compounds in ambient air. U. S. Environmental Protection Agency, U. S Department of Commerce, National Technical Information Service . Springfield VA.
- *EPA.1990. Standards of performance for volatile organic compounds (VOC) emissions from synthetic organic chemical manufacturing industry (SOCMI) distillation operation. U. S. Environmental Protection Agency. Code of Federal Regulations. 40 CFR 60.667.
- *EPA.1991. Alpha 2y-globulin: association with chemically induced renal toxicity and neoplasia in the male rat. Risk Assessment Forum U.S. Environmental Protection Agency, Washington DC. EPA/625/3-91/019F.
- *EPA.1993a. U.S. Environmental Protection Agency. Code of Federal Regulations. 40 CFR 302.4.
- *EPA.1993b. U.S. Environmental Protection Agency. Code of Federal Regulations. 40 CFR 60.707, Subpart RRR.
- *EPA.1994a. U.S. Environmental Protection Agency. Federal Register Notice. 59 FR 1788.
- *EPA.1994b. U.S. Environmental Protection Agency. Code of Federal Regulations. 40 CFR 63.100, subpart F.
- *EPA.1994~. U.S. Environmental Protection Agency. Code of Federal Regulations. 40 CFR 63.106.

8. REFERENCES

- *EPA.1994d. U.S. Environmental Protection Agency. Code of Federal Regulations. 40 CFR 63, Subpart G, Appendix, Tables 8,9, and 34.
- *EPA.1994e. U.S. Environmental Protection Agency. Federal Register Notice. 59 FR 61432.
- *EPA.1994f. U.S. Environmental Protection Agency. Federal Register Notice. 59 FR 9808.
- *EPA .1994g. Health Effects Notebook for Hazardous Air Pollutants. Durham, NC: U.S. EPA, Office of Air Quality Planning and Standards, Air Risk Information Support Center.
- *EPA.1994h. Automobile Emissions: an Overview. EPA 400-F-92-007. Ann Arbor, MI: U.S. EPA, Office of Mobile Sources, National Vehicle and Fuel Emissions Laboratory.
- *EPA.1994i. Method 0030. Volatile organic sampling train. Method Status Table SW-846, third edition updates I, II, IIA and IIB. U. S. Environmental Protection Agency.
- *EPA.1994j. Health effects notebook for hazardous air pollutants. U.S. Environmental Protection Agency.
- *EPA.1995a. U.S. Environmental Protection Agency. Code of Federal Regulations. 40 CFR 63, Subpart CC, Appendix, Tables 1, 5, and 7.
- *EPA.1995b. U.S. Environmental Protection Agency. Code of Federal Regulations. 40 CFR 63.800, Subpart JJ.
- *EPA.1995c. U.S. Environmental Protection Agency. Federal Register Notice. 60 FR 21592.
- *EPA.1995d. Universal Treatment Standards. U. S. Environment Protection Agency. 60 FR 242.
- *EPA.1995e. Hazadous waste management system; carbamate production identification and listing quantities. Final Rule. U.S. Environmental Protection Agency. Federal Register. 60 FR 7824. February 9, 1995.
- *EPA.1995f. Toxics Chemical Release Inventory Reporting Form R and instructions: Revised 1994 version. EPA 745-K-95-051. Washington DC: U. S. EPA. Office of Pollution Prevention and Toxics.
- *EPA.1995g. Toxics release inventory: reporting modifications beginning with 1995 reporting year. U.S. Environmental Protection Agency. EPA 745-R-95-009.
- *EPA.1996a. U.S. Environmental Protection Agency. Code of Federal Regulations. 40 CFR 63.506, Subpart U.
- *EPA.1996b. U.S. Environmental Protection Agency. Code of Federal Regulations. 40 CFR 63.698, Subpart DD.
- *EPA.1996c. Proposed air toxics regulation for the printing and publishing industry. Air Toxics Regulations: Printing and Publishing. U.S. Environmental Protection Agency, Office of Air Quality Planning and Standards. Durham, NC.

8. REFERENCES

- *EPA.1996d. Understanding the hazardous waste rule: A handbook for small business. EPA530-K-95-001 (1996 Update). Washington, DC: U.S. Environmental Protection Agency.
- *EPA.1996e. National emission standards for hazardous air pollutant emissions: group I polymers and resins. Final Rule. Environmental Protection Agency. Federal Register. 61 FR 46906. September 5, 1997.
- *EPA.1996f. Drinking water regulations and health advisories. U.S. Environmental Protection Agency. Office of Water.
- *Ervin ME, Manske MG.1990. Petroleum distillates and turpentine. In: Haddad LM, Winchester JF, eds. Clinical management of poisoning and drug overdose. 2nd edition. Philadelphia, PA: W.B. Saunders Company, 1177-1186.
- *Farmer TH.1996. Occupational hygiene limits for hydrocarbon solvents. *Ann Occup Hyg* 40(2):237-242.
- *Fedtke N, Bolt HM.1986a. Detection of 2,5-hexanedione in the urine of persons not exposed to *n*-hexane. *Int Arch Occup Environ Health* 57:143-148.
- *Fedtke N, Bolt HM.1986b. Methodological investigations on the determination of *n*-hexane metabolites in urine. *Int Arch Occup Environ Health* 57:149-158.
- *Fedtke N, Bolt HM.1987. The relevance of 4,5-dihydroxy-2-hexanone in the excretion kinetics of *n*-hexane metabolites in rat and man. *Arch Toxicol* 61:131-137.
- *Feenstra S, Mackay DM, Cherry JA.1991. A method for assessing residual NAPL based on organic chemical concentrations in soil samples. *Ground Water Monitoring Review* 11(2):128-136.
- *Fellin P, Otson R.1994. Assessment of the influence of climatic factors on concentration levels of volatile organic compounds (VOCs) in Canadian homes. *Atmos Environ* 28(22):3581-3586.
- *Filser JG, Bolt HM, Muliawan H, et al, 1983. Quantitative evaluation of ethane and *n*-pentane as indicators of lipid peroxidation *in vivo*. *Arch Toxicol* 52:135-147.
- *Filser JG, Peter H, Bolt HM, et al.1987. Pharmacokinetics of the neurotoxin *n*-hexane in rat and man. *Arch Toxicol* 60:77-80.
- *Firestone D.1997. Personal communication.
- *Fisher J, Mahle D, Bankston L, et al.1997. Lactational transfer of volatile chemicals in breast milk. *Am Ind Hyg Assoc J* 58(6):425-431.
- *Foman SJ.1966. Body composition of the infant (Part I: The male reference infant). In: Falkner F, editor. Human development. Philadelphia, PA: WB Saunders, 239-246.
- *Fornan, SJ, Haschke F, Ziegler EE et al.1982. Body composition of reference children from birth to age 10 years. *American Journal of Clinical Nutrition* 35 :1169-1175.

8. REFERENCES

- *Frontali N, Amantini MC, Spagnolo AM, et al.1981. Experimental neurotoxicity and urinary metabolites of the C5-C7 aliphatic hydrocarbons used as glue solvents in shoe manufacture. Clin Toxicol 18(12):1357-1367.
- *FSTRAC.1990. Summary of state and federal drinking water standards and guidelines. U.S. Environmental Protection Agency. Chemical Communication Subcommittee, Federal State Toxicology and Regulatory Alliance Committee (FSTRAC).
- *FSTRAC.1995. Summary of state and federal drinking water standards and guidelines. U.S. Environmental Protection Agency. Chemical Communications Subcommittee, Federal State Toxicology and Regulatory Alliance Committee.
- *Fukui Y, Doskey PV.1996. An enclosure technique for measuring nonmethane organic compound emissions from grasslands. Journal of Environmental Quality. 25:601-610.
- *Cargas ML, Burgess RJ, Voisard DE, et al.1989. Partition coefficients of low-molecular-weight volatile chemicals in various liquids and tissues. Toxicol Appl Pharmacol 98:87-99.
- *Gentry SJ, Walsh PT.1987. Eight hour TWA personal monitoring using a diffusive sampler and short-term stain tube. Am Ind Hyg Assoc J 48(3):287-292.
- *Gillies PJ, Norton RM, Baker TS, et al.1981. Altered lipid metabolism in 2,5-hexanedione-induced testicular atrophy and peripheral neuropathy in the rat. Toxicol Appl Pharmacol 59:293-299.
- *Goodgold J, Eberstein A.1983. Motor and sensory nerve conduction measurements. In: Electrodiagnosis of neuromuscular diseases. 3rd ed. Baltimore, MD: Williams and Wilkins, 104-153.
- *Gori G, Bartolucci GB, Sturaro A, et al.1995. High performance liquid chromatographic determination of urinary 2,5- hexanedione as mono 2,4-dinitrophenylhydrazone using ultraviolet detection. J Chromatogr B 673:165-172.
- *Graham DG, Amarnath V, Valentine WM, et al.1995. Pathogenetic studies of hexane and carbon disulfide neurotoxicity. Crit Rev Toxicol 25(2):91-112.
- *Graham DG, Anthony DC, Boekelheide K, et al.1982. Studies of the molecular pathogenesis of hexane neuropathy. II. Evidence that pyrrole derivatization of lysyl residues leads to protein crosslinking. Toxicol Appl Pharmacol 64:415-422.
- *Guzelian PS, Henry CJ, Olin SS.1992. Similarities and differences between children and adults: Implications for risk assessment. International Life Sciences Institute Press, Washington, D.C.
- *Hakkola M, Saarinen L.1996. Exposure of tanker drivers to gasoline and some of its components. Ann Occup Hyg 40(1):1-10.
- *Hamilton, Bruce.1996. Gasoline frequently asked questions. INTERNET USENET, Archive Name: autos/gasoline-faq/part 1 (Document Version 1.09) <http://www.paranoia.com/~filipg/HTML>
- *Hautfenne A, Pocklington WD, Wolfe JP.1987. Determination of hexane residues in oils: Results of a collaborative study and the standardised method. Pure Appl Chem 59(11):1561-1570.

8. REFERENCES

- *HazDat.1998. Agency for Toxic Substances and Disease Registry (ATSDR). Atlanta, GA.
- *Heath JS, Koblis K, Sager SL, et al.1993. Risk assessment for total petroleum hydrocarbons. In: Kostecki PT, Calabrese EJ, eds. Hydrocarbon contaminated soils and groundwater. Vol. 3, 267-301. Chelsea, MI: Lewis Publishers.
- *Herbert R, Gerr F, Luo J, et al.1995. Peripheral neurological abnormalities among roofing workers: Sentinel case and clinical screening. Arch Environ Health 50(5):349-354.
- *Heringa JW, Huybregtse R, Van Der Linden AC.1961. *n*-Alkane oxidation by a *Pseudomonas* formation and B-oxidation of intermediate fatty acids. Antonie Van Leeuwenhoek 2751-58.
- *Hernandez JE, Machado LT, Corbella R, et al.1995. *n*-Alkanes and polynuclear aromatic hydrocarbons in fresh-frozen and pre-cooked-frozen mussels. Bull Environ Contam Toxicol 55:461-468.
- *Herskowitz A, Ishii N, Schaumburg H.1971. *n*-Hexane neuropathy: A syndrome occurring as a result of industrial exposure. N Engl J Med 285:82-85.
- *Hine CH, Zuidema HH.1970. The toxicological properties of hydrocarbon solvents. Ind Med 39:215-220.
- *Houk VS, Schaikowsky S, Claxton LD.1989. Development and validation of the spiral Salmonella assay: An automated approach to bacterial mutagenicity testing. Mutat Res 223:49-64.
- *Howd RA, Rebert CS, Dickinson J, et al.1983. A comparison of the rates of development of functional hexane neuropathy in weanling and young adult rats. Neurobehav Toxicol Teratol 5:63-68.
- *HSDB.1996. Hazardous Substances Database: *n*-Hexane. National Library of Medicine, National Toxicology Information Program, Bethesda, MD.
- *Huang C, Shih T, Cheng S, et al.1991. *n*-Hexane polyneuropathy in a ball-manufacturing factory. J Occup Med 33(2):139-142.
- *Huang J, Kato K, Shibata E, et al.1989. Effects of chronic *n*-hexane exposure on nervous system-specific and muscle-specific proteins. Arch Toxicol 63(5):381-385.
- *Hunt JR, Sitar N, Udell KS.1988. Nonaqueous phase liquid transport and cleanup:1. Analysis of mechanisms. Water Resources Research 24(8):1247-1258.
- *IARC.1979b. International Agency for Research on Cancer (IARC). Monograph on the evaluation of the carcinogenic risk of chemicals to humans: some halogenated hydrocarbons. Vol. 20, Lyon France, 155-178.
- *IARC.1987. IARC monographs on the evaluation of carcinogenic risks to humans. Supplement 7, Overall evaluation of carcinogenicity: An updating of IARC monographs (Volumes 1 to 42) Lyon, France.
- Iida M.1982. Neurophysiological studies of *n*-hexane polyneuropathy in the sandal factory. Kyoto Symposia (Elsevier Biomedical Press Supplement) 36:671-81.

8. REFERENCES

- *Imbriani M, Ghittori S, Pezzagno G, et al.1984. *n*-Hexane urine elimination and weighted exposure concentration. *Int Arch Occup Environ Health* 55:33-41.
- *IRDC.1981. Six-month continuous inhalation exposure of rats to hexane mixtures-Phase II. Unpublished study by International Research and Development Corporation, Mattawan MI. Prepared for the American Petroleum Institute, Washington DC. EPA-FYI-AX-0282-0166.
- *IRIS.1998. Integrated Risk Information System, Office of Health and Environmental Assessment, Environmental Criteria and Assesment Office, Cincinnati, OH. May 1998.
- *Ishidate M, Sofuni T, Yoshikawa K, et al.1984. Primary mutagenicity screening of food additives currently used in Japan. *Food Chem Toxicol* 22(8):623-636.
- *Isidorov VA, Zenkevich IG, Ioffe BV.1985. Volatile organic compounds in the atmosphere of forest. *Atmos Environ* 19(1):1-8.
- *Iwata M, Takeuchi Y, Hisanaga N, et al.1983. A study on biological monitoring of *n*-hexane exposure. *Int Arch Occup Environ Health* 51:253-260.
- *Jackson JR, deKechoue G, Karakaya A.1997. Letter. *Hum Exp Toxicol* 16:284-285.
- *Johanson CE.1980. Permeability and vascularity of the developing brain: Cerebellum vs cerebral cortex. *Brain Research* 190:3-16.
- *Johnson BL, Boyd J, Burg JR, et al.1983. Effects on the peripheral nervous system of workers' exposure to carbon disulfide. *Neurotoxicology* 4(1):53-66.
- *Johnson DJ, Lack L, Ibrahim S, et al.1995. Protein-bound pyrroles in rat hair following subchronic intraperitoneal injections of 2,5-hexanedione. *J Toxicol Environ Health* 45:313-324.
- *Jorgensen NK, Chor KH.1981. *n*-Hexane and its toxicologic effects: A review. *Stand J Work Environ Health* 7:157-68.
- *Kanatharana P, Chindarasamme C, Kaewnarong B.1993. Extracting solvents for pesticide residues. *J Environ Sci Health A28(10):2323-2332*.
- *Karakaya A, Yucesoy B, Burgaz S, et al.1996. Some immunological parameters in workers occupationally exposed to *n*-hexane. *Hum Exp Toxicol* 15:56-58
- *Kawai T Mizunuma K, Yasugi T.1990. The method choice for the determination of 2,5-hexanedione as an indicator of occupational exposure to *n*-hexane. *Int Arch Occup Environ Health* 62:403-408.
- *Kawai T, Yasugi T, Mizunuma K.1992. Urinalysis vs. blood analysis as a tool for biological monitoring of solvent exposure. *Toxicol Letters* 63:333-343.
- *Kawai T, Yasugi T, Mizunuma K, et al.1993. Comparative evaluation of blood and urine analysis as a tool for biological monitoring of *n*-hexane and toluene. *Int Arch Occp Environ Health* 65:S123-S126.

8. REFERENCES

- *Kim IH, Yoon SH.1990. Effect of extraction solvents on oxidative stability of crude soybean oil. J Am Oil Chem Soc 67(3):165-167.
- *Kimura ET, Ebert DM, Dodge PW.1971. Acute toxicity and limits of solvent residue of sixteen organic solvents. Toxicol Appl Pharmacol 19:699-704.
- *Klein BL, Simon JE.1986. Hydrocarbon poisonings. Pediatric Clinics of North America 33:411-419.
- *Komori M, Nishio K, Kitada M et al.1990. Fetus-specific expression of a form of cytochrome P-450 in human livers. Biochemistry 29:4430-4433.
- *Kopczynski SL, Lonneman WA, Sutterfield FD, et al.1972. Photochemistry of atmospheric samples in Los Angeles. Environmental Science & Technology 6(4):342-347.
- *Kozloski RP.1985. Simple method for concentrating volatiles in water for gas chromatographic analysis by vacuum distillation. J Chromotgr 346:408-412.
- *Krasavage WJ, O'Donoghue JL, DiVincenzo GD, et al.1980. The relative neurotoxicity of methyl-*n*-butyl ketone, *n*-hexane and their metabolites. Toxicol Appl Pharmacol 52(3):433-441.
- *Krishnan K, Andersen ME.1994. Physiologically-based pharmacokinetic modeling in toxicology. In: Wallace Hayes, ed. Principles and methods of toxicology . 3rd edition. New York, NY: Raven Press Ltd.
- *Krishnan K, Andersen ME, Clewell HJ III, et al.1994. Physiologically-based pharmacokinetic modeling of chemical mixtures. In: RSA Yang, ed. Toxicology of chemical mixtures. New York, NY: Academic Press.
- *Krost KJ, Pellizzari ED, Walburn SG, et al.1982. Collection and analysis of hazardous organic emissions. Anal Chem 54:810-817.
- *Krotoszynski BK, Bruneau GM, OWeill HJ.1979. Measurement of chemical inhalation exposure in urban population in the presence of endogenous effluents. J Anal Toxicol 3(6):225-234.
- *Ladefoged O, Hass U, Simonsen L.1989. Neurophysiological and behavioural effects of combined exposure to 2,5-hexanedione and acetone or ethanol in rats. Pharmacol Toxicol 65:372-375.
- *Ladefoged O, Perbellini L.1986. Acetone-induced changes in the toxicokinetics of 2,5-hexanedione in rabbits. Stand J Work Environ Health 12:627-629.
- *Ladefoged O, Roswall K, Larsen J-J.1994. Acetone potentiation and influence on the reversibility of 2,5-hexanedione-induced neurotoxicity studied with behavioral and morphometric methods in rats. Pharmacol Toxicol 74:294-299.
- *Lam C-W, Galen TJ, Boyd JF, et al.1990. Mechanism of transport and distribution of organic solvents in blood. Toxicol Appl Pharmacol 104:117-129.
- *Lapadula DM, Habig C, Gupta RP, et al.1991. Induction of cytochrome P450 isozymes by simultaneous inhalation exposure of hens to *n*-hexane and methyl iso-butyl ketone (MiBK). Biochem Pharmacol 41(6-7):877-883.

8. REFERENCES

- *Lapadula DM, Irwin RD, Suwita E et al.1986. Cross-linking of neurofilament proteins of rat spinal cord *in vivo* after administration of 2,5-hexanedione. J Neurochem 46:1843-1850.
- *Latimer JS, Hoffman EJ, Hoffman G, et al.1990. Sources of petroleum hydrocarbons in urban runoff. Water Air and Soil Pollution 52:1-21.
- *Lawson H.1995. Food oils and fats: Technology, utilization, and nutrition. New York, NY: Chapman Jz Hall.
- *Leahy GL, Colwell RR.1990. Microbial degradation of hydrocarbons in the environment. Microbial Rev 54(3):305-315.
- *Leeder JS, Kearns GL.1997. Pharmacogenetics in pediatrics: Implications for practice. Pediatric Clinics of North America 44:55-77.
- *Leung H.1993. Physiologically-based pharmacokinetic modeling. In: Ballantine B, Marro T, Turner T, eds. General and applied toxicology, Vol. I. New York, NY: Stockton Press, 153-164.
- *Lide DR.1994. CRC handbook of chemistry and physics. 74th edition. Boca Raton, FL: CRC Press Inc.
- *Linder RE, Strader LF, Slott VL, et al.1992. Endpoints of spermatotoxicity in the rat after short duration exposures to fourteen reproductive toxicants. Reprod Toxicol 6(6):491-505.
- *Litton Bionetics.1979. Teratology study in rats *n*-hexane. Unpublished study by Litton Bionetics Inc., Kensington MD. Prepared for the American Petroleum Institute, Washington DC. EPA-FYI-AX-O 183-0231.
- *Litton Bionetics.1980. Mutagenicity evaluation of *n*-hexane in the mouse dominant lethal assay Final report. Unpublished study by Litton Bionetics Inc., Kensington MD. Prepared for the American Petroleum Institute, Washington DC. EPA-FYI-AX-01 83-0231.
- *Loden M.1986. The *in vitro* permeability of human skin to benzene, ethylene glycol, formaldehyde, and *n*-hexane. Acta Pharmacol Toxicol 58(5):382-389.
- *Lungarella G, Barni-Comparini I, Fonzi L.1984. Pulmonary changes induced in rabbits by long-term exposure to *n*-hexane. Arch Toxicol 55:224-228.
- *Lyman WJ, Reehl WF, Rosenblatt DH.1982. Handbook of chemical property estimation methods: Environmental behavior of organic compound. New York, NY: McGraw-Hill Book Company.
- *Marks TA, Fisher PW, Staples RE.1980. Influence of *n*-hexane on embryo and fetal development in mice. Drug Chem Toxicol 3(4):393-406.
- *Mast TA, Decker JR, Clark ML, et al.1987. Inhalation developmental toxicology studies: Teratology study of *n*-hexane in rats: Final report. Department of Energy, Washington DC. NTIS No.-DE88006812. PNL-6453.

8. REFERENCES

- *Mast TA, Hackett PL, Decker JR, et al.1989a. Inhalation reproductive toxicology studies: Sperm morphology study of *n*-hexane in B6C3F1 mice. Department of Energy, Washington DC. NTIS No.-DE89000262. PNL-6672.
- *Mast TA, Rommerein RL, Evanoff JJ, et al.1989b. Inhalation reproductive toxicology studies: Male dominant lethal study of *n*-hexane in Swiss (CD-1) mice. Department of Energy, Washington DC. NTIS No.-DE89000271. PNL-6679.
- *Mast TJ, Decker JR, Stoney KH, et al.1988. Inhalation developmental toxicology studies: Teratology study of *n*-hexane in mice. Department of Energy, NTIS No. DE88012680 (PNL-6590).
- *Mathews JM, Raymer JH, Etheridge As, et al.1997. Do endogenous volatile organic chemicals measured in breath reflect and maintain CYP2E1 levels *in vivo*? *Toxicol Appl Pharmacol* 146:255-260.
- *Mayer VW, Goin CJ.1994. Induction of chromosome loss in yeast by combined treatment with neurotoxic hexacarbons and monoketones. *Mutat Res* 341:83-91.
- *McCann MF.1992. Occupational and environmental hazards in art. *Environ Res* 59:139-144.
- *McCarroll NE, Keech BH, Piper CE.1981a. A microsuspension adaptation of the *Bacillus subtilis* "ret" assay. *Environ Mutagen* 3:607-616.
- *McCarroll NE, Piper CE, Keech BH. 1981 b. An *E. coli* microsuspension assay for the detection of DNA damage induced by direct-acting agents and promutagens. *Environ Mutagen* 3:429-444.
- *McClay K, Streger SH, Steffan RJ.1995. Induction of toluene oxidation activity in *Pseudomonas mendocina* KRI and *Pseudomonas sp.* Strain ENVPCS by chlorinated solvents and alkanes. *Appl Environ Microbiol* 61(9):3479-3481.
- *McKay WA, Turner MF, Jones BMR, et al.1996. Emission of hydrocarbons from marine phytoplankton - Some results from controlled laboratory experiments. *Atmos Environ* 30(14):2583-2593.
- *McLaren R, Singleton DL, Lai JYK, et al.1996. Analysis of motor vehicle sources and their contribution to ambient hydrocarbon distributions at urban sites in Toronto during the Southern Ontario oxidants study. *Atmos Environ* 30(12):2219-2232.
- *Merck.1989. Merck index: An encyclopedia of chemicals, drugs, and biologicals.11 th ed. Budavari S, ed. Rahway NJ: Merck & Co., Inc.
- *Michael LC, Erickson MD, Parks SP, et al.1980. Volatile environmental pollutants in biological matrices with a headspace purge technique. *Anal Chem* 52:1836-1841.
- *Michael LC, Pellizzari ED, Wiseman RW.1988. Development and evaluation of a procedure for determining volatile organics in water. *Environ Sci Technol* 22(5):565-570
- .
*Montgomery JH.1991. Groundwater chemicals desk reference. Volume 2. Ann Arbor: Lewis Publishers.
- *Morgenroth E, Schroeder ED, Chang DPY, et al.1996. Nutrient limitation in a compost biofilter degrading hexane. *J Air & Waste Management Association* 46:300-308.

8. REFERENCES

- *Morsehi PL, France-Morselli R, Bossi L.1980. Clinical pharmacokinetics in newborns and infants. *Clinical Pharmacokinetics* 5:485-527.
- *Mortelmans K, Haworth S, Lawlor T, et al.1986. Salmonella mutagenicity tests. II. Results from the testing of 270 chemicals. *Environ Mutagen* 8(Suppl 7):1-119.
- *Moschonas N, Glavas S.1996. C3-C 10 Hydrocarbons in the atmosphere of Athens, Greece. *Atmos Environ* 30(15):2769-7272.
- *Mutti A, Bergamaschi E, Ghittori S, et al.1993. On the need of a sampling strategy in biological monitoring: The example of hexane exposure. *Int Arch Occup Environ Health* 65(1):S172-S176.
- *Mutti A, Cavatorta A, Lommi G , et al.1982a. Neurophysiological effects of long-term exposure to hydrocarbon mixtures. *Arch Toxicol Suppl* 5:120-124.
- *Mutti A, Falzoi M, Lucertini S, et al.1984. *n*-Hexane metabolism in occupationally exposed workers. *Br J Ind Med* 41(4):533-538.
- *Mutti A, Ferri F, Lommi G, et al.1982b. *n*-Hexane-induced changes in nerve conduction velocities and somatosensory evoked potentials. *Int Arch Occup Environ Health* 51(1):45-54.
- *Nakajima T, Elovaara E, Park SS, et al.1991. Immunochemical detection of cytochrome P450 isozymes induced in rat liver by *n*-hexane, 2-hexanone and acetyl acetone. *Arch Toxicol* 65:542-547.
- *NAS/NRC.1980. Drinking water and health: Volume3. Washington, DC: National Academy Press.
- *NAS/NRC.1989. Biologic markers in reproductive toxicology. National Academy of Sciences/National Research Council. Washington, DC: National Academy Press, 15-35.
- *NAS/NRC.1989. Biological markers in reproductive toxicology. National Research Council. Board of Environmental Studies and Toxicology. Committee on Biological Markers, pp.15-35.
- *NATICH.1992. National Air Toxics Information Clearing House (NATICH) data base report of federal, state, and local air toxics activities. Research Triangle Park, NC: U.S. Environmental Protection Agency, Office of Air Quality Planning and Standards. EPA-453\R-92-008.
- *Neeper-Bradley TL .1989a. Developmental toxicity study of commercial hexane vapor in CD(Sprague-Dawley) rats. Prepared by Bushy Run Research Center (Export, PA) for the American Petroleum Institute (API), Project Report 52-605, October 27, 1989.
- *Neeper-Bradley TL .1989b. Developmental toxicity study of commercial hexane vapor in CD-1 mice. Prepared by Bushy Run Research Center (Export, PA) for the American Petroleum Institute (API), Project Report 52-604, October 27, 1989.
- *Neligan RE.1962. Hydrocarbons in the Los Angeles atmosphere. *Arch Environ Health* 5:581-91.
- *Nelson KW, Ege JF Jr, Ross M, et al.1943. Sensory response to certain industrial solvent vapors. *J Ind Hyg Toxicol* 25:282-285.

8. REFERENCES

- *NFPA.1994. Fire protection guide to hazardous materials.11th edition. National Fire Protection Association. One Batterymarch Park, Quincy, MA 02269.
- *NIOSH.1992. NIOSH Recommendations for occupational safety and health--compendium of policy documents and statements. National Institute for Occupational Safety and Health. Department of Health and Human Services. Publication No. 92-100. Cincinnati, Ohio.
- *NIOSH.1995. NIOSH Report to Congress on workers' home contamination study conducted under the Workers' Family Protection Act. National Institute for Occupational Safety and Health. Department of Health and Human Services. Publication No. 96-192-000. Cincinnati, Ohio.
- *NOES.1991. *n*-Hexane: Numbers of potentially exposed employees from the National Occupational Exposure Database. Cincinnati, OH: National Institute for Occupational Safety.
- *NRC.1993. Pesticides in the diets of infants and children. National Research Council, Washington DC: National Academy Press.
- *NTP 1991. Toxicity studies of *n*-hexane in B6C3F1 (inhalation studies) National Toxicology Program. Research Triangle Park, NC. U.S. Department of Health and Human Services. Public Health Service. National Institutes of Health. Publication No. 91-3121.
- *Nylen P, Ebendal T, Eriksson-Nilsson M, et al.1989. Testicular atrophy and loss of nerve growth factor-immunoreactive germ cell line in rats exposed to *n*-hexane and a protective effect of simultaneous exposure to toluene or xylene. Arch Toxicol 63:296-307.
- *Nylen P, Hagman M.1994. Function of the auditory and visual systems, and of peripheral nerve, in rats after long-term combined exposure to *n*-hexane and methylated benzene derivatives. II. Xylene. Pharmacol Toxicol 74(2):124-9.
- *Nylen P, Hagman M, Johnson AC.1994. Function of the auditory and visual systems, and of peripheral nerve, in rats after long-term combined exposure to *n*-hexane and methylated benzene derivatives. I. Toluene. Pharmacol Toxicol 74(2):116-23.
- *O'Leary P, Walsh P.1995. Solid waste landfills. Madison, WI: University of Wisconsin at Madison.
- *Oliver KD, Adams JR, Daughtrey EH, et al.1996. Technique for monitoring ozone precursor hydrocarbons in air at photochemical assessment monitoring stations: Sorbent preconcentration, closed-cycle cooler cryofocusing, and GC-FID analysis. Atmos Environ 30(15):2751-2757.
- *Ong CN, Koh D, Foo SC, et al.1993. Volatile organic solvents in correction fluids: Identification and potential hazards. Bull Environ Contam Toxicol 50:787-793.
- *Ono Y, Takeuchi Y, Hisanaga N.1981. A comparative study on the toxicity of *n*-hexane and its isomers on the peripheral nerve. Int Arch Occup Environ Health 48:289-294.
- *OSHA.1974. U.S. Occupational Safety and Health Administration. Code of Federal Regulations 29 CFR 1910.1000.
- *OTA.1990. Neurotoxicology: Identifying and controlling poisons of the nervous system. Office of Technology Assessment, Washington, DC. OTA-BA-438.

8. REFERENCES

- *Otson R, Fellin P, Tran Q.1994. VOCs in representative Canadian residences. *Atmos Environ* 28(22):3563-3569.
- *Owen GM, Brozek J.1966. Influence of age, sex, and nutrition on body composition during childhood and adolescence. In: Falkner F, ed. *Human development*. Philadelphia, PA: Saunders, 222-238.
- *Pastore C, Marhuenda D, Marti J, et al.1994. Early diagnosis of *n*-hexane-caused neuropathy. *Muscle Nerve* 17(9):981-6.
- *Patten CJ, Ning SM, Lu AYH, et al.1986. Acetone-inducible cytochrome P-450: Purification, catalytic activity, and interaction with cytochrome b5. *Arch Biochem Biophys* 251:629-638.
- *Pellizzari ED, Hartwell TD, Harris BSH, et al.1982. Purgeable organic compounds in mother's milk. *Bull Environ Contam Toxicol* 28:322-328.
- *PennWell.1994. *Energy statistics sourcebook*. 9th edition. Tulsa, OK: PennWell Publishing Company.
- *Perbellini L, Brugnone F, Caretta D, et al.1985. Partition coefficients of some industrial aliphatic hydrocarbons (C5-C7) in blood and human tissues. *Br J Ind Med*. 42(3):162-167.
- *Perbellini L, Brugnone F, Faggionato G.1981. Urinary excretion of the metabolites of *n*-hexane and its isomers during occupational exposure. *Br J Ind Med*. 38(1):20-26.
- *Perbellini L, Brugnone F, Pavan I.1980. Identification of the metabolites of *n*-hexane, cyclohexane, and their isomers in men's urine. *Toxicol Appl Pharmacol* 53:220-229.
- *Perbellini L, Marhuenda Amoros D, Cardona Llorens A, et al.1990a. An improved method of analysing 2,5-hexanedione in urine. *Brit J Ind Med* 47:421-424.
- *Perbellini L, Mozzo P, Brugnone F, et al.1986. Physiologicomathematical model for studying human exposure to organic solvents: Kinetics of blood/tissue *n*-hexane concentrations and of 2,5-hexanedione in urine. *Brit J Ind Med* 43(11):760-768.
- *Perbellini L, Mozzo P, Olivato D, et al.1990b. Dynamic biological exposure indexes for *n*-hexane and 2,5-hexanedione, suggested by a physiologically based pharmacokinetic model. *Am Ind Hyg Assoc J* 51(7):356-362.
- *Perbellini L, Pezzoli G, Brugnone F, et al.1993. Biochemical and physiological aspects of 2,5-hexanedione: Endogenous or exogenous product? *Int Arch Occup Environ Health* 65:49-52.
- *Periago FJ, Luna A, Morente A, et al.1991. Design and evaluation of an exhaled breath sampler for biological monitoring of organic solvents. *J Appl Toxicol* 12(2):91-96.
- *Periago JF, Cardona A, Marhuenda D, et al.1993. Biological monitoring of occupational exposure to *n*-hexane by exhaled air analysis and urinalysis. *Int Arch Occup Environ Health* 65:275-278.
- *Perocco P, Bolognesi S, Alberghini W.1983. Toxic activity of seventeen industrial solvents and halogenated compounds on human lymphocytes cultured *in vitro*. *Toxicol Lett* 16:69-75.

8. REFERENCES

- *Pezzoli G, Antonini A, Barbieri S, et al.1995. *n*-Hexane-induced Parkinsonism: Pathogenetic hypothesis. *Movement Disorders* 10:279-282.
- *Potter TL.1993. Analysis of petroleum contaminated soil and water: An overview. In: Calabrese EJ, Kostecki PT, eds. *Principles and practices for petroleum contaminated soils*. Ann Arbor, MI: Lewis Publishers, 1-14.
- *Pryor GT, Rebert CS.1992. Interactive effects of toluene and hexane on behavior and neurophysiologic responses in Fischer-344 rats. *Neurotoxicology* 13:225-234.
- *Pyle SJ, Amarnath V, Graham DG et al.1993. Decreased levels of the high molecular weight subunit of neurofilaments and accelerated neurofilament transport during the recovery phase of 2,5-hexanedione exposure. *Cell Motil Cytoskeleton* 26(2):133-143.
- *Rastogi SC.1993. Organic solvent levels in model and hobby glues. *Bull Environ Contam Toxicol* 51:501-507.
- *Raymer JH, Pellizzari ED.1996. Estimation of recent exposures to volatile organic chemicals using alveolar air measurements. *Toxicol Ind Health* 12:201-20.
- *Raymer JH, Thomas KW, Pellizzari ED, et al.1994. A breath sampling device for measuring human exposure to volatile organic compounds in microgravity. *Aviation, Space and Environmental Medicine* 353-360.
- *Rebert C, Sorenson.1983. Concentration-related effects of *n*-hexane on evoked responses from brain and peripheral nerve of the rat. *Neurobehav Toxicol Teratol* 5:69-76.
- *Roberts MT, Etherington D.1996. *Bookbinding and the conservation of books: A dictionary of descriptive terminology*. Menlo Park, CA: Electronic Edition, Stanford University
<http://palimnset.stanford.edu/don/don.html>
- *Roberts NJ, Burton HR.1994. Volatile compounds in Meromictic Antarctic lakes and basins *Chemosphere* 29(8):1627-1637.
- *Robertson P, White EL, Bus JS.1989. Effects of methyl ethyl ketone pretreatment on hepatic mixed-function oxidase activity and on *in vivo* metabolism of *n*-hexane. *Xenobiotica* 19(7):721-729.
- *Rosenberg E, Legmann R, Kushmaro A, et al.1992. Petroleum bioremediation: A multiphase problem. *Biodegradation* 3:337-350.
- *RTECS.1997. *Registry of Toxic Effects of Chemical Substances (RTECS)*. National Institute for Occupational Safety and Health (NIOSH). Computer database online.
- *Sack TM, Steele DH, Hammerstrom K, et al.1992. A survey of household products for volatile organic compounds. *Atmos Environ* 26A:1063-1070.
- *Sanagi S, Seki Y, Sugimoto K, et al.1980. Peripheral nervous system functions of workers exposed to *n*-hexane at a low level. *Int Arch Occup Environ Health* 47(1):69-79.

8. REFERENCES

- *Sauer TC, Brown JS, Boehm PD, et al. 1993. Hydrocarbon source identification and weathering characterization of intertidal and subtidal sediments along the Saudi Arabian coast after the Gulf War Oil Spill. *Marine Pollution Bulletin* 27:117-134.
- *Schaumburg HH, Spencer PS. 1976. Degeneration in central and peripheral nervous systems produced by pure *n*-hexane: An experimental study. *Brain* 99:183-192.
- *Schubert J. 1994. Joint use of retention index and mass spectrum in postmortem test for volatile organics by headspace capillary gas chromatography with ion-trap detection. *J Chromatogr A* 674:63-71.
- *Seppalainen AM, Raitta C, Huuskonen MS. 1979. *n*-Hexane-induced changes in visual evoked potentials and electroretinograms of industrial workers. *Electroencephal Clin Neurophysiol* 47:492-498.
- *Setchell BP, Waites GMH. 1975. The blood testis barrier. In: Creep RO, Astwood EB, eds., Geiger SR, executive ed. *Handbook of physiology: Endocrinology V (Chapter 6)*. Washington DC: American Physiological Society.
- *Seto Y. 1994. Determination of volatile substances in biological samples by headspace gas chromatography. *J Chromatogr A* 674:25-62.
- *Shaw DG, Hogan TE, McIntosh DJ. 1986. Hydrocarbons in the sediments of Port Valdez, Alaska: Consequences of five years' permitted discharge. *Estuarine, Coastal and Shelf Science* 21:131-144.
- *Sieber WK, Sundin DS, Frazier TM, et al. 1991. Development, use, and availability of a job exposure matrix based on national occupational hazard survey data. *Amer J Ind Med* 20:163-174.
- *Sittig M. 1994. *World-wide limits for toxic and hazardous chemicals in air, water, and soil*. Park Ridge, NJ. Noyes Publications.
- *Speight JG. 1991. *Classification. The chemistry and technology of petroleum*. Second edition, 197-527.
- *Spencer PS, Schaumburg HH. 1977a. Ultrastructural studies of the dying-back process. III. The evolution of experimental peripheral giant axonal degeneration. *J Neuropathol Exp Neurol* 36(2):276-299.
- *Spencer PS, Schaumburg HH. 1977b. Ultrastructural studies of the dying-back process. IV. Differential vulnerability of PNS and CNS fibers in experimental central-peripheral distal axonopathies. *J Neuropathol Exp Neurol* 36(2):300-320.
- *Spencer PS, Schaumburg HH, Sabri MI, et al. 1980. The enlarging view of hexacarbon neurotoxicity. *CRC Crit Rev Toxicol* 17(4):279-356.
- *SRC. 1994a. Syracuse Research Center. Henry's Law Constant Program (HENRYWIN, version 2.50 serial H0142). Chemical Hazard Assessment Division, Environmental Chemistry Center, Syracuse, NY.
- *SRC. 1994b. Fate and transport models: Model outputs for the chemical *n*-hexane. Syracuse, NY: Syracuse Research Corporation.

8. REFERENCES

- *SRC.1995. Syracuse Research Center. Octanol-Water Partition Coefficient Program (KOWWIN, version 137, serial L0148). Chemical Hazard Assessment Division, Environmental Chemistry Center, Syracuse, NY.
- *SRI.1988.1988 Directory of chemical producers: United States of America. Menlo Park, CA: SRI International.
- *SRI.1990.1990 Directory of chemical producers: United States of America. Menlo Park, CA: SRI International.
- *SRI.1992.1992 Directory of chemical producers: United States of America. Menlo Park, CA: SRI International.
- *SRI.1994.1994 Directory of chemical producers: United States of America. Menlo Park, CA: SRI International.
- *SRI.1995.1995 Directory of chemical producers: United States of America. Menlo Park, CA: SRI International.
- *SRI.1996.1996 Directory of chemical producers: United States of America. Menlo Park, CA: SRI International.
- *Srinivas H, Swamylingappa B, Chand N.1992. Secondary extraction of soybeans using hexane-acetic acid: Effect on beany flavor removal and physiochemical properties. J Agric Food Chem 40:276-279.
- *St. Clair MB, Amarnath V, Moody MA, et al.1988. Pyrrole oxidation and protein cross-linking as necessary steps in the development of gamma-diketone neuropathy. Chem Res Toxicol 1:179-185.
- *Stelljes ME, Watkin GE.1993. Comparison of environmental impacts posed by different hydrocarbon mixtures: A need for site-specific composition analyses. In: Kostecki PT, Calabrese EJ, eds. Hydrocarbon contaminated soils and groundwater, Vol. 3. Chelsea, MI: Lewis Publishers, 549-569.
- *Stevens P.1988. Oil and gas dictionary. New York, NY: Nichols Publishing.
- *Stoltenburg-Didinger G, Altenkirch H, Wagner M.1990. Neurotoxicity of organic solvent mixtures: Embryotoxicity and fetotoxicity. Neurotoxicol Teratol 12:585-589.
- *SUCRON.1996. The SUCRON wood and cane to gasoline and hydrogen process. Clinton, LA: SUCRON, Inc.
- *Sundell J.1996. What we know, and don't know, about sick building syndrome. ASHRAE Journal 38(6):51-57.
- *Swarm RL, Laskowski DA, McCall PJ, et al.1983. A rapid method for the estimation of the environmental parameters octanol/water partition coefficient, soil sorption constant, water to air ratio, and water solubility. Residue Reviews 85:1.
- *Takeuchi Y, Hisanaga N, Ono Y, et al.1993. Modification of metabolism and neurotoxicity of hexane by co-exposure of toluene. Int Arch of Occup Environ Health 65(1):S227-S230.

8. REFERENCES

- *Takeuchi Y, Ono Y, Hisanaga N, et al.1980. A comparative study on the neurotoxicity of *n*-pentane, *n*-hexane, and *n*-heptane in the rat. *Brit J Ind Med* 37:241-247.
- *Tang Y-Z, Cheng WK, Fellin P, et al.1996. Laboratory evaluation of sampling methods for C 1 to C4 hydrocarbons. *Amer Ind Hyg Assoc J* 57:1245-250.
- *Thomas KW, Pellizzari ED, Cooper SD.199 I. Canister based method for collection and GC/MS analysis of volatile organic compounds in human breath. *J Anal Toxicol* 15:54-59.
- *Toftgard R, Haaparanta T, Eng L, et al.1986. Rat lung and liver microsomal cytochrome P-450 isozymes involved in the hydroxylation of *n*-hexane. *Biochem Pharmacol* 35(21):3733-3738.
- *Toftgard R, Halpert J, Gustafsson JA.1983. Xylene induces a cytochrome P-450 isozyme in rat liver similar to the major isozyme induced by phenobarbital. *Mol Pharmacol* 23(1):265-271.
- *TRI96.1998. Toxic Chemical Release Inventory. National Library of Medicine, National Toxicology Information Program, Bethesda, MD.
- *U.S. Congress.1986. Superfund amendments and reauthorization act of 1986. Title III--Emergency Planning and Community Right-to-Know. Ninety-ninth Congress of the United States of America.
- *U.S. Congress.1990. Clean air amendments. Title III, Hazardous Air Pollutants, Section 112(b), Hazardous Air Pollutants as Amended, October 26, 1990. One Hundred and First Congress of the United States of America, 2nd Session Report 101-952.
- *USITC.1994. Synthetic organic chemical: United States production and sales, 1992. USITC Publication 2720, February, 1994. Washington, DC: United States International Trade Commission.
- *van Engelen JG, Kezie S, de Haan W.1995. Determination of 2,5 hexanedione a metabolite of *n*-hexane, in urine evaluation and application of three analytical methods. *J Chromatogr B* 667:233-240.
- *van Engelen JGM, Rebel-deHaan W, Opdam JJG, et al.1997. Effect of coexposure to methyl ethyl ketone (MEK) on *n*-hexane in human volunteers. *Toxicol Appl Pharmacol* 144:385-395
- *Van Ert MD, Arp EW, Harris RL.1980. Worker exposures to chemical agents in the manufacture of rubber tires: Solvent vapor studies. *Am Ind Hyg Assoc J* 41(3):212-219.
- *Verma DK, Shaw DS, McLean JD.1992. An evaluation of airborne concentrations of selected hydrocarbons at an oil refinery land reclamation operation. *Ann Occup Hyg* 36(3):307-315.
- *Veulemans H, Groeseneken D, Masschelein R, et al.1987. Survey of ethylene glycol ether exposure in Belgian industries and workshops. *Am Ind Hyg Assoc J* 48(8):671-676.
- *Veulemans H, Van Vlem E, Janssens H, et al.1982. Experimental human exposure to *n*-hexane. Study of the respiratory uptake and elimination, and of *n*-hexane concentrations in peripheral venous blood. *Int Arch Occup Environ Health*. 49(3-4):251-263.

8. REFERENCES

- *Vieira I, Sonnier M, Cresteil T.1996. Developmental expression of CYP2E1 in the human liver: hypermethylation control of gene expression during the neonatal period. *European Journal of Biochemistry* 238:476-483.
- *Wadden RA, Scheff PA, Franke JE, et al.1995. VOC emission rates and emission factors for a sheetfed offset printing shop. *Am Ind Hygiene Assoc J* 56:368-376.
- *Wahlberg JE.1984. Erythema-inducing effects of solvents following epicutaneous administration to man-studied by laser doppler flowmetry. *Stand J Work Environ Health* 10:159-162.
- *Wahlberg JE, Boman A.1979. Comparative percutaneous toxicity of ten industrial solvents in the guinea pig. *Stand J Work Environ & Health* 5:345-351.
- *Wanasundara JPD, Shahidi F.1994. Alkanol-ammonia-water/hexane extraction of flaxseed. *Food Chem* 49:39-44.
- *Wang JD, Chang YC, Kao KP, et al.1986. An outbreak of n-hexane induced polyneuropathy among press proofing workers in Taipei. *Am J Ind Med* 10(2):111-118.
- *Watts JO, Holswade W.1967. Gas chromatographic determination of residual hydrocarbon solvents in solvent-extracted edible oils. *J AOAC* 50(3):718-726.
- *West JR, Smith HW, Chasis H.1948. Glomerular filtration rate, effective renal blood flow, and maximal tubular excretory capacity in infancy. *J of Pediatrics* 32a:10-18.
- *White EL, Bus JS, Heck H d'A.1979. Simultaneous determination of n-hexane, 2-hexanone and 2,5-hexanedione in biological tissues by gas chromatography mass spectrometry. *Biomedical Mass Spectrometry* 6(4):169-172.
- *WHO.1984. Guidelines for drinking-water quality: Volume I: Recommendations. Geneva, Switzerland: World Health Organization, 203-228.
- * WHO.1991. n-Hexane. Environmental health criteria 122. World Health Organization. Geneva, Switzerland.
- *Widdowson EM, Dickerson JWT.1964. Chapter 17: Chemical composition of the body. In: Comar CL and Bronner F, eds. *Mineral metabolism: An advanced treatise volume II - the elements part A*. New York, NY: Academic Press.
- *Wirier AM, Arey J, Atkinson R, et al.1992. Emission rates of organics from vegetation in California's Central valley. *Atmos Environ* 26A(14):2647-2659.
- *Wang P SH, Cooks RG, Cisper ME, et al.1995. On-line in situ analysis with membrane introduction MS. *Environ Sci Technol* 29(5):215A-218A.
- *Xu YH, Mitra S.1994. Continuous monitoring of volatile organic compounds in water using on-line membrane extraction and microtrap gas chromatography system. *J Chromatogr* 688:171-180.

8. REFERENCES

- *Yamamura Y.1969. *n*-Hexane polyneuropathy. *Folia Psychiatrica et Neurologica Japonica* 23(1):45-57.
- *Yang Yu, Hawthorne B, Miller DJ.1995. Comparison of sorbent and solvent trapping after supercritical fluid extraction of volatile petroleum hydrocarbons from soil. *J Chromatogr A* 699:265-276.
- *Zhao WY, Misumi J, Yasui T, et al.1998. Effects of methyl ethyl ketone, acetone, or toluene coadministration on 2,5-hexanedione concentration in the sciatic nerve, serum, and urine of rats. *Int Arch Occup Environ Health* 71:236-244.
- *Zhu M, Spink DC, Yan B, et al.1995. Inhibition of 2,5-hexanedione-induced protein cross-linking by biological thiols: Chemical mechanisms and toxicological implications. *Chem Res Toxicol* 8:764-771.
- *Ziegler EE, Edwards BB, Jensen RL et al.1978. Absorption and retention of lead by infants. *Pediatr Res* 12:29-34.
- *Zielinska B, Sagebiel JC, Harshfield G, et al.1996. Volatile organic compounds up to C20 emitted from motor vehicles: Measurement methods. *Atmos Environ* 30(12):2269-2286.

9. GLOSSARY

Absorption-The taking up of liquids by solids, or of gases by solids or liquids.

Acute Exposure-Exposure to a chemical for a duration of 14 days or less, as specified in the Toxicological Profiles.

Adsorption-The adhesion in an extremely thin layer of molecules (as of gases, solutes, or liquids) to the surfaces of solid bodies or liquids with which they are in contact.

Adsorption Coefficient (K_{oc})-The ratio of the amount of a chemical adsorbed per unit weight of organic carbon in the soil or sediment to the concentration of the chemical in solution at equilibrium.

Adsorption Ratio (Kd)-The amount of a chemical adsorbed by a sediment or soil (i.e., the solid phase) divided by the amount of chemical in the solution phase, which is in equilibrium with the solid phase, at a fixed solid/solution ratio. It is generally expressed in micrograms of chemical sorbed per gram of soil or sediment.

Benchmark Dose (BMD)-is usually defined as the lower confidence limit on the dose that produces a specified magnitude of changes in a specified adverse response. For example, a BMD₀₁ would be the dose at the 95% lower confidence limit on a 10% response, and the benchmark response (BMR) would be 10%. The BMD is determined by modeling the dose response curve in the region of the dose response relationship where biologically observable data are feasible.

Benchmark Dose Model-A statistical dose-response model applied to either experimental toxicological or epidemiological data to calculate a BMD.

Bioconcentration Factor (BCF)-The quotient of the concentration of a chemical in aquatic organisms at a specific time or during a discrete time period of exposure divided by the concentration in the surrounding water at the same time or during the same period.

Biomarkers-are broadly defined as indicators signaling events in biologic systems or samples. They have been classified as markers of exposure, markers of effect, and markers of susceptibility.

Cancer Effect Level (CEL)-The lowest dose of chemical in a study, or group of studies, that produces significant increases in the incidence of cancer (or tumors) between the exposed population and its appropriate control.

Carcinogen-A chemical capable of inducing cancer.

Case-Control Study-A type of epidemiological study which examines the relationship between a particular outcome (disease or condition) and a variety of potential causative agents (such as toxic chemicals). In a case-controlled study, a group of people with a specified and well-defined outcome is identified and compared to a similar group of people without this outcome.

Case Report--describes a single individual with a particular disease or exposure. These may suggest some potential topics for scientific research but are not actual research studies.

Case Series-describes the experience of a small number of individuals with the same disease or exposure. These may suggest potential topics for scientific research but are not actual research studies.

9. GLOSSARY

Ceiling Value-A concentration of a substance that should not be exceeded, even instantaneously.

Chronic Exposure--Exposure to a chemical for 365 days or more, as specified in the Toxicological Profiles.

Cohort Study-A type of epidemiological study of a specific group or groups of people who have had a common insult (e.g., exposure to an agent suspected of causing disease or a common disease) and are followed forward from exposure to outcome. At least one exposed group is compared to one unexposed group.

Cross-sectional Study-A type of epidemiological study of a group or groups which examines the relationship between exposure and outcome to a chemical or to chemicals at one point in time.

Data Needs-Substance-specific informational needs that if met would reduce the uncertainties of human health assessment.

Developmental Toxicity-The occurrence of adverse effects on the developing organism that may result from exposure to a chemical prior to conception (either parent), during prenatal development, or postnatally to the time of sexual maturation. Adverse developmental effects may be detected at any point in the life span of the organism.

Dose-Response Relationship-The quantitative relationship between the amount of exposure to a toxicant and the incidence of the adverse effects.

Embryotoxicity and Fetotoxicity- Any toxic effect on the conceptus as a result of prenatal exposure to a chemical; the distinguishing feature between the two terms is the stage of development during which the insult occurs. The terms, as used here, include malformations and variations, altered growth, and *in utero* death.

Environmental Protection Agency (EPA) Health Advisory- An estimate of acceptable drinking water levels for a chemical substance based on health effects information. A health advisory is not a legally enforceable federal standard, but serves as technical guidance to assist federal, state, and local officials.

Epidemiology-The investigation of factors that determine the frequency and distribution of disease or other health-related conditions within a defined human population during a specified period.

Genotoxicity-A specific adverse effect on the genome of living cells that, upon the duplication of affected cells, can be expressed as a mutagenic, clastogenic or carcinogenic event because of specific alteration of the molecular structure of the genome.

Half-life-A measure of rate for the time required to eliminate one half of a quantity of a chemical from the body or environmental media.

Immediately Dangerous to Life or Health (IDLH)-The maximum environmental concentration of a contaminant from which one could escape within 30 minutes without any escape-impairing symptoms or irreversible health effects.

Incidence-The ratio of individuals in a population who develop a specified condition to the total number of individuals in that population who could have developed that condition in a specified time period.

9. GLOSSARY

Intermediate Exposure-Exposure to a chemical for a duration of 15-364 days, as specified in the Toxicological Profiles.

Immunological Effects-Functional changes in the immune response.

Immunologic Toxicity-The occurrence of adverse effects on the immune system that may result from exposure to environmental agents such as chemicals.

In vitro-Isolated from the living organism and artificially maintained, as in a test tube.

In Vivo-Occurring within the living organism.

Lethal Concentration_(LO)(L_{LO})-The lowest concentration of a chemical in air which has been reported to have caused death in humans or animals.

Lethal Concentration₍₅₀₎ (LC₅₀)-A calculated concentration of a chemical in air to which exposure for a specific length of time is expected to cause death in 50% of a defined experimental animal population.

Lethal Dose_(LO) (LD_{LO})-The lowest dose of a chemical introduced by a route other than inhalation that has been reported to have caused death in humans or animals.

Lethal Dose₍₅₀₎ (LD₅₀)-The dose of a chemical which has been calculated to cause death in 50% of a defined experimental animal population.

Lethal Time₍₅₀₎ (LT₅₀)-A calculated period of time within which a specific concentration of a chemical is expected to cause death in 50% of a defined experimental animal population.

Lowest-Observed-Adverse-Effect Level (LOAEL)-The lowest exposure level of chemical in a study, or group of studies, that produces statistically or biologically significant increases in frequency or severity of adverse effects between the exposed population and its appropriate control.

Lymphoreticular Effects-represent morphological effects involving lymphatic tissues such as the lymph nodes, spleen, and thymus.

Malformations-Permanent structural changes that may adversely affect survival, development, or function.

Minimal Risk Level (MRL) -An estimate of daily human exposure to a hazardous substance that is likely to be without an appreciable risk of adverse noncancer health effects over a specified route and duration of exposure.

Modifying Factor (MF)-A value (greater than zero) that is applied to the derivation of a minimal risk level (MRL) to reflect additional concerns about the database that are not covered by the uncertainty factors. The default value for a MF is 1.

Morbidity-State of being diseased; morbidity rate is the incidence or prevalence of disease in a specific population.

Mortality--Death; mortality rate is a measure of the number of deaths in a population during a specified interval of time.

9. GLOSSARY

Mutagen-A substance that causes mutations. A mutation is a change in the DNA sequence of a cell's DNA. Mutations can lead to birth defects, miscarriages, or cancer.

Necropsy-The gross examination of the organs and tissues of a dead body to determine the cause of death or pathological conditions.

Neurotoxicity-The occurrence of adverse effects on the nervous system following exposure to a chemical.

No-Observed-Adverse-Effect Level (NOAEL)-The dose of a chemical at which there were no statistically or biologically significant increases in frequency or severity of adverse effects seen between the exposed population and its appropriate control. Effects may be produced at this dose, but they are not considered to be adverse.

Octanol-Water Partition Coefficient (K_{ow})-The equilibrium ratio of the concentrations of a chemical in *n*-octanol and water, in dilute solution.

Odds Ratio-A means of measuring the association between an exposure (such as toxic substances and a disease or condition) which represents the best estimate of relative risk (risk as a ratio of the incidence among subjects exposed to a particular risk factor divided by the incidence among subjects who were not exposed to the risk factor). An odds ratio of greater than 1 is considered to indicate greater risk of disease in the exposed group compared to the unexposed.

Organophosphate or Organophosphorus Compound-A phosphorus containing organic compound, especially a pesticide that acts by inhibiting acetylcholinesterase.

Permissible Exposure Limit (PEL)-An Occupational Safety and Health Administration (OSHA) allowable exposure level in workplace air averaged over an 8-hour shift of a 40 hour workweek. Pesticide-General classification of chemicals specifically developed and produced for use in the control of agricultural and public health pests.

Pharmacokinetics-The science of quantitatively predicting the fate (disposition) of an exogenous substance in an organism. Utilizing computational techniques, it provides the means of studying the absorption, distribution, metabolism and excretion of chemicals by the body.

Pharmacokinetic Model-A set of equations that can be used to describe the time course of a parent chemical or metabolite in an animal system. There are two types of pharmacokinetic models: data-based and physiologically-based. A data-based model divides the animal system into a series of compartments which, in general, do not represent real, identifiable anatomic regions of the body whereby the physiologically-based model compartments represent real anatomic regions of the body.

Physiologically Based Pharmacodynamic (PBPD) Model-A type of physiologically-based dose-response model which quantitatively describes the relationship between target tissue dose and toxic end points. These models advance the importance of physiologically based models in that they clearly describe the biological effect (response) produced by the system following exposure to an exogenous substance.

9. GLOSSARY

Physiologically Based Pharmacokinetic (PBPK) Model- is comprised of a series of compartments representing organs or tissue groups with realistic weights and blood flows. These models require a variety of physiological information: tissue volumes, blood flow rates to tissues, cardiac output, alveolar ventilation rates and, possibly membrane permeabilities. The models also utilize biochemical information such as air/blood partition coefficients, and metabolic parameters. PBPK models are also called biologically based tissue dosimetry models.

Prevalence-The number of cases of a disease or condition in a population at one point in time.

Prospective Study-Type of cohort study in which the pertinent observations are made on events occurring after the start of the study. A group is followed over time.

q₁*-The upper-bound estimate of the low-dose slope of the dose-response curve as determined by the multistage procedure. The q₁* can be used to calculate an estimate of carcinogenic potency, the incremental excess cancer risk per unit of exposure (usually µg/L for water, mg/kg/day for food, and µ/m³ for air).

Recommended Exposure Limit (REL)-A National Institute for Occupational Safety and Health (NIOSH) time-weighted average (TWA) concentrations for up to a 10-hour workday during a 40-hour workweek.

Reference Concentration (RfC)-An estimate (with uncertainty spanning perhaps an order of magnitude) of a continuous inhalation exposure to the human population (including sensitive subgroups) that is likely to be without an appreciable risk of deleterious noncancer health effects during a lifetime. The inhalation reference concentration is for continuous inhalation exposures and is appropriately expressed in units of mg/m³ or ppm. The RfC is operationally derived from the No-Observed-Adverse-Effect Level (NOAEL- from animal and human studies) by a consistent application of uncertainty factors that reflect various types of data used to estimate RfCs and an additional modifying factor, which is based on a professional judgment of the entire database on the chemical. The RfCs are not applicable to nonthreshold effects such as cancer.

Reference Dose (RfD)-An estimate (with uncertainty spanning perhaps an order of magnitude) of the daily exposure of the human population to a potential hazard that is likely to be without risk of deleterious effects during a lifetime. The RfD is operationally derived from the No-Observed-Adverse-Effect Level (NOAEL- from animal and human studies) by a consistent application of uncertainty factors that reflect various types of data used to estimate RfDs and an additional modifying factor, which is based on a professional judgment of the entire database on the chemical. The RfDs are not applicable to nonthreshold effects such as cancer.

Reportable Quantity (RQ)-The quantity of a hazardous substance that is considered reportable under the Comprehensive Environmental Response, Compensation, and Liability Act (CERCLA). Reportable quantities are (1) 1 pound or greater or (2) for selected substances, an amount established by regulation either under CERCLA or under Section 311 of the Clean Water Act. Quantities are measured over a 24-hour period.

Reproductive Toxicity-The occurrence of adverse effects on the reproductive system that may result from exposure to a chemical. The toxicity may be directed to the reproductive organs and/or the related endocrine system. The manifestation of such toxicity may be noted as alterations in sexual behavior, fertility, pregnancy outcomes, or modifications in other functions that are dependent on the integrity of this system.

9. GLOSSARY

Retrospective Study-A type of cohort study based on a group of persons known to have been exposed at some time in the past. Data are collected from routinely recorded events, up to the time the study is undertaken. Retrospective studies are limited to casual factors that can be ascertained from existing records and/or examining survivors of the cohort.

Risk-The possibility or chance that some adverse effect will result from a given exposure to a chemical.

Risk Factor-An aspect of personal behavior or lifestyle, an environmental exposure, or an inborn or inherited characteristic, that is associated with an increased occurrence of disease or other health-related event or condition.

Risk Ratio-The ratio of the risk among persons with specific risk factors compared to the risk among persons without risk factors. A risk ratio greater than 1 indicates greater risk of disease in the exposed group compared to the unexposed.

Short-Term Exposure Limit (STEL)-The American Conference of Governmental Industrial Hygienists (ACGIH) maximum concentration to which workers can be exposed for up to 15 min continually. No more than four excursions are allowed per day, and there must be at least 60 min between exposure periods. The daily Threshold Limit Value - Time Weighted Average (TLV-TWA) may not be exceeded.

Target Organ Toxicity-This term covers a broad range of adverse effects on target organs or physiological systems (e.g., renal, cardiovascular) extending from those arising through a single limited exposure to those assumed over a lifetime of exposure to a chemical.

Teratogen-A chemical that causes structural defects that affect the development of an organism.

Threshold Limit Value (TLV)-An American Conference of Governmental Industrial Hygienists (ACGIH) concentration of a substance to which most workers can be exposed without adverse effect. The TLV may be expressed as a Time Weighted Average (TWA), as a Short-Term Exposure Limit (STEL), or as a ceiling limit (CL).

Time-Weighted Average (TWA)-An allowable exposure concentration averaged over a normal 8-hour workday or 40-hour workweek.

Toxic Dose₅₀ (TD₅₀)-A calculated dose of a chemical, introduced by a route other than inhalation, which is expected to cause a specific toxic effect in 50% of a defined experimental animal population.

Toxicokinetic-The study of the absorption, distribution, metabolism, and elimination of toxic compounds in the living organism.

Uncertainty Factor (UF)-A factor used in operationally deriving the Minimal Risk Level (MRL) or Reference Dose (RfD) or Reference Concentration (RfC) from experimental data. UFs are intended to account for (1) the variation in sensitivity among the members of the human population, (2) the uncertainty in extrapolating animal data to the case of human, (3) the uncertainty in extrapolating from data obtained in a study that is of less than lifetime exposure, and (4) the uncertainty in using Lowest-Observed-Adverse-Effect Level (LOAEL) data rather than No-Observed-Adverse-Effect Level (NOAEL) data. A default for each individual UF is 10; if complete certainty in data exists, a value of one can be used; however a reduced UF of three may be used on a case-by-case basis, three being the approximate logarithmic average of 10 and 1.

Xenobiotic- Any chemical that is foreign to the biological system.

APPENDIX A**ATSDR MINIMAL RISK LEVELS AND WORKSHEETS**

The Comprehensive Environmental Response, Compensation, and Liability Act (CERCLA) [42 U.S.C. 9601 et seq.], as amended by the Superfund Amendments and Reauthorization Act (SARA) [Pub. L. 99-4991, requires that the Agency for Toxic Substances and Disease Registry (ATSDR) develop jointly with the U.S. Environmental Protection Agency (EPA), in order of priority, a list of hazardous substances most commonly found at facilities on the CERCLA National Priorities List (NPL); prepare toxicological profiles for each substance included on the priority list of hazardous substances; and assure the initiation of a research program to fill identified data needs associated with the substances.

The toxicological profiles include an examination, summary, and interpretation of available toxicological information and epidemiologic evaluations of a hazardous substance. During the development of toxicological profiles, Minimal Risk Levels (MRLs) are derived when reliable and sufficient data exist to identify the target organ(s) of effect or the most sensitive health effect(s) for a specific duration for a given route of exposure. An MRL is an estimate of the daily human exposure to a hazardous substance that is likely to be without appreciable risk of adverse noncancer health effects over a specified duration of exposure. MRLs are based on noncancer health effects only and are not based on a consideration of cancer effects. These substance-specific estimates, which are intended to serve as screening levels, are used by ATSDR health assessors to identify contaminants and potential health effects that may be of concern at hazardous waste sites. It is important to note that MRLs are not intended to define *clean-up* or action levels.

MRLs are derived for hazardous substances using the no-observed-adverse-effect level/uncertainty factor approach. They are below levels that might cause adverse health effects in the people most sensitive to such chemical-induced effects. MRLs are derived for acute (1-14 days), intermediate (15-364 days), and chronic (365 days and longer) durations and for the oral and inhalation routes of exposure. Currently, MRLs for the dermal route of exposure are not derived because ATSDR has not yet identified a method suitable for this route of exposure. MRLs are generally based on the most sensitive chemical-induced end point considered to be of relevance to humans. Serious health effects (such as irreparable damage to the liver or kidneys, or birth defects) are not used as a basis for establishing MRLs. Exposure to a level above the MRL does not mean that adverse health effects will occur.

APPENDIX A

MRLs are intended only to serve as a screening tool to help public health professionals decide where to look more closely. They may also be viewed as a mechanism to identify those hazardous waste sites that are not expected to cause adverse health effects. Most MRLs contain a degree of uncertainty because of the lack of precise toxicological information on the people who might be most sensitive (e.g., infants, elderly, nutritionally or immunologically compromised) to the effects of hazardous substances. ATSDR uses a conservative (i.e., protective) approach to address this uncertainty consistent with the public health principle of prevention. Although human data are preferred, MRLs often must be based on animal studies because relevant human studies are lacking. In the absence of evidence to the contrary, ATSDR assumes that humans are more sensitive to the effects of hazardous substance than animals and that certain persons may be particularly sensitive. Thus, the resulting MRL may be as much as a hundredfold below levels that have been shown to be nontoxic in laboratory animals.

Proposed MRLs undergo a rigorous review process: Health Effects/MRL Workgroup reviews within the Division of Toxicology, expert panel peer reviews, and agencywide MRL Workgroup reviews, with participation from other federal agencies and comments from the public. They are subject to change as new information becomes available concomitant with updating the toxicological profiles. Thus, MRLs in the most recent toxicological profiles supersede previously published levels. For additional information regarding MRLs, please contact the Division of Toxicology, Agency for Toxic Substances and Disease Registry, 1600 Clifton Road, Mailstop E-29, Atlanta, Georgia 30333.

APPENDIX A

MINIMAL RISK LEVEL (MRL) WORKSHEET

Chemical name: *n*-Hexane
CAS number: 110-54-3
Date: May 19, 1999
Profile status: Draft 3, Post-public comment
Route: Inhalation Oral
Duration: Acute Intermediate Chronic
Key to figure: 69
Species: Human

MRL: 0.6 mg/kg/day ppm mg/m³

Reference: Sanagi S, Seki Y, Sugimoto K, Hirata M. 1980. Peripheral nervous system functions of workers exposed to *n*-hexane at a low level. *Int Arch Occup Environ Health.* 47(1):69-79.

Experimental design: This is an epidemiology study on 2 age-matched groups consisting of 14 control workers and 14 exposed workers employed in a factory producing tungsten carbide alloys. The groups were matched with respect to age, stature, weight, alcohol consumption, and smoking habits. Exposure was estimated with 22 personal samples taken from the breathing zones over a period of 2 years (this number of samples is fewer than optimal for measuring air levels). The 8-hour time-weighted average exposure to solvent vapors consisted of *n*-hexane at 58±41 ppm and acetone at 39±30 ppm; no other solvent vapors were detected. The exposure duration ranged from 1 to 12 years, with an average of 6.2 years. Both groups completed questionnaires and underwent clinical neurological examinations with reference to cranial nerves, motor and sensory systems, reflexes, coordination, and gait. Neurophysiological studies performed included electromyography on muscles of the forearm and leg. Nerve stimulation studies were performed with a surface electrode (motor nerve conduction velocity, residual latency).

Effects noted in study and corresponding doses: In the questionnaire, only the prevalence of headaches, dysesthesia of limbs, and muscle weakness was higher in the exposed group compared to the control. Cranial nerve examinations plus motor and sensory nerve examinations did not reveal any objective abnormal neurological signs. Differences ($p < 0.05$) in the jump test (muscle strength) and the tuning fork test (vibration sensation) were noted. A general trend of diminished muscle strength reflexes was found in the biceps and knees of exposed workers; however, statistically, the difference was not significant. Conduction velocities and distal latencies in the control group were similar to those reported in other studies (Goodgold and Eberstein 1983; Johnson et al. 1983). Control motor nerve conduction velocity for the ulnar and median nerves was 57.3 m/sec ±3.4 in this study compared to 56.9 m/sec ±6.7 for the ulnar nerve in a reference group of 101 males (Johnson et al. 1983). Control motor nerve conduction velocity for the posterior tibial nerve was 48.3 m/sec ±2.3 in this study compared to a reference range of 44.8–51.2 m/sec (Goodgold and Eberstein 1983). No significant differences in electromyograms or nerve conduction velocities in the right median or ulnar nerves were found between the control and exposed groups. However, statistical differences ($p < 0.05$) were detected in the posterior tibial nerve. An increased residual latency of motor conduction and a decreased maximal motor nerve conduction velocity were reported in the exposed workers. Residual latency was 2.21±0.34 m/sec in control versus 2.55±0.48 m/sec in exposed subjects; maximal motor nerve conduction velocity was 48.3±2.1 m/sec in controls versus 46.6±2.3 m/sec in exposed subjects. Normal values for the posterior tibial nerve have been reported as 2.1–5.6 m/sec for distal latency and 44.8–51.2 m/sec for conduction velocity (Goodgold and Eberstein 1983). The subjects in

APPENDIX A

this study were age matched because these parameters vary with increasing age (conduction velocity decreases and distal latency increases). ATSDR considers these differences to be biologically significant.

		<u>Exposed</u>	<u>Control</u>
MMCV	(m/sec)	46.6±2.3*	48.3±2.1
MAP k/a	(%)	90.1±7.4	88.9±11.8
RL	(msec)	2.55±0.48*	2.21±0.34
CVSF	(m/sec)	38.6±2.2	39.1±1.5
dSCV	(m/sec)	42.6±5.0	41.7±3.9
MNCV	(m/sec)	59.1±3.4	60.2±3.3

* significantly different from those of the control group (P<0.05).

CVSF = conduction velocity of slow α = motor fibers; dSCV = distal sensory nerve conduction velocity; MAP k/a = proximal to distal amplitude ratio of muscle action potentials; MMCV = maximal motor nerve conduction velocity; MNCV = mixed nerve conduction velocity; RL = residual latency of motor nerve conduction

Dose end point used for MRL derivation:

NOAEL LOAEL

Uncertainty factors used in MRL derivation:

1 3 10 (for use of a LOAEL)
 1 3 10 (for extrapolation from animals to humans)
 1 3 10 (for human variability)

Was a conversion factor used from ppm in food or water to a mg/body weight dose?

If so, explain: Not applicable.

Was a conversion used from intermittent to continuous exposure? If so, explain: According to Veulemans et al. (1982), steady-state conditions for n-hexane in blood are achieved by 100 minutes of exposure in humans; thus, it is not appropriate to adjust from intermittent to continuous exposure.

$$\begin{aligned} \text{MRL} &= \text{LOAEL} \div \text{UF} \\ &= 58 \text{ ppm} \div 100 \\ &= 0.58 \text{ ppm} \\ &= 0.6 \text{ ppm} \end{aligned}$$

If an inhalation study in animals, list conversion factors used in determining human equivalent dose:

Not applicable.

APPENDIX A

Other additional studies or pertinent information that lend support to this MRL:

It is not clear whether the acetone co-exposure contributed to the neuropathy observed in this study. Indirect evidence from an occupational study (Cardona et al.1996) showed that workplace acetone concentrations had a statistical correlation with the ratio of urinary metabolites to *n*-hexane air concentration, but not with measured urinary metabolites. No animal studies are available describing the effects of inhalation co-exposure to acetone and *n*-hexane, although there are several studies which report interactions between acetone and the neurotoxic metabolite of *n*-hexane 2,5-hexanedione. Oral administration of acetone has been reported to potentiate the neurotoxicity caused by oral exposure to the *n*-hexane metabolite 2,5-hexanedione in rats (Ladefoged et al.1989, 1994). Oral exposure to acetone alone in rats at 650 mg/kg/day resulted in a statistically significant decrease in motor nerve conduction velocity after 6 weeks; co-exposure to acetone and 1,300 mg/kg/day 2,5-hexanedione resulted in greater effects than those seen with 2,5-hexanedione alone (Ladefoged et al.1989). It is possible that acetone may potentiate *n*-hexane neurotoxicity by decreasing body clearance of 2,5-hexanedione (Ladefoged and Perbellini 1986). Simultaneous subcutaneous injection of acetone and 2,5-hexanedione increased the peak concentration of 2,5-hexanedione in rat sciatic nerve compared to injection of 2,5-hexanedione alone (Zhao et al.1998). Acetone also influences the action of many chemicals by its induction of the cytochrome P-450 isozyme CYP2E1 (Patten et al.1986). *n*-Hexane is metabolized by P-450 isozymes; induction by acetone may result in an increased production of the neurotoxic metabolite 2,5-hexanedione. The likelihood of potentiation is small since the equivalent (assuming 100% absorption) of the 650 mg/kg/day acetone used in the Ladefoged study is

$$\frac{650 \text{ mg/kg/day}}{20 \text{ m}^3/\text{day}} \times 70 \text{ kg} \times \frac{24.45}{56.08} = 957 \text{ ppm},$$

which is quite high compared to the 39 ppm in the Sanagi et al. (1980) study.

If the neurotoxicity of *n*-hexane was potentiated in this study by co-exposure to acetone, the level of *n*-hexane alone required to produce these effects would be higher than 58 ppm and the MRL level would be higher. Results from simulations with a PBPK model that accurately predicted *n*-hexane blood and 2,5-hexanedione urine levels (Perbellini et al.1986, 1990a) indicate that at concentrations of 50 ppm, the ratelimiting factor in *n*-hexane metabolism is delivery to the liver, not metabolic activity. This suggests that at this concentration (and at the MRL concentration of 0.6 ppm), induction of P-450 enzymes in the liver by acetone or other chemicals would not affect the rate at which 2,5-hexanedione was produced from *n*-hexane.

n-Hexane is an aliphatic hydrocarbon present in many industrial solvents. It is highly volatile (vapor pressure 150 mm Hg at 25 °C) and practically insoluble in water (9.5 mg/L). Brief exposures in humans to up to 500 ppm are not irritating to the eyes, nose, or throat (Nelson et al.1943). Occupational exposure to *n*-hexane has caused a peripheral neuropathy (both sensory and motor) in humans (Yamamura 1969). The clinical course begins with an insidious numbness in the hands and feet followed by muscle weakness in the extremities. Severe cases result in muscle atrophy and wasting, and sometimes quadriplegia. Removal from exposure results in recovery in affected individuals, the time to recovery depending on the severity of the initial condition. The dose-duration relationship for occupational *n*-hexane neuropathy is not well characterized. Results from a canvass of over 2,000 shoe workers in Japan (93 of whom were diagnosed with neuropathy) indicated that clinical symptoms resulted after exposure for several months for 8-14 hours a day at air concentrations of 500-2,500 ppm (Yamamura 1969). Effects on motor nerve conduction velocities, but no clinical symptoms, have been reported in individuals chronically exposed to 195 ppm (Mutti et al.1982b), 69 ppm (Mutti et al.1982a). In these two studies, exposure to methyl ethyl ketone (which potentiates *n*-hexane in humans and rats [Altenkirch et al.1977, 1982]) also occurred.

APPENDIX A

The critical effect for *n*-hexane is neurotoxicity, and the sensitive species is the rat. The EPA used LOAELs from the same study to establish a Reference Concentration (RfC) of 0.2 mg/m³ (0.06 ppm) for *n*-hexane (IRIS 1996). This was based on a LOAEL of 58 ppm (LOAEL_[HEC] 73 mg/m³) for decreased nerve conduction velocity in humans after occupational exposure for an average of 6.1 years (Sanagi et al. 1980). A supporting study had a LOAEL for respiratory effects of 1,000 ppm (LOAEL_[HEC] 77 mg/m³) in B6C3F₁ mice (Dunnick et al. 1989). Uncertainty factors were 10 to protect unusually sensitive individuals, 10 for use of a LOAEL rather than a NOAEL, and 3 for both the lack of data on reproductive and chronic respiratory effects. EPA also adjusted from an inhalation rate of 10 m³/ 8-hour workday to 20 m³/day and from 5 days/week to 7 days.

Agency Contact (Chemical Manager): Olivia Harris

APPENDIX B

USER'S GUIDE

Chapter 1

Public Health Statement

This chapter of the profile is a health effects summary written in non-technical language. Its intended audience is the general public especially people living in the vicinity of a hazardous waste site or chemical release. If the Public Health Statement were removed from the rest of the document, it would still communicate to the lay public essential information about the chemical.

The major headings in the Public Health Statement are useful to find specific topics of concern. The topics are written in a question and answer format. The answer to each question includes a sentence that will direct the reader to chapters in the profile that will provide more information on the given topic.

Chapter 2

Tables and Figures for Levels of Significant Exposure (LSE)

Tables (2-1, 2-2, and 2-3) and figures (2-1 and 2-2) are used to summarize health effects and illustrate graphically levels of exposure associated with those effects. These levels cover health effects observed at increasing dose concentrations and durations, differences in response by species, minimal risk levels (MRLs) to humans for noncancer end points, and EPA's estimated range associated with an upper-bound individual lifetime cancer risk of 1 in 10,000 to 1 in 10,000,000. Use the LSE tables and figures for a quick review of the health effects and to locate data for a specific exposure scenario. The LSE tables and figures should always be used in conjunction with the text. All entries in these tables and figures represent studies that provide reliable, quantitative estimates of No-Observed-Adverse-Effect Levels (NOAELs), Lowest-Observed-Adverse-Effect Levels (LOAELs), or Cancer Effect Levels (CELs).

The legends presented below demonstrate the application of these tables and figures. Representative examples of LSE Table 2-1 and Figure 2-1 are shown. The numbers in the left column of the legends correspond to the numbers in the example table and figure.

LEGEND

See LSE Table 2-1

- (1) Route of Exposure One of the first considerations when reviewing the toxicity of a substance using these tables and figures should be the relevant and appropriate route of exposure. When sufficient data exists, three LSE tables and two LSE figures are presented in the document. The three LSE tables present data on the three principal routes of exposure, i.e., inhalation, oral, and dermal (LSE Table 2-1, 2-2, and 2-3, respectively). LSE figures are limited to the inhalation (LSE Figure 2-1) and oral (LSE Figure 2-2) routes. Not all substances will have data on each route of exposure and will not therefore have all five of the tables and figures.

APPENDIX B

- (2) Exposure Period Three exposure periods - acute (less than 15 days), intermediate (15-364 days), and chronic (365 days or more) are presented within each relevant route of exposure. In this example, an inhalation study of intermediate exposure duration is reported. For quick reference to health effects occurring from a known length of exposure, locate the applicable exposure period within the LSE table and figure.
- (3) Health Effect The major categories of health effects included in LSE tables and figures are death, systemic, immunological, neurological, developmental, reproductive, and cancer. NOAELs and LOAELs can be reported in the tables and figures for all effects but cancer. Systemic effects are further defined in the "System" column of the LSE table (see key number 18).
- (4) Key to Figure Each key number in the LSE table links study information to one or more data points using the same key number in the corresponding LSE figure. In this example, the study represented by key number 18 has been used to derive a NOAEL and a Less Serious LOAEL (also see the 2 "18r" data points in Figure 2-1).
- (5) Species The test species, whether animal or human, are identified in this column. Section 2.5, Relevance to Public Health, covers the relevance of animal data to human toxicity and Section 2.3, Toxicokinetics, contains any available information on comparative toxicokinetics. Although NOAELs and LOAELs are species specific, the levels are extrapolated to equivalent human doses to derive an MRL.
- (6) Exposure Frequency/Duration The duration of the study and the weekly and daily exposure regimen are provided in this column. This permits comparison of NOAELs and LOAELs from different studies. In this case (key number 1 S), rats were exposed to 1,1,2,2-tetrachloroethane via inhalation for 6 hours per day, 5 days per week, for 3 weeks. For a more complete review of the dosing regimen refer to the appropriate sections of the text or the original reference paper, i.e., Nitschke et al. 1981.
- (7) System This column further defines the systemic effects. These systems include: respiratory, cardiovascular, gastrointestinal, hematological, musculoskeletal, hepatic, renal, and dermal/ocular. "Other" refers to any systemic effect (e.g., a decrease in body weight) not covered in these systems. In the example of key number 18, 1 systemic effect (respiratory) was investigated.
- (8) NOAEL A No-Observed-Adverse-Effect Level (NOAEL) is the highest exposure level at which no harmful effects were seen in the organ system studied. Key number 18 reports a NOAEL of 3 ppm for the respiratory system which was used to derive an intermediate exposure, inhalation MRL of 0.005 ppm (see footnote "b").
- (9) LOAEL A Lowest-Observed-Adverse-Effect Level (LOAEL) is the lowest dose used in the study that caused a harmful health effect. LOAELs have been classified into "Less Serious" and "Serious" effects. These distinctions help readers identify the levels of exposure at which adverse health effects first appear and the gradation of effects with increasing dose. A brief description of the specific endpoint used to quantify the adverse effect accompanies the LOAEL. The respiratory effect reported in key number 18 (hyperplasia) is a Less serious LOAEL of 10 ppm. MRLs are not derived from Serious LOAELs.
- (10) Reference The complete reference citation is given in chapter 8 of the profile.

APPENDIX B

- (11) CEL A Cancer Effect Level (CEL) is the lowest exposure level associated with the onset of carcinogenesis in experimental or epidemiologic studies. CELs are always considered serious effects. The LSE tables and figures do not contain NOAELs for cancer, but the text may report doses not causing measurable cancer increases.
- (12) Footnotes Explanations of abbreviations or reference notes for data in the LSE tables are found in the footnotes. Footnote “b” indicates the NOAEL of 3 ppm in key number 18 was used to derive an MRL of 0.005 ppm.

LEGEND**See Figure 2-1**

LSE figures graphically illustrate the data presented in the corresponding LSE tables. Figures help the reader quickly compare health effects according to exposure concentrations for particular exposure periods.

- (13) Exposure Period The same exposure periods appear as in the LSE table. In this example, health effects observed within the intermediate and chronic exposure periods are illustrated.
- (14) Health Effect These are the categories of health effects for which reliable quantitative data exists. The same health effects appear in the LSE table.
- (15) Levels of Exposure concentrations or doses for each health effect in the LSE tables are graphically displayed in the LSE figures. Exposure concentration or dose is measured on the log scale “y” axis. Inhalation exposure is reported in mg/m³ or ppm and oral exposure is reported in mg/kg/day.
- (16) NOAEL In this example, 18r NOAEL is the critical endpoint for which an intermediate inhalation exposure MRL is based. As you can see from the LSE figure key, the open-circle symbol indicates to a NOAEL for the test species-rat. The key number 18 corresponds to the entry in the LSE table. The dashed descending arrow indicates the extrapolation from the exposure level of 3 ppm (see entry 18 in the Table) to the MRL of 0.005 ppm (see footnote “b” in the LSE table).
- (17) CEL Key number 38r is 1 of 3 studies for which Cancer Effect Levels were derived. The diamond symbol refers to a Cancer Effect Level for the test species-mouse. The number 38 corresponds to the entry in the LSE table.
- (18) Estimated Upper-Bound Human Cancer Risk Levels This is the range associated with the upper-bound for lifetime cancer risk of 1 in 10,000 to 1 in 10,000,000. These risk levels are derived from the EPA’s Human Health Assessment Group’s upper-bound estimates of the slope of the cancer dose response curve at low dose levels (q₁*).
- (19) Key to LSE Figure The Key explains the abbreviations and symbols used in the figure.

SAMPLE

1 →

TABLE 2-1. Levels of Significant Exposure to [Chemical x] – Inhalation

2 →

3 →

4 →

Key to figure ^a	Species	Exposure frequency/ duration	System	NOAEL (ppm)	LOAEL (effect)		Reference
					Less serious (ppm)	Serious (ppm)	
INTERMEDIATE EXPOSURE							
	5	6	7	8	9		10
Systemic	↓	↓	↓	↓	↓		↓
18	Rat	13 wk 5d/wk 6hr/d	Resp	3 ^b	10 (hyperplasia)		Nitschke et al. 1981
<hr style="border-top: 1px dashed black;"/>							
CHRONIC EXPOSURE							
						11	
Cancer						↓	
38	Rat	18 mo 5d/wk 7hr/d				20	(CEL, multiple organs) Wong et al. 1982
39	Rat	89–104 wk 5d/wk 6hr/d				10	(CEL, lung tumors, nasal tumors) NTP 1982
40	Mouse	79–103 wk 5d/wk 6hr/d				10	(CEL, lung tumors, hemangiosarcomas) NTP 1982

12 →

^a The number corresponds to entries in Figure 2-1.

^b Used to derive an intermediate inhalation Minimal Risk Level (MRL) of 5 x 10⁻³ ppm³, dose adjusted for intermittent exposure and divided by an uncertainty factor of 100 (10 for extrapolation from animal to humans, 10 for human variability).

SAMPLE

13 → **Figure 2-1. Levels of Significant Exposure to [Chemical X] – Inhalation**

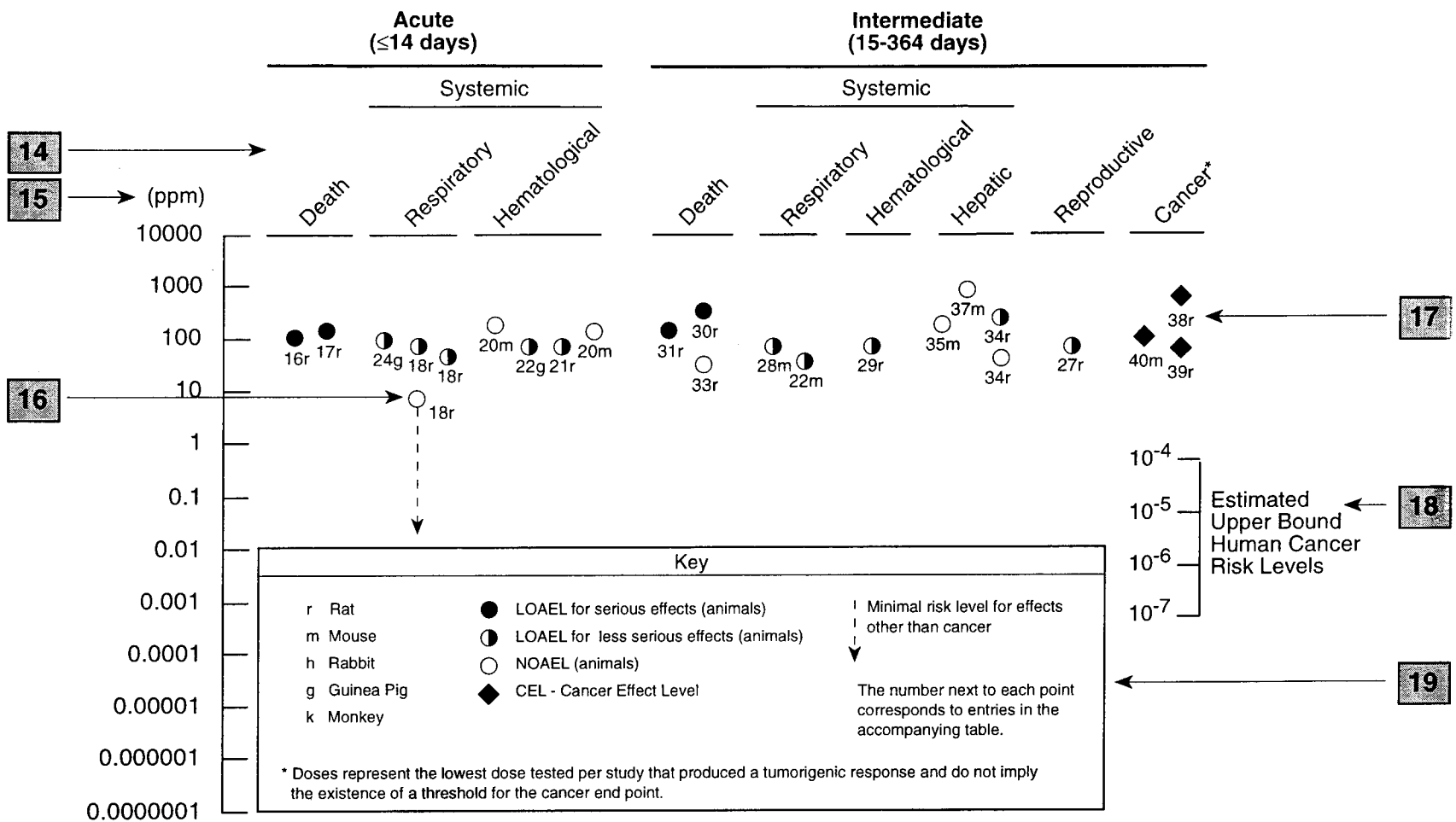

APPENDIX B

Chapter 2 (Section 2.5)**Relevance to Public Health**

The Relevance to Public Health section provides a health effects summary based on evaluations of existing toxicologic, epidemiologic, and toxicokinetic information. This summary is designed to present interpretive, weight-of-evidence discussions for human health end points by addressing the following questions.

1. What effects are known to occur in humans?
2. What effects observed in animals are likely to be of concern to humans?
3. What exposure conditions are likely to be of concern to humans, especially around hazardous waste sites?

The section covers end points in the same order they appear within the Discussion of Health Effects by Route of Exposure section, by route (inhalation, oral, dermal) and within route by effect. Human data are presented first, then animal data. Both are organized by duration (acute, intermediate, chronic). *In vitro* data and data from parenteral routes (intramuscular, intravenous, subcutaneous, etc.) are also considered in this section. If data are located in the scientific literature, a table of genotoxicity information is included.

The carcinogenic potential of the profiled substance is qualitatively evaluated, when appropriate, using existing toxicokinetic, genotoxic, and carcinogenic data. ATSDR does not currently assess cancer potency or perform cancer risk assessments. Minimal risk levels (MRLs) for noncancer end points (if derived) and the end points from which they were derived are indicated and discussed.

Limitations to existing scientific literature that prevent a satisfactory evaluation of the relevance to public health are identified in the Data Needs section.

Interpretation of Minimal Risk Levels

Where sufficient toxicologic information is available, we have derived minimal risk levels (MRLs) for inhalation and oral routes of entry at each duration of exposure (acute, intermediate, and chronic). These MRLs are not meant to support regulatory action; but to acquaint health professionals with exposure levels at which adverse health effects are not expected to occur in humans. They should help physicians and public health officials determine the safety of a community living near a chemical emission, given the concentration of a contaminant in air or the estimated daily dose in water. MRLs are based largely on toxicological studies in animals and on reports of human occupational exposure.

MRL users should be familiar with the toxicologic information on which the number is based. Chapter 2.5, "Relevance to Public Health" contains basic information known about the substance. Other sections such as 2.8, "Interactions with Other Substances," and 2.9, "Populations that are Unusually Susceptible" provide important supplemental information.

MRL users should also understand the MRL derivation methodology. MRLs are derived using a modified version of the risk assessment methodology the Environmental Protection Agency (EPA) provides (Barnes and Dourson 1988) to determine reference doses for lifetime exposure (RfDs).

APPENDIX B

To derive an MRL, ATSDR generally selects the most sensitive endpoint which, in its best judgement, represents the most sensitive human health effect for a given exposure route and duration. ATSDR cannot make this judgement or derive an MRL unless information (quantitative or qualitative) is available for all potential systemic, neurological, and developmental effects. If this information and reliable quantitative data on the chosen endpoint are available, ATSDR derives an MRL using the most sensitive species (when information from multiple species is available) with the highest NOAEL that does not exceed any adverse effect levels. When a NOAEL is not available, a lowest-observed-adverse-effect level (LOAEL) can be used to derive an MRL, and an uncertainty factor (UF) of 10 must be employed. Additional uncertainty factors of 10 must be used both for human variability to protect sensitive subpopulations (people who are most susceptible to the health effects caused by the substance) and for interspecies variability (extrapolation from animals to humans). In deriving an MRL, these individual uncertainty factors are multiplied together. The product is then divided into the inhalation concentration or oral dosage selected from the study. Uncertainty factors used in developing a substance-specific MRL are provided in the footnotes of the LSE Tables.

APPENDIX C**ACRONYMS, ABBREVIATIONS, AND SYMBOLS**

ACGIH	American Conference of Governmental Industrial Hygienists
ADI	Acceptable Daily Intake
ADME	Absorption, Distribution, Metabolism, and Excretion
AFID	alkali flame ionization detector
AFOSH	Air Force Office of Safety and Health
AML	acute myeloid leukemia
AOAC	Association of Official Analytical Chemists
atm	atmosphere
ATSDR	Agency for Toxic Substances and Disease Registry
AWQC	Ambient Water Quality Criteria
BAT	Best Available Technology
BCF	bioconcentration factor
BEI	Biological Exposure Index
BSC	Board of Scientific Counselors
C	Centigrade
CAA	Clean Air Act
CAG	Cancer Assessment Group of the U.S. Environmental Protection Agency
CAS	Chemical Abstract Services
CDC	Centers for Disease Control and Prevention
CEL	Cancer Effect Level
CELDS	Computer-Environmental Legislative Data System
CERCLA	Comprehensive Environmental Response, Compensation, and Liability Act
CFR	Code of Federal Regulations
Ci	curie
CL	ceiling limit value
CLP	Contract Laboratory Program
cm	centimeter
CML	chronic myeloid leukemia
CNS	central nervous system
CPSC	Consumer Products Safety Commission
CWA	Clean Water Act
d	day
Derm	dermal
DHEW	Department of Health, Education, and Welfare
DHHS	Department of Health and Human Services
DNA	deoxyribonucleic acid
DOD	Department of Defense
DOE	Department of Energy
DOL	Department of Labor
DOT	Department of Transportation
DOT/UN/ NA/IMCO	Department of Transportation/United Nations/ North America/International Maritime Dangerous Goods Code
DWEL	Drinking Water Exposure Level

APPENDIX C

ECD	electron capture detection
ECG/EKG	electrocardiogram
EEG	electroencephalogram
EEGL	Emergency Exposure Guidance Level
EPA	Environmental Protection Agency
F	Fahrenheit
F ₁	first-filial generation
FAO	Food and Agricultural Organization of the United Nations
FDA	Food and Drug Administration
FEMA	Federal Emergency Management Agency
FIFRA	Federal Insecticide, Fungicide, and Rodenticide Act
FPD	flame photometric detection
fpm	feet per minute
ft	foot
FR	<i>Federal Register</i>
g	gram
GC	gas chromatography
Gd	gestational day
gen	generation
GLC	gas liquid chromatography
GPC	gel permeation chromatography
HPLC	high-performance liquid chromatography
hr	hour
HRGC	high resolution gas chromatography
HSDB	Hazardous Substance Data Bank
IDLH	Immediately Dangerous to Life and Health
IARC	International Agency for Research on Cancer
ILO	International Labor Organization
in	inch
IRIS	Integrated Risk Information System
K _d	adsorption ratio
kg	kilogram
kkg	metric ton
K _{oc}	organic carbon partition coefficient
K _{ow}	octanol-water partition coefficient
L	liter
LC	liquid chromatography
LC _{Lo}	lethal concentration, low
LC ₅₀	lethal concentration, 50% kill
LD _{Lo}	lethal dose, low
LD ₅₀	lethal dose, 50% kill
LT ₅₀	lethal time, 50% kill
LOAEL	lowest-observed-adverse-effect level
LSE	Levels of Significant Exposure
m	meter
MA	<i>trans,trans</i> -muconic acid
MAL	Maximum Allowable Level
mCi	millicurie

APPENDIX C

MCL	Maximum Contaminant Level
MCLG	Maximum Contaminant Level Goal
MCV	motor nerve conduction velocity
mg	milligram
min	minute
mL	milliliter
mm	millimeter
mm Hg	millimeters of mercury
mmol	millimole
mo	month
mppcf	millions of particles per cubic foot
MRL	Minimal Risk Level
MS	mass spectrometry
NAAQS	National Ambient Air Quality Standard
NAS	National Academy of Science
NATICH	National Air Toxics Information Clearinghouse
NATO	North Atlantic Treaty Organization
NCE	normochromatic erythrocytes
NCI	National Cancer Institute
NIEHS	National Institute of Environmental Health Sciences
NIOSH	National Institute for Occupational Safety and Health
NIOSHTIC	NIOSH's Computerized Information Retrieval System
NFPA	National Fire Protection Association
ng	nanogram
NLM	National Library of Medicine
nm	nanometer
NHANES	National Health and Nutrition Examination Survey
nmol	nanomole
NOAEL	no-observed-adverse-effect level
NOES	National Occupational Exposure Survey
NOHS	National Occupational Hazard Survey
NPD	nitrogen phosphorus detection
NPDES	National Pollutant Discharge Elimination System
NPL	National Priorities List
NR	not reported
NRC	National Research Council
NS	not specified
NSPS	New Source Performance Standards
NTIS	National Technical Information Service
NTP	National Toxicology Program
ODW	Office of Drinking Water, EPA
OERR	Office of Emergency and Remedial Response, EPA
OHM/TADS	Oil and Hazardous Materials/Technical Assistance Data System
OPP	Office of Pesticide Programs, EPA
OPPTS	Office of Prevention, Pesticides and Toxic Substances, EPA
OPPT	Office of Pollution Prevention and Toxics, EPA
OSHA	Occupational Safety and Health Administration
OSW	Office of Solid Waste, EPA

APPENDIX C

OTS	Office of Toxic Substances
OW	Office of Water
OWRS	Office of Water Regulations and Standards, EPA
PAH	Polycyclic Aromatic Hydrocarbon
PBPD	Physiologically Based Pharmacodynamic
PBPK	Physiologically Based Pharmacokinetic
PCE	polychromatic erythrocytes
PEL	permissible exposure limit
PID	photo ionization detector
pg	picogram
pmol	picomole
PHS	Public Health Service
PMR	proportionate mortality ratio
ppb	parts per billion
ppm	parts per million
ppt	parts per trillion
PSNS	Pretreatment Standards for New Sources
REL	recommended exposure level/limit
RfC	Reference Concentration
RfD	Reference Dose
RNA	ribonucleic acid
RTECS	Registry of Toxic Effects of Chemical Substances
RQ	Reportable Quantity
SARA	Superfund Amendments and Reauthorization Act
SCE	sister chromatid exchange
sec	second
SIC	Standard Industrial Classification
SIM	selected ion monitoring
SMCL	Secondary Maximum Contaminant Level
SMR	standard mortality ratio
SNARL	Suggested No Adverse Response Level
SPEGL	Short-Term Public Emergency Guidance Level
STEL	short-term exposure limit
STORET	Storage and Retrieval
TD ₅₀	toxic dose, 50% specific toxic effect
TLV	threshold limit value
TOC	Total Organic Compound
TPQ	Threshold Planning Quantity
TRI	Toxics Release Inventory
TSCA	Toxic Substances Control Act
TRI	Toxics Release Inventory
TWA	time-weighted average
U.S.	United States
UF	uncertainty factor
VOC	Volatile Organic Compound
yr	year
WHO	World Health Organization
wk	week

APPENDIX C

>	greater than
\geq	greater than or equal to
=	equal to
<	less than
\leq	less than or equal to
%	percent
α	alpha
β	beta
γ	gamma
δ	delta
μm	micrometer
μg	microgram
q_1^*	cancer slope factor
-	negative
+	positive
(+)	weakly positive result
(-)	weakly negative result