

Preprint 15-090

A NEW HIGH FORCE AND DISPLACEMENT SHOTCRETE TEST

L. Martin, Office of Mine Safety and Health Research, Spokane, WA
C. Clark, Office of Mine Safety and Health Research, Spokane, WA
J. Johnson, Office of Mine Safety and Health Research, Spokane, WA
M. Stepan, Office of Mine Safety and Health Research, Spokane, WA

ABSTRACT

Shotcrete and mesh are often installed to control ground deformation, falls and ejection between bolts. The combination of mesh and shotcrete forms a panel or plate that is typically bent by ground extruding between restraining rockbolts. The ground pressure applied (that is, the resistance of these panels to bending) over large ground deformations is important for maintaining ground support safety. This paper describes a new test device that measures this resistance and its evolution over large deformations. Mixes of shotcrete, mesh and other components that can maintain significant support pressure are desired, a characteristic described as the “toughness” of support. Results show toughness depends largely on how shotcrete is integrated with other components. Shotcrete strength is less important.

INTRODUCTION

Ground control safety often depends on supporting, or at least containing, the ground between the rockbolts. Shotcrete and mesh, in various combinations and with other components, are often called upon to do this (Figure 1). Applications are especially common in mines with squeezing ground or seismic loading. The support pressure maintained during ground deformation is key to the performance of these systems, and to protecting miner safety. However, the toughness of a design is difficult to estimate. Researchers at the Office of Mine Safety and Health Research (OMSHR) responded to this deficiency or “gap” by designing a full scale test device, described in this paper, and beginning a testing program. Some initial results from this program are reported to demonstrate test capabilities.

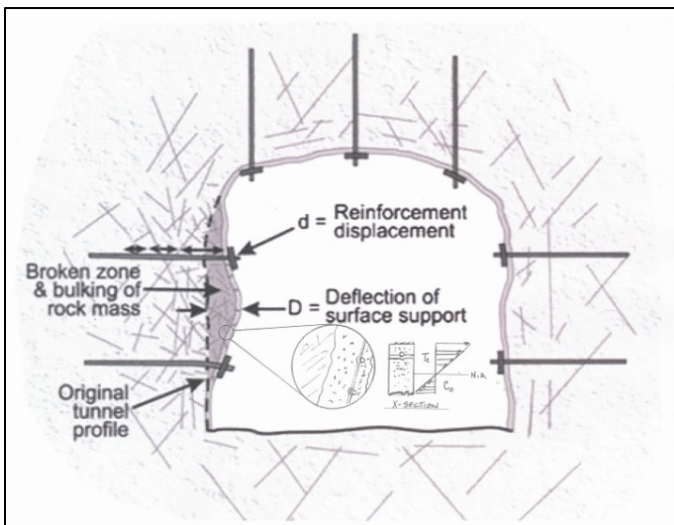

Figure 1. Diagram of the reinforced shotcrete system, after Kaiser and Cai [2012].

BACKGROUND - TOUGHNESS

Mining in ground that fails from the combination of in situ and mining induced stress is commonplace. Ground support elements are installed to reinforce such ground and preserve mine safety. Typically, the strength of support is considered key, and is used to prevent or halt yielding.

However, ground movements driven by creep of weak ground or seismic loading may be impossible to halt altogether. In these cases, it is essential that support is able to yield with the ground in a safe manner while maintaining confining pressure that mobilizes the strength of rock in the immediate perimeter of the opening. In addition, it's usually desirable to contain ground between rockbolts to protect miners from loose rock that might fall or be ejected.

Shotcrete and screen are often employed, sometimes together and in combination with other support elements, to accomplish this function. A key characteristic of such a system is its ability to maintain support pressure through large ground deformations, a characteristic often called “toughness” – especially in support systems incorporating shotcrete. Toughness can be quantified as the work done during deformation (e.g. force x displacement).

BACKGROUND – TOUGHNESS TESTING

Previous research projects at NIOSH's OMSHR Spokane Research Laboratory have addressed shotcrete applied to the perimeter or surface of an underground opening. Quality control was an emphasis in this work, especially attaining sufficient early strength to assure safe re-entry. This work also included methods for determining strength at first crack, flexural strength, toughness, and shotcrete-rock adhesion strength [Martin et al. in press; Martin et al. 2010; Clark et al. 2011; Seymour et al. 2010]. However, testing was not sufficiently comprehensive to determine total system toughness.

To date, the most comprehensive testing of total system toughness used a test frame described by Kirsten [1992 and 1993]. Kirsten's test rig was designed for full-scale testing of 4.8- ft square reinforced shotcrete samples anchored by bolts installed on a 3-ft square pattern (Figure 2).

Tannant and Kaiser [1997] reported using this device to explore relationships between toughness and sample thickness. Samples were displaced with either a pressurized bag with an area of 8-ft² or a hand-powered jack with a 4-in square bearing plate. Both were limited to 6-in of deflection at the center of the panel. They found results did not vary significantly with loading method. Tests focused on the performance of 2 to 6-in thick fiber and mesh reinforced shotcrete panels.

This test method provided a valuable starting point for this work. Alterations in test capability were found to be desirable. Most significantly, the test “stroke” or maximum displacement fell far short of displacement magnitudes observed in situ. For example, rockbursts in deep metal mines, contained by shotcrete, mesh and bolts have been observed to exert deformations of up to 3 feet as noted by Ortlepp and Stacey [1998], Stacey et al. [1995]. Large deformations have also been observed in yielding ground in Nevada (Figure 3) despite heavy

use of shotcrete and mesh. As such, a test device was needed to measure high resistance energies (toughness) over high displacements. A combination dubbed High-Energy High-Displacement (HEHD).

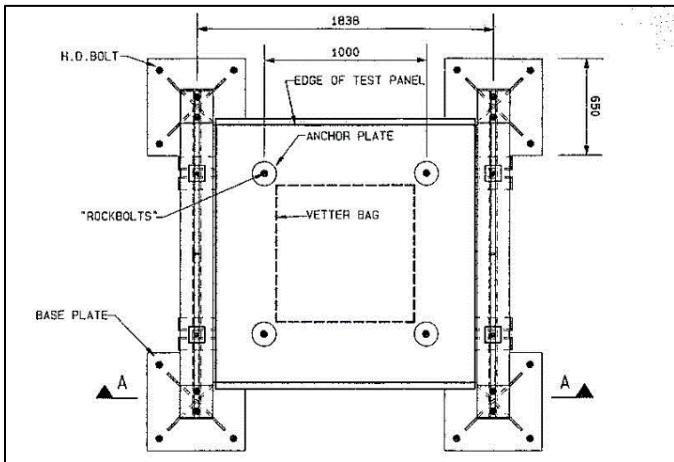

Figure 2. Plan view of panel testing frame, after Kirsten [1993].



Figure 3. Ground failure in a high yielding underground mine.

Thus, HEHD test frame specifications were modified from Kirsten's design for the current test program. First, a stroke of 10-in was specified, roughly doubling test stroke. Second, the scale of testing was expanded somewhat to accommodate a 4-ft bolt pattern while minimizing edge effects. Finally, better information on deformation volume changes and crack geometry was desired for comparison with field observations. A spherical load platen geometry was specified that avoided edge effects inherent in a loading plate and that is more durable than a pressurized bag. This was not expected to have a significant impact, as Tannant and Kirsten had found that loading geometry has a minimal effect on results. Adhesion of shotcrete to ground is ignored, as it was by Tannant and Kirsten.

HEHD TEST

The HEHD test frame is comprised of four reinforced concrete columns situated upon and through-bolted to a structural test floor. Centered on the floor between the columns is a 150-ton, 12-inch stroke extensible ram fitted with a spherically shaped head (Figure 4).

The spherically shaped head is pushed through the test panel while being restrained by D-bolts embedded in the four columns of the test frame (Figure 5). Rockbolt plates, bolt resin and other details match typical in-mine use.

Load and displacement data are collected during the test using an advanced data acquisition system (Figure 6). Tests are monitored by a pair of calibrated cameras. Test geometry is derived from images using photogrammetric methods.

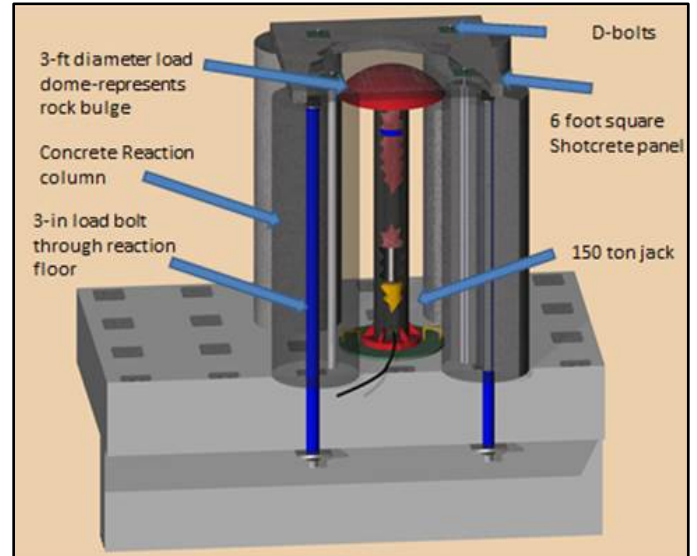

Figure 4. High-Energy, High-Displacement (HEHD) test machine design.

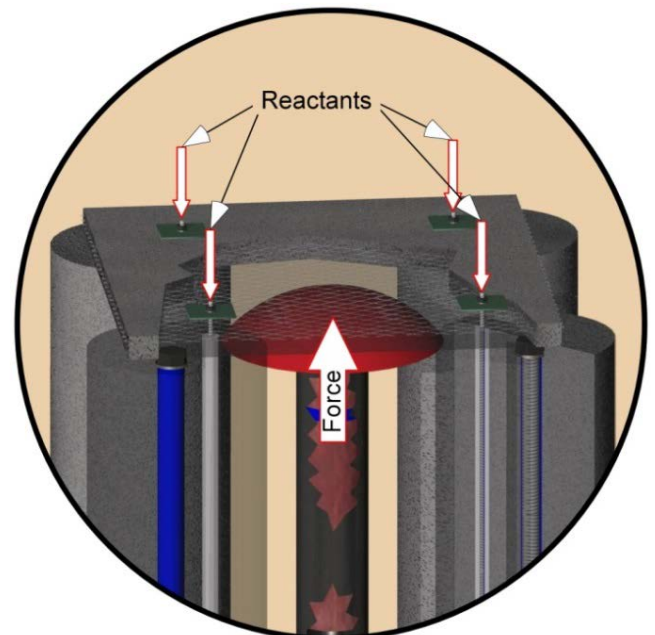

Figure 5. Diagram of the force during the high-energy displacement panel test and tester.

TEST PROCEDURE

For each HEHD test, a shotcrete panel was positioned and anchored atop the cement support columns (Figure 7). The loading ram was then raised to a position just below the test panel (Figure 8). Operation of the various diagnostic systems was then checked (e.g. data acquisition, photogrammetry, photography and video). Finally, the hydraulic ram was energized and pushed through a 10 inch displacement at a fixed displacement rate (Figure 9). The ram was then retracted.

TEST OBSERVATIONS

As the ram drives through the test panel, the panel ruptures in a repeatable pattern. First is the formation of 4 cracks bisecting each panel side and meeting at panel center, dividing the panel into quadrants (Figure 10). Next to form are 4 cracks that bisect the approximate midpoint of each of the previously mentioned segments

and form the base of 4 Isosceles triangles that converge at the center of the panel (Figure 11).

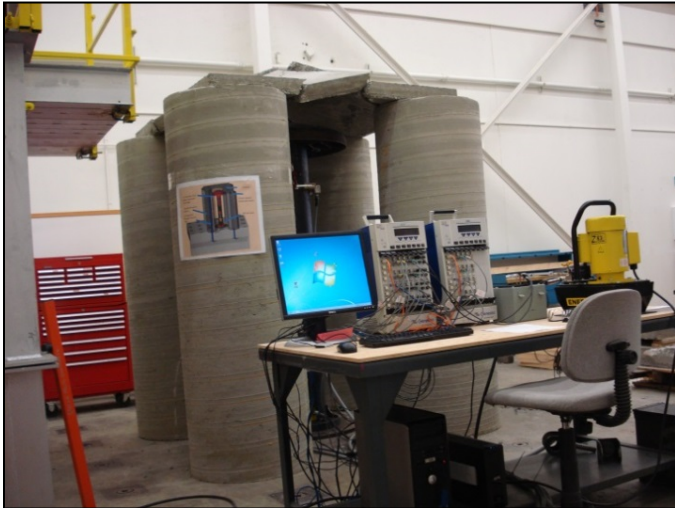

Figure 6. High-Energy, High-Displacement (HEHD test machine) in operation.

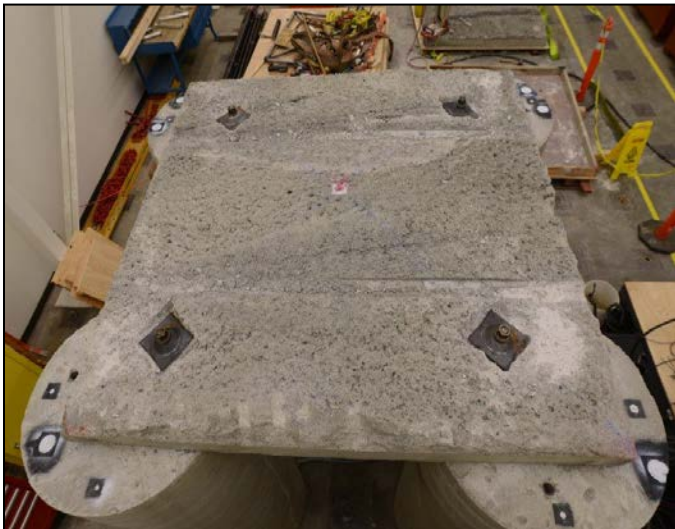

Figure 7. HEHD panel with in-mine roof bolt pattern.



Figure 8. HEHD panel with loading head in position for test to start.



Figure 9. HEHD panel test sample loaded to 10-in displacement (side view).

Another set of 4 cracks form that split the Isosceles triangles into right triangles and 4 hinge cracks develop simultaneously, adjacent to the rock bolt panel anchor points (Figure 12). At the conclusion of the test, the panel is left with orderly sets of cracks along hinge lines spaced about 60° (Figure 13). The center portion of the panel has ruptured and distorted into the shape of the spherical loading head.



Figure 10. HEHD panel test sample initial loading to 0 to 2-in displacement (oblique and side view).

Cracking exposes the shotcrete matrix and wire mesh reinforcement, showing how these components work together to maintain toughness (Figure 14).

TYPICAL RESULTS

Tests are characterized by a load-versus-displacement plot (Figure 15) that shows the essential features of a test. The initial peak occurs as the panel suffers its first crack. There is some variability of when this happens, probably due to variations in reinforcement

placement, cement content of the shotcrete mix and panel thickness. Peak strength develops as the cracked panel deforms further and fully mobilizes reinforcement strength.

displacement profile. Figure 17 presents an energy-versus-displacement profile. The toughness (work done) of the panel is derived from the aggregate area under the load versus displacement curve.



Figure 11. HEHD panel test sample initial loading to 2 to 6-in displacement (oblique and side view).



Figure 12. HEHD panel test sample initial loading to 6 to 8-in displacement (oblique and side view).

Of particular interest is the significant residual strength (post-first-crack) over the test displacement of 10 inches. Figure 16 presents energy visually as the solid green area under the load-versus-

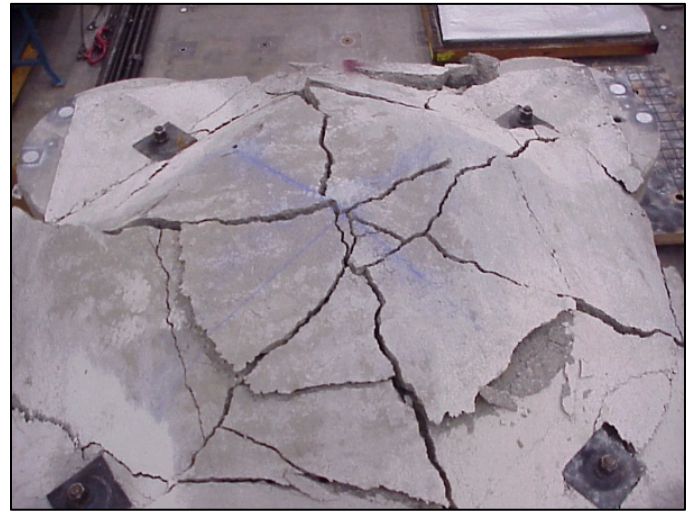

Figure 13. HEHD panel test sample initial loading to 8 to 10-in displacement (oblique, plan and side view).



Figure 14. HEHD panel test sample with exposed wire mesh.

INITIAL TESTS

An initial set of “shakedown” tests was devised to prove and refine test design. Two distinctly different panel types were tested. The main differences were shotcrete placement method and reinforcement type. The first three panels (numbered 1, 2, and 3) were mine shotcrete mix that was sprayed in-situ with woven wire (cyclone) fence type wire reinforcement. The other two panels (numbered 4 and 5) were mine shotcrete mix that was cast in forms with 4 x 4-in spaced ¼-in diameter welded wire mesh reinforcement. Mesh was located in lower 1/3rd of these 4-in high test panels.

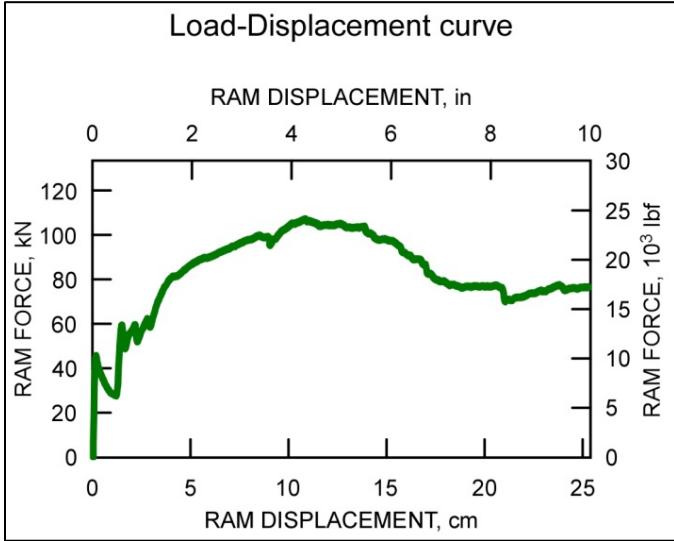

Figure 15. HEHD panel test load versus displacement curve.

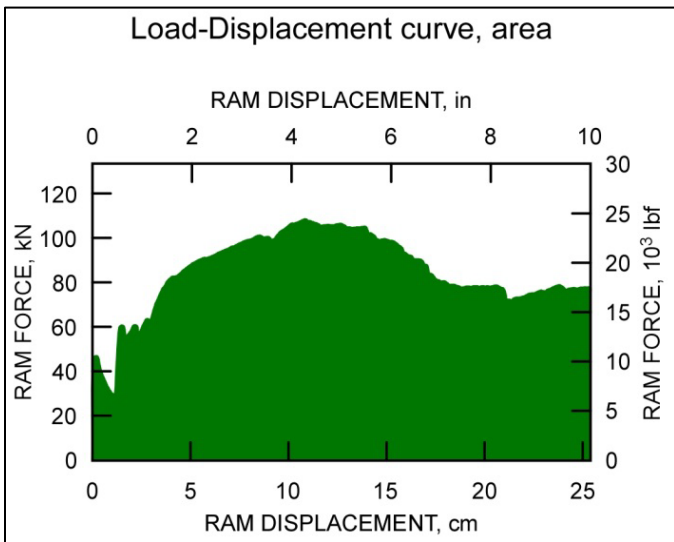

Figure 16. Load-displacement curve from HEHD test area under the curve is the energy or toughness.

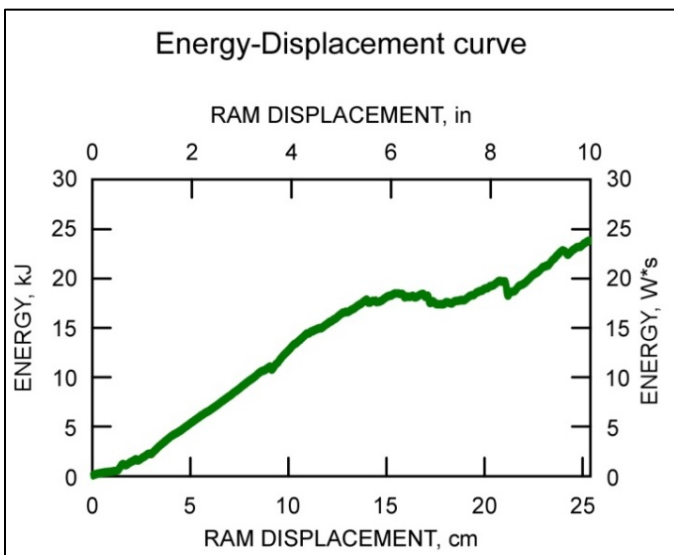

Figure 17. Energy versus displacement curve from HEHD test.

Panels, 1, 2 and 3 were extremely overshoot (out of specification with respect to thickness—in some areas of the panels up to 2.5 times too thick). Shotcrete (4-in ± ¼-in specified panel thickness was actually 12-in thick in some areas). This produced a high value for first crack that was non-typical for this size of panel. This anomaly with regard to thickness had little impact after first crack as represented by the graphs for panels numbered 1, 2 and 3. As shown in Figure 18, the overshoot panel is mapped using photogrammetry methods. The volumes of the post-cracked panels are also calculated by these methods for later comparison to energy calculations [Benton et al. 2014].

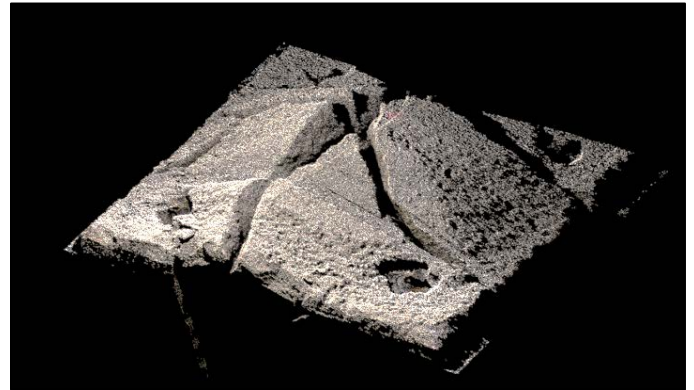

Figure 18. Photogrammetry developed photo of test panel.

Figure 19 shows the composite load versus displacement graphs for the 5 panel tests conducted. The post first-crack load capacity looks similar in all tests up to approximately 2-in of displacement. The load capacity over the 2 to 6-in displacement shows the superiority of welded wire mesh in panels 4 and 5 over that of the woven mesh reinforcement in panels 1, 2, 3. From 6 to 8-in of displacement, the high fall-off of the load capacity of the welded wire mesh may be due to the wire mesh de-bonding and pulling out rather than yielding or breaking. In the 8 to 10-in range, all tests panels show similar behavior.

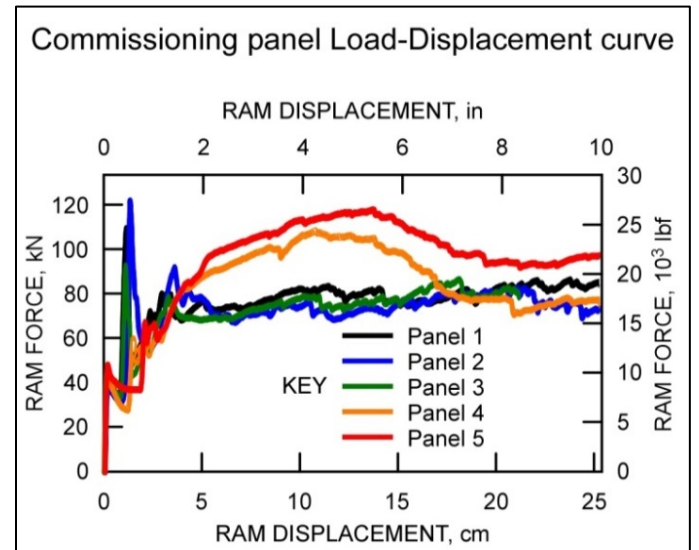

Figure 19. Load-displacement curves from HEHD panel tests.

Results are plotted as cumulative energy in Figure 20. During the middle of the tests, from 2 to 6 inches of ram displacement, wire mesh is tougher than woven wire mesh (cyclone fence) by up to 5 W*s over the entire ram displacement energy graph segment. Resistance plateaus after 8 inches of displacement but persists through the full test stroke, showing all samples achieved the essential objective of this support design.

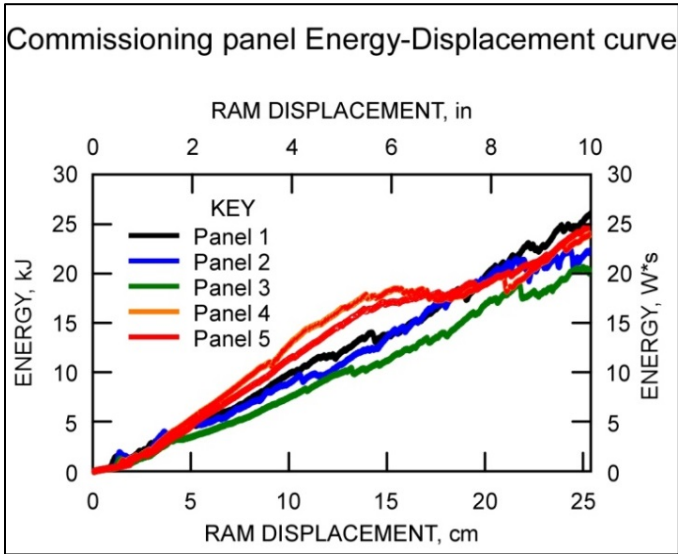

Figure 20. Energy versus displacement curve from HEHD panel tests.

FURTHER TESTS

A further set of tests was conducted after commissioning of the HEHD test machine to define toughness of a mine support design currently in use, and of three alternative support designs. Collaborating mine personnel provided specifications for their existing shotcrete and wire mesh design, including a 5,000 psi shotcrete mix and woven wire mesh (cyclone fence). Alternative designs used 11-lb of EPC® BarChip⁵⁴ polyfiber fibers per yard of shotcrete. These designs included (1) replacing mesh with fibers added to the shotcrete (2) adding fibers to shotcrete and retaining the mesh and (3) retaining mesh and applying shotcrete in two layers with fibers added only to the second (the interior layer, or tensile layer during bending).

Panels were hand-shot to specification¹ by a certified nozzle person at NIOSH's Reardan facility near Spokane. Panels 6, 7 and 8 were plain shotcrete sprayed over woven wire mesh. 9, 10 and 11 were shotcrete reinforced with polyfiber. Only 9 and 11 were tested as panel 10 cracked during shipment. 12, 13 and 14 were built with a 2-in layer of shotcrete over woven wire mesh followed by a 2-in layer of polyfiber reinforced shotcrete. Finally, 15, 16 and 17 were polyfiber shotcrete applied over woven wire mesh.

As shown in Figure 21, the load-displacement graphs for the panels indicate that all designs with woven wire mesh reinforcement provided more resistance after 5 inches of displacement than the polyfiber-only design, whose resistance decreased after first crack. However, polyfiber panels did achieve a higher first crack strength.

Test results are re-plotted to show toughness (work versus displacement) in Figure 22. Clearly, woven wire mesh reinforced panels perform better by this measure. Polyfibers added to the panels, either fully or through one half of panel thickness, provided only incremental benefit despite raising the first-crack strength. Fiber-only panels lose most of their toughness after 6 inches of displacement. Combining fiber and mesh and fiber reinforcement provided the best performance. That is, high initial "first-crack" strength followed by high, consistent toughness through at least 10 inches of displacement.

Samples of shotcrete were collected and tested from all panels to check for possible variations in shotcrete quality (Tables 1 and 2).

¹ The use of experienced and competent shotcrete machine operators who have been adequately task-trained in the application of shotcrete is essential to ensure the quality of the shotcrete application. In simplest terms, this means the shotcrete operator can successfully apply shotcrete to the work surface to a uniform and consistent depth and with an absence of voids and lenses.

Uniaxial compressive tests and splitting tensile tests were conducted. The shotcrete specification called for 5000 psi compressive strength at 28 days, and was exceeded on all test samples. Fiber reinforced samples were nominally stronger, consistent with their higher first-crack strengths, in both tension and compression. Average tensile strengths were 10 to 12% of compressive strength, regardless of the presence of fiber. The data also show that sprayed samples do provide a higher tensile strength as would be expected, due to the material being applied pneumatically and compacted dynamically under high velocity.

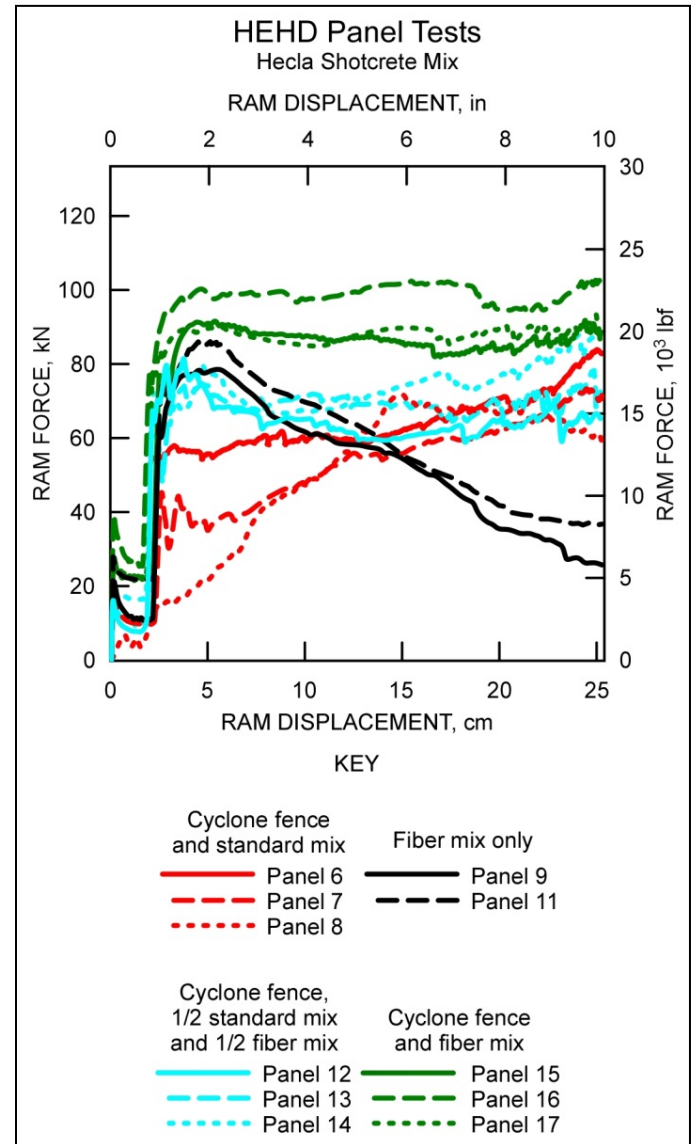

Figure 21. Load-displacement curve for mine specified sprayed panels.

DISCUSSION

The main factors that affect load capacity and toughness of the panel support system are mix design and reinforcement type respectively. In the case of mix design, the amount of Portland cement has a direct bearing on the load capacity and first crack load. In the case of wire reinforcement both the position and the wire gauge of the wire mesh are influential, as it is the wire that carries the load 'post-first-crack,' that is, once the shotcrete has cracked. For fiber reinforcement, fiber type and density are influential, as the fibers carry the load 'post-first-crack.'

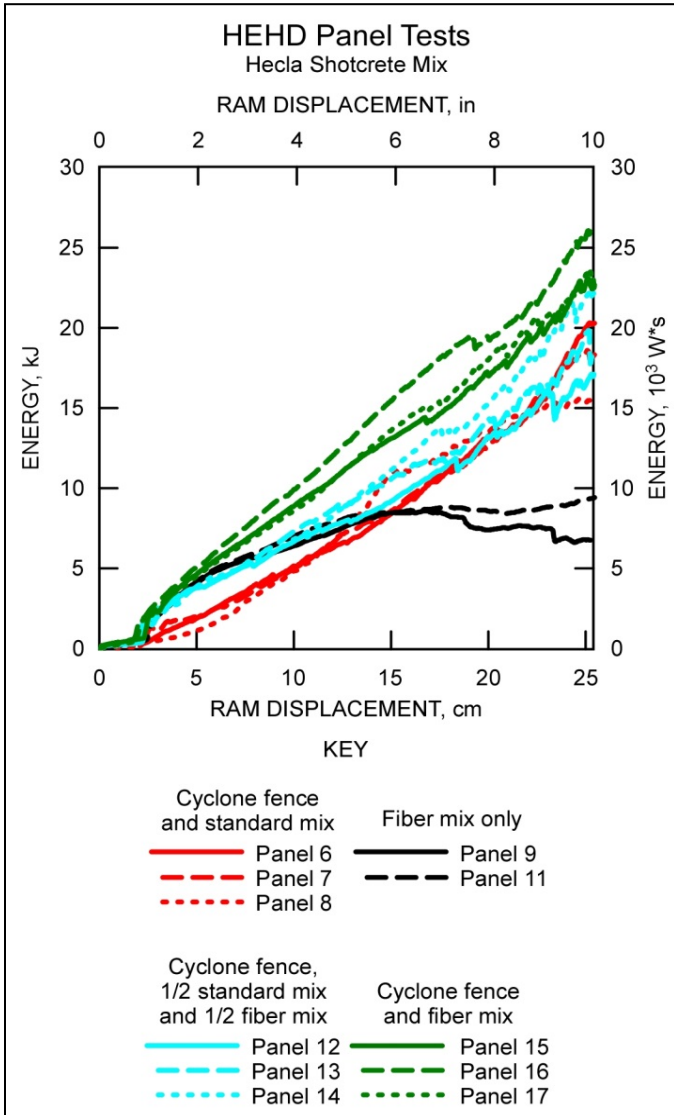

Figure 22. Energy-displacement curve for mine specified sprayed panels.

Table 1. Unconfined compression test results from cylinders.

Unconfined Compression Strengths		
sample type	date	strength (psi)
cast	4/15	7275
cast	4/30	7079
sprayed w fiber	4/30	7011
cast	5/7	6970
cast w fiber	5/7	8079
sprayed w fiber	5/7	6344
cast w fiber	5/21	7271
sprayed w fiber	5/21	8332

Table 2. Splitting tensile tests results from cylinders.

Splitting Tensile Strengths		
Sample type	date	strength (psi)
cast	4/15	908
cast	4/30	913
sprayed w fiber	4/30	1140
cast	5/7	942
cast w fiber	5/7	1161
cast w fiber	5/21	1012
sprayed w fiber	5/21	1366

Panel toughness is primarily determined by reinforcement. For wire mesh, wire-spacing and gauge determine the total wire cross-sectional area that can contribute to panel toughness. Toughness will be reduced if the installed embedment depth is not correct and/or the wire condition is poor. In the case of fiber reinforcement, the type, density, and dispersion of fibers within the matrix will influence toughness. The embedment depth, condition of the wire mesh and fiber density (if used), are evident in a visual inspection of cross-section taken from panel sections after tests. Location of wire mesh below the neutral axis of bending (i.e. where tension is greatest) will enhance both strength and toughness [Stacey et al. 1995].

Quality control in applying shotcrete support is essential. Toughness, in particular, depends on the shotcrete adhering well to the reinforcement and the reinforcement being well encapsulated by the shotcrete within the matrix. Additionally, the shotcrete must be applied to the specified thickness [Papworth 2002]. A number of field portable methods of testing shotcrete and shotcrete support system quality have been developed [Martin et al. in press].

CONCLUSIONS

A High-Energy High-Displacement (HEHD) test machine has been developed to measure the toughness of reinforced shotcrete designs used for ground support. This machine allows for testing support system designs over a greater displacement while using a larger sample sizes than previous efforts. All tests are conducted at full scale (10-inch displacement stroke and 6 x 6-ft square panel).

Preliminary results show the HEHD test can readily define the strength and toughness characteristics of various support designs, providing information important for matching designs with ground support requirements. Two important design features were demonstrated in these tests. First, reinforcement specifications were found to largely control support toughness. For example, replacing the woven wire mesh with welded wire mesh during HEHD shakedown tests increased panel toughness by approximately 25% in the 4 to 6-inch displacement range. Second, increases in "first-crack" strength did not correlate with toughness or maximum resistance.

A limited parametric test was conducted using woven wire mesh and fiber reinforcement of the shotcrete mix in various combinations. Optimal results were obtained for mine panels with a combination of polyfibers at a dosage of 11-lb/yd³ and woven wire mesh (cyclone fencing). These are only a few of many possible designs, some of which are the subject of ongoing tests.

ACKNOWLEDGEMENTS

The authors would like to thank all of the following persons and companies for their contributions. Without them, the project would have not been able to provide these test results. Mark Board of Hecla Mining Company for his invaluable insight of ground control system building in seismic prone ground and parameters on the HEHD test. In addition, Patrick Lewandowski of elasto plastic concrete for supplying the BarChip⁵⁴ fibers for the shotcrete panels and Mike Johnson of Ragged Ridge Construction for all his shotcrete nozzling work. Jess McDonald for his concrete placement and specialty form work.

REFERENCES

- Benton, D., Iverson, S., Martin, L. & Johnson, J. 2014. Calibration and Application of Photogrammetric monitoring of rock mass behavior in deep vein mining. 33rd International Conference on Ground Control in Mining. Morgantown, WV.
- Clark, C.C., M.A. Stepan, J.B. Seymour, and L.A. Martin 2011. Early Strength Performance of Modern Weak Rock Mass Shotcrete Mixes. *Mining Engineering*, Vol. 63, No.1, Jan. 2011, Society for Mining, Metallurgy, and Exploration, pp. 54-59.
- Kaiser, PK, Cai, M 2012. Design of rock support system under rockburst conditions. *Journal of Rock Mechanics and Geotechnical Engineering*, 4(3); 215-227.

- Kirsten, H 1993. Equivalence of mesh and fibre reinforced shotcrete at large deflections. *Can. Geotech. J.*, Vol.30, 418-440. Ottawa, Canada National Research Council.
- Kirsten, H 1992. Comparative efficiency and ultimate strength of mesh and fibre-reinforced shotcrete as determined from full scale bending tests. *J.S. Afr. Inst. Min. Metall.*, Vol.92, No.11/12, Nov/Dec. 303-323.
- Martin, L.A, C.C. Clark, J.B. Seymour, and M.A. Stepan, in press. Shotcrete Design and Installation Compliance Testing: Early Strength, Load Capacity / Toughness, Adhesion Strength, and Applied Quality RI 9XXX, In-press.
- Martin, L.A, B. Seymour, C. Clark, M. Stepan, R. Pakalnis, M. Roworth, and C. Caceres 2010. An Analysis of Flexural Strength and Crack Width for Fiber-Reinforced Shotcrete Used in Weak Rock Mass Mines. 2010 Transactions of the Society of Mining, Metallurgy, and Engineering, Vol. 328, pp. 542-549.
- Ortlepp, W.D. and Stacey, T.D. 1998. Performance of Tunnel Support under Large Deformation Static and Dynamic Loading. *Tunnelling/Tunneling and Underground Space Technology*, Vol. 13, No. 1, pp. 15-21.
- Papworth, F. 2002. Design Guidelines for use of Fiber Reinforced Shotcrete in Ground Support, American Shotcrete Association, Shotcrete Magazine, spring 2002, pp.16-21.
- Seymour J.B., L.A. Martin, C.C. Clark, M.A. Stepan, R. Jacksha, R. Pakalnis, M. Roworth, and C. Caceres 2010. A shotcrete adhesion test system for mining applications. 2010 Transactions of the Society of Mining, Metallurgy, and Engineering, Vol. 328, pp. 533-541.
- Stacey, T.R., Ortlepp W.D. and Kirsten, H.A.D.1995. Energy-absorption capacity of reinforced shotcrete, with reference to the containment of rockburst damage. *The Journal of The South African Institute of Mining and Metallurgy*. MAY/JUNE. pp. 137-140.
- Tannant, D and Kaiser, PK 1997. Evaluation of shotcrete and mesh behaviour under large imposed deformations. International symposium on rock support – Applied solutions for underground structures/structures. Lillehammer Norway. Broch, E Myrvang, A stjern, G (ed.), June 22-25. 782-792.