

Hemoglobinopathies:

Current Practices for Screening,
Confirmation and Follow-up

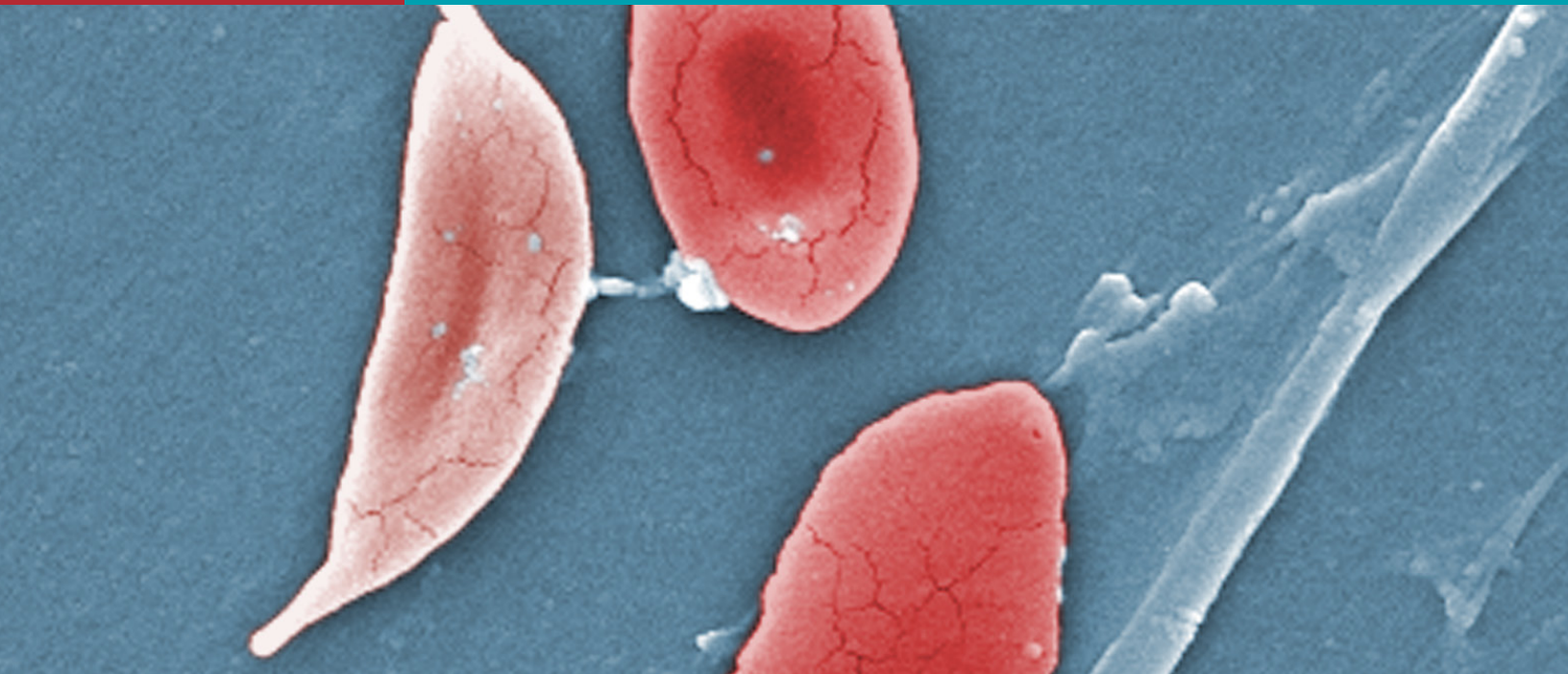

DECEMBER 2015

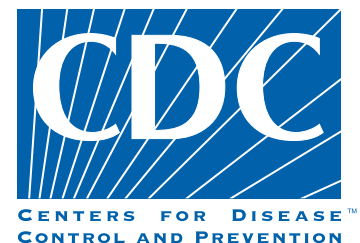

Cover photo: This digitally-colored scanning electron micrograph (SEM) revealed some of the comparative ultrastructural morphology between normal red blood cells (RBCs), and a sickle cell RBC (left) found in a blood specimen of an 18 year old female patient with sickle cell anemia, (HbSS). Credit: CDC/ Sickle Cell Foundation of Georgia: Jackie George, Beverly Sinclair (photographer: Janice Haney Carr)

The mark “CDC” is owned by the US Dept. of Health and Human Services and is used with permission. Use of this logo is not an endorsement by HHS or CDC of any particular product, service, or enterprise.

This publication was supported by Cooperative Agreement # U60HM000803 funded by the Centers for Disease Control and Prevention. Its contents are solely the responsibility of the authors and do not necessarily represent the official views of CDC or the Department of Health and Human Services.

National Center for Immunization and Respiratory Diseases (IP)

Office of Surveillance, Epidemiology and Laboratory Services (OSELS)

National Center for HIV, Viral Hepatitis, STDs and TB Prevention (PS)

National Center for Zoonotic, Vector-borne, and Enteric Diseases (CK)

National Center for Environmental Health (NCEH)

Coordinating Office for Terrorism Preparedness and Emergency Response (CTPER)

© Copyright 2015, Association of Public Health Laboratories. All Rights Reserved.

Table of Contents

I. Executive Summary	3
II. Acknowledgements	4
III. Introduction to Hemoglobinopathies	5
IV. History of Hemoglobinopathy Screening	6
VI. Methodologies for Hemoglobinopathy Screening and Diagnosis	10
Isoelectric focusing (IEF)	10
High Performance Liquid Chromatography (HPLC)	11
Cellulose Acetate Electrophoresis (Alkaline)	12
Citrate Agar Electrophoresis (Acid)	13
Alkaline Globin Chain Electrophoresis.....	13
Capillary Zone Electrophoresis	13
Molecular Methods.....	15
VII. Method Advantages, Limitations and Testing Strategy	18
VIII. Algorithms for Hemoglobinopathy Detection	22
Unknown Hemoglobin Variants.....	22
IX. Quality Assurance for Hemoglobinopathy Screening and Testing	26
Pre-analytical Phase.....	26
Analytical Phase.....	26
Post-analytical Phase.....	27

X. Follow-up	28
Follow-up for Hemoglobinopathies	28
XI. References	31
XII. Appendices	34
Appendix A: Examples of Molecular Methods for Hb Mutation Detection.....	34
Appendix B: Top 20 Hemoglobinopathies in Four States.....	37
Appendix C: State 1 DNA Screening Algorithm.....	39
Appendix D: Hemoglobinopathy Screening Algorithm for State 1.....	40
Appendix E: Hemoglobinopathy Screening Algorithm for State 1 – Older Children & Adults.....	41
Appendix F: State 1 Hemoglobinopathy Result Codes.....	42
Appendix G: State 2 Hemoglobin Coding System.....	46
Appendix H: State 3 Hb Reporting Algorithm.....	50
Appendix I: State 4 Hb Screening Algorithm.....	51
Appendix J: State 4 Hb Result Codes.....	52

I. Executive Summary

The hemoglobinopathies are a group of disorders passed down through families (inherited) in which there is abnormal production or structure of the hemoglobin molecule. Sickle cell disease (SCD) is one such blood disorder caused by the abnormal hemoglobin that damages and deforms red blood cells. The abnormal red cells break down, causing anemia, and obstruct blood vessels, leading to recurrent episodes of severe pain and multi-organ ischemic damage. SCD affects millions of people throughout the world and is particularly common among people whose ancestors come from sub-Saharan Africa, regions in the Western Hemisphere (South America, the Caribbean, and Central America); Saudi Arabia; India; and Mediterranean countries such as Turkey, Greece and Italy. There is no widely available cure for SCD although some children have been successfully treated with blood stem cell, or bone marrow, transplants.¹ However, hematopoietic stem cell transplant is not widely done for SCD, because of the difficulty in finding a matched donor. Therefore, the number of people with SCD who get transplants is low. In addition, there are several complications associated with the procedure, including death in about 5 percent of people. In SCD, clinical severity varies, ranging from mild and sometimes asymptomatic states to severe symptoms requiring hospitalization. Symptomatic treatments exist, and newborn screening (NBS) for SCD can reduce the burden of the disease on affected newborns and children.

Thalassemia is another type of blood disorder that is caused by a defect in the gene that helps control the production of the globin chains that make up the hemoglobin molecule.² There are two main types of thalassemia:

- Alpha thalassemia occurs when a gene or genes related to the alpha globin protein are missing or changed (mutated). Alpha thalassemias occur most often in persons from Southeast Asia, the Middle East, China and in those of African descent.
- Beta thalassemia occurs when a beta globin gene is changed (mutated) so as to affect production of the beta globin protein.
- Beta thalassemias occur most often in persons of Mediterranean origin. To a lesser extent, Chinese, other Asians and African Americans can be affected.

In 2013, the National Center on Birth Defects and Developmental Disabilities, Division of Blood Disorders (DBD), Centers for Disease Control and Prevention (CDC) in collaboration with the Association of Public Health Laboratories (APHL) Newborn Screening and Genetics in Public Health Program convened an APHL Hemoglobinopathy Laboratory Workgroup to address issues around hemoglobinopathy laboratory testing. The workgroup objectives are as follows:

- Discuss the issues related to building and enhancing US laboratory capacity in the areas of screening and diagnosis of hemoglobinopathies.
- Conduct an inventory of state and regional labs that are currently performing (or have the capacity to develop) sickle cell disease laboratory testing.
- Develop a training program for implementing laboratory technology in state public health laboratories, universities, and community centers for testing.
- Consult with CDC and other partners to evaluate current laboratory methodologies and make recommendations for improvements.
- Identify and document best practices that have been used in SCD public health laboratory training; identify training standards and competency outcomes.

One of the products of the APHL Hemoglobinopathy Laboratory Workgroup is this guidance document on hemoglobinopathy laboratory testing and follow-up techniques. This document explores current screening and diagnostic methods available that are currently employed by some screening and diagnostic laboratories. It also includes an overview of laboratory structure discussing algorithms for testing, reporting and follow-up from several programs in the US. Furthermore, this document aims to improve and strengthen US and international capabilities by offering best practices thereby contributing to the goal of early detection of hemoglobin disorders.

II. Acknowledgements

The Association of Public Health Laboratories gratefully acknowledges the contributions of the APHL Hemoglobinopathy Laboratory Workgroup, experts and partners at the Newborn Screening and Molecular Biology Branch, National Center for Environmental Health and the Division of Blood Disorders, National Center on Birth Defects and Developmental Disabilities.

Maria del Pilar Aguinaga, PhD, MT (ASCP), MB (ASCP), DLM (ASCP)
Sickle Cell Center, Meharry Medical College

Ming Chan, PhD
Florida Department of Health

Tim Clark Davis, BS
Washington State Newborn Screening Laboratory

M. Christine Dorley, MSP, BS MT(ASCP)
Tennessee Department of Health/Laboratory Services

Bonifacio Dy, MD
Nevada State Public Health Laboratory

Marie Earley, PhD
Centers for Disease Control and Prevention

Althea M. Grant, PhD
Centers for Disease Control and Prevention

Mary Hulihan, MPH
Centers for Disease Control and Prevention

Suzanne Karabin, MS, CGC
New Jersey Department of Health

Joanne Mei, PhD
Centers for Disease Control and Prevention

Christine Moore, MT (ASCP)
Texas Department of State Health Services

Laxmi Nayak, MS
New Jersey Department of Health

Kwaku Ohene-Frempong, MD
The Children's Hospital of Philadelphia

III. Introduction to Hemoglobinopathies

Hemoglobin is a tetramer composed of two α -globin and two non- α -globin chains working in conjunction with heme to transport oxygen in the blood.^{2,3} Normal adult hemoglobin (HbA) is designated $\alpha_2\beta_2$.^{2,3} Variant hemoglobin is derived from gene abnormalities affecting the α -globin genes (HBA1 or HBA2) or β -globin (HBB) structural genes (exons).^{2,3,4} More than a thousand hemoglobin variants have been identified relative to changes in the globin chains.³ Qualitative changes correspond to amino acid substitutions resulting in hemoglobinopathies. Quantitative changes like amino acid insertions, deletions or mutations in the intervening sequences (introns) correspond to thalassemia and result in decreased globin chain production.^{2,3,4}

Alpha thalassemias are caused by changes (deletions, point mutations, insertions, etc.) in the α -globin genes. Production of α -globin is controlled by the four alleles of HBA1 and HBA2. In the deletional type α -thalassemias, the number of α -globin gene deletions correlates to disease severity.⁴ One α -globin gene deletion is unremarkable (also called silent carrier) whereas a two α -globin gene deletion (α -thalassemia trait) and three α -globin gene deletion (HbH disease) have varied clinical and hematological features. A four α -globin gene deletion (Hb Bart's Hydrops fetalis) is severe and not typically compatible with life.^{2,4}

Beta globin variants more commonly seen include HbS, HbC, HbD, HbE and HbG. A mutation in one β -globin subunit results in a combination of variant and normal hemoglobin and denotes carrier or trait status, also known as the heterozygote state. Mutations in both β -globin subunits result in disease based on a homozygous or heterozygous expression. In the case of sickle cell anemia (HbSS), mutations are homozygous with production of HbS.² Other diseases classed under sickle cell disease (SCD), for example HbSE, HbSC and HbS β -thalassemia are heterozygous expressions. Regardless of an α -globin or β -globin variant, severity of disease can range from insignificant to serious or life threatening.^{2,3,4,5} Therefore, early detection through newborn screening is paramount.^{6,7}

Hemoglobinopathies, specifically HbSS, HbS/ β -thalassemia and HbSC disease were added to the Recommended Uniform Screening Panel (RUSP) in 2006. The Maternal and Child Health Bureau of the Health Resources and Services Administration (HRSA) of the United States (US) in conjunction with the American College of Medical Genetics (ACMG) determined these disorders to be clinically significant and included them as core targets easily detected by newborn screening. These were added based on the severity of illness associated with sickle cell disorders.⁷ Symptoms range from anemia to severe pain and vaso-occlusive crises eventually affecting multiple organ systems with chronic deterioration over time.⁶ Early detection of SCD reduces the risk of invasive *Streptococcus pneumoniae* (pneumococcus) infection through penicillin prophylaxis. In addition, early diagnosis of SCD prior to onset of symptoms or complications, allows health workers to educate the family about SCD and offer anticipatory guidance, in the context of comprehensive care of the child. Additional hemoglobinopathies readily detected by newborn screening were also added as secondary targets.⁶ Examples include HbE disease, HbC disease, HbSE disease, etc.

Methods for newborn screening and diagnosis differ across laboratory programs. Some methods detect multiple variants whereas others detect only the most common. While some methods are automated, others are manual and labor intensive. Diagnostic methods include DNA based applications with some procedures requiring sophisticated instrumentation.

Programs are also structured differently. Some laboratories are screen-only labs whereas others screen and perform diagnostic testing. Some use a second tier assay to confirm an abnormal result prior to patient referral for diagnosis. In addition, reporting and follow-up algorithms differ between programs. Based on these differences a comprehensive review of methodologies and program structures are warranted.

IV. History of Hemoglobinopathy Screening

Prior to 1960s, Sickle cell disease (SCD) was diagnosed mainly through hematological studies and clinical manifestations. In the late sixties, only a few states screened some newborns for sickle cell disease, among a handful of genetic disorders. In 1971, in response to pressure by African American advocacy groups, the US government made sickle cell disease a scientific and health care priority by allocating funds for treatment and research. Several Sickle Cell Centers were created in the country, mainly associated with universities or medical centers, including some at medical schools of Historically Black College and Universities.⁸ In 1973, a survey of annual workloads of US state public health laboratories known as The Consolidated Annual Report (CAR) showed that 12 state public health laboratories had some form of sickle cell screening program. (Table 3-5, Consolidated Annual Report, 1973).⁹ On May 16, 1972, under President Nixon, the US Congress signed into law the National Sickle Cell Disease – Sickle Cell Anemia Control Act (Public Law 92-294).⁸ In 1975, the first universal newborn screening (NBS) program for SCD was implemented in New York on a pilot basis.¹⁰ Subsequently, screening was adopted by the remaining states throughout the late 1980s and 1990s and into the 2000s. Initially, screening was targeted for populations at risk, primarily African Americans. However, the missed cases rate was higher than 30% due to difficulty in identifying an infant's race or ethnicity at birth and so universal screening was implemented.¹¹ Later on, other hemoglobinopathies were acknowledged as important public health issues.

Since infection from capsulated organisms caused high mortality and morbidity in children with SCD, penicillin prophylaxis was introduced in 1986 for infants with SCD.¹² Penicillin prophylaxis significantly reduced infection-related mortality and became a powerful incentive to implement widespread neonatal screening for SCD.^{12,13,14,15}

Since May 1, 2006, all 50 states and the District of Columbia require and provide universal newborn screening (NBS) for SCD and other hemoglobinopathies even though national recommendation was made over a quarter of century ago (1987).^{9,12} NBS is well recognized as the largest and most successful health promotion and disease prevention system in the United States. NBS is the practice of testing every newborn for certain harmful or potentially fatal conditions that are not otherwise apparent at birth. A sample is collected before the newborn leaves the hospital and identifies serious, life-threatening conditions before symptoms begin. Although such conditions are usually rare, they can affect a newborn's normal physical and mental development. Early detection is crucial in NBS since intervention can prevent death or a lifetime of severe disabilities.

Along with the initial newborn screening goal to identify SCD, other hemoglobin disorders such as, beta (β) and alpha (α) thalassemia have gained significant attention in recent years due to the rapidly changing demographics in the US as a result of increased immigration. Hence, hemoglobin disorders common in other countries are being seen more frequently in the US.¹⁶

As it pertains to screening techniques, laboratories originally used citrate agar electrophoresis for screening of abnormal hemoglobins in cord blood. The subsequent improvement in the hemoglobinopathy electrophoretic techniques, made it possible to screen newborns by using either cord blood or heel stick samples (dried blood spots).

Currently, the majority of hemoglobinopathy screening programs use a combination of isoelectric focusing (IEF) and high performance liquid chromatography (HPLC) as primary screening methods (Table 1). Many programs use second complimentary electrophoretic technique, HPLC, immunologic tests or DNA-based assays to confirm specimens with abnormal screening results.¹³ See Table 1 for a distribution of laboratories versus methods utilized. Most of the current screening methodologies are sensitive and specific in detecting high risk infants; however, each method has its own unique limitations.

Table 1: Number of Newborn Screening Quality Assurance Program Proficiency Testing Participants Using Multi-Level Schemes to Enhance the Specificity of Screening for Hemoglobinopathies (2014)

Method	Isoelectric Focusing	Bio-Rad HPLC	Extended Gradient HPLC	Trinity Biotech (Primus) Ultra2 HPLC	Electrophoresis Citrate Agar	Electrophoresis Alkaline Cellulose	Monoclonal Antibody Methods	DNA Amplification
Level 1	33	41	2	0	0	0	1	0
Level 2	19	13	5	5	1	1	0	1
Level 3	2	2	1	0	2	0	0	0
Level 4	1	0	0	0	0	0	0	0

Screening programs using any of the screening methods must maintain high-quality results to ensure accurate interpretation of the phenotypes for immediate initiation of supportive care for infants affected with hemoglobinopathies.

V. Types of Specimens for Hemoglobinopathy Screening and Diagnosis

At one time, programs in the US required cord blood for hemoglobinopathy screening; however programs now use dried blood spots (DBS). DBS are collected from a heel prick and spotted onto filter paper.¹⁷ For additional information on newborn screening specimen collection refer to Clinical and Laboratory Standards Institute (CLSI) document NBS01-A6, Blood Collection on Filter Paper for Newborn Screening Programs.¹⁸ Newborn screening specimens should be properly collected to avoid clotting, smearing, inadequately filled circles, oversaturation or scratching by capillary tube. Although these specimens may be unsatisfactory for some newborn screening tests, they may be acceptable for hemoglobinopathy testing (see NBS01-A6 for details).

DBS and liquid whole blood are used for screening and/or confirmation of children (greater than one year of age) and adults. There are changes in hemoglobin types and quantities through the first year of life, but after a year of age the hemoglobin types of an individual are going to remain the same. See Figure 1 and Table 2 for changes in relative proportions of globin chains at various stages of embryonic, fetal and post-natal life.¹⁹ Table 2 lists the percentages of normal and variant hemoglobin seen in newborns and older children.

Figure 1: Globin switch during in utero and post-natal life

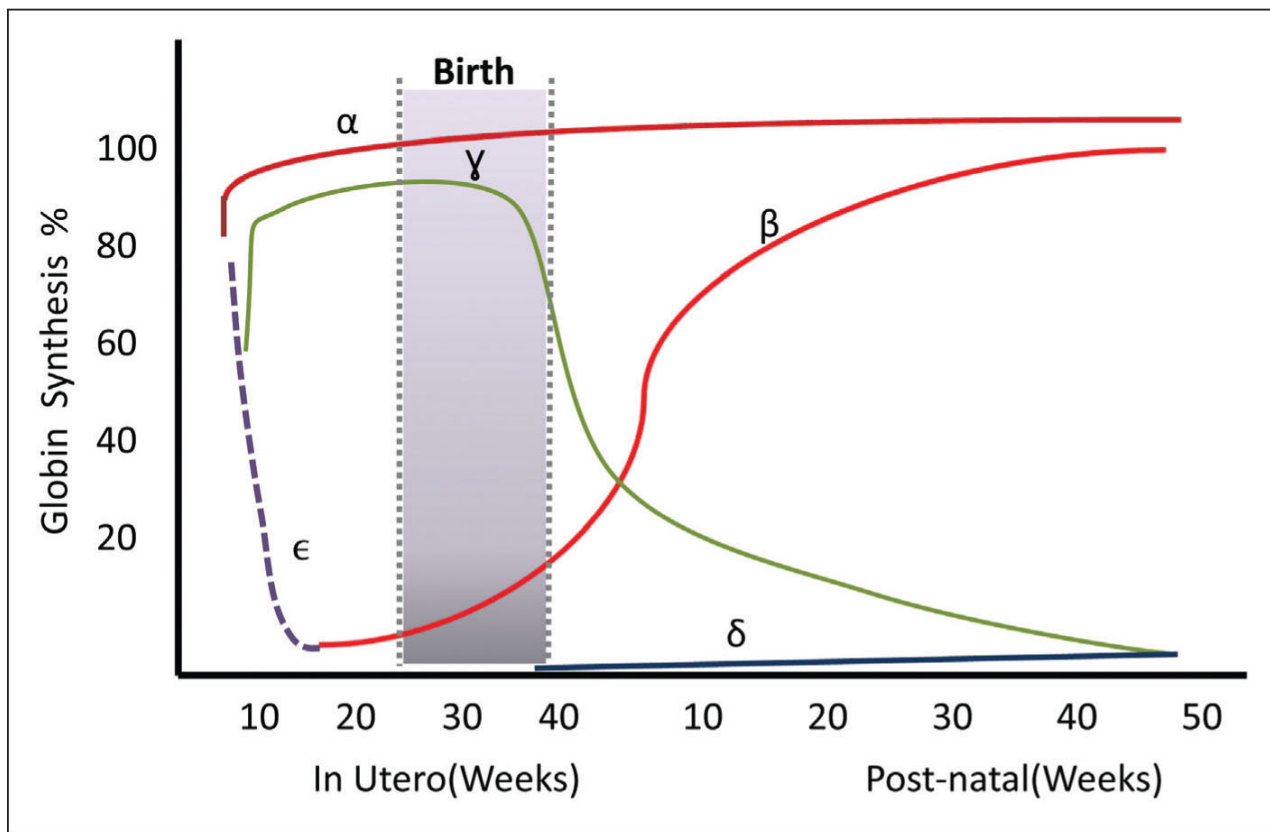

* Figure courtesy of Deepak Kamat, MD, PhD, FAAP via Healio.com

Table 2: Normal and Variant Hemoglobin at Birth and in Older Children

Hemoglobin	Structure	Levels at Birth	Levels in Adults	Comments
A	$\alpha_2\beta_2$	20%-25%	97%	Reaches adult levels by 1 year of age
A ₂	$\alpha_2\delta_2$	0.5%	2.5%	Elevated in β thalassemia trait
F	$\alpha_2\gamma_2$	75%-80%	< 1%	Reaches adult levels by 1 year of age
HbH	β_4	15%-20% in HbH disease	NA	HbH produces Heinz bodies in the erythrocytes and hemolysis
Hb Bart	γ_4	100% in hydrops fetalis, 15%-25% in HbH disease	NA	Increased in carriers of α thalassemia trait at birth

NA = not applicable.

* Figure courtesy of Deepak Kamat, MD, PhD, FAAP via Healio.com

For the collection of whole blood samples, Ethylene Diamine Tetra Acetic Acid (EDTA) is the typical anti-coagulant used. Heparin may interfere with DNA amplification by Polymerase Chain Reaction (PCR). For DBS collected from a finger stick, the palmar surface of the finger's last phalanx is most frequently used, see CLSI document GP42-A6 for additional information.²⁰ High heat and humidity can change the levels of hemoglobin A and S in DBS samples.²¹ To maintain the integrity of hemoglobin molecules, high humidity and temperature should be minimized during transport and storage.

Blood smears should not be used for hemoglobinopathy screening. A smear is unreliable as it requires the presence of sickled cells which may or may not be in circulation at the time of collection. Blood smears also cannot differentiate homozygous from heterozygous nor can they detect other hemoglobin variants.²²

Transfusion may affect hemoglobinopathy screening results. The transfused blood can mask a hemoglobinopathy, or the transfused blood may contain a hemoglobin variant that does not belong to the patient. In cases of transfusion, hemoglobinopathy screening should be repeated four months post transfusion according to the Clinical and Laboratory Standards Institute (CLSI)²³ or according to individual program guidelines.

There are several different methods as next described that are used for hemoglobinopathy screening and confirmation. Specific specimen requirements may vary between these methods.

VI. Methodologies for Hemoglobinopathy Screening and Diagnosis

Various methods for hemoglobinopathy newborn screening and adult testing are employed by US laboratories. Many programs traditionally used electrophoresis as the method of choice for identification and quantification of aberrant hemoglobins.²⁴ In more recent years, with the introduction of universal screening of newborns, technology has emerged that is robust with high throughput and greater sensitivity over electrophoresis.^{24,25} Many of the same methods used for screening, such as Isoelectric focusing (IEF) and High performance liquid chromatography (HPLC) are also used for diagnosis. Some laboratories employ one or more methods in their protocol for detection of hemoglobinopathies. Choice of method depends on the function of the laboratory and its testing algorithm. Molecular methods are emerging and are being utilized by some screening and diagnostic labs alike to obtain a more comprehensive analysis and determine the nature of the hemoglobinopathy and its clinical implications. Below are descriptions of methods used. Descriptions include traditional methods requiring a hands-on approach, more current procedures requiring automation and lastly, molecular assays.

Isoelectric focusing (IEF)

IEF separates proteins in a gel medium that has a pH gradient consisting of ampholytes (zwitterions). When a high voltage is applied, narrow buffered zones are created with stable, but slightly different pHs (Figure 2). Slower moving proteins migrate through these zones and stop at their individual isoelectric points (pI).³ In the case of hemoglobin, these migrate to a zone in the medium where the pH of the gel matches the hemoglobin's pI. At the pI, the charge of the hemoglobin becomes zero and ceases to migrate. The hemoglobin migration order of IEF is similar to alkaline electrophoresis. Resolution is clear with differentiation of HbC from HbE and HbO and HbS from HbD and HbG respectively. HbA and HbF are also clearly differentiated.²⁴ With neonatal specimens, a distinct band representing acetylated HbF is readily identified and slightly anodic to HbA.²⁶ Staining may be necessary depending on the manufacturer's recommendations. Gels may be read wet or dry and band identification is accomplished by comparison to migration patterns of known quality controls.²⁶ This method allows for greater precision and accurate quantification than standard electrophoresis. It gives excellent resolution in addition to high throughput, but is also labor-intensive and time consuming.^{3,24,26} An alternative method is needed to confirm or differentiate hemoglobin variants (bands other than HbF or HbA).²⁶ Fast migrating bands (Hb Bart's, HbH) can also be identified by IEF.

Figure 2: Isoelectric Focusing

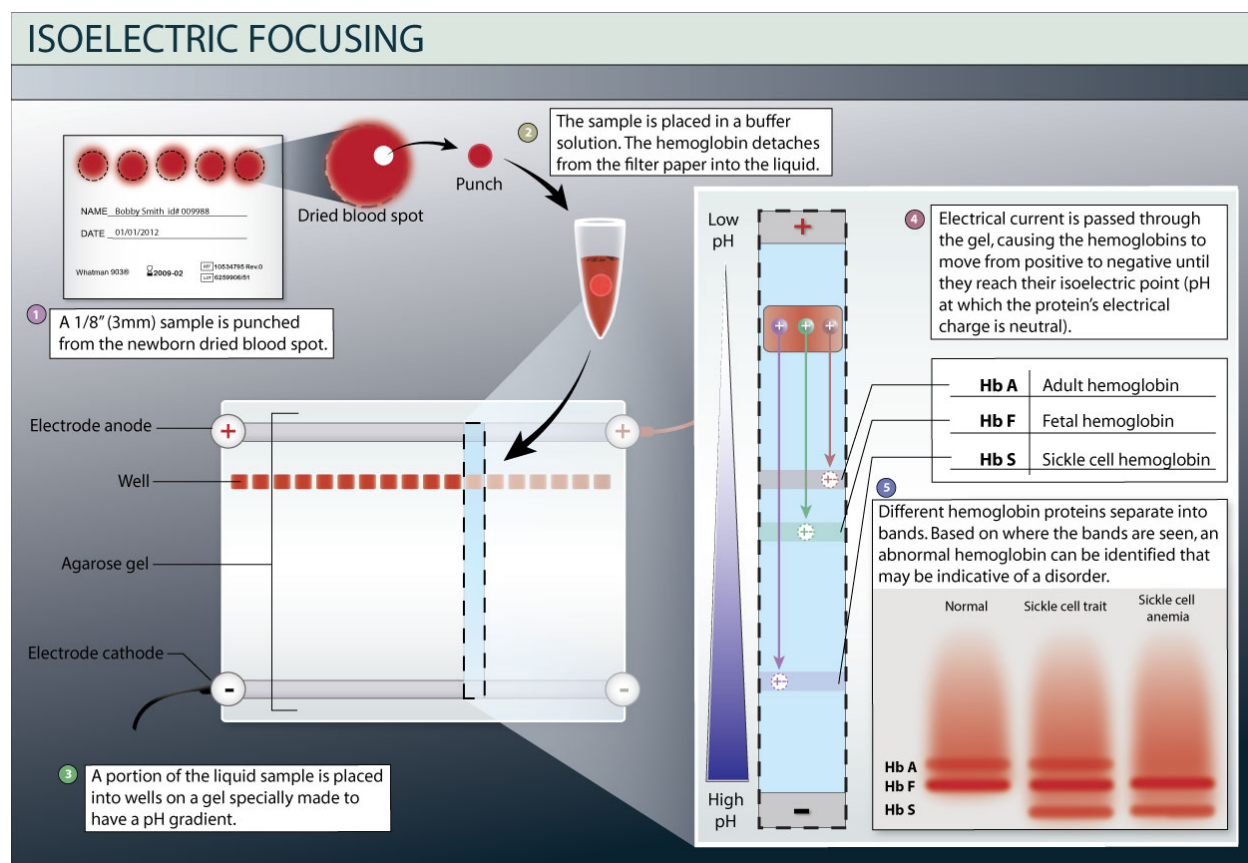

High Performance Liquid Chromatography (HPLC)

Hemoglobins are separated by an analytical cartridge in cation exchange HPLC using a preprogrammed buffer gradient with increasing ionic strength to the cartridge (Figure 3). The hemoglobin fractions separate based on their ionic interaction with the cartridge.²⁶ The separated fractions pass through a flow cell, where absorbance is measured at 415 nm and again at 690 nm to reduce background noise. Changes in absorbance are monitored over time producing a chromatogram (absorbance vs. time). Each hemoglobin has its own characteristic retention time and is measured from the time of sample injection into the HPLC to the maximum point of each peak. Identification of unknown hemoglobin is achieved through comparison with known hemoglobin retention times.²⁷ If a peak elutes at a retention time not predetermined, it is labeled as an unknown. HPLC achieves good separation and quantitation of HbF and HbA₂ in addition to screening for variant hemoglobins along with thalassemia. HPLC is highly reproducible, offers simplicity with automation, superior resolution and rapid results.²⁷ Some HPLC instrument programs can identify hemoglobinopathies from both newborns and adult specimens while others identify only one or the other. Identification between adult and newborn specimens depends on the algorithm/software/instrument specifications.

Figure 3. High-performance Liquid Chromatography

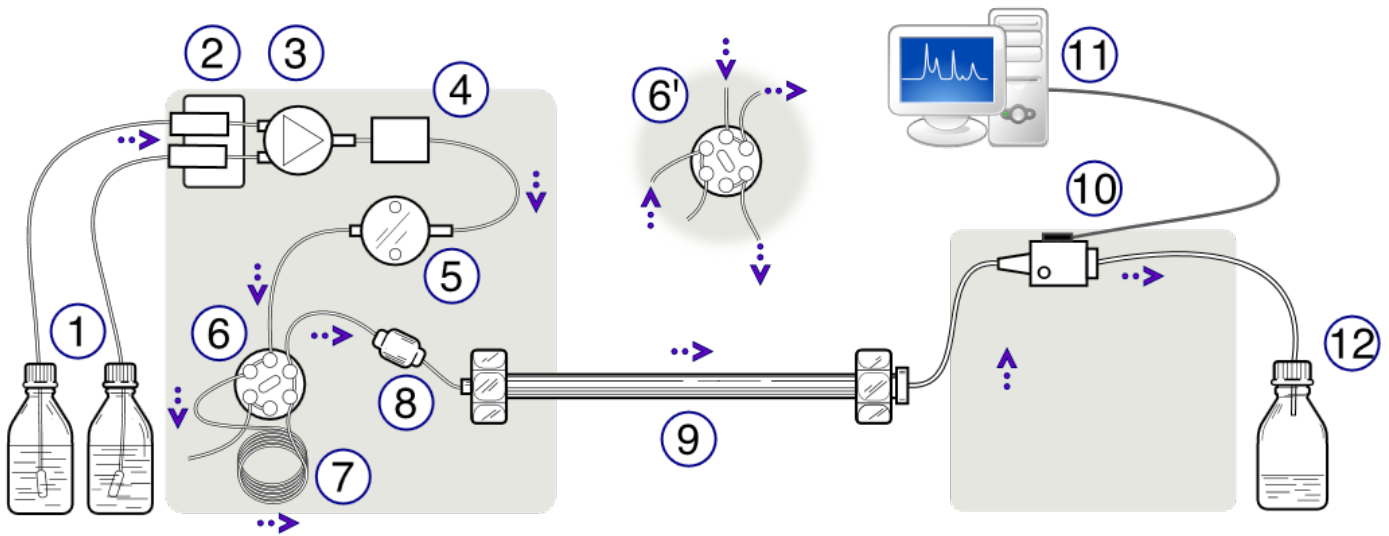

Schematic representation of an HPLC unit. (1) Solvent reservoirs, (2) Solvent degasser, (3) Gradient valve, (4) Mixing vessel for delivery of the mobile phase, (5) High-pressure pump, (6) Switching valve in "inject position", (6') Switching valve in "load position", (7) Sample injection loop, (8) Pre-column (guard column), (9) Analytical column, (10) Detector (i.e. IR, UV), (11) Data acquisition, (12) Waste or fraction collector. "HPLC apparatus" by WYassineMrabetTalk. This vector image was created with Inkscape. - Own work. Legend based on : *Practical High-performance Liquid Chromatography* by Veronika Meyer, 4th edition, John Wiley and Sons, 2004, ISBN 0470093781, p. 7 and chromatography-online.org. Used file: Computer n screen.svg (Crystal SVG icons). Licensed under CC BY-SA 3.0 via Wikimedia Commons

The following methods are used less frequently than those described above. Some methods have a long history within laboratories and continue to be used to clarify and confirm abnormal hemoglobins. Newer technology, like molecular methods, although utilized by few programs, is gaining momentum with some programs.

Cellulose Acetate Electrophoresis (Alkaline)

Cellulose Acetate Electrophoresis or alkaline electrophoresis makes use of the negative charge which hemoglobin will adopt under alkaline conditions. Samples are applied to cellulose acetate agar gel and hemoglobins are separated by electrophoresis using an alkaline buffer (Tris-EDTA with Boric Acid) at pH 8.4.²⁸ Each hemoglobin variant carries a different net charge so it will migrate at varying speeds. Following electrophoretic migration, visualization of hemoglobin bands are accomplished through staining with Ponceau S, Amino Black and Acid Violet or other similar stains and compared with known standards.^{3,26,28} Hemoglobins are quantified using densitometric scanning and the relative percentage of each band is determined.^{26,28} This method yields rapid and reproducible separation of HbA, HbF, HbS and HbC as well as other variant hemoglobins with minimal preparation time. However, due to limited sensitivity and because some hemoglobins are electrophoretically similar though structurally different, an alternative procedure must be incorporated into the screening algorithm for differentiation of these hemoglobins. For example, HbS, HbD, HbG and Hb Lepore co-migrate, so they are indistinguishable on alkaline electrophoresis. The same is true for HbC, HbA₂, HbO-Arab and HbE.^{13,24,28}

Citrate Agar Electrophoresis (Acid)

Electrophoresis occurs in an acidic environment at pH 6.2.²⁸ This method is based on the complex interactions of the hemoglobin with the electrophoretic buffer and the agar support. Staining allows visualization of hemoglobin bands. Acid electrophoresis allows confirmation of variant hemoglobins observed in the Cellulose Acetate Electrophoresis procedure and allows good separation of HbC from HbE and HbO-Arab.¹³ It permits additional separation of HbS from HbD and HbG.^{23,28} Citrate Agar electrophoresis appears to be more sensitive than Cellulose acetate for detecting HbF.

Alkaline Globin Chain Electrophoresis

The hemoglobin molecule can be separated into its globin chain components and heme groups by the addition of 2-mercaptoethanol and urea. At alkali pH, these globin chains will migrate to their characteristic position on a cellulose acetate strip, under an electrical field. The characteristic migration pattern aids in the identification of each globin chain type.²⁹

Capillary Zone Electrophoresis

Charged molecules are separated by their electrophoretic mobility in an alkaline buffer (pH 9.4) with separation occurring according to the electrolyte pH and endosmosis or electroosmotic flow.²⁵ Capillaries function in parallel allowing eight simultaneous analyses. Samples are hemolyzed and injected into the anodic end of the capillary. High voltage protein separation is performed and hemoglobins migrate from the anodic end of the capillary appearing in specific zones to the cathodic end where detection occurs at 415 nm. Results are assessed visually for abnormalities with identification of normal and disease patterns. There is improved detection of sickle cell disease due to separation of hemoglobin fractions which enables differentiation of HbS from other variants. Capillary zone electrophoresis allows clean separation of HbE from HbA2 and facilitates easier detection of HbBart's and HbH.²⁵

Figure 4. Principle of Hemoglobin Electrophoresis Using Capillary Electrophoresis Technologies

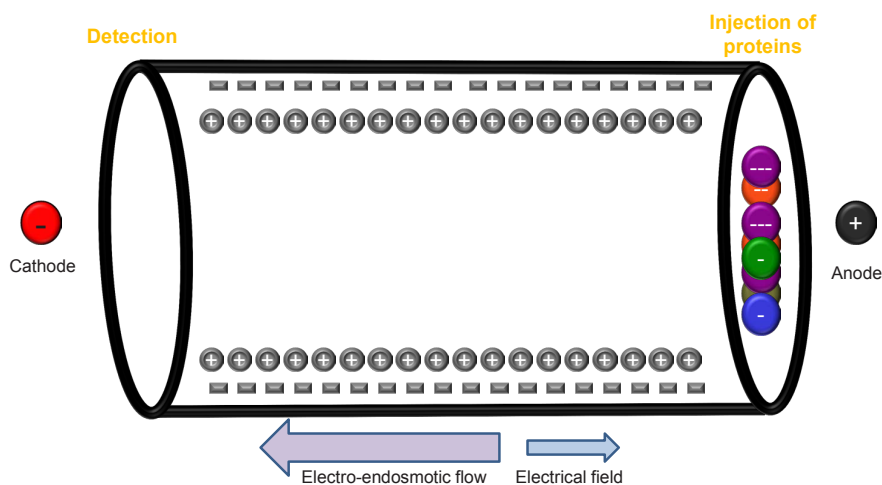

Figure 5. Capillary Diagram

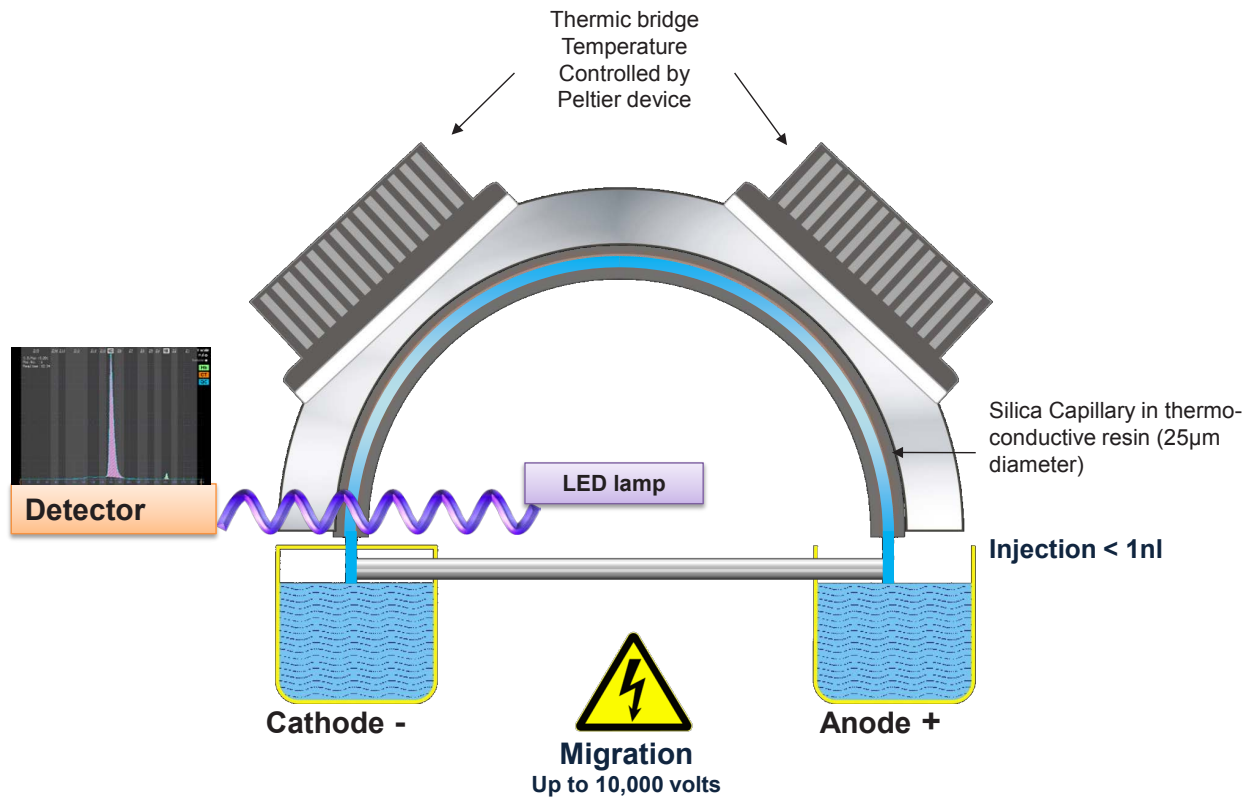
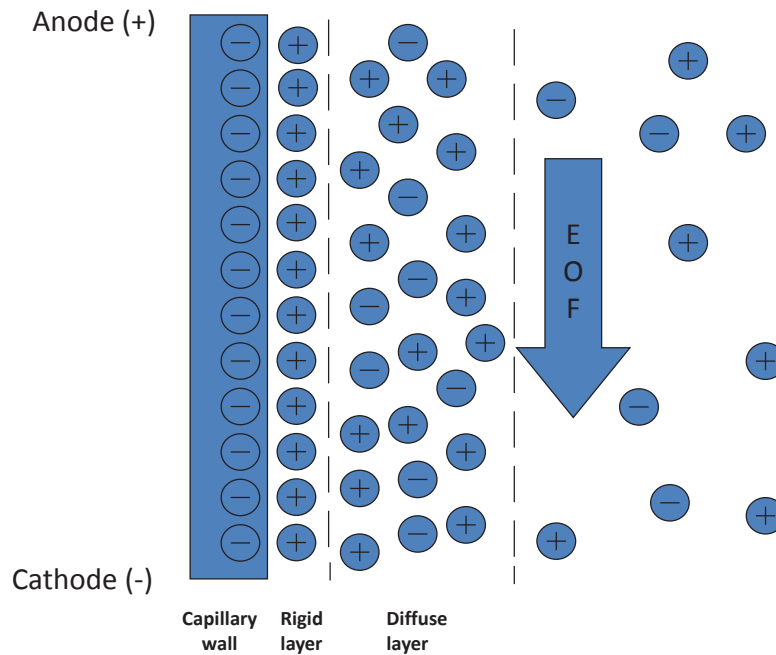

Figure 6. Net Flow of Buffer towards the Negative Electrode (Cathode)



Molecular Methods

Molecular testing for hemoglobinopathies generally uses three techniques. These are Restriction Fragment Length Polymorphism (RFLP), Allelic Discrimination using Real Time PCR end point data and DNA Sequencing. DNA extraction of whole blood in the DBS filter paper matrix is needed for all PCR-based assays. Methods for DNA extraction include crude boiling preparations, alkaline lysis preparations and commercial methods. Each one has its own benefits and limitations, and each laboratory needs to determine the best method for their applications.³⁰

Considerations for all Polymerase Chain Reaction (PCR) based assays

All molecular assays using PCR are susceptible to contamination by aerosolized amplicons. To minimize the risk of contamination, at a minimum, assay set-up and amplification/analysis must be separated and one-way directional work flow is required.³¹ Depending upon the volume of specimens tested and nature of the work, laboratories may require shoe covers and hair caps in addition to a laboratory coat and gloves.

Each PCR run must include a positive control (a genotype positive DBS or genomic DNA i.e., SS, SC, AS, AC, etc.) and a negative control, also referred to as a no template control (no DNA control i.e., water or reagent only). The positive control verifies that the amplification occurred and the negative control will detect contamination of reagents.

Restriction Fragment Length Polymorphism (RFLP)

RFLP takes advantage of recognition sequences of restriction enzymes that correspond to the normal allele or the mutated allele of a gene.³² If the recognition sequence is present, the restriction enzyme will restrict (cut) the DNA and the size difference can be visualized by gel electrophoresis (Appendix A, Figure 1).

To use RFLP, DNA is first extracted from DBS and amplified using polymerase chain reaction (PCR). The amplified DNA is added to the restriction enzyme reaction and incubated for a prescribed amount of time. An aliquot of the mixture is electrophoresed and the size(s) of the fragment(s) is visualized after staining, photographed and analyzed. For example, the S mutation in the beta-globin B (HBB) gene replaces an adenine with a thymine resulting in an amino acid change from a glutamic acid to valine. This change destroys the *Ddel* restriction enzyme recognition site. After amplifying a 125bp fragment of the HBB gene, an aliquot of the PCR reaction is added to a mixture containing the enzyme *Ddel*. After a prescribed amount of time, an aliquot of this reaction and a DNA molecular weight marker or DNA ladder is electrophoresed on an agarose gel. If the specimen has normal hemoglobin (HbAA), the enzyme cuts the DNA into 106bp and 19bp fragments. The 106bp band is visible, but the 19bp band is too small to see on the gel. If the only product seen is 125bp, both alleles have the S mutation (SS). The specimen would be considered to have both an A and S allele (AS) and is classified as a carrier if both the 125 and 106 bp bands are seen (Appendix A, Figure 1).³²

The benefits of this method are that it is very easy to perform and analyze and is inexpensive compared to the other molecular methods described below. The only instrumentation required is a PCR machine, a water bath, an electrophoresis unit and a camera. It is a low throughput method because there are a number of manual steps and the amount of time it takes to complete the assay; however it is a good choice for laboratories that have a small number of samples to test. A limitation of RFLP is that partial restriction (incomplete cutting) of the DNA could result in a homozygous specimen being interpreted incorrectly. A positive control of a known genotype is crucial to identify this problem. In cases of a double mutation like SC, if the restriction enzymes do not have similar activity conditions, two separate reactions are required.

Allelic Discrimination using Real-time PCR

Allelic Discrimination (AD) measures fluorescence at the end of PCR to determine if a mutation is present. For this technique, a forward and reverse primer spanning the area of interest are used as well as hydrolysis probes.^{32,33} Hydrolysis probes are oligonucleotides that have a fluorophor bound to the five prime (5') end and a quencher molecule bound to the three prime (3') end. When the quencher is in close proximity to the fluorophor, fluorescence cannot be detected. After DNA is extracted from the specimen, a PCR reaction with the forward and reverse PCR primers, DNA polymerase, nucleotide triphosphates, (dNTPs) and two probes is prepared. One probe corresponds to the normal sequence and the other corresponds to the mutant sequence. The fluorophor bound to each primer emits fluorescence at different wavelengths and can be distinguished. During PCR, the primers and probes bind to their complementary sequences. When DNA polymerase encounters the bound probe, the polymerase's 5'–3' exonuclease activity degrades it. The fluorescent molecule is released, separating it from the quencher and the fluorescence can be measured (Appendix A, Figure 2). Because amplification occurs exponentially, there is a large increase of fluorophors that are no longer in proximity to the quenchers. At the end of the amplification, the fluorescence is measured in a real-time PCR machine and the results are analyzed by the software. If the signal from only one probe is detected, the sample is homozygous for the sequence complementary to that specific probe. If the signals from both probes are detected, then the sample has both a mutant allele and a normal allele and is considered a carrier.

This method has a higher throughput than RFLP because the results are generated right after the amplification ends, with no further processing. All reactions take place in the PCR tube which never has to be opened, thus reducing the risk of contamination. The throughput can be increased by using 96- or 364-well PCR plates and automation. Limitations include an increased cost for the probes and the need for a real-time PCR machine. Although AD is considered a multiplexed assay, the limited number of filters in the PCR machines does not allow for a higher order of multiplexing.

DNA Sequencing

Sanger sequencing is the most comprehensive method of mutation detection and determines the exact sequence spanning the area of the primers used. Once DNA is extracted from the sample, it is amplified by PCR but in addition to the primers, the DNA polymerase and dNTPs, dideoxynucleotides (ddNTPs) are added. Each of the four ddNTPs has a specific fluorophor bound to it, which emits a signal at a different wavelength. During amplification, when one of the ddNTPs is incorporated, extension stops because the lack of a hydroxyl group does not allow for the addition of the next base. The ratio of dNTPs to ddNTPs is optimized to generate fragments that are one base different than the next. After amplification, the products are purified, typically by DNA precipitation or by spin column. They are loaded onto a capillary electrophoresis instrument that separates the products by size based on their charge. When the products move across the path of a laser in the instrument, each fluorophor emits a signal at a different wavelength and this information is captured, analyzed by the instrument software and the sequence is displayed (Appendix A, Figure 3).³⁴

The greatest benefit of this method is that every base change in the area of interest is determined including single nucleotide polymorphisms, small insertions and small deletions. Sequencing is a high-throughput method but all the sequence data must be reviewed by a trained technician, which can take a large amount of time depending on the length of sequence and the number of samples. For newborn screening laboratories, if sequencing is used for hemoglobinopathy screening, only the beta-globin gene, HBB, is usually sequenced because it is relatively small and the most common mutations tested are point mutations in HBB. The alpha-globin genes, HBA1 and HBA2, have greater than 96% sequence homology making sequencing of these genes more complicated. Many of the common alpha-thalassemia mutations are large deletions which cannot be found by sequencing

but can be found using gap PCR or Multiplex Ligation-Dependent Probe Amplification. Sequencing is the most expensive method compared to RFLP and AD because of the reagents, instrumentation, personnel, and review time required for analysis, but it provides the most comprehensive data for the beta-globin gene.

Programs use different approaches for hemoglobinopathy screening, confirmation and diagnosis. Newborn screening programs however do not routinely screen for the purpose of detecting alpha or beta thalassemias although screening methods may detect some forms of these hemoglobinopathies. Clinical presentation in conjunction with hematologic features exhibited in the complete blood count (CBC) and peripheral blood smear as well as iron studies aid in confirmation and diagnosis of thalassemias. Depending on the type of thalassemia diagnosed, family studies may be warranted along with genetic counseling.²⁴

To further improve screening and diagnosis of hemoglobinopathies including thalassemias, some laboratories are exploring the use of tandem mass spectrometry and whole genome sequencing. These methods are promising improved sensitivity and specificity for hemoglobinopathies. However as procedures advance, others become less ideal for screening. For example, HbS solubility test, although simple and easy to use, is characterized by false positives from other hemoglobin types and interfering substances that may be present in the sample. False negatives are commonly seen in patients with low hemoglobin or hematocrit levels. Other abnormal hemoglobins are not readily detected and result interpretation can be difficult due to the subjectivity of the test.²⁵ Lastly, the HbS solubility test cannot differentiate between carrier and disease state for sickle cell disease. Based on these limitations, solubility testing is not recommended.

Additionally, when deciding on which method is most appropriate for hemoglobinopathy detection, it is necessary to consider the benefits the method will bring to the individual program. Likewise, it is important to consider expense, throughput, ease of use and skills required for implementation and routine analysis. Methods also have different limitations that must be evaluated. For example, peak or band resolution, differentiation of hemoglobins and result interpretation are important limitations to evaluate. The next section explores some of the limitations of the more commonly used applications.

VII. Method Advantages, Limitations and Testing Strategy

As of 2015, half of all labs participating in the CDC Newborn Screening Quality Assurance Program's proficiency testing report that they are using IEF as their primary hemoglobinopathy method and the other half are using HPLC (Table 1). Both have advantages and limitations, therefore each program must examine them to determine which method is best for their lab. The optimal strategy is to combine multiple methods to confirm abnormal initial results. The reason for this is what appears to be a common trait on one method might actually be different on another. In these circumstances the reported result would be Hb variant trait.

Isoelectric focusing has the advantage of allowing the reader to view as many as 80 hemoglobin profiles per gel. This is very beneficial in high volume laboratories. Variant bands are easily distinguished on a gel when compared alongside normal Hb FA profiles and appropriate controls. However, hemoglobin bands can leak into neighboring profiles, be poorly focused, distorted or contaminated creating subjective interpretations. This can be overcome by having multiple analysts enter results followed by an experienced analyst who makes the final call. It is also difficult to quantitate hemoglobin bands when reading IEF patterns. Gel preparations are also labor intensive, time consuming, and involve multiple steps.

Figure 7. Normal Hemoglobin (HbAA) by IEF

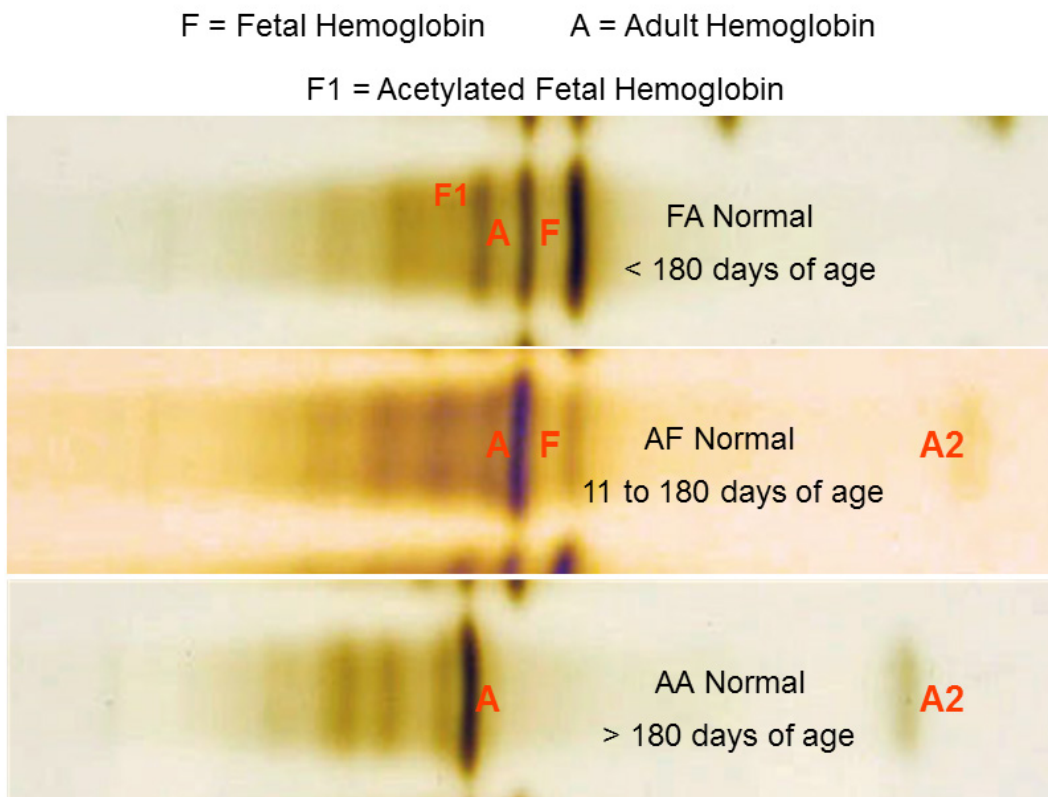
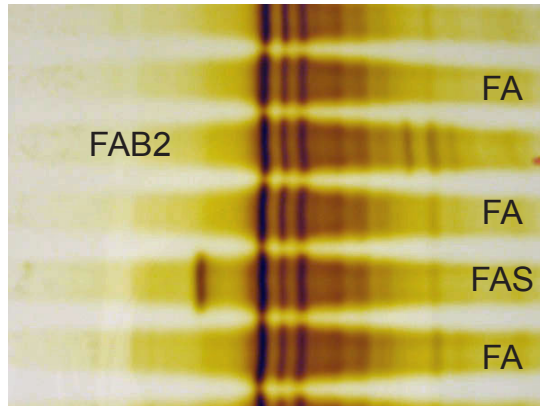
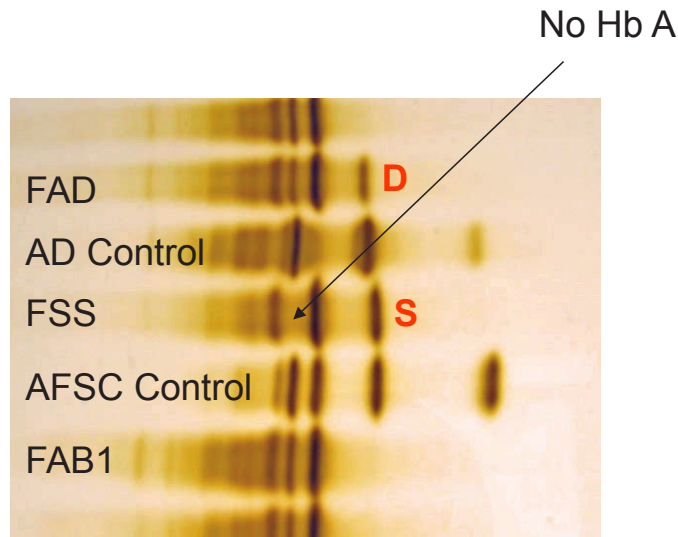

Figure 8. Sickie Cell Trait (Hb AS) by IEF



The image above is a good example of both alpha thalassemia (FAB2) and Hb S trait. FAS is also known as S trait due to the fact that it is a heterozygote (only 1 copy of chromosome 11 has the mutation for β^S). In a homozygous S, there is no A. Homozygous S is also called sickle cell disease and the phenotype code is HbSS.

Figure 9. Sickie Cell Disease (HbSS) by IEF



This example clearly illustrates the difference between HbS and HbD. Also note that there is no Hb A in the FSS profile. This child either has sickle cell anemia or Sickle beta zero, which will later be confirmed by DNA testing.

An advantage of using HPLC is that it typically includes software that calculates the percent area of each hemoglobin peak. This helps with the determination of thalassemias and phenotype reporting. Peaks within retention time windows can be identified by software algorithms, which also assists the analyst in making the final determination. However, the software determination should not be used to assign final phenotype results without examining each chromatogram. HPLC resolution can be low in some systems causing variant bands to be overlooked. A known issue with primary HPLC screening is system plugging due to filter paper fibers from the blood spot.

Figure 10. Sickle Cell Disease (HbSS) by HPLC

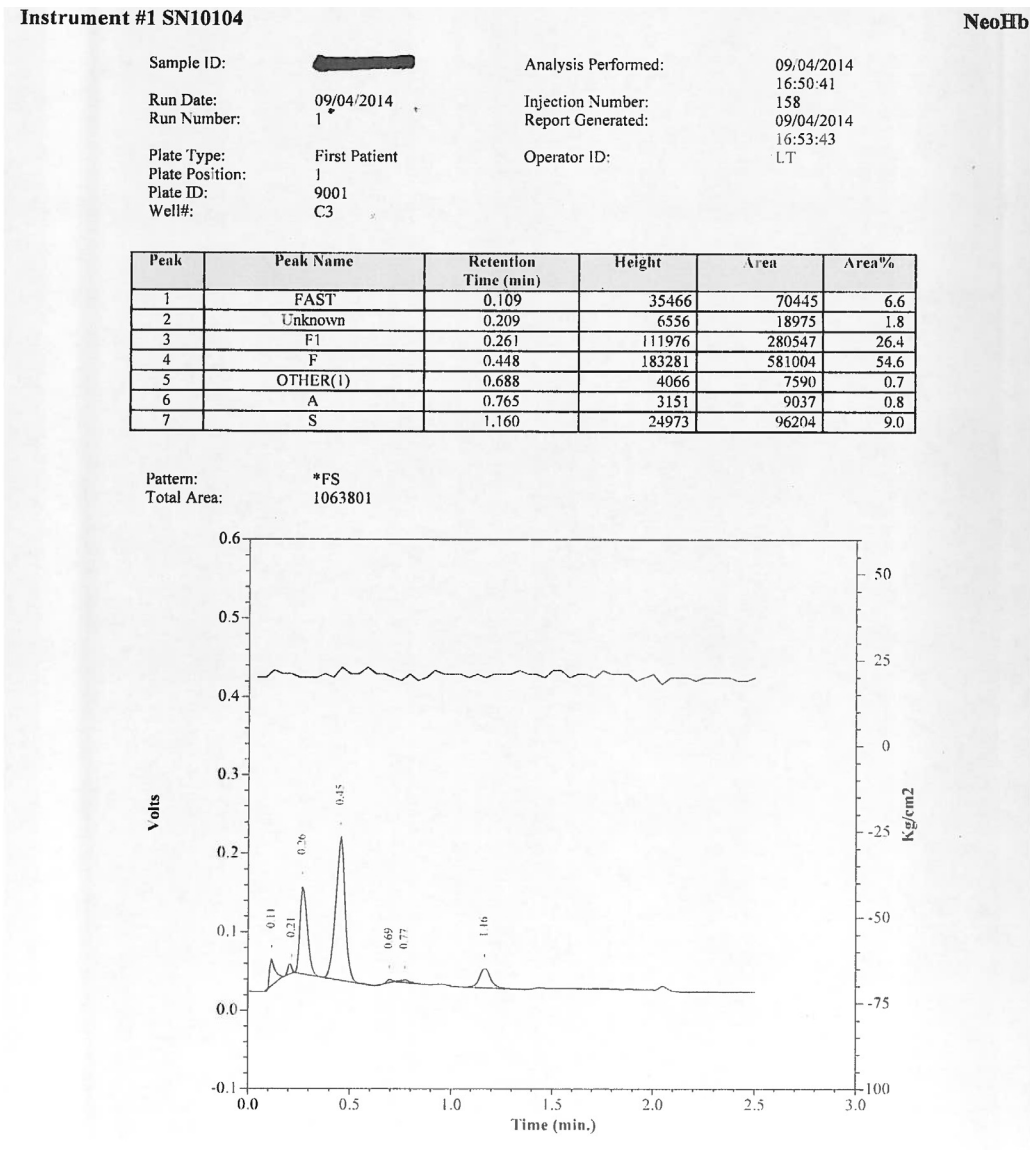
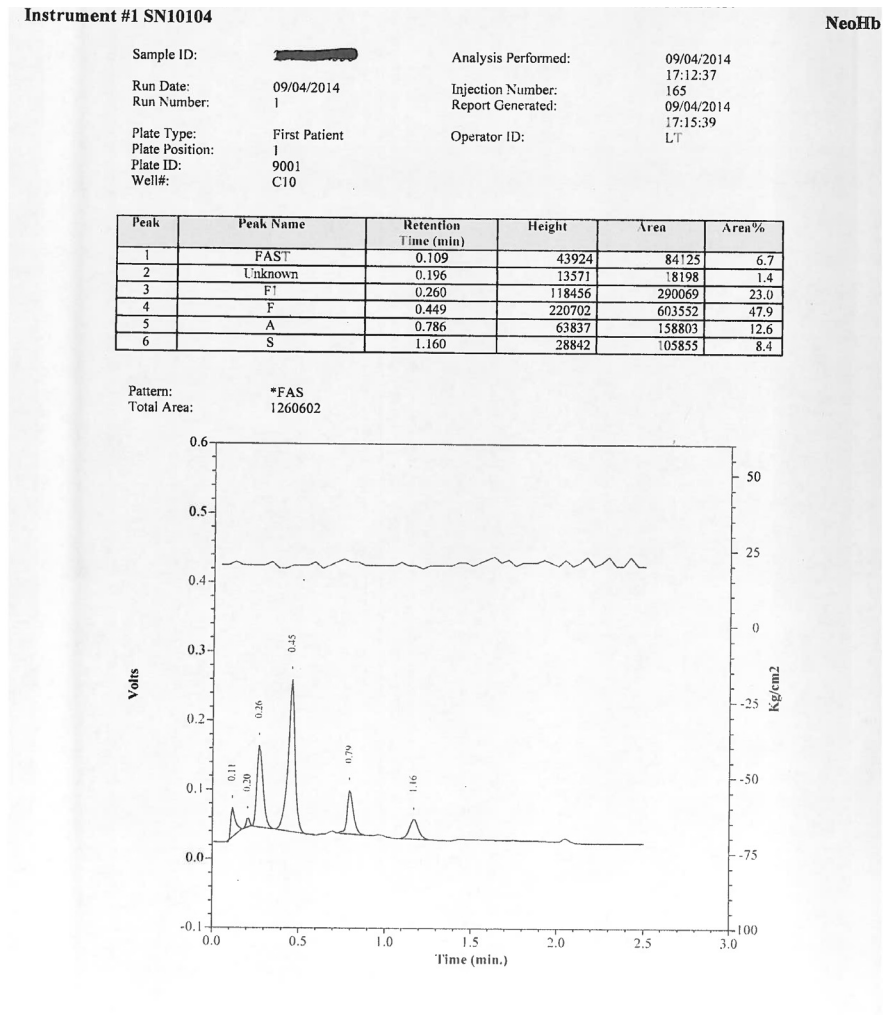

Figure 11. HPLC Sickle Trait



Capillary zone electrophoresis is commonly used in diagnostic laboratories and is an excellent choice in situations where few samples need to be run. Due to resolution and sensitivity, however, not all hemoglobin variants are detectable by this method. Similar to HPLC, this system also has problems with filter paper plugging.

Less commonly, citrate and cellulose acetate are being used by some laboratories. These methods have limited sensitivity and require alternative methods for differentiating abnormal hemoglobins sharing the same or similar electrophoretic mobility. Interpretations can be subjective.

Molecular testing can be added to resolve cases when the newborn has been transfused with packed red blood cells. Since the newborn's phenotype is masked by the donor, DNA testing can be used to identify any abnormal hemoglobins. This method is limited by workspace issues required for unidirectional flow, training and relatively high cost. Also, it is difficult to obtain proficiency and quality control materials which are required for certification through accreditation bodies.

Despite limitations and advantages, programs must consider how to effectively implement testing protocols for optimal workflow and efficiency for hemoglobinopathy detection. Specific examples of algorithms for hemoglobinopathy detection are provided in the Appendix. All algorithms presented despite their corresponding program aid in meeting the goal of early detection and diagnosis of hemoglobinopathies.

VIII. Algorithms for Hemoglobinopathy Detection

NBS programs have varying approaches to screening and reporting. Examples of this are provided in the Appendices starting on page 34. However, the goal is the same, to screen for those individuals who may be at risk for hemoglobinopathies. The basic screening process entails use of a primary method with some labs opting to use a secondary method depending on the type of hemoglobin initially detected. Reporting follows based on the result obtained. Methods differ in the ability to detect different hemoglobins, so understandably programs will also differ in what is typically reported due to method limitations. Additionally, programs may have different distribution of hemoglobins reported based on differences in population. To illustrate these variations seen in populations nationwide, the top 20 phenotypes reported by a sample of programs are provided in Appendix D.

Unknown Hemoglobin Variants

Invariably, NBS programs will identify unknown hemoglobin variants which may or may not be clinically significant. Most hemoglobin variants do not cause serious health problems, with the exception of a few. National consensus has yet to be established to guide newborn screening programs and clinicians in the follow up of infants with unidentified hemoglobin variants. Final identification of unknown variants can be achieved through DNA analysis and consultation with a hemoglobin specialist for possible clinical implications.

Once a variant hemoglobin is identified through screening, it should be confirmed by a secondary or alternate method. The American College of Medical Genetics has outlined the algorithm below specifically for Hb S screening and confirmation and subsequent actions for confirmed SCD and HbS trait (Figure 12).

Figure 12. Newborn Screening Confirmatory Algorithm

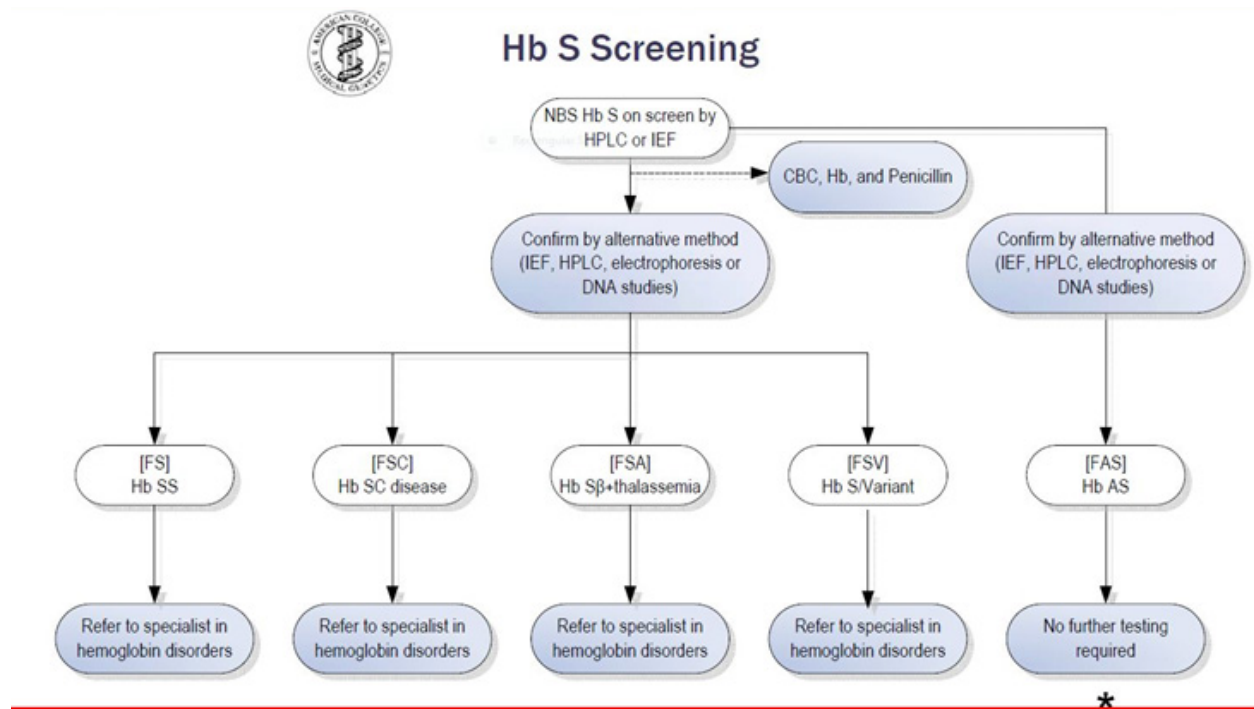

Abbreviations/ Key: F, S, A, C, and V = The hemoglobins seen in neonatal screening; HPLC: High performance liquid chromatography; IEF: Isoelectric focusing; ‡ = Repeat testing at 6 months age is required if genotyping to confirm the newborn screening result is not done.

Source: Adapted from American College of Medical Genetics, 2009 and Dr. Aguinaga-NBS for Hemoglobinopathies in TN, from the 11th Annual Research Symposium in Obstetrics and Gynecology at Meharry Medical College-Nashville, TN. 2014.

Figure 13. Basic Hemoglobinopathy Testing Process

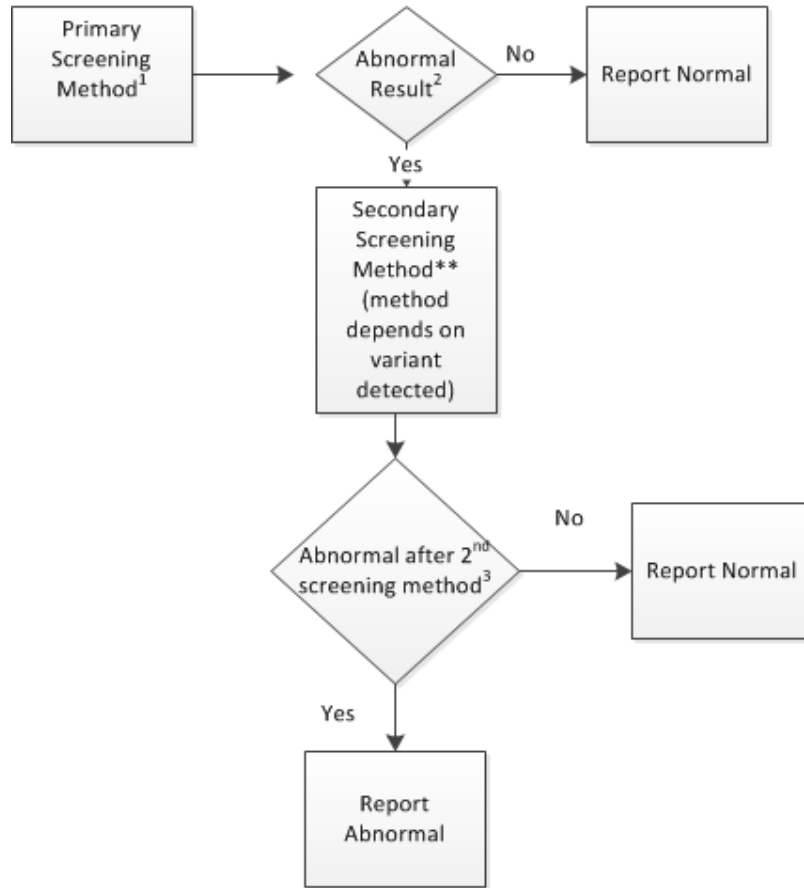

1. Primary screening methods are commonly IEF or HPLC depending laboratory

2. Note if unsuitable (because of specimen or test quality) result is obtained from primary screen, primary screen method is usually repeated before moving to next step

3. Secondary screening methods are commonly IEF, HPLC, or Molecular method depending type of variant detected by primary screening method and laboratory

Both IEF and HPLC carry the risk of missing a baby with SCD through misdiagnosis: babies with SCD-S/beta-plus thalassemia may be mistakenly reported as having sickle cell trait (FAS). A small number of babies inheriting the sickle gene and deletional type hereditary persistence of fetal Hb (HPFH) Types 1 or 2, with pancellular distribution of Hb F shows FS on these assays and can be misdiagnosed as having sickle cell anemia (FSS). Compound heterozygotes of HbS-deletional type HPFH have mild microcytosis and do not have features of sickle cell disease, like the vaso-occlusive crises or hemolytic anemia.³⁵

Regardless of the algorithm employed, a laboratory program must consider and institute quality assurance and quality control (QA/QC) activities. Pre-analytic, analytic and post-analytic phases are crucial to the proper function of the laboratory system and reporting of quality and accurate results. A description of QA/QC protocols are briefly discussed in the following section with information provided on the activities of each phase.

IX. Quality Assurance for Hemoglobinopathy Screening and Testing

Quality Assurance (QA) is defined as, “a program for the systematic monitoring and evaluation of the various aspects of a project, service, or facility to ensure that standards of quality are being met” and is often split into three categories, pre-analytic, analytic and post-analytic.³⁶ This section focuses on the analytic phase and briefly describes issues in the pre-analytical and post-analytical phases.

Pre-analytical Phase

For newborn screening, this phase includes variables such as specimen collection devices, quality of specimen collection and transport to the testing facility. Performance evaluation indicators may include the percentage of unsatisfactory specimens (as determined by each program) received and the percentage of specimens that are delayed in transport.

Analytical Phase

This phase includes all factors related to the laboratory testing. A laboratory quality assurance program should follow any regulatory guidelines that are applicable. Generally, the laboratory QA program has components listed below, at a minimum:

- A standard operating procedure detailing the testing method, how to interpret results and how to resolve problems that may arise
- Flow charts/responsibilities/actions to clarify the role of each person involved in the analysis
- Quality control (QC) materials to monitor the method over time
- Documentation of any corrective actions taken
- Proficiency Testing (PT) an external quality assessment to monitor the laboratory’s performance

The most useful QC and PT materials are those in the same matrix as the specimens being tested. The materials should include specimens classified as normal as well as those with hemoglobinopathies. Because of the high amount of fetal hemoglobin present in newborn DBS, PT for hemoglobinopathy screening requires umbilical cord blood to prepare DBS. Availability of umbilical cord blood with hemoglobinopathies is scarce and there are only two programs that provide PT, CDC’s Newborn Screening Quality Assurance Program (NSQAP) and the United Kingdom National External Quality Assessment (UKNEQAS). If the PT program does not provide specimens for the hemoglobinopathies tested, laboratories may follow guidelines published in CLSI document GP29-A2.42 No QC materials in the DBS matrix are available for hemoglobinopathy screening.³⁷

For sickle cell disease and other hemoglobinopathies, NSQAP sends panels of five blind-coded DBS PT specimens to participating laboratories three times per year. Participants are asked to test the panel and for each specimen, report the method(s) used, the presumptive phenotype, the presumptive clinical assessment and any other clinical classifications that are consistent with their program operations. An individualized evaluation is provided back to each participant. NSQAP summary reports can be publically downloaded at http://www.cdc.gov/labstandards/nsqap_reports.html.

If a participant has an error in a PT survey, NSQAP staff will contact the laboratory to help them understand how the error occurred so that measures can be put in place to reduce the risk of the error happening again. Due to the limited amount of specimens available, there is currently a waiting list to join this program.

The UKNEQAS provides a PT program for sickle cell and other abnormal hemoglobinopathies in DBS. It provides three specimens each month. Further information the web address is <http://www.ukneqas.org.uk>.

Post-analytical Phase

The post-analytical phase includes the transmittal of the screening laboratory results and determination of what actions were taken regarding positive screen results.

Newborn screening is an entire system, beginning at the hospital and continuing through to the diagnosis of the child. Each part of the newborn screening system is important and needs evaluation of any weaknesses. If more information about quality management is necessary there are many resources including consensus documents from Clinical Laboratory Standards Institute (www.clsi.org), World Health Organization's "Laboratory quality management system: handbook" that can be downloaded from their website at <http://www.who.int/ihr/publications/lqms/en/> and accreditation organizations such as ISO (www.iso.org).

Communicating positive screen results to a doctor and/or parents and tracking outcomes of diagnostic testing are of primary concern. Follow-up processes for newborn screening primarily aim to quickly locate an infant with sickle cell disease for diagnosis and treatment. Although protocols do vary between programs, the subsequent information focuses specifically on SCD follow-up versus non-disease reporting and trait reporting. Additionally, varying algorithms from state programs have been included for review.

X. Follow-up

The goal of short-term follow-up is to ensure that all who receive a valid screening test, and screen positive results, receive a definitive diagnosis in the most expedient manner possible and appropriate clinical management if confirmed.³⁸ The sequence of actions that must take place successfully to ensure achievement of this goal includes:

- Access to the newborn within days of birth or to non-newborns when possible;
- Collection of adequate blood and prompt submission to the designated laboratory;
- Performance of screening laboratory test;
- Correct interpretation of screening test results;
- Notification and dissemination of screening results to appropriate personnel required to facilitate achievement of the primary goal;
- Referral to primary healthcare provider and/or specialist.
- Initiation of penicillin prophylaxis for SCD or therapies for other hemoglobinopathies
- Diagnostic testing to confirm screening test results; and,
- Establishment of comprehensive care in a Medical Home.

Follow-up for Hemoglobinopathies

While follow-up of those with presumptive SCD has a clear purpose, the purpose of follow-up of those with other hemoglobinopathies is less clear but has the same potential problems. Successful implementation of follow-up involves the following:

- Productive relationships between the screening laboratory and follow-up staff,
- Selection and training of staff reporting results to the family, and
- Processes or algorithms for follow-up.

Relationships between laboratory and follow-up staff

In some NBS programs the screening laboratory reports directly only to staff of the state NBS program to which all results are transmitted. In others, the laboratory also reports directly to the hospital of birth and to the listed primary healthcare provider for the baby. Since newborn screening for SCD is uniformly state-mandated, the state is responsible for implementation and monitoring of the screening program, or its contracted follow-up agency. Either entity should be the direct recipient and distributor of screening results. Increasingly, follow-up staff and healthcare providers have direct electronic access to the laboratory results held by the state.

By whatever method of communication between laboratory and follow-up staff, two issues are important: first, no single screening test can establish with certainty the phenotype of all the common types of SCD and related conditions, and second staff at the laboratory and follow-up agency must be fully familiar with the nomenclature of Hb phenotypes reported by the lab and their clinical significance.

Selection and training of staff reporting results to the family

Reporting results for affected individuals and reporting about those with non-disease conditions should be fundamentally different. Two types of staff, one with a clinical background and the other with or without clinical background should be trained to report results. Training should equip both types of staff with basic knowledge about SCD and related thalassemia conditions, their variants and their inheritance patterns, and the difference between benign carrier states and clinically significant diseases.

Staff who are reporting results for affected individuals should be familiar with the clinical course of SCD in infants and young children, be able to answer basic questions about SCD or the suspected related disease, and be ready to provide reassurance and support for the family. If staff are not familiar with children with SCD, their training should include an internship at a Sickle Cell Center where they can observe children with SCD in both outpatient and inpatient settings. This will enhance and make more realistic the knowledge acquired through instruction, or reading and video learning materials.

The purpose and value of counseling related to a baby with sickle cell trait or other clinically benign hemoglobin conditions or to a baby with no abnormal Hb on newborn screening is not always clear. Any family whose newborn is tested for any disorder deserves to receive results and have their implications explained. This could be done through staff at a primary health care facility or another agency contracted by the state. However, several programs imply, by design, that newborn screening opens a window for genetic education and counseling of the parents for future reproductive planning. Follow-up staff reporting newborn screening results must have some knowledge of the genetics of hemoglobin disorders.

Process or algorithms for follow-up

Affected individuals: Notification of a family about a (presumptive) serious health problem in an otherwise healthy appearing newborn is not a trivial task. Ideally, notification should be done in person or by live phone call. The initial conversation should be expected to raise anxiety, and cause disappointment and sadness at a time of joy; it may also stir anger or denial. The messenger should be someone familiar with the clinical course of SCD in infants, young children and adults, and be able to answer basic questions about SCD and ready to provide reassurance and support for the family.

The processes and algorithms for notification and follow-up often place the primary care service as the medical home, presuming that staff is able to interpret screening results and take appropriate actions when a baby with a positive screen is reported. Reporting individuals with abnormal screening results to a dedicated follow-up agency and/or sickle cell treatment center will increase the timeliness of appropriate care.

In the best circumstances, each child with presumptive SCD should be assigned to one case manager who handles the baby from screening test results through establishment at the medical home and sickle cell treatment center, where available.

Non-affected individuals: All parents should be informed about the results of newborn screening. Informing parents about results of newborn screening that carry no clinical significance should be handled with calmness and reassurance. Algorithms for reporting and following up babies with HbFA on screening should not classify them as “Normal” or “Within Normal Limits;” they should be reported as “No Abnormal Hb Found.” While FA is the Hb phenotype of most babies with no hemoglobin disorder, babies with FA may be found later to have mild to severe beta or alpha thalassemia or transfusion-dependent thalassemia.

“Trait Counseling” of parents of heterozygous babies has become an integral part of newborn screening programs for hemoglobin disorders. However, an FA baby may be born to parents who BOTH have sickle cell trait or, one may have sickle cell trait while the other is a carrier of another abnormal hemoglobin or beta thalassemia. Such parents can have a subsequent baby who has SS or another type of SCD.

Follow up activities for adults who screen positive for a hemoglobinopathy trait: It is important to screen at risk individuals for hemoglobinopathies, who are at reproductive age and who may not have been screened at birth.

Dissemination of information about the relevance of adult screening and participation in community outreach activities, such as community screenings and health fairs is very important for individuals who have not been previously tested.

If an adult individual has a positive diagnosis for a hemoglobinopathy trait, proper follow-up should ensure the understanding of the trait condition, with full explanation of the results, education about the trait (including any possible complications or rare clinical manifestations), counseling and the offering of hemoglobinopathy testing for the partner, if the couple is contemplating having children. Counseling should include the probability of the couple having a child with a hemoglobinopathy in each pregnancy.

XI. References

1. Hsieh MM, Fitzhugh CD, Weitzel RP, Link ME, Coles WA, Zhao X, Rodgers GP, Powell JD, Tisdale JF. (2014 Jul 2). Nonmyeloablative HLA-Matched Sibling Allogeneic Hematopoietic Stem Cell Transplantation for Severe Sickle Cell Phenotype. *JAMA*.;312(1):48-56. doi: 10.1001/jama.2014.7192. PMID: 25058217.
2. A.D.A.M. Medical Encyclopedia [Internet]. Atlanta (GA): A.D.A.M., Inc.; ©2005 Thalassemia; [updated 2014 Feb 24; cited 2015 Apr 10]. Available from: <http://www.nlm.nih.gov/medlineplus/ency/article/000587.htm>
3. Tietz: Fundamentals of Clinical Chemistry, (6th Edition). Burtis, C. A., Ashwood, E. R., Bruns, D.E. (Eds.). (2008). Haryana, India: Elsevier. Pages:
4. National Library of Medicine. (2009) HBB. Retrieved from <http://ghr.nlm.nih.gov/gene/HBB>
5. National Library of Medicine. (2009) Alpha thalassemia. Retrieved from <http://ghr.nlm.nih.gov/condition/alpha-thalassemia>
6. Ashley-Koch, A., Yang, Q., Olney, R.S. (2000). Sickle hemoglobin (Hb S) allele and Sickle Cell Disease: A HuGE Review. *American Journal of Epidemiology*, 151(9), 839-845.
7. Watson, M. S., Mann, M. Y., Lloyd-Puryear, M. A., Rinaldo, P., Howell, R. R., (2006). Newborn Screening: Toward a uniform screening panel and system-executive summary. *Pediatrics*, 117(5), S296-S307.
8. Aguinaga, M.d.P. (2007). Newborn Screening and Clinical Management of Children with Sickle Cell Disease. *Frontiers of Science in the 21st Century*. pg 137-147. Ed Cordillera. Lima, Peru.
9. Consolidated Annual Report. (1973). US Department of Health, Education, and Welfare. Public Health Service, Center for Disease Control, Atlanta, GA. pg 149. <https://archive.org/details/consolidatedannu19cent> Accessed on 02/11/2015.
10. Editorial Note on Update: Newborn Screening for Sickle Cell Disease — California, Illinois, and New York, 1998. *CDC MMWR Weekly*, August 18, 2000/49(32); 729-731.
11. Thuret I, Sarles J, Merono F, et al. Neonatal Screening for Sickle Cell Disease in France: evaluation of the selective process. *J. Clin. Pathol.* 2010 Jun 63(6):548-51. doi: 10.1136/jcp.2009.068874.
12. Benson JM, Therrell Jr BL: History and Current Status of Newborn Screening for Hemoglobinopathies. *Seminars in Perinatology* 2010; 34:134-144.
13. Gaston, M.H., Vertel, J.I., Woods, G., et al. Prophylaxis with Oral Penicillin in Children with Sickle Cell Anemia. *N Engl J Med* 1986; 314:1593-1599.
14. Chandrakasan S, Kamat D: An Overview of Hemoglobinopathies and the Interpretation of Newborn Screening Results. December 2013 *Pediatric Annals*, 42:12; 502.
15. Yanni E, Grosse SD, Yang Q, Olney RS. Trends in pediatric sickle cell disease-related mortality in the United States, 1983-2002. *J Pediatr.* 2009; 154(4):541-5. doi: 10.1016/j.jpeds.2008.09.052. Epub 2008 Nov 22.
16. Michlitsch J, Azimi M, et al. Newborn Screening for Hemoglobinopathies in California. *Pediatric Blood Cancer.* 2009; 52(4):486-490.

17. National Newborn Screening and Genetic Resource Center (NNSGRC). Laboratory Testing for Hemoglobinopathies, 2010.
18. Clinical and Laboratory Standards Institute: NBS01-A6, Blood Collection on Filter Paper for Newborn Screening Programs; Approved Standard – Sixth Edition; July 2013.
19. William Joseph William: Williams Hematology, Volume 487-Sixth Edition, 2001.
20. Clinical and Laboratory Standards Institute: GP42 – A6, Procedures and Devices for the Collection of Diagnostic Capillary Blood Specimens; Approved Standard-Sixth Edition, Wayne, PA: Clinical and Laboratory Standards Institute; 2008.
21. Barbara Adam et al: Stabilities of hemoglobins A and S in dried blood spots stored under controlled conditions: Clinical Biochemistry 46 (2013) 1089-1092.
22. A.L. Okwi et al: The Reliability of Sickling and Solubility Tests and Peripheral Blood Film Method for Sickle Cell Disease Screening at District Health Centers in Uganda: Clinics in Mother and Child Health Vol. 7(2010), Article ID C10947.
23. Clinical and Laboratory Standards Institute: ILA31-A : Newborn Screening for Pre-term, Low-birth Weight and Sick newborns. Approved Standard - Volume 29 Number 24, 2009.
24. Clarke GM, Higgins TN. Laboratory Investigation of Hemoglobinopathies and Thalassemias: Review and Update. Clinical Chemistry 46:8(B) 1284-1290, 2000.
25. Keren et al. Comparison of Sebia Capillary Electrophoresis with the Primus High Pressure Liquid Chromatography in the Evaluation of Hemoglobinopathies. American Journal of Clinical Pathology 130:824-831, 2008.
26. Therell BL, Pass KA. Hemoglobinopathy Screening Laboratory Techniques for Newborns: Laboratory Methods for Neonatal Screening. Washington DC: American Public Health Laboratories. 1993. Pages 169-189.
27. Joutovsky et al. HPLC Retention Time as a Diagnostic Tool for Hemoglobin Variants and Hemoglobinopathies: A Study of 60,000 Samples in a Clinical Diagnostic Laboratory. Clinical Chemistry 50:10 1736-1747, 2004.
28. Hicks EJ, Hughes, BJ. Comparison of Electrophoresis on Citrate Agar, Cellulose Acetate or Starch for Hemoglobin Identification. Clinical Chemistry 21:8 1072-1076, 1975.
29. Ueda S, Schneider RG. Rapid Identification of Polypeptide Chains of Hemoglobin by Cellulose Acetate Electrophoresis of Hemolysates. Blood 1969; 34:230.
30. Cordovado, SK. 2013. Dried Blood Spot DNA Extraction Guidelines to Ensure Robust Performance in NBS Molecular Assays. [PowerPoint slides] (in italics). Retrieved from the Association of Public Health Laboratories website: <http://www.aphl.org/conferences/proceedings/Documents/2013/2013-Newborn-Screening-Symposium/25Cordovado.pdf>
31. Mifflin TE. 2003. Setting Up a PCR Laboratory. In: Dieffenbach CW and Dveksler GS, editors. PCR Primer: a Laboratory Manual. 2nd edition. Cold Spring Harbor, NY; Cold Spring Harbor Laboratory Press. p. 5-14. (May be downloaded from http://www.biosupplynet.com/pdf/O1_PCR_Primer_p.5_14.pdf)
32. Saiki, RK; Scharf S, Faloona F, Mullis KB, Erlich HA, Arnheim N. 1985. Enzymatic amplification of beta-globin genomic sequences and restriction site analysis for diagnosis of sickle cell anemia.

Science 230: 1350–1354.

33. Yao-Hua Zhang Y-H and McCabe ERB. 1992. RNA analysis from newborn screening dried blood specimens. *Hum Genet* 89:311-314.
34. Sanger, F., Nicklen, S., and Coulson, A.R. 1977. DNA sequencing with chain terminating inhibitors. *Proc. Natl. Acad. Sci (USA)* 74: 5463–5467.
35. Akinsheye I, Alsultan A, Solovieff N, Ngo D, Baldwin CT, Sebastiani P, Chui DHK, Steinberg MH. Fetal hemoglobin in sickle cell anemia. *Blood*. 2011; 118:19-27.
36. “Quality Assurance.” Merriam-Webster.com. Merriam-Webster, n.d. Web. 19 May 2014. [http://www.merriam-webster.com/dictionary/quality assurance](http://www.merriam-webster.com/dictionary/quality%20assurance)
37. Clinical and Laboratory Standards Institute: GP29-A2 Assessment of Laboratory Tests When Proficiency Testing Is Not Available; Approved Guideline—Second Edition. Wayne, PA: Clinical and Laboratory Standards Institute; 2008.
38. Clinical and Laboratory Standards Institute: NBS02-A2 Newborn Screening Follow-up; Approved Guideline – Second Edition Wayne, PA: Clinical and Laboratory Standards Institute; May 2013

XII. Appendices

Appendix A: Examples of Molecular Methods for Hb Mutation Detection

Figure 1. PCR-RFLP

Step 1 Amplify area of interest by PCR

Step 2 Restrict with enzyme (DdeI)

Step 3 Analyze by gel electrophoresis

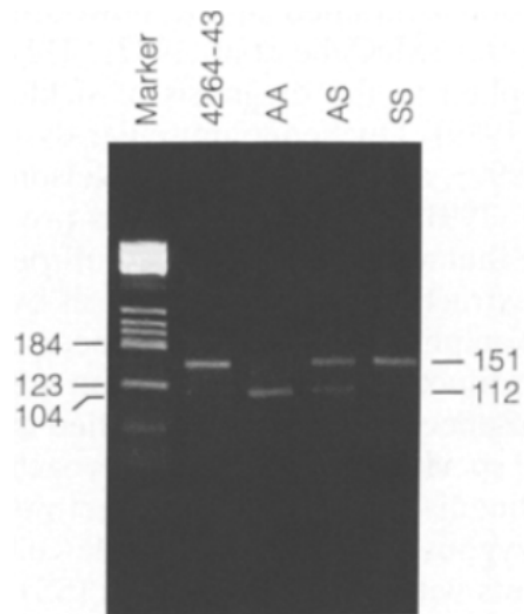
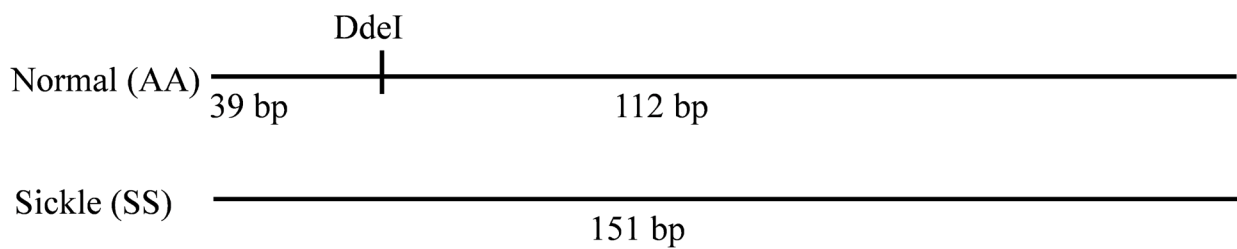

Gel picture from Yao-Hua Zhang Y-H and McCabe ERB. 1992. RNA analysis from newborn screening dried blood specimens. Hum Genet 89:311-314.

Figure 2. Allelic Discrimination

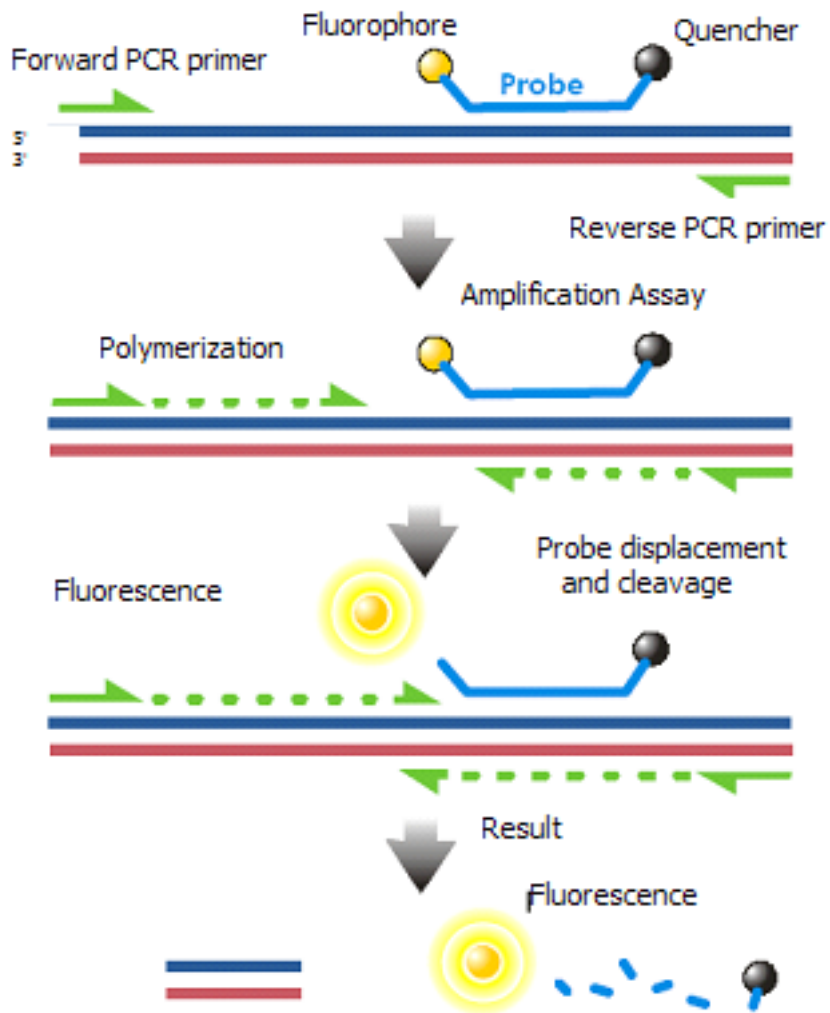

<https://en.wikipedia.org/wiki/TaqMan> Accessed May 19, 2014. Use of trade names is for identification only and does not imply endorsement by the Centers for Disease Control and Prevention, the Agency for Toxic Substances and Disease Registry, the Public Health Service, or the U.S. Department of Health and Human Services.

Figure 3. Sanger Sequencing

1 Reaction mixture

- Primer and DNA template
- DNA polymerase
- ddNTPs with flouochromes
- dNTPs (dATP, dCTP, dGTP, and dTTP)

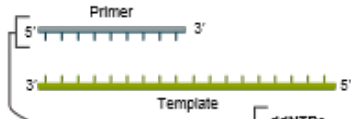
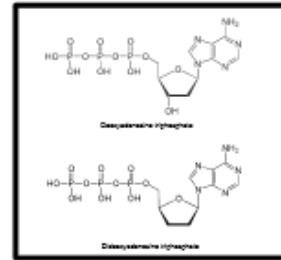

2 Primer elongation and chain termination

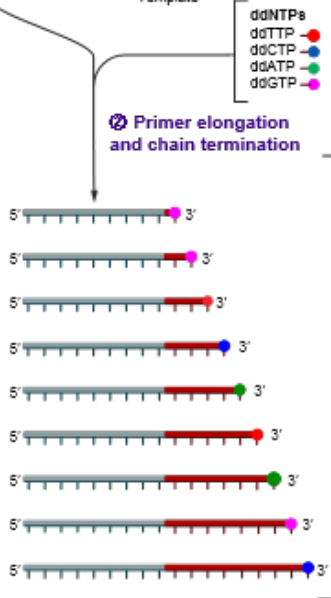

3 Capillary gel electrophoresis separation of DNA fragments

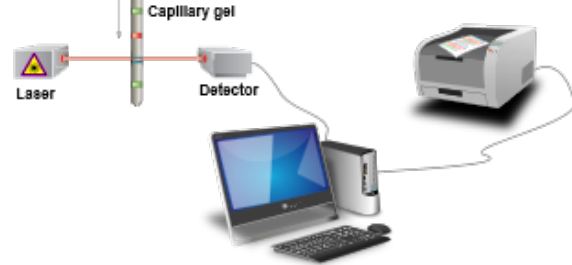

4 Laser detection of flouochromes and computational sequence analysis

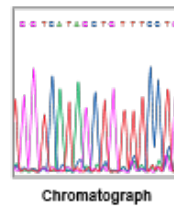

By Estevezj (Own work) [CC BY-SA 3.0 (<http://creativecommons.org/licenses/by-sa/3.0>)], via Wikimedia Commons

Appendix B

Top 20 Hemoglobinopathies in State 1: 2008-2012

1	Hb S Trait
2	Low Bart's, Alpha Thalassemia *
3	Hb C Trait
4	Other Variant Trait
5	Moderate Bart's, Alpha Thalassemia
6	Hb E Trait
7	Hb D Trait
8	Hb S Disease
9	HB SC Disease
10	Hb G Trait
11	Elevated Bart's, Hb H Disease
12	Hb E Disease
13	HB C Disease
14	S, Beta Thalassemia
15	Hb O-Arab Trait
16	Beta Thalassemia Major
17	Hb S, Other Disease
18	Hb E Trait and H Disease
19	Hb SE Disease
20	C, Beta Thalassemia

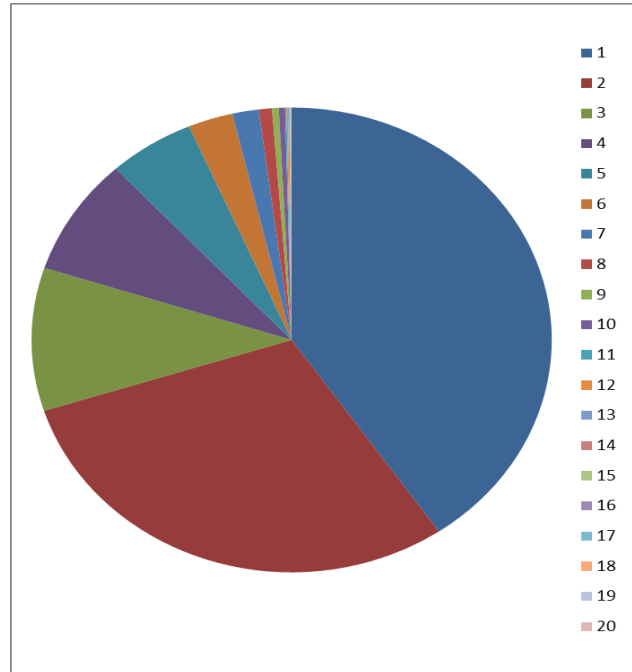

* Low level Bart's no longer reported after June 27 2011.

Top 20 Hemoglobinopathies in State 2: 2008-2012

1	fas	10166	50.22%
2	barts	5022	24.81%
3	fac	3018	14.91%
4	fav	903	4.46%
5	fae	362	1.79%
6	fad	248	1.23%
7	Sickle Cell	173	0.85%
8	Sickle C	112	0.55%
9	fagv	70	0.35%
10	S/B+	32	0.16%
11	fasv	29	0.14%
12	C/B+	21	0.10%
13	faev	18	0.09%
14	fadv	17	0.08%
15	C	14	0.07%
16	fag	9	0.04%
17	S/B0	8	0.04%
18	facv	8	0.04%
19	Thal Major	7	0.03%
20	E	5	0.02%
	total	20242	

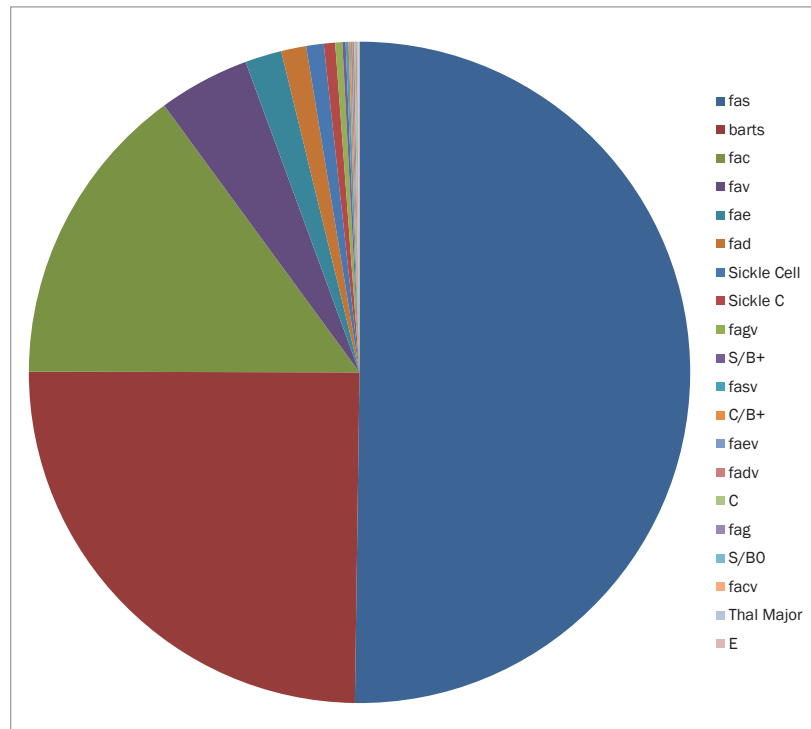

2 cases each: Baltimore J, D, D/E, S/HPFH

1 case each: Baltimore N, HPFH, Thal Intermedia/HPFH, Thal + C trait, C/Camden, C/Korle Bu, E/B+, O Arab, S/Baltimore, S/O Arab, Unidentified Variant

10 Years of Confirmed Data for Hemoglobinopathy Disease in State 3: 1999-2009

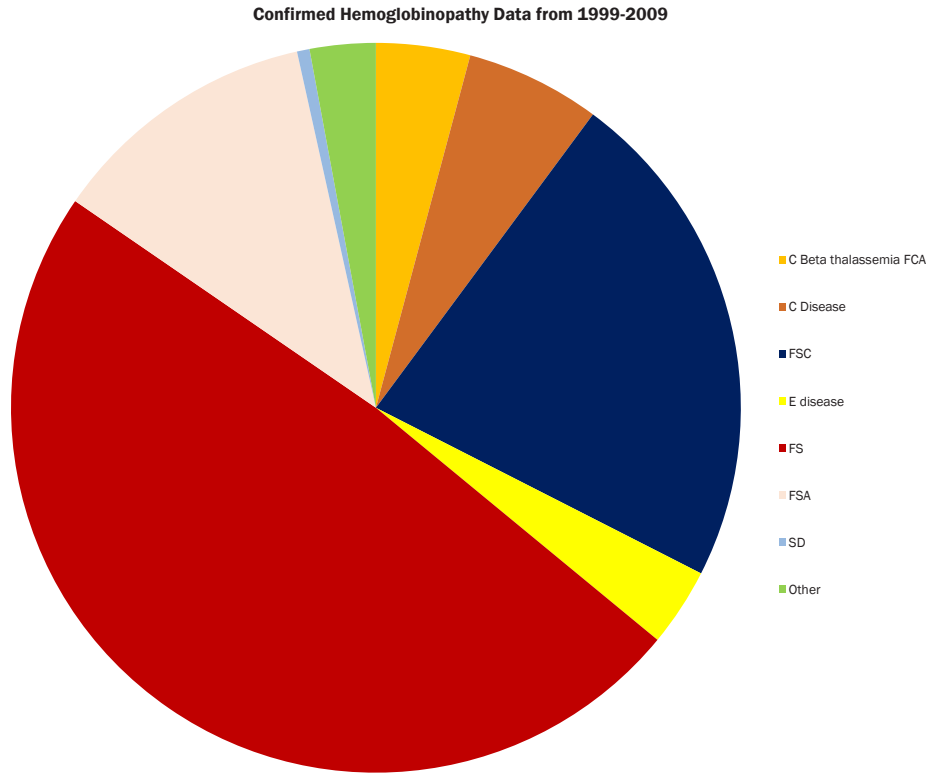

Top 20 Hemoglobinopathies in State 4: 2008-2012

*Rank	Description	Phenotype Nomenclature
1	Normal hemoglobin.	FA or AF
2	Hb S trait.	FAS or AFS
3	Hb E trait.	FAE or AFE
4	Moderate Bart's. 2 gene alpha thalassemia.	FAA+Bart's or FAB2
5	Hb variant trait.	FA+Var or FAV or AFV
6	Hb C trait.	FAC or AFC
7	Hb D trait.	FAD or AFD
8	Hb constant spring with low to moderate Bart's.	FA+CS+Bart's or FAXB1 or FAXB2
9	Hb E disease. Homozygous Hb E.	FEE or FE
10	Hb E trait with moderate Bart's. 2 gene alpha thalassemia.	FAE+Bart's or FAEB2
11	High Bart's. Hb H disease. 3 gene alpha thalassemia.	FAA+High Bart's or FAB3
12	Hb S disease. Sickle cell disease. Homozygous Hb S.	FSS or FS
13	Hb S trait with moderate Bart's.	FAS+Bart's or FASB2
14	Hb E trait with constant spring. 2 gene alpha thalassemia.	FAE+CS+Bart's
15	Hb sickle C disease.	FSC
16	E beta zero thalassemia. Heterozygous Hb E.	FE-
17	Hb E trait plus an uncommon variant.	FAE+Var or FAEV
18	Hb SE disease. Compound heterozygous Hb SE	FSE
19	Hb C disease. Homozygous Hb C.	FCC
20	S beta zero thalassemia. Heterozygous Hb S.	FS-

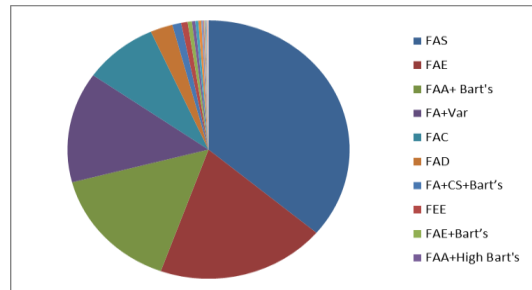

*Ranked data combined Hbs from 2008 to 2012

Appendix C: State 1 DNA Screening Algorithm

Hemoglobinopathy Result	Forward to PCR (DNA)
F,A	N
F,A,S	Y (T)
F,A,C	Y (T)
F,A,D	Y (T)
F,A,Other	N
F,S	Y
F,C	Y
F,S,C	Y
F,A,E	Y (T)
F,E	Y
A,F	N
A,S,F	Y (T)
A,C,F	Y (T)
S,C,F	Y
S,F	Y
C,F	Y
E,F	Y
A,A	N
A,S	Y (T)
A,C	Y (T)
A,E	Y (T)
A,D	Y (T)
S,S	Y
S,C	Y
C,C	Y
E,E	Y
F,D	Y
F Only Detected	Y
F,S (A Questionable)	Y
F,C (A Questionable)	Y
F,E (A Questionable)	Y
F,A,S,Other	Y (T)
A,E,F	Y (T)
A,D,F	Y (T)
A,Other	N
A,F,Other	N
A,F,S	Y
A,F,C	Y
F,Other	Y
F,A,Barts	N
F,A,S,Barts	Y (T)
F,A,C,Barts	Y (T)
F,A,E,Barts	Y (T)
F,A,D,Barts	Y (T)
F,A,O-Arab	Y (T)
F,A,elevated Barts	N
F,S,Barts	Y
F,S,A	Y
F,C,A	Y
F,S,C,Barts	Y
F,A,Other,Barts	N
A,F,Other,Barts	N
A,F,S,Barts	Y
A,F,D	Y
A,G	N
F,G	N
A,G,F	N
F,A,G,Barts	N
A,F,G	N
F,A,C,Other	Y (T)
S,A	Y
C,A	Y
F,A,G	N

NOTE: Y (T) indicates that this result is sent for DNA testing only if demographic information shows the baby has been transfused.

NOTE: Y (T) indicates that this result is sent for DNA testing only if demographic information shows the baby has been transfused.

Appendix D: Hemoglobinopathy Screening Algorithm for State 1

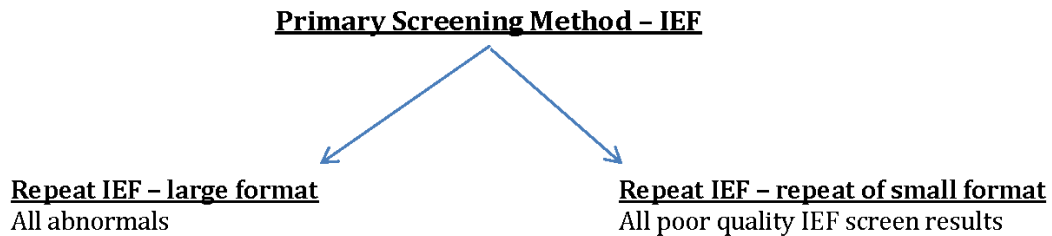

HPLC

- All disease or questionable Hb A specimens¹.
- Specimens with HbS, HbC, HbD, or HbE trait combined with beta thalassemia.
- All specimens with HbE.
- Specimens that are HbS, HbC, or HbE trait and have other Hb variants.
- Specimens that failed twice to measure with the IEF controls on the retest gel².
- All specimens with HbS.

Hb Barts and unidentified Hb variants are not run on HPLC.

DNA confirmation

- All diseases (no HbA).
- Specimens with HbS, HbC, HbD, or HbE trait combined with beta thalassemia³.
- Specimens with HbS, HbC, HbD, HbE or HbO-Arab trait and indicate transfusion.

1. HbA can be very faint and questionably visible on IEF, HPLC can be used to help determine if HbA is truly present.
2. Specimens may fail on IEF due to distortion of bands, specimens running together, or bands not being well focused.
3. Beta thalassemia is determined on IEF by comparing band intensities of HbA and the variant band. HbA will appear reduced in quantity when compared to the variant band.

Appendix E: Hemoglobinopathy Screening Algorithm for State 1 – Older Children & Adults

Primary Screening Method – IEF



Repeat IEF – large format

All abnormal and poor quality IEF screen results



HPLC

- All specimens with HbS.

DNA confirmation

None – NBS specimens only.

Appendix F: State 1 Hemoglobinopathy Result Codes

Code	Result	Statement
1	F,A	Normal
02	F,A,S	Probable S Trait. Notify family of test results.
03	F,A,C	Probable C Trait. Notify family of test results.
04	F,A,D	Probable D Trait. Notify family of test results.
05	F,A,Other	Probable Unidentified Hb Variant Trait. Notify family of test results. Recommend consultation with pediatric hematologist.
05F	F,A,Other	Probable Unidentified Hb Variant Trait. Notify family of test results. Recommend consultation with pediatric hematologist.
05M	F,A,Other	Probable Unidentified Hb Variant Trait. Notify family of test results. Recommend consultation with pediatric hematologist.
05S	F,A,Other	Probable Unidentified Hb Variant Trait. Notify family of test results. Recommend consultation with pediatric hematologist.
06	F,S	Probable SS Disease. Refer to pediatric hematologist. DNA report to follow.
07	F,C	Probable CC Disease. Refer to pediatric hematologist. DNA report to follow.
08	F,S,C	Probable SC Disease. Refer to pediatric hematologist. DNA report to follow.
09	F,A,E	Probable E Trait. Notify family of test results.
10	F,E	Probable EE Disease. Refer to pediatric hematologist. DNA report to follow.
11	A,F	Probable Normal. If result is due to transfusion, repeat in one to three months post transfusion.
12	A,S,F	Probable S Trait. Notify family of test results.
13	A,C,F	Probable C Trait. Notify family of test results.
14	S,C,F	Probable SC Disease. Refer to pediatric hematologist. DNA report to follow.
15	S,F	Probable SS Disease. Refer to pediatric hematologist. DNA report to follow.
16	C,F	Probable CC Disease. Refer to pediatric hematologist. DNA report to follow.
17	E,F	Probable EE Disease. Refer to pediatric hematologist. DNA report to follow.
18	A,A	Probable Normal. If result is due to transfusion, repeat in one to three months post transfusion.
19	A,S	Probable S Trait. Notify family of test results.
20	A,C	Probable C Trait. Notify family of test results.
21	A,E	Probable E Trait. Notify family of test results.
22	A,D	Probable D Trait. Notify family of test results.

Code	Result	Statement
23	S,S	Probable SS Disease. Refer to pediatric hematologist. DNA report to follow.
24	S,C	Probable SC Disease. Refer to pediatric hematologist. DNA report to follow.
25	C,C	Probable CC Disease. Refer to pediatric hematologist. DNA report to follow.
26	E,E	Probable EE Disease. Refer to pediatric hematologist. DNA report to follow.
27	F,D	Probable DD Disease. Refer to pediatric hematologist. DNA report to follow.
28	F Only Detected	Possible Beta Thalassemia Major. Refer to pediatric hematologist. DNA report to follow.
29	F,S (A Questionable)	Possible Sickle Cell or Sickle Beta Thalassemia Disease. Refer to pediatric hematologist. DNA report to follow.
30	F,C (A Questionable)	Possible CC or Hemoglobin C/Beta Thalassemia Disease. Refer to pediatric hematologist. DNA report to follow.
31	F,E (A Questionable)	Possible EE or Hemoglobin E/Beta Thalassemia Disease. Refer to pediatric hematologist. DNA report to follow.
32	F,A,S,Other	Probable S Trait and Unidentified Hb Variant. Notify family of test results. Consult with pediatric hematologist.
33	A,E,F	Probable E Trait. Notify family of test results.
34	A,D,F	Probable D Trait. Notify family of test results.
35	A,Other	Probable Unidentified Hb Variant Trait. Notify family of test results. Recommend consultation with pediatric hematologist.
36	A,F,Other	Probable Unidentified Hb Variant Trait. Notify family of test results. Recommend consultation with pediatric hematologist.
36F	A,F,Other	Probable Unidentified Hb Variant Trait. Notify family of test results. Recommend consultation with pediatric hematologist.
36M	A,F,Other	Probable Unidentified Hb Variant Trait. Notify family of test results. Recommend consultation with pediatric hematologist.
36S	A,F,Other	Probable Unidentified Hb Variant Trait. Notify family of test results. Recommend consultation with pediatric hematologist.
37	A,F,S	Probable S Trait. Notify family of test results. DNA report to follow.
38	A,F,C	Probable C Trait. Notify family of test results. DNA report to follow.
39	F,Other	Probable Unidentified Hb Variant. Refer to pediatric hematologist. DNA report to follow.
40	F,A,Barts	Probable Alpha Thalassemia Trait. Notify family of test results.
41	F,A,S,Barts	Probable S Trait and Alpha Thalassemia Trait. Notify family of test results.
42	F,A,C,Barts	Probable C Trait and Alpha Thalassemia Trait. Notify family of test results.
43	F,A,E,Barts	Probable E Trait and Alpha Thalassemia Trait. Notify family of test results.
44	F,A,D,Barts	Probable D Trait and Alpha Thalassemia Trait. Notify family of test results.
45	F,A,O-Arab	Probable O-Arab Trait. Notify family of test results.

Code	Result	Statement
46	F,A,elevated Barts	Probable H Disease. Refer to a pediatric hematologist.
47	F,S,Barts	Probable SS Disease and Alpha Thalassemia Trait. Refer to pediatric hematologist. DNA report to follow.
48	F,S,A	Probable Sickle Beta Thalassemia Disease. Refer to pediatric hematologist. DNA report to follow.
49	F,C,A	Probable Hemoglobin C/Beta Thalassemia Disease. Refer to pediatric hematologist. DNA report to follow.
50	F,S,C,Barts	Probable SC Disease and Alpha Thalassemia Trait. Refer to pediatric hematologist. DNA report to follow.
51	F,A,Other,Barts	Probable Unidentified Hb Variant Trait and Alpha Thalassemia Trait. Notify family of test results. Consult with pediatric hematologist.
52	A,F,Other,Barts	Probable Unidentified Hb Variant Trait and Alpha Thalassemia Trait. Notify family of test results. Consult with pediatric hematologist.
53	A,F,S,Barts	Probable S Trait and Alpha Thalassemia Trait. Notify family of test results. DNA report to follow.
54	A,F,D	Probable D Trait. Notify family of test results. DNA report to follow.
55	A,G	Probable G Trait. Notify family of test results.
56	F,G	Probable GG Disease. Refer to pediatric hematologist.
57	A,G,F	Probable G Trait. Notify family of test results.
58	F,A,G,Barts	Probable G Trait and Alpha Thalassemia Trait. Notify family of test results. Consult with pediatric hematologist.
59	A,F,G	Probable G Trait. Notify family of test results.
60	F,A,C,Other	Probable C Trait and Unidentified Hb Variant Trait. Consult with pediatric hematologist. Notify family of test results.
62	S,A	Probable Sickle Beta Thalassemia Disease. Refer to pediatric hematologist. DNA report to follow.
63	C,A	Probable Hemoglobin C/Beta Thalassemia Disease. Refer to pediatric hematologist. DNA report to follow.
64	F,A,G	Probable G Trait. Notify family of test results.
65	F,A,S,G	Probable S Trait and G Trait. Notify family of test results. Consult with pediatric hematologist.
66	F,A,S,G,Barts	Probable S Trait, G Trait, and Alpha Thalassemia Trait. Notify family of test results. Consult with pediatric hematologist.
67	F,A,C,G	Probable C Trait and G Trait. Notify family of test results. Consult with pediatric hematologist.
68	F,A,C,G,Barts	Probable C Trait, G Trait, and Alpha Thalassemia Trait. Notify family of test results. Consult with pediatric hematologist.
69	F,E,Barts	Probable EE Disease and Alpha Thalassemia Trait. Refer to pediatric hematologist. DNA report to follow.
70	F,C,Barts	Probable CC Disease and Alpha Thalassemia Trait. Refer to pediatric hematologist. DNA report to follow.
71	F,S,D	Probable SD Disease. Refer to pediatric hematologist. DNA report to follow.
72	F,C,E	Probable CE Disease. Refer to pediatric hematologist. DNA report to follow.
73	F,S,E	Probable SE Disease. Refer to pediatric hematologist. DNA report to follow.

Code	Result	Statement
96	Abnormal	Refer to mailer for free text result.(Case Management - No) (PCR - Yes)
97	Abnormal	Refer to mailer for free text result.(Case Management - No) (PCR - No)
98	Abnormal	Refer to mailer for free text result.(Case Management - Yes) (PCR - No)
99	Abnormal	Refer to mailer for free text result.(Case Management - Yes) (PCR - Yes)
100	Abnormal	Refer to mailer for free text result. (S trait notification - Yes) (PCR - No)
101	Abnormal	Refer to mailer for free text result. (S trait notification - Yes) (PCR - Yes)
BM	Retest	Bad Measure
LA	Retest	Light A
NF	Retest	Not Focused
CT	Retest	Contaminated
QC	Retest	Controls Failed
DB	Retest	Distorted Bands
RN	Retest	Runs
GQ	Retest	Gel Quality Not Acceptable
GB	Retest	Gel Burned
NS	Retest	No Specimen
LS	Retest	Light Specimen
SLA	RFS	Repeat from Screen-Light A
SNF	RFS	Repeat from Screen - Not Focused
SCT	RFS	Repeat from Screen - Contaminated
SQC	RFS	Repeat from Screen - Controls Failed
SDB	RFS	Repeat from Screen - Distorted Band
SRN	RFS	Repeat from Screen - Runs
SGQ	RFS	Repeat from Screen - Gel Quality Not Acceptable
SGB	RFS	Repeat from Screen - Gel Burned
SLS	RFS	Repeat from Screen - Light Specimen

Appendix G: State 2 Hemoglobin Coding System

Sickle Cell Mnemonics

Mnemonic	Description
ACFF	Hemoglobinopathy: AFC or AC - Possible hemoglobin C trait
ACVFF	HGB: ACVF or ACV - Possible hemoglobin C trait & hemoglobin variant
ADFF	HGB: ADF or FAD - Possible hemoglobin D trait
ADFVMF	Hemoglobinopathy: ADFV or FADV - Possible hemoglobin D trait and hemoglobin variant
AEFF	Hemoglobinopathy: AEF or FAE - Possible hemoglobin E trait
AEVFF	Hemoglobinopathy: AEV or FAEV - Possible hemoglobin E trait and hemoglobin variant
AFBART	Hemoglobinopathy: AF - Hemoglobin A & F with possible Bart's hemoglobin - Consultation strongly recommended
AFFAST	Hemoglobinopathy: FA - Hemoglobin F & A with Fast Moving hemoglobin - Consultation strongly recommended
AFNOTB	
AFOLD	
AGFF	Hemoglobinopathy: AGF or FAG - Possible hemoglobin G trait
AGFVMF	Hemoglobinopathy: AGFV or FAGV - Possible hemoglobin G trait and hemoglobin variant
ASFF	Hemoglobinopathy: AFS or AS - Possible sickle cell trait
ASVFF	Hemoglobinopathy: ASVF or ASV - Possible sickle cell trait & hemoglobin variant
AVFF	Hemoglobinopathy: AFV or AV - Possible hemoglobin variant
BARTS	Hemoglobinopathy: FA - Hemoglobin F & A with possible Bart's hemoglobin - Consultation strongly recommended
F50A1F	Hemoglobinopathy: Hb F above 50%, Hb A less than 1% - Consultation strongly recommended
F50A1I	Hemoglobinopathy: Hb F above 50%, Hb A less than 1% Immediate consultation and submit repeat specimen at 4 weeks of age
F50A20	Hemoglobinopathy: FA - Hb F above 50%, Hb A less than 20% with fast moving Hb - Consultation strongly recommended
FA	NORMAL
FACI	Hemoglobinopathy: FAC - Possible hemoglobin C trait - Submit repeat specimen by 6 months of age
FACM	Hemoglobinopathy: FAC - Possible hemoglobin C trait
FACVI	Hemoglobinopathy: FACV - Possible hemoglobin C trait & hemoglobin variant - Submit repeat specimen by 6 months of age
FADI	Hemoglobinopathy: FAD - Possible hemoglobin D trait - Submit repeat specimen by 6 months of age
FADV	Hemoglobinopathy: FADV - Possible hemoglobin D trait and hemoglobin variant
FADVI	Hemoglobinopathy: FADV - Possible hemoglobin D trait & variant - Submit repeat specimen by 6 months of age
FAEI	Hemoglobinopathy: FAE/A2 - Possible hemoglobin E trait - Submit repeat specimen by 6 months of age

Sickle Cell Mnemonics

Mnemonic	Description
FAEVI	Hemoglobinopathy: FAE/A2 V - Possible hemoglobin E trait and HGB variant - Submit repeat specimen by 6 months of age
FAGI	Hemoglobinopathy: FAG - Possible hemoglobin G trait - Submit repeat specimen by 6 months of age
FAGVI	Hemoglobinopathy: FAGV - Possible hemoglobin G trait and Hb variant - Submit repeat specimen by 6 months of age
FAPERF	Hemoglobinopathy: FA - Possible hereditary persistence of fetal hemoglobin - Consultation strongly recommended
FASI	Hemoglobinopathy: FAS - Possible sickle cell trait - Submit repeat specimen by 6 months of age
FASM	Hemoglobinopathy: FAS - Possible sickle cell trait
FAST	Hemoglobinopathy: FA - Hemoglobin F & A with Fast Moving hemoglobin - Consultation strongly recommended
FASVI	Hemoglobinopathy: FASV - Possible sickle cell trait & hemoglobin variant - Submit repeat specimen by 6 months of age
FAVI	Hemoglobinopathy: FAV - Possible hemoglobin variant - Submit repeat specimen by 6 months of age
FAVM	Hemoglobinopathy: FAV - Possible hemoglobin V trait
FCAF	Hemoglobinopathy: FCA - Possible C beta thalassemia - Consultation strongly recommended
FCAI	Hemoglobinopathy: FCA - Possible C beta thalassemia - Immediate consultation and submit repeat specimen by 4 weeks of age
FCF	Hemoglobinopathy: FC or CF - Possible hemoglobin C - Consultation strongly recommended
FCI	Hemoglobinopathy: FC - Possible hemoglobin C - immediate consultation and submit repeat specimen at 4 weeks of age
FCVF	Hemoglobinopathy: FCV or CVF - Possible hemoglobin C and hemoglobin variant - Consultation strongly recommended
FCVI	Hemoglobinopathy: FCV - Possible hemoglobin C and variant - Immediate consultation and submit repeat specimen at 4 weeks of age
FDEF	Hemoglobinopathy: FDE or DEF - Possible hemoglobin D and E - Consultation strongly recommended
FDEI	Hemoglobinopathy: FDE - Possible hemoglobin D and E - Immediate consultation and submit repeat specimen at 4 weeks of age
FDF	Hemoglobinopathy: FD - Possible hemoglobin D - Consultation strongly recommended
FDI	Hemoglobinopathy: FD - Possible hemoglobin D - Immediate consultation and submit repeat specimen at 4 weeks of age
FDVF	Hemoglobinopathy: FDV or DVF - Possible hemoglobin D and hemoglobin variant - Consultation strongly recommended
FDVI	Hemoglobinopathy: FDV - Possible hemoglobin D and hemoglobin variant - Immediate consultation and submit repeat specimen at 4 weeks of age
FEF	Hemoglobinopathy: FE/A2 or E/A2 - Possible hemoglobin E - Consultation strongly recommended
FEI	Hemoglobinopathy: FE/A2 - Possible hemoglobin FE/A2 - Immediate consultation & submit repeat specimen at 4 weeks of age
FF	Hemoglobinopathy: F - Possible hemoglobin F - Consultation strongly recommended
FGF	Hemoglobinopathy: FG - Possible hemoglobin G - Consultation strongly recommended
FGI	Hemoglobinopathy: FG - Possible hemoglobin G - Immediate consultation and submit repeat specimen at 4 weeks of age
FI	Hemoglobinopathy: F - Possible hemoglobin F - Immediate consultation and submit repeat specimen at 4 weeks of age
FSAF	Hemoglobinopathy: FSA - Possible S beta thalassemia - Consultation strongly recommended
FSAI	Hemoglobinopathy: FSA - Possible S beta thalassemia - Immediate consultation and submit repeat specimen at 4 weeks of age

Sickle Cell Mnemonics

Mnemonic	Description
FSCF	Hemoglobinopathy: FSC or SC - Possible hemoglobin S and C - Consultation strongly recommended
FSCI	Hemoglobinopathy: FSC - Possible hemoglobin S and C - Immediate consultation and submit repeat specimen at 4 weeks of age
FSCVF	Hemoglobinopathy: FSCV - Possible hemoglobin S and C variant - Consultation recommended
FSCVI	Hemoglobinopathy: FSCV - Possible hemoglobin S & C variant - Immediate consultation and submit repeat specimen at 4 weeks of age
FSEF	Hemoglobinopathy: FSE or SEF - Possible hemoglobin S and E - Consultation strongly recommended
FSEI	Hemoglobinopathy: FSE - Possible hemoglobin S and E - Immediate consultation and submit repeat specimen at 4 weeks of age
FSF	Hemoglobinopathy: FS or SF - Possible sickle cell disease - Consultation strongly recommended
FSI	Hemoglobinopathy: FS - Possible sickle cell disease - Immediate consultation and submit repeat specimen at 4 weeks of age
FSVBTf	Hemoglobinopathy: Possible FSV or FSV - beta thalassemia - Consultation strongly recommended
FSVBTI	Hemoglobinopathy: Possible FSV or FSV - beta thalassemia - Immediate consultation and submit repeat specimen at 4 weeks of age
FSVF	Hemoglobinopathy: FSV or SV - Possible sickle cell disease and hemoglobin variant - Consultation strongly recommended
FSVI	Hemoglobinopathy: FSV - Possible sickle cell disease & HGB variant - Immediate consultation and submit repeat specimen at 4 weeks of age
FVF	Hemoglobinopathy: FV or V - Possible hemoglobin variant - Consultation strongly recommended
FVI	Hemoglobinopathy: FV - Possible hemoglobin variant - Immediate consultation and submit repeat specimen at 4 weeks of age
INCELLU	Hemoglobinopathy: Unsatisfactory - Incomplete elution from blotter - Submit repeat specimen within 2 days
INCONS	Hemoglobinopathy: Inconsistent results - Submit repeat specimen within 2 days
INDFAS	Hemoglobinopathy: Non-definitive AFS - Submit repeat specimen within 120 days after last transfusion
INDPOS	Hemoglobinopathy: AF or A - Indeterminate results due to possible blood transfusion(s), submit repeat specimen within 120 days after last transfusion
NDFR4M	Hemoglobinopathy: Non-definitive results - Submit repeat specimen at 4 weeks of age
NDFR6M	Hemoglobinopathy: Non-definitive results - Submit repeat specimen at 6 months of age
NOFABO	Hemoglobinopathies: Bart's hemoglobin only, no F or A hemoglobin present. Possible Hydrops Fetalis - Consultation recommended
NORPT	Hemoglobinopathy: No repeat required
PRE	Hemoglobinopathy: Premature infant - non-definitive results - Submit repeat specimen at 4 weeks of age
PREFAS	Hemoglobinopathy: Premature infant - non definitive FAS - Submit repeat specimen at 4 weeks of age
QNS	Hemoglobinopathy: Quantity insufficient - Submit repeat specimen within 2 days
RWAL	Hemoglobinopathy: (null)
SCFBTF	Hemoglobinopathy: Possible SCF or SCF - beta thalassemia - Consultation strongly recommended
TRAN	Hemoglobinopathy: Indeterminate results due to blood transfusion(s) - Submit repeat specimen 120 days after last transfusion
TRANNP	Hemoglobinopathy results assume that no transfusion was performed because transfusion information was not provided (NP)
U1	Hemoglobinopathy: Specimen not on Whatman 903 paper - Repeat within 2 days

Sickle Cell Mnemonics

Mnemonic	Description
U10	Hemoglobinopathy: Specimen not allowed to dry thoroughly - Repeat within 2 days
U11	Hemoglobinopathy: Conflicting information - Specimen identity uncertain - Repeat within 2 days
U12	Hemoglobinopathy: Incomplete saturation of filter- Repeat within 2 days
U14	Hemoglobinopathy: Expired filter - Repeat within 2 days
U2	Hemoglobinopathy: Specimen not attached to form - Repeat within 2 days
U3	Hemoglobinopathy: Quantity insufficient - Submit repeat specimen within 2 days
U4	Hemoglobinopathy: Contaminated or diluted - Repeat filter within 2 days
U5	Hemoglobinopathy: Oversaturated specimen - Repeat filter within 2 days
U6	Hemoglobinopathy: Blood clotted or caked - Repeat filter within 2 days
U7	Hemoglobinopathy: Filter paper torn or scratched - Repeat within 2 days
U8	Hemoglobinopathy: > 14 days from collection date - Repeat within 2 days
U9	Hemoglobinopathy: Filter paper distorted - Repeat filter within 2 days
FAOI	Hemoglobinopathy: Possible hemoglobin O trait - Submit repeat specimen by 6 months of age
FAOM	Hemoglobinopathy: Possible hemoglobin C trait
AOFF	Hemoglobinopathy: AFO & AO - Possible hemoglobin O trait
FAOVI	Hemoglobinopathy: Possible hemoglobin O trait & hemoglobin variant - Submit repeat specimen by 6 months of age
AOFVF	Hemoglobinopathy: AOVF & AOV - Possible hemoglobin O trait & hemoglobin variant

Appendix H: State 3 Hg Reporting Algorithm

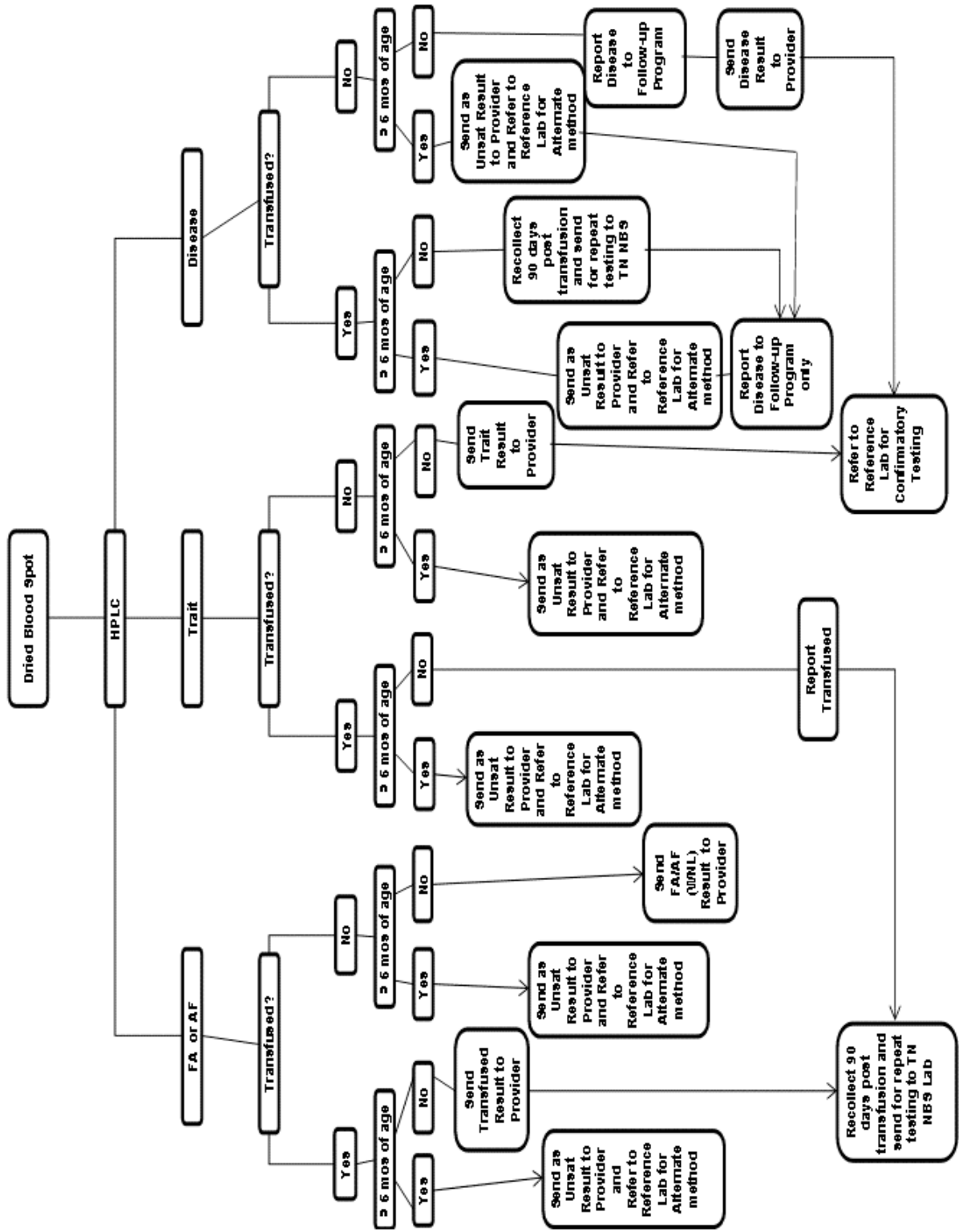

Appendix I: State 4 Hb Screening Algorithm

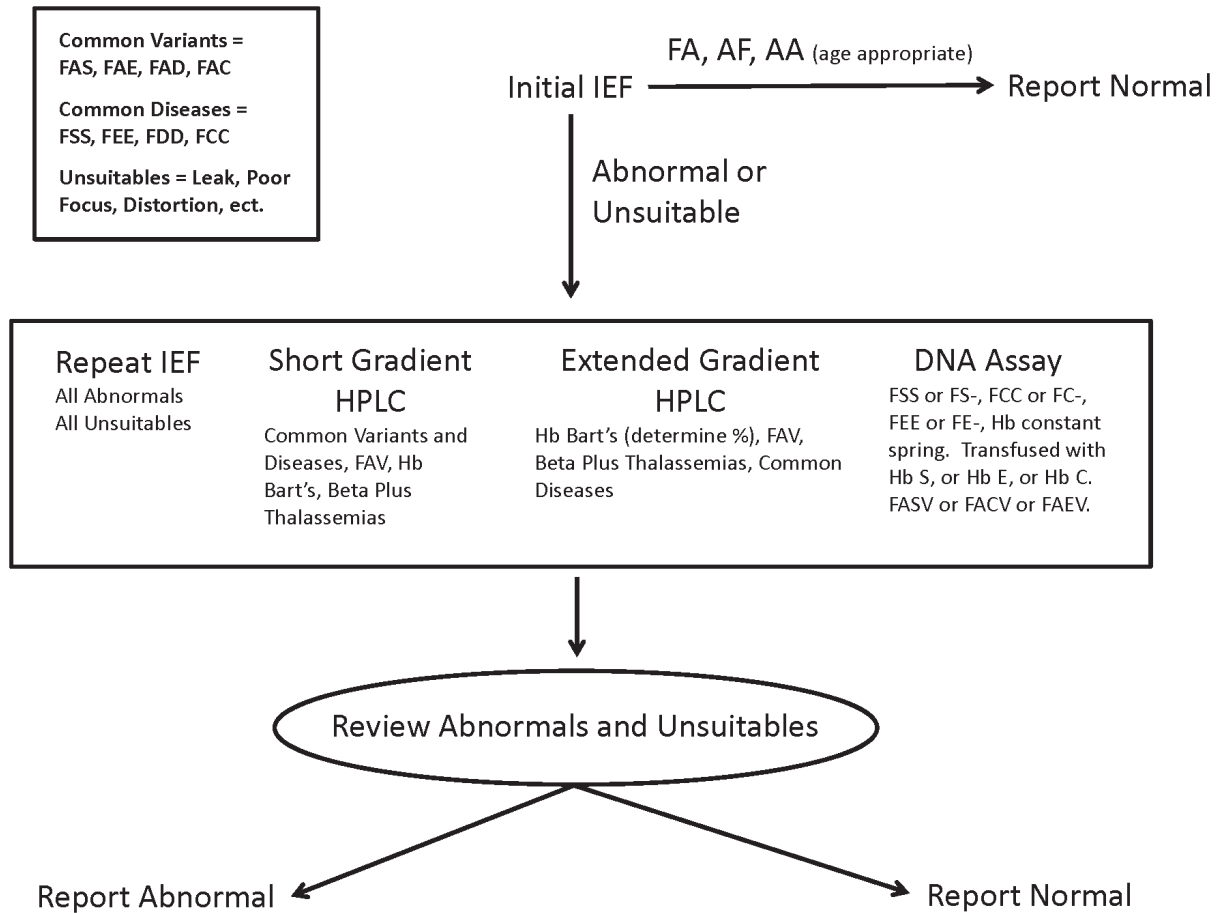

Appendix J: State 4 Hb Result Codes

Result Code	Description (brief)
AA	Normal Finding
AA-PB	Normal Finding (previous specimen with moderate Bart's)
AAR	Hb A (Age inappropriate, no suitable previous specimen)
AAY	Hb A (Age inappropriate, suitable previous specimen)
AC	Hb C trait
ACF	Hb C trait, Hb F
AD	Hb D trait
ADF	Hb D trait, Hb F
AE	Hb E trait
AEF	Hb E trait, Hb F
AEFB2	Hb E trait, moderate Bart's
AEFVB2	Hb A, Hb E, Hb F, Hb variant, moderate Bart's
AEFXB2	Hb E trait, Hb F, Hb constant spring, moderate Bart's
AF	Normal Finding
AFB2	Moderate Bart's
AFB3	High Bart's (possible Hb H Disease)
AFC	Hb C trait
AFCB2	Hb C trait, moderate Bart's
AFD	Hb D trait
AFE	Hb E trait
AFEB2	Hb E Trait, Hb F, moderate Bart's
AFEXB2	Hb E trait, Hb F, Hb constant spring, moderate Bart's
AF-PB	Normal Finding (previous Hb Bart's)
AFR	Hb A, Hb F (age inappropriate, no suitable previous specimen)
AFS	Hb S trait, Hb F
AFSB2	Hb S trait, Hb F, moderate Bart's
AFV	Hb variant trait, Hb F
AFVB2	Hb variant trait, Hb F, moderate Bart's
AFXB2	Hb constant spring, Hb F, moderate Bart's
AFXB3	High Bart's, Hb constant spring (possible Hb H Disease)
AFY	Hb A, Hb F (age inappropriate, suitable previous specimen)
AMBD	Ambiguous degradation (suitable previous specimen)
AMBDR	Ambiguous degradation (no suitable previous specimen)
AS	Hb S trait
ASF	Hb S trait, Hb F
ASFB2	Hb S trait, Hb F, moderate Bart's
AV	Hb variant trait
AVF	Hb variant trait, Hb F

Result Code	Description (brief)
AVFB2	Hb variant trait, Hb F, moderate Bart's
CC	Hb C only (possible Hb C disease)
CCF	Hb C, Hb F (possible Hb C disease)
CE	Hb C, Hb E (possible CE disease)
CEF	Hb C, Hb E, Hb F (possible CE disease)
C-F	Hb C, Hb F (possible C beta zero thalassemia)
CS	Hb C, Hb S (possible sickle C disease)
CSF	Hb C, Hb S, Hb F (possible sickle C disease)
E-	Hb E only (possible E beta zero thalassemia)
EE	Hb E only (possible Hb E disease)
EEF	Hb E, Hb F (possible Hb E disease)
FA	Normal Finding
FAB2	Moderate Bart's
FAB3	High Bart's (possible Hb H disease)
FAB-PN	Moderate Bart's (previous normal specimen)
FAC	Hb C trait
FACB2	Hb C trait, moderate Bart's
FACV	Hb C trait, Hb variant
FAD	Hb D trait
FAE	Hb E trait
FAEB2	Hb E trait, moderate Hb Bart's
FAEB3	High Bart's, Hb E trait (possible Hb H disease)
FAEV	Hb E trait, Hb variant
FAEXB1	Hb E trait, Hb constant spring, low Bart's
FAEXB2	Hb E trait, Hb constant spring, moderate Bart's
FA-PB	Normal Finding - Previous Bart's
FAS	Hb S trait
FASB2	Hb S trait, moderate Bart's
FASV	Hb S trait, Hb variant
FASVB2	Hb S trait, Hb variant, moderate Bart's
FAV	Hb variant trait
FAVB2	Hb variant, moderate Bart's
FAXB1	Hb constant spring, low Bart's
FAXB2	Hb constant spring, moderate Bart's
FAXB3	High Bart's, Hb constant spring (possible Hb H Disease)
FC-	Hb C only (possible C beta zero thalassemia)
FC2A	Hb C trait (possible C beta plus thalassemia)
FCC	Hb C only (possible Hb C disease)
FCE	Hb C, Hb E (possible CE disease)
FCS	Hb C, Hb S (possible sickle C disease)
FD2A	Hb D trait (possible D beta plus thalassemia)

Result Code	Description (brief)
FDD	Hb D only (possible Hb D disease)
FE-	Hb E only (possible E beta zero thalassemia)
FEA	Hb E trait (possible E beta plus thalassemia)
FEE	Hb E only (possible Hb E disease)
FEEB2	Hb E only, moderate Bart's
FEEB3	High Bart's, Hb E only (possible Hb H disease and Hb E disease)
FS-	Hb F, Hb S (possible S beta zero thalassemia)
FS2A	Hb S trait (possible S beta plus thalassemia)
FSC	Hb F, Hb S, Hb C (possible sickle C disease)
FSE	Hb F, Hb S, Hb E (possible SE disease)
FSS	Hb F, Hb S (possible sickle cell disease)
FSSB2	Hb F, Hb S, moderate Bart's (possible sickle cell disease)
FSSB3	Hb F, Hb S, High Bart's (possible sickle cell and Hb H disease)
FSV	Hb F, Hb S, Hb variant (possible SV disease)
SC	Hb S, Hb C (possible sickle C disease)
SCF	Hb S, Hb C, Hb F (possible sickle C disease)
SEF	Hb S, Hb E, Hb F (possible SE disease)
SF-	Hb S, Hb F (possible S beta zero thalassemia)
SF2A	Hb S trait (possible S beta plus thalassemia)
SS	Hb S only (possible sickle cell disease)
SSF	Hb S, Hb F (possible sickle cell disease)
TO-O	Unsuitable, too old for Hb testing (previous suitable specimen)
TO-OR	Unsuitable, too old for Hb testing (no previous suitable specimen)
UT	Unsuitable transfused (previous suitable specimen)
UT+B	Unsuitable transfused, moderate Bart's
UT+C	Unsuitable transfused, Hb C trait
UT+E	Unsuitable transfused, Hb E trait
UT+S	Unsuitable transfused, Hb S trait
UT+VAR	Unsuitable transfused, Hb variant trait
UTR	Unsuitable transfused (no previous suitable specimen)
XXX	No code mapped for this phenotype (custom mailer note)

Association of Public Health Laboratories

The Association of Public Health Laboratories (APHL) is a national nonprofit dedicated to working with members to strengthen laboratories with a public health mandate. By promoting effective programs and public policy, APHL strives to provide public health laboratories with the resources and infrastructure needed to protect the health of US residents and to prevent and control disease globally.



8515 Georgia Avenue, Suite 700
Silver Spring, MD 20910
Phone: 240.485.2745
Fax: 240.485.2700
Web: www.aphl.org