

# Best Practices for Dust Control in Coal Mining

Second Edition



Centers for Disease Control  
and Prevention  
National Institute for Occupational  
Safety and Health

**Information Circular 9532**

# **Best Practices for Dust Control in Coal Mining**

## **Second Edition**

Jay F. Colinet, Cara N. Halldin, Joseph Schall

DEPARTMENT OF HEALTH AND HUMAN SERVICES  
Centers for Disease Control and Prevention  
National Institute for Occupational Safety and Health  
Office of Mine Safety and Health Research  
Pittsburgh, PA • Spokane, WA

August 2021

**This document is in the public domain and may be freely copied or reprinted.**

## Disclaimer

Mention of any company or product does not constitute endorsement by the National Institute for Occupational Safety and Health (NIOSH). In addition, citations to websites external to NIOSH do not constitute NIOSH endorsement of the sponsoring organizations or their programs or products. Furthermore, NIOSH is not responsible for the content of these websites. All web addresses referenced in this document were accessible as of the publication date.

## Get More Information

Find NIOSH products and get answers to workplace safety and health questions:

1-800-CDC-INFO (1-800-232-4636) | TTY: 1-888-232-6348

CDC/NIOSH INFO: [cdc.gov/info](https://www.cdc.gov/info) | [cdc.gov/niosh](https://www.cdc.gov/niosh)

Monthly NIOSH eNews: [cdc.gov/niosh/eNews](https://www.cdc.gov/niosh/eNews)

## Suggested Citation

NIOSH [2021]. Best practices for dust control in coal mining, second edition. By Colinet JF, Halldin CN, Schall J. Pittsburgh PA: U.S. Department of Health and Human Services, Centers for Disease Control and Prevention, National Institute for Occupational Safety and Health, DHHS (NIOSH) Publication No. 2021-119, IC 9532. <https://doi.org/10.26616/NIOSH PUB2021119>

DOI: <https://doi.org/10.26616/NIOSH PUB2021119>

DHHS (NIOSH) Publication No. 2021-119

August 2021

Front photos by NIOSH. Rear photo by Shutterstock.  
All photos used by permission as credited.  
All illustrations by NIOSH unless otherwise noted.

# CONTENTS

CONTENTS.....	iii
LIST OF FIGURES .....	vii
LIST OF TABLES.....	xiii
ACRONYMS AND ABBREVIATIONS USED IN THIS REPORT .....	xiv
UNIT OF MEASURE ABBREVIATIONS USED IN THIS REPORT.....	xvi
ACKNOWLEDGMENTS .....	xvii
FIRST EDITION .....	xvii
SECOND EDITION .....	xvii
<b>INTRODUCTION.....</b>	<b>1</b>
References for Introduction .....	5
<b>CHAPTER 1: HEALTH EFFECTS OF OVEREXPOSURE TO RESPIRABLE COAL AND SILICA DUST.....</b>	<b>7</b>
Coal Workers’ Pneumoconiosis.....	7
Silicosis.....	12
Diagnosis and Treatment of Pneumoconioses .....	16
Faces of Black Lung Videos and Information Booklet .....	17
References for Chapter 1 .....	18
<b>CHAPTER 2: SAMPLING TO QUANTIFY RESPIRABLE DUST GENERATION .....</b>	<b>21</b>
Respirable Dust Samplers Used in Coal Mining .....	22
Gravimetric Sampler.....	22
Continuous Personal Dust Monitor.....	24
Light-scattering Real-time Dust Monitor.....	26
Field-based Silica Analysis.....	28
Sampling Strategies .....	31
References for Chapter 2 .....	37
<b>CHAPTER 3: CONTROLLING RESPIRABLE DUST ON LONGWALL MINING SECTIONS.....</b>	<b>40</b>
Primary Dust Controls .....	42
Ventilation.....	42
Water Sprays.....	42
Controlling Respirable Dust Liberation from Intake Roadways .....	47
Limiting Outby Support Activities During Production Shifts .....	48

Water Application .....	48
Hydroscopic Compounds and Surfactants .....	48
Controlling Respirable Dust from the Belt Entry .....	48
Maintaining the Belt .....	49
Wetting the Coal on the Belt.....	49
Belt Cleaning with Scrapers and Brushes.....	49
Wetting Dry Belts .....	51
Controlling Respirable Dust at the Stageloader-Crusher and in the Headgate Area .....	51
Fully Enclosing the Stageloader-Crusher .....	52
Wetting Coal in the Stageloader-Crusher .....	52
Using a Fan-powered Scrubber at the Stageloader .....	53
Using a Water-powered Scrubber at the Stageloader .....	54
Installing a Gob Curtain.....	55
Repositioning Shearer Operators During Cutout.....	56
Controlling Shearer-generated Dust .....	56
Face Ventilation .....	57
Drum-mounted Water Sprays .....	57
Bit Maintenance .....	58
Directional Water Spray Systems .....	58
Headgate Splitter Arm Positioning .....	62
Shearer Deflector Plates.....	63
Ranging Arm Crescent Sprays.....	64
Lump Breaker Sprays .....	64
Controlling Shield Dust .....	65
Top Canopy Sprays.....	66
Underside Canopy Sprays.....	66
Increased Air Quantity and Distanced Shield Movement.....	67
Unidirectional Cutting Sequence .....	67
Emerging Dust Control Technologies .....	68
Fan-powered Shearer Scrubber.....	68
Underside Shield Sprays .....	70
Foam .....	71
References for Chapter 3 .....	73

<b>CHAPTER 4: CONTROLLING RESPIRABLE DUST ON CONTINUOUS MINING SECTIONS.....</b>	<b>78</b>
Section Ventilation.....	80
Intake Air Dust Control .....	82
Exhausting Face Ventilation .....	83
Blowing Face Ventilation .....	84
Crosscut Breakthroughs .....	86
Continuous Miner Dust Control.....	87
Efficient Cutting.....	87
Water Sprays.....	89
Flooded-Bed Scrubbers.....	93
Wetting Agents .....	99
Roof Bolter Dust Control.....	100
Efficient Drilling and Dust Confinement.....	100
Dry Vacuum Dust Collector .....	102
Wet and Mist Drilling .....	106
Working Downwind of the Continuous Miner .....	106
Canopy Air Curtain.....	106
Shuttle Car Dust Control for Blowing Face Ventilation.....	108
Maintenance of Dust Controls .....	108
Emerging Control Technologies for Continuous Mining Sections.....	108
Self-cleaning Nozzles .....	108
Dry Scrubber.....	109
Wet Collector Box .....	110
Shuttle Car Canopy Air Curtain.....	111
References for Chapter 4 .....	113
<b>CHAPTER 5: CONTROLLING RESPIRABLE DUST AT SURFACE MINES .....</b>	<b>118</b>
Enclosed Cabs for Equipment Operators.....	120
Performance Measures.....	120
Cab Integrity .....	120
Filtration and Pressurization Systems.....	122
Filter Selection.....	125
Air Intake and Discharge Locations .....	126
Internal Dust Sources.....	126

Dust Control for Highwall Drills .....	127
Dry Dust Collection System .....	127
Wet Drilling .....	135
Haul Road Dust Control.....	137
Road Construction .....	137
Traffic Control .....	138
Water Application.....	139
Chemical Dust Suppressants.....	141
Dust Control at the Primary Dump .....	143
Enclosure of the Primary Dump .....	143
Water Sprays at the Primary Dump .....	145
Activation of Dust Controls .....	145
Stockpile and Preparation Plant Dust Control .....	146
References for Chapter 5 .....	147
<b>CHAPTER 6: REDUCING FLOAT COAL DUST DEPOSITION.....</b>	<b>152</b>
Float Dust Sampling .....	153
Institute of Occupational Medicine (IOM) Sampler .....	153
Float Dust Personal Dust Monitor .....	154
Float Dust Control Technologies .....	155
Return Entry Flooded Bed Scrubber.....	157
Water Sprays.....	158
Water Curtain on Longwall .....	160
Conveyor Belt Transfer Controls.....	161
References for Chapter 6 .....	163

## LIST OF FIGURES

Figure I.1. Hierarchy of controls approach for reducing workplace hazards .....	3
Figure 1.1. Whole lung sections of normal lung, simple CWP, and PMF.....	7
Figure 1.2. ILO Standard Radiographs demonstrating no pneumoconiosis, simple CWP category 2/2, and PMF category C .....	8
Figure 1.3. Percentage of examined underground coal miners with CWP Category 1 or greater by tenure in mining.....	9
Figure 1.4. Percentage of underground miners examined in the CWHSP that were found to have PMF.....	10
Figure 1.5. Percentage of miners filing for federal black lung benefits between 1970 and 2016 that were found to have PMF.....	11
Figure 1.6. Sections of freeze-dried human lungs with silicosis and PMF.....	14
Figure 1.7. Percentage of r-type opacities by region and decade from 1980 through 2018 .....	15
Figure 1.8. Covers of original Faces of Black Lung videos produced by NIOSH .....	17
Figure 2.1. Miner wearing gravimetric sampler and sampling system components .....	23
Figure 2.2. PDM3700 sampler, TEOM, and TEOM module removed from PDM.....	24
Figure 2.3. Information displayed on a PDM3700 .....	25
Figure 2.4. pDR 1000AN sampler and pDR operated with gravimetric samplers in an underground coal mine .....	27
Figure 2.5. Dust measurements obtained with the pDR near the shearer on a longwall face .....	28
Figure 2.6. Portable FTIR units used in NIOSH testing: Thermo Fisher, Perkin Elmer, Bruker Optics, and Agilent manufacturers .....	29
Figure 2.7. Four-piece cassette with filter contained within two center sections and being loaded into an FTIR instrument cradle.....	30
Figure 2.8. Comparison of results obtained with portable FTIR and P7 silica analysis techniques.....	31
Figure 2.9. Sampling locations used to isolate dust generated by a continuous miner and sampling package positioned in intake air to the miner .....	32
Figure 2.10. Mobile sampling used to quantify dust generated by the shearer as it completes a tailgate-to-headgate cut across the longwall face .....	33
Figure 2.11. NIOSH researcher conducting mobile sampling by tracking the shearer across the face while wearing gravimetric samplers and carrying a pDR and a stationary sampling package hung on shield 10 .....	33
Figure 2.12. Sampling package hung in cab on shuttle car .....	34



Figure 2.13. Graph illustrating dust concentrations for different segments of a shuttle car load-haul-dump cycle .....	35
Figure 2.14. Sampling locations around a surface drill and a gravimetric sampling package positioned near the drill table.....	36
Figure 3.1. Average respirable dust concentrations calculated from samples collected by MSHA inspectors from 2010 through 2019 .....	40
Figure 3.2. Percentage of MSHA inspector samples analyzed for quartz for the tailgate shearer operator and jacksetter that exceeded 5% quartz.....	41
Figure 3.3. Effect of water droplet size on particle impingement .....	43
Figure 3.4. Hollow cone spray nozzle and spray pattern .....	44
Figure 3.5. Full cone spray nozzle and spray pattern .....	44
Figure 3.6. Flat fan nozzle and spray pattern.....	45
Figure 3.7. Solid stream nozzle and spray pattern .....	45
Figure 3.8. Venturi spray with nozzle mounted in center.....	46
Figure 3.9. Air atomizing nozzle and flat spray pattern .....	46
Figure 3.10. Performance of four spray types for capturing airborne respirable dust .....	47
Figure 3.11. Typical locations of primary and secondary belt scrapers and a photo of a primary belt scraper installed.....	50
Figure 3.12. Secondary belt scrapers and a rotating brush .....	50
Figure 3.13. Water sprays and belt wiper, and schematic and photo of v-shaped belt plow used to remove material from the nonconveying side of the belt .....	51
Figure 3.14. Stageloader-crusher enclosed by mine operator and a new unit offered by a manufacturer .....	52
Figure 3.15. Illustration showing how coal flows from the face conveyor into the enclosed crusher and stageloader where water sprays wet the coal during transport.....	53
Figure 3.16. Fan-powered scrubbers with intakes at the crusher discharge and stageloader-to-belt transfer .....	54
Figure 3.17. High-pressure water-powered scrubber installed on top of crusher .....	54
Figure 3.18. Airflow leaking through shields into gob, and installation of a gob curtain to increase airflow down the face .....	55
Figure 3.19. Shearer operator’s dust exposure when positioned at the headgate drum and repositioned upwind during the cutout at the headgate.....	56
Figure 3.20. Dull shearer bit missing carbide insert .....	58
Figure 3.21. Shearer-clearer directional spray system on longwall shearer .....	59
Figure 3.22. Venturi sprays mounted on headgate splitter arm .....	60

Figure 3.23. Flat fan sprays mounted on walkway side of belting on the headgate splitter arm .....	60
Figure 3.24. Directional spray manifolds mounted on face side of shearer body as viewed from the headgate and tailgate sides of the shearer .....	61
Figure 3.25. Sprays mounted on tailgate end of shearer body and directed parallel to ranging arm .....	62
Figure 3.26. Illustrations of splitter arm in a lowered position during the head-to-tail pass and in a raised position during the tail-to-head pass .....	63
Figure 3.27. The use of deflector plates to enhance the effectiveness of directional water sprays .....	63
Figure 3.28. Crescent sprays mounted on shearer ranging arms .....	64
Figure 3.29. Photos illustrating dust confined near face as seen from the tailgate shearer operator's position on a tail-to-head pass and the headgate shearer operator's position on a head-to-tail pass.....	65
Figure 3.30. Line graph showing that higher dust levels were observed during the head-to-tail pass as a result of shield-generated dust.....	66
Figure 3.31. Shield sprays located on the underside of the canopy interacting with directional sprays on the shearer, allowing dust to move toward the walkway.....	67
Figure 3.32. Full-scale shearer model with added scrubber components shown in blue.....	69
Figure 3.33. Testing shearer scrubber in NIOSH full-scale longwall dust gallery with sampling locations shown on left and scrubber inlet on right .....	70
Figure 3.34. Testing in full-scale longwall gallery and sampling locations .....	71
Figure 3.35. Foam generator spraying onto roof and stand used to test dust reduction with three foaming agents.....	72
Figure 4.1. Photo showing approximately 18 inches of roof rock extracted as part of mining and line graph showing increased respirable dust generation when mining rock .....	78
Figure 4.2. Percentage of MSHA inspector dust samples analyzed for quartz from continuous miner and roof bolter operators that contained greater than 5% quartz .....	80
Figure 4.3. Single-split and double-split face ventilation for continuous mining sections.....	81
Figure 4.4. Schematic of exhaust face ventilation system showing desired operator positioning for cuts taken on the left and right side of the entry .....	83
Figure 4.5. Schematic of blowing face ventilation system showing desired operator positioning for cuts taken on the left and right side of the entry .....	85
Figure 4.6. Illustration and line graph demonstrating how crosscut breakthrough into ventilating air short-circuits intake air and results in increased CM operator dust levels .....	87
Figure 4.7. Illustration showing proper bit design, which can lower dust generation.....	88

Figure 4.8. Illustration of how respirable dust generation is reduced by under-cutting roof rock and then backing up to extract rock.....	88
Figure 4.9. Common spray locations on continuous miners.....	89
Figure 4.10. Wet head spray located behind cutting bit and system operating on a continuous miner underground .....	91
Figure 4.11. Comparing return dust concentrations with wet head spray systems to original spray systems used at five mines, with key operating conditions listed for each mine .....	92
Figure 4.12. Components and layout of a flooded-bed scrubber .....	93
Figure 4.13. Forty-layer flat filter panel with mesh material shown. Ten-layer and 30-layer pleated panels with backlighting to show relative difference in filter density .....	95
Figure 4.14. Respirable dust reduction and scrubber airflow with different-density filters .....	96
Figure 4.15. Cleaning scrubber filter panel and mist eliminator with a water spray .....	98
Figure 4.16. Hydrophobic coal floating on water and sinking with the addition of a wetting agent and a bar chart representing changes in airborne dust capture with wetting agents .....	99
Figure 4.17. New and worn tungsten carbide dust hog style bits, polycrystalline diamond dust hog bit, and shank-style bit .....	100
Figure 4.18. Components of drill bit sleeve, installed on a drill steel, and bit sleeve raised to roof .....	101
Figure 4.19. Components of a dry vacuum dust collection system .....	102
Figure 4.20. Methods to ensure dust collector performance.....	103
Figure 4.21. Dust dropping out of dust box, operator cleaning dust box by hand, and insert used to assist in cleaning of dust box .....	103
Figure 4.22. Dust collector bag, bag nozzle, and bag positioned in collector box and filled with dust .....	104
Figure 4.23. Schematic illustrating canopy air curtain components and operating principle and being tested at an underground mine .....	107
Figure 4.24. Canopy air curtains installed on roof bolters at two underground coal mines .....	107
Figure 4.25. Positioning of dry scrubber to provide filtered air to roof bolter operators and dry scrubber with cover raised to show filters .....	109
Figure 4.26. Wet collector box on roof bolter and wetted material in collector box .....	110
Figure 4.27. Canopy air curtain installed on underside of ram car canopy and showing how filtered air is blown down over operator's position, along with a dust sampling package located outside of cab .....	111
Figure 5.1. Layout of three-filter system for an enclosed cab field tested by NIOSH .....	122
Figure 5.2. Three-filter cab system with Q denoting air quantities, X and C denoting dust concentrations, and $\eta$ denoting filter efficiencies .....	123

Figure 5.3. Components of a typical dry dust collection system for a surface drill .....	128
Figure 5.4. Airflow pattern within drill deck shroud leading to dust leakage and corner flaps added to rectangular deck shroud to reduce dust leakage.....	129
Figure 5.5. Air-blocking shelf installed on drill shroud and laboratory test configuration showing leakage through gaps in the drill shroud and blocking shelf .....	130
Figure 5.6. Dust released when material drops off of air-blocking shelf and modified design with short, overlapping sections supported by chains to maintain the 45-degree angle.....	131
Figure 5.7. Dust leakage through drill stem bushing on two different drills .....	131
Figure 5.8. Air ring seal designed to reduce leakage through drill stem bushing.....	132
Figure 5.9. Dust at collector dump before and after shroud installation.....	133
Figure 5.10. Impact on dust levels outside of the drill shroud when changing the collector-to-bailing airflow ratio and drill shroud gap height.....	134
Figure 5.11. Schematic showing internal components of water separator sub and water being discharged through weep holes .....	136
Figure 5.12. Examples of haul road dust generated by haul trucks .....	137
Figure 5.13. Graph showing dust levels measured at the roadside for a haul truck traveling at various speeds .....	139
Figure 5.14. Water trucks wetting haul roads with rear-mounted water sprays and a water distribution manifold.....	140
Figure 5.15. Various types of manufactured spray nozzles used to water roadways .....	140
Figure 5.16. Graph showing respirable dust concentrations measured along a haul road after water application occurred at 10:00.....	141
Figure 5.17. Staging curtains and local exhaust ventilation for controlling dust liberation at a primary dump .....	144
Figure 5.18. Illustration of a primary dump with full cone water sprays used for wetting while hollow cone sprays are used for airborne dust capture .....	145
Figure 6.1. Cross-section of a 1/100-inch-thick explosible float coal dust layer deposited on top of a 3/4-inch-thick layer of rock dust.....	152
Figure 6.2. Photo illustrating components of standard stainless steel IOM sampler. Illustration showing the nozzle adapter and isokinetic nozzle designed by NIOSH .....	154
Figure 6.3. External sampling housing with the TEOM unit inserted .....	155
Figure 6.4. Flooded bed scrubber unit and 12 water sprays used to wet filter panel.....	157
Figure 6.5. Return entry after a cut without and with flooded bed scrubber operating illustrating difference in float coal dust deposition.....	158
Figure 6.6. Impact of spray type, operating pressure, and orientation on reducing airborne float coal dust.....	159

Figure 6.7. Laboratory testing of a water curtain for reducing float dust on a longwall face.....160

Figure 6.8. Water sprays directed at top of coal stream being discharged from belt.....162

## LIST OF TABLES

Table I.1. Respirable dust concentrations by occupation in 1968 .....	1
Table I.2. Methodology for controlling respirable dust generation and worker exposure .....	4
Table 2.1. ACGIH/ISO size distribution definition of respirable dust .....	21
Table 5.1. Quartz samples collected between August 1, 2014, and December 31, 2019 by MSHA inspectors for bulldozer and highwall drill operators.....	119
Table 5.2. Comparison of enclosed cab performance measures.....	120
Table 5.3. Respirable dust sampling results for retrofitted filtration systems for enclosed cabs on mobile surface mining equipment.....	121
Table 5.4. Resulting protection factors for changes in enclosed cab model.....	124
Table 5.5. Summary of control efficiencies for haul road dust suppressants .....	143
Table 6.1. Summary of float and respirable dust levels for three different mining operations.....	156

## ACRONYMS AND ABBREVIATIONS USED IN THIS REPORT

AA	air atomizing
ACGIH	American Conference of Governmental Industrial Hygienists
ASABE	American Society of Agricultural and Biological Engineers
CDC	Centers for Disease Control and Prevention
CFR	Code of Federal Regulations
CM	continuous miner
CPDM	continuous personal dust monitor
CT	computed tomography
CWHSP	Coal Workers' Health Surveillance Program
CWP	coal workers' pneumoconiosis
DA	designated area
DO	designated occupation
DOL	Department of Labor
DWP	designated work position
DS	dry scrubber
EPA	Environmental Protection Agency
FAST	Field Analysis of Silica Tool
FC	full cone
FF	flat fan
FTIR	Fourier transform infrared
HA	hydraulic atomizing
HC	hollow cone
HDPE	high-density polyethylene
HEPA	high-efficiency particulate air
IARC	International Agency for Research on Cancer
ILO	International Labour Office
IOM	Institute of Occupational Medicine
ISO	International Organization for Standardization

LTA	low-temperature ashing
MMU	mechanized mining unit
MERV	minimum efficiency reporting value
MRE	Mining Research Establishment
MSHA	Mine Safety and Health Administration
NIOSH	National Institute for Occupational Safety and Health
ODO	other designated occupation
PCD	polycrystalline diamond
PDM	personal dust monitor
pDR	personal DataRAM
PEL	permissible exposure limit
PF	protection factor
PPE	personal protective equipment
PVC	polyvinyl chloride
PMF	progressive massive fibrosis
RB	roof bolter
SiO <sub>2</sub>	silicon dioxide
TEOM	tapered-element oscillating microbalance
USBM	U.S. Bureau of Mines
VFD	variable frequency drive



## UNIT OF MEASURE ABBREVIATIONS USED IN THIS REPORT

cfm	cubic feet per minute
cm	centimeter
dynes/cm	dynes per centimeter
fpm	feet per minute
gal/yd <sup>2</sup>	gallons per yard squared
gpm	gallons per minute
in. wc	inches of water column
lb <sub>f</sub> /in <sup>2</sup>	pound force per square inch
L/min	liters per minute
μg/m <sup>3</sup>	micrograms per cubic meter of air
μm	micrometers
mg/m <sup>3</sup>	milligrams per cubic meter of air
mph	miles per hour
mm	millimeters
psi	pounds per square inch

## **ACKNOWLEDGMENTS**

### **FIRST EDITION**

The following individuals are gratefully acknowledged by the lead author for their contributions to the first edition of this handbook, which was published by NIOSH in January 2010, under the same title. Some information provided by these authors was carried over to this second edition.

James P. Rider, Operations Research Analyst (retired), Pittsburgh Mining Research Division, National Institute for Occupational Safety and Health, Pittsburgh, PA.

Jeffrey M. Listak, Mining Engineer (retired), Pittsburgh Mining Research Division, National Institute for Occupational Safety and Health, Pittsburgh, PA.

John A. Organiscak, Mining Engineer (retired), Pittsburgh Mining Research Division, National Institute for Occupational Safety and Health, Pittsburgh, PA.

Anita L. Wolfe, Public Health Advisor (retired), Respiratory Health Division, National Institute for Occupational Safety and Health, Morgantown, WV.

### **SECOND EDITION**

The authors would like to thank the following from the Pittsburgh Mining Research Division of NIOSH, for reviewing sections of the handbook pertaining to their areas of expertise: Emanuele Cauda, General Engineer; Lauren Chubb, Physical Scientist; and Marcia Harris, General Engineer. The authors would also like to thank Janet Hale, Program Analyst, Respiratory Health Division of NIOSH for providing updated statistics on the prevalence of coal workers' pneumoconiosis and progressive massive fibrosis.

# Best Practices for Dust Control in Coal Mining

## Second Edition

Jay F. Colinet,<sup>1</sup> Cara N. Halldin,<sup>2</sup> Joseph Schall<sup>3</sup>

### INTRODUCTION

Respirable dust, defined as minus 10 micrometers ( $\mu\text{m}$ ) in size [ACGIH 2007], can be inhaled into the gas exchange region of the lungs and has long been known to be a serious health threat to workers in many industries. In coal mining, overexposure to respirable coal mine dust can lead to coal workers' pneumoconiosis (CWP), commonly known as black lung. CWP is a lung disease that can be disabling and fatal in its most severe form, progressive massive fibrosis (PMF). In addition, miners can be exposed to high levels of respirable silica dust, which can cause silicosis, another disabling and/or fatal lung disease. Once contracted, there is no cure for CWP or silicosis. The goal, therefore, is to limit worker exposure to respirable dust to prevent development of these lung diseases.

Prior to the passage of the Federal Coal Mine Health and Safety Act of 1969 (Public Law 91-173), no respirable dust exposure limits had been established in the U.S. coal mining industry. Also, no personal dust sampling was required to monitor the exposure of mine workers. However, in 1968, the U.S. Bureau of Mines (USBM) conducted personal dust sampling at a limited number of mines to assess worker exposures. The results from this sampling are summarized in Table I-1. These results show that mean respirable dust concentrations at these mines were substantially above contemporary dust standards, with maximum exposure levels approaching 40 milligrams per cubic meter of air ( $\text{mg}/\text{m}^3$ ) for two of the sampled occupations.

**Table I.1. Respirable dust concentrations by occupation in 1968 [USBM 1970]**

Occupation	No. of mines	No. of samples	Dust concentration range, $\text{mg}/\text{m}^3$	Mean, $\text{mg}/\text{m}^3$
Continuous miner operator	21	178	0.02–21.44	4.08
Continuous miner helper	19	131	0.44–18.90	3.47
Roof bolter operator	25	296	0.09–38.50	2.46
Cutting machine operator	15	98	0.71–15.42	3.69
Loading machine operator	18	97	0.25–39.56	3.75

---

<sup>1</sup> Principal Mining Engineer, Pittsburgh Mining Research Division, National Institute for Occupational Safety and Health, Pittsburgh, PA.

<sup>2</sup> Commander U.S. Public Health Service Commissioned Corps, Team Lead Coal Workers' Health Surveillance Program, Respiratory Health Division, National Institute for Occupational Safety and Health, Morgantown, WV.

<sup>3</sup> Health Communications Specialist, National Personal Protective Technology Laboratory, National Institute for Occupational Safety and Health, Pittsburgh, PA.

The passage of the Federal Coal Mine Health and Safety Act of 1969 was the initial regulatory step in controlling the respirable dust exposure of mine workers in the United States. This act established a respirable coal mine dust standard of 2 mg/m<sup>3</sup> (MRE equivalent concentration<sup>4</sup>), implemented a method designed to control silica exposure to a limit equivalent to 100 micrograms per cubic meter of air (µg/m<sup>3</sup>), defined dust sampling requirements for federal inspectors and mine operators, created a CWP surveillance program for underground coal miners, and established a CWP benefits program to provide compensation to affected miners and their surviving families.

After passage of the 1969 Act, the Coal Workers' Health Surveillance Program (CWHSP) was established by the National Institute for Occupational Safety and Health (NIOSH) [NIOSH 2019a]. Initial CWHSP data showed that approximately one in three examined miners with 25 or more years of experience was diagnosed with CWP [NIOSH 2019b]. A substantial drop in the prevalence of this lung disease was then observed in examined miners over the next 30 years. However, CWHSP data collected since 2000 has shown an upturn in the prevalence of CWP, particularly for the longest-tenured mine workers. Recent health surveillance data has also shown rapidly developing cases of CWP [Antao et al. 2005; Cohen et al. 2016] and a significant increase in miners diagnosed with PMF [Almberg et al. 2018].

Consequently, a new federal dust regulation was promulgated by the Mine Safety and Health Administration (MSHA) in 2014 [79 Fed. Reg.<sup>5</sup> 24814 (2014)] in an effort to further reduce the respirable dust exposure of coal mine workers. This new dust rule reduced the respirable coal mine dust standard to 1.5 mg/m<sup>3</sup> (MRE equivalent concentration), specified 100 µg/m<sup>3</sup> as a silica limit, required mine operators to use a new dust sampling instrument with real-time feedback to the miner, increased the number of compliance samples that need to be collected by mine operators, made surface coal mine workers eligible to participate in the CWHSP, added spirometry testing to the CWP surveillance program, and changed additional dust sampling requirements.

NIOSH supports the traditional hierarchy of controls approach to controlling occupational hazards, which is illustrated in Figure I-1. Generally, the controls are considered to be the most protective of workers as one proceeds from the top to the bottom of the inverted pyramid. Unfortunately, the nature of mining—where the extraction, processing, and transport of the desired product creates the respirable dust hazard—does not typically lend itself to using the elimination or substitution methods of controls. Administrative controls and personal protective equipment (PPE) are often used to supplement existing control technologies when hazards cannot otherwise be routinely controlled. However, these methods require a sustained effort by workers (e.g., diligently wearing a respirator) and management (e.g., respirator training or limiting time in an occupation) to avoid reducing the afforded protection. Therefore, the focus in mining is on developing and implementing engineering controls to protect workers.

---

<sup>4</sup> Mining Research Establishment (MRE) equivalent concentration defined in Chapter 2.

<sup>5</sup> Federal Register. See Fed. Reg. in references.

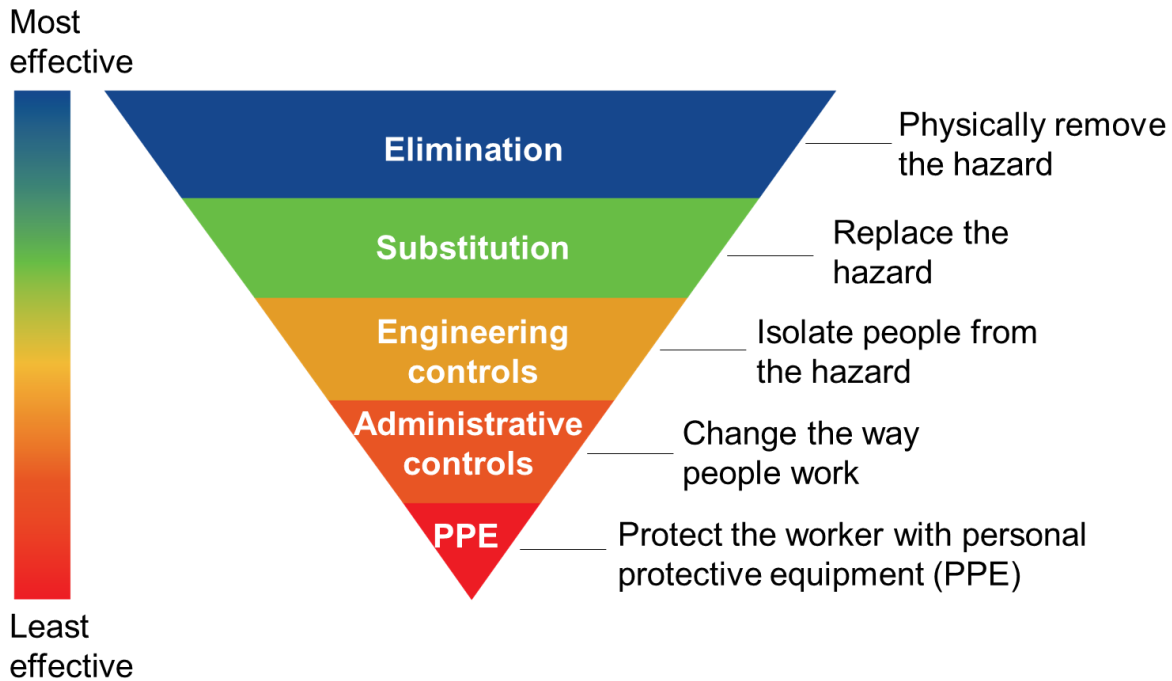

**Figure I.1. Hierarchy of controls approach for reducing workplace hazards [NIOSH 2015].**

Considering the ongoing increase and severity of lung disease in coal mining and changes in federal dust regulations, this handbook was updated to identify available engineering controls that can help the industry reduce worker exposure to respirable coal and silica dust. The controls discussed in this handbook range from long-utilized controls that have developed into industry standards to newer controls that are still being optimized and implemented. The intent is to identify the best practices that are available to control respirable dust levels in underground and surface coal mining operations.

A general methodology for controlling respirable dust generation and worker exposures is provided in Table I.2. As shown, the initial step should be to minimize the quantity of respirable dust that is generated through efficient cutting. If the dust is not created, it does not have to be controlled through other means. The next step would be to prevent the respirable dust that is generated from becoming airborne so that it cannot harm workers. For the dust that does get entrained into the ventilating air, the next step would be to remove it with dust collectors and dilute it with ventilation. Another step would be to prevent any remaining airborne respirable dust from reaching the breathing zones of workers. If the dust is not inhaled by workers, it cannot contribute to the development of lung disease. The last step in the process is to maintain the controls that have been implemented to retain their effectiveness.

In addition to the health hazards associated with respirable dust generated during coal mining, float coal dust generation creates a potential safety hazard. Float coal dust is defined as minus 75  $\mu\text{m}$  in size and settles out of the ventilating air onto the floor, roof, and ribs of mine entries [Harris et al. 2009]. This dust has contributed to numerous mine disasters by being lifted back into the air, typically by a methane gas explosion, and propagating a more violent coal dust explosion throughout the mine. MSHA regulations require that rock dust be applied in sufficient

quantities to inert deposited coal dust. In recent years, NIOSH has initiated research into developing engineering controls that reduce the quantity of float coal dust deposition in mine entries, which will provide mine operators additional tools for controlling this safety hazard.

**Table I.2. Methodology for controlling respirable dust generation and worker exposure [Colinet 2020]**

<b>Step</b>	<b>Goal—approach (examples)</b>
<b>1</b>	<b>Minimize the quantity of respirable dust generated</b> —employ efficient cutting (drum and bit design, cutting method)
<b>2</b>	<b>Prevent respirable dust from getting into the ventilating air</b> —wet dust at generation point (water sprays) —enclose the dust source (stageloader, belt transfers)
<b>3</b>	<b>Remove respirable dust from the ventilating air</b> —dust collectors (flooded bed scrubbers, vacuum collectors) —water sprays (nozzle type, operating parameters)
<b>4</b>	<b>Dilute remaining airborne dust</b> —ventilation quantity (maximize) —increase distance from dust source (shield advance, continuous miner cuts)
<b>5</b>	<b>Prevent respirable dust from reaching workers’ breathing zones</b> —ventilation velocity (quickly move dust) —move air with water sprays (directional sprays, blocking sprays) —physical barriers (belting, enclosed cabs)
<b>6</b>	<b>Regular maintenance of controls to retain effectiveness</b>

It cannot be stressed enough that after appropriate control technologies are implemented, the ultimate success of ongoing protection for workers depends on the proper use and continued maintenance of these controls. At some mining operations, NIOSH researchers have observed appropriate controls installed, but the effectiveness of these controls was diminished because of the lack of proper maintenance. For example, worn cutting bits [Pollock et al. 2010] and reduced flooded-bed scrubber airflow [NIOSH 2011; NIOSH 2013] can result if controls are not being maintained at necessary intervals, particularly when cutting rock. At these operations, mine operators must make the maintenance of these dust control technologies a higher priority and provide mine workers the training, resources, and time needed to complete this maintenance.

This handbook provides general information on engineering control technologies along with extensive references. In some cases, the full reference or references will need to be consulted to gain in-depth information on the testing or implementation of the control of interest. The handbook is divided into six chapters. Chapter 1 discusses the health effects of exposure to respirable coal and silica dust. Chapter 2 discusses dust sampling instruments and sampling methods. Chapters 3, 4, and 5 focus on respirable dust control technologies for longwall mining, continuous mining, and surface mining, respectively. Chapter 6 discusses float coal dust sampling and control technologies.

## References for Introduction

79 Fed. Reg. 24814 [2014]. Mine Safety and Health Administration: Lowering miners' exposure to respirable coal mine dust, including continuous personal dust monitors; final rule. To be codified at 30 CFR Parts 70, 71, 72, 75, and 90.

ACGIH [2007]. Appendix C: Particle size-selective sampling criteria for airborne particulate matter. In: 2007 TLVs and BEIs. Cincinnati, OH: American Conference of Governmental Industrial Hygienists.

Almberg KS, Halldin CN, Blackley DJ, Laney AS, Storey E, Rose CS, Go LHT, Cohen RA [2018]. Progressive massive fibrosis resurgence identified in U.S. coal miners filing for black lung benefits, 1970–2016. *Ann Am Thorac Soc* 15(12):1420–1426.

Antao VC, Petsonk EL, Sokolow LZ, Wolfe AL, Pinheiro GA, Hale JM, Attfield MD [2005]. Rapidly progressive coal workers' pneumoconiosis in the United States: geographic clustering and other factors. *Occup Environ Med* 62(10):670–674.

Cohen RA, Petsonk EL, Rose C, Young B, Regier M, Najmuddin A, Abraham JL, Churg A, Green FHY [2016]. Lung pathology in U.S. coal workers with rapidly progressive pneumoconiosis implicates silica and silicates. *Am J Respir Crit Care Med* 193(6):673–680.

Colinet JF [2020]. The impact of black lung and a methodology for controlling respirable dust. *Min Metal Expl* 37(6):1847–1856.

Harris ML, Cashdollar KL, Man CK, Thimons ED [2009]. Mitigating coal dust explosions in modern underground coal mines. In: Panigrahi DC, ed. *Proceedings of the Ninth International Mine Ventilation Congress*, New Delhi, India, pp. 143–149.

NIOSH [2011]. Evaluation of face dust levels at mines using deep-cutting practices. By Potts JD, Reed WR, Colinet JF. U.S. Department of Health and Human Services, Centers for Disease Control and Prevention, National Institute for Occupational Safety and Health, Report of Investigations 9680.

NIOSH [2013]. Impact on respirable dust levels when operating a flooded-bed scrubber in 20-foot cuts. By Colinet JF, Reed WR, Potts JD, U.S. Department of Health and Human Services, Centers for Disease Control and Prevention, National Institute for Occupational Safety and Health, Report of Investigations 9693.

NIOSH [2015]. Hierarchy of controls. Centers for Disease Control and Prevention, National Institute for Occupational Safety and Health.

<https://www.cdc.gov/niosh/topics/hierarchy/default.html>

NIOSH [2019a]. Coal Workers' Health Surveillance Program. U.S. Department of Health and Human Services, Centers for Disease Control and Prevention, National Institute for Occupational Safety and Health, <https://www.cdc.gov/niosh/topics/cwhsp/default.html>

NIOSH [2019b]. Coal Workers' Health Surveillance Program (CWHSP) Data Query System. Centers for Disease Control and Prevention, National Institute for Occupational Safety and Health, Respiratory Health Division, Surveillance Branch, <https://webappa.cdc.gov/ords/cwhsp-database.html>

Pollock DE, Potts JD, Joy GJ [2010]. Investigation into dust exposures and mining practices in mines in the southern Appalachian region. *Min Eng* 62(2):44–49.

USBM [1970]. Dust concentration in mines. By Doyle HN. In: Proceedings of the symposium on respirable coal mine dust, Washington, D.C., November 3–4, 1969. Washington, D.C., U.S. Department of the Interior, Bureau of Mines, Information Circular 8458, pp. 27–32.



# CHAPTER 1: HEALTH EFFECTS OF OVEREXPOSURE TO RESPIRABLE COAL AND SILICA DUST

Pneumoconioses are lung diseases caused by the inhalation and deposition of respirable mineral dusts in the lungs. Pneumoconioses associated with working in an industry such as mining are coal workers' pneumoconiosis (CWP), mixed dust pneumoconiosis, and silicosis. Once these diseases manifest, they cannot be cured and can continue to progress in severity. Therefore, it is critical to limit worker exposure to airborne respirable dust to prevent the development of these diseases.

## Coal Workers' Pneumoconiosis

CWP, commonly called black lung disease, is a chronic lung disease that results from the inhalation and deposition of coal mine dust in the lung and the lung tissue's reaction to its presence. It is associated with workers who mine, process, or ship coal. In addition to CWP, coal mine dust exposure increases a miner's risk of developing chronic bronchitis, chronic obstructive pulmonary disease, and pathologic emphysema [NIOSH 1995].

With continued exposure to coal mine dust, the lungs undergo structural changes that are eventually seen on a chest x-ray. In the early stage of disease (simple CWP), there may be no symptoms. However, when symptoms do develop, they include cough (with or without mucus), wheezing, and shortness of breath (especially during exercise). If a person has inhaled too much coal mine dust, simple CWP can progress to progressive massive fibrosis (PMF) where the structural changes in the lung are called fibrosis. PMF is the formation of large tough, fibrous scar tissue deposits in the areas of the lung that have become irritated and inflamed, thus replacing the regions of the lung where oxygen/carbon dioxide exchange normally occurs. The development of PMF causes the lungs to become stiff and their ability to expand fully is reduced. This ultimately interferes with the lung's normal exchange of oxygen and carbon dioxide and breathing becomes very difficult. The patient's lips and fingernails may have a bluish tinge, and there may be fluid retention and signs of heart failure. Figure 1.1 shows whole lung sections of a normal lung (left), simple CWP (center), and PMF (right).

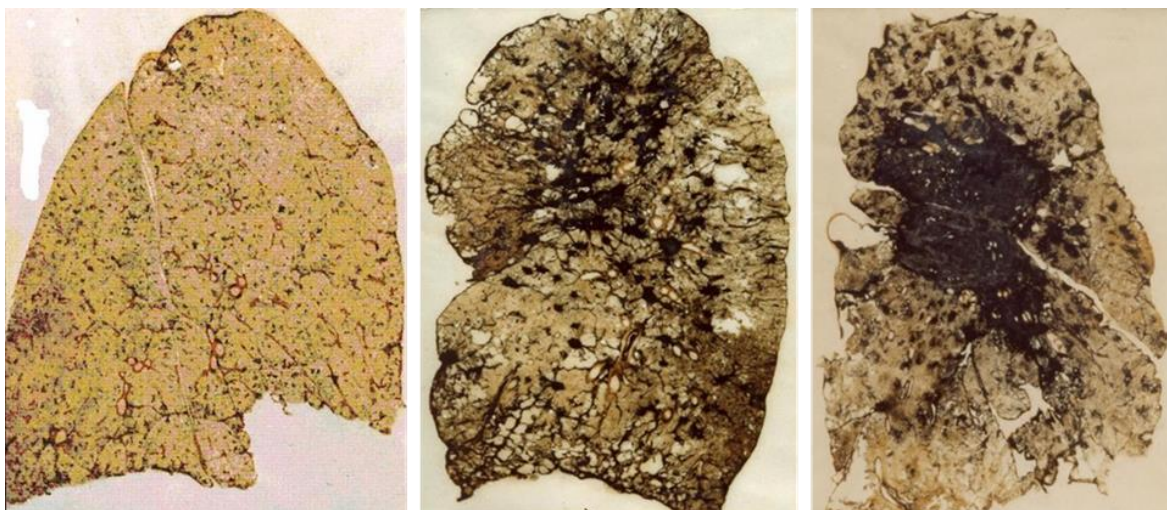

Photos by NIOSH

**Figure 1.1. Whole lung sections of normal lung (left), simple CWP (center), and PMF (right).**

Simple CWP is characterized by the presence of small opacities (opaque spots) on the chest x-ray that are less than 10 millimeters (mm) in diameter. The profusion (density) of small opacities is classified as major category 1, 2, or 3 as defined by the International Labour Office (ILO) guidelines [ILO 2011]. Category 0 is defined as the absence of small opacities or opacities that are less profuse than the lower limit of category 1. Within the ILO profusion scale, each major category may be followed by a subcategory if an adjacent main category was considered during classification (e.g., classification 1/2 was judged as category 1, but category 2 was seriously considered) [NIOSH 1995].

PMF is classified as category A, B, or C when large opacities with a combined area of 1 centimeter (cm) or larger are found on the chest radiograph. PMF usually develops in miners already affected by simple CWP but can develop in miners with no previous radiographic evidence of simple CWP [NIOSH 1995]. Figure 1.2 provides radiographic examples of healthy and diseased lungs based upon the ILO severity classification system. In radiographs, unobstructed lungs appear black, while the bones, heart, diaphragm, and dust-impacted areas of the lungs appear white.



Photos by NIOSH

**Figure 1.2. ILO Standard Radiographs demonstrating no pneumoconiosis (left), simple CWP category 2/2 (center), and PMF category C (right).**

There is no specific therapy for these diseases. Primary prevention of lung disease in miners must include continued efforts to reduce coal mine dust exposure. Medical management is best directed at prevention, early recognition, and treatment of complications. The major clinical challenges are the recognition and management of airflow obstruction, respiratory infection, hypoxemia (an abnormally low amount of oxygen in the blood), respiratory failure, cor pulmonale (enlargement of the right side of the heart), arrhythmias (abnormal heart rhythm), and pneumothorax (collapsed lung).

With the passage of the Federal Coal Mine Health and Safety Act of 1969 (Public Law 91-173), the Mine Safety and Health Administration (MSHA) enforced regulations designed to limit mine workers' exposure to respirable coal mine dust to a maximum of 2 milligrams per cubic meter of air ( $\text{mg}/\text{m}^3$ ) if the silica content in the sample is less than 5%. MSHA inspectors and mine operators conducted periodic sampling to demonstrate compliance with this dust limit. In underground coal mines, airborne dust concentrations are typically the highest for workers involved in production activities at the mining face. Longwall shearer operators, jacksetters, continuous miner operators, and roof bolter operators are occupations with greater potential for exposure to excessive levels of respirable coal mine dust. Workers in some aboveground coal

mining support operations also have increased exposure to coal mine dust. These include workers at preparation plants where crushing, sizing, washing, and blending of coal are performed and at tipplers where coal is loaded into trucks, railroad cars, river barges, or ships.

Also included in the 1969 Act was the establishment of the NIOSH Coal Workers' Health Surveillance Program (CWHSP) [NIOSH 2019a]. As part of this program, underground coal miners are required to have an initial chest x-ray when they begin employment. Underground coal miners also have the opportunity to voluntarily receive periodic chest x-rays (free of charge to the miner) in an effort to detect the presence of CWP at its earliest stage of development. An individual miner is eligible to receive an x-ray approximately every five years.

Because underground coal miners are eligible to participate in the CWHSP about every five years, surveillance data has been summarized over five-year periods to provide an industry-wide assessment of CWP over time as shown in Figure 1.3. The rates of black lung observed in examined miners steadily declined from 1970 through 1999 [NIOSH 2019b]. However, more recent data shows that the declines have stopped and rates are rising. For miners with 25 or more years of experience who were examined in the CWHSP after the year 2000, the rate of black lung being found across the industry has more than tripled to over 14% [Hale 2021]. However, this increase has not been seen uniformly across the U.S. mining industry. In the central Appalachian region that includes eastern Kentucky, southern West Virginia, and southwestern Virginia, approximately 20% of examined miners were found to have CWP [Blackley et al. 2018a]. In addition, CWP is being found in younger miners and is advancing to more severe stages more rapidly than seen before, particularly in the central Appalachian mining region [Antao et al. 2005].

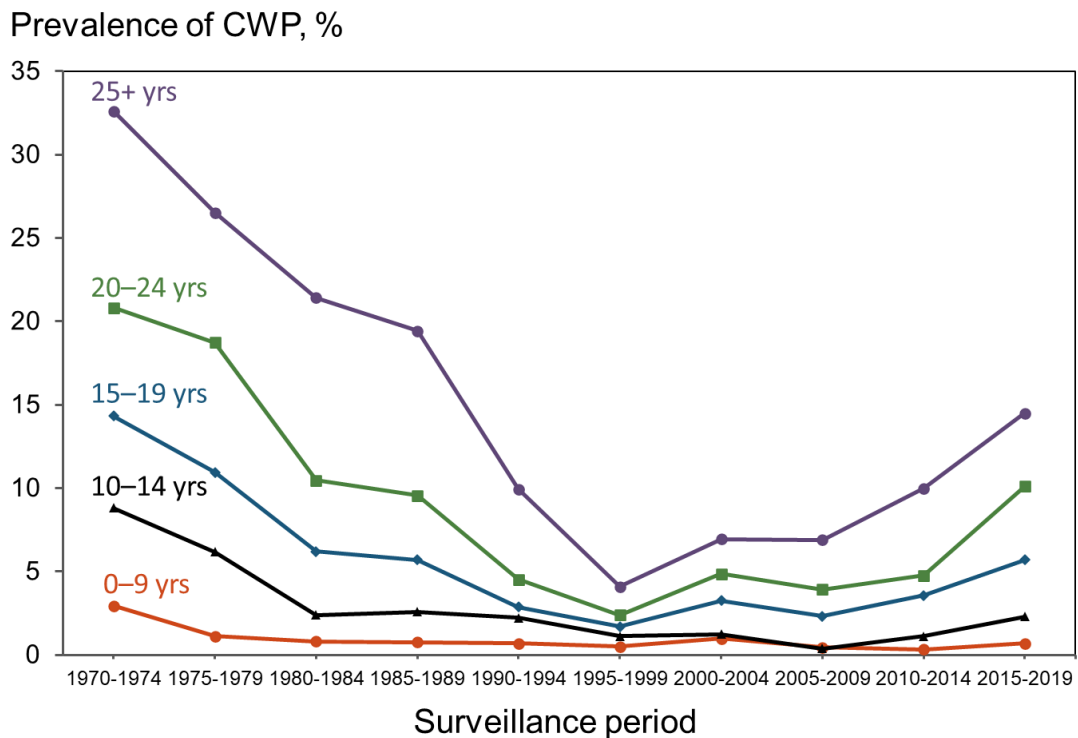

**Figure 1.3. Percentage of examined underground coal miners with CWP Category 1 or greater by tenure in mining.**

Data is also available that quantifies coal miners' deaths where CWP was recorded as the underlying or contributing cause. From 1970 through 2016, CWP was identified in the deaths of 75,178 miners [CDC 2019].

The occurrence of PMF has also seen an unexpected increase in prevalence over the last 20 years. In the CWHSP database [NIOSH 2019b], the prevalence of PMF for active underground miners with 10 or more years of experience had dropped to a program low of 0.1% in the 1990 to 1994 surveillance period as shown in Figure 1.4. However, from 2010 to 2019, the prevalence of PMF increased over 10-fold to over 1% [Hale 2021]. Recent research with former coal miners found that CWP can develop and/or progress to PMF absent further coal mine dust exposure, even among miners with no radiographic evidence of CWP when leaving the industry [Almberg et al. 2020]. For nearly half of these miners, the disease progression occurred in five years or less, illustrating the importance of regular medical surveillance even after employment ceases.

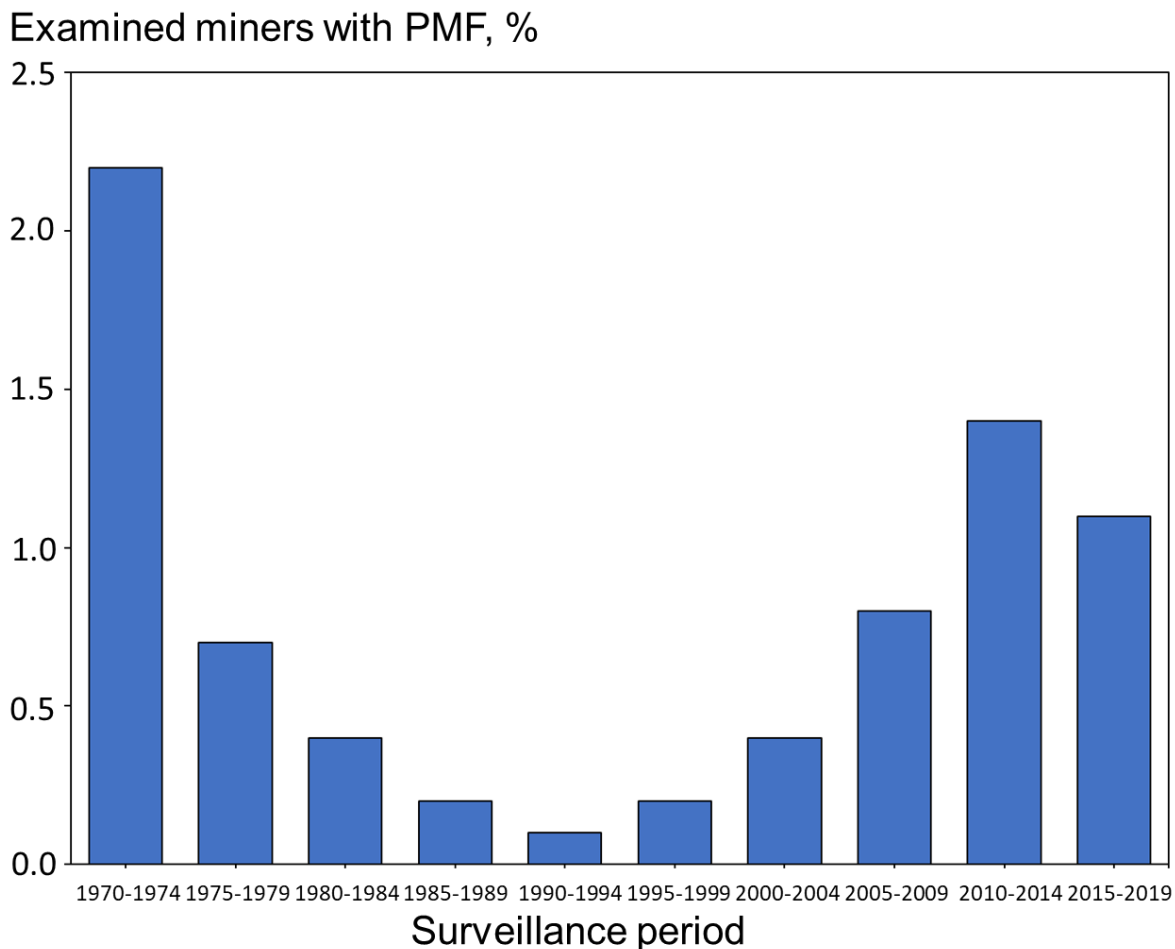

**Figure 1.4. Percentage of underground miners examined in the CWHSP that were found to have PMF.**

Additional evidence of increases in cases of PMF is found when examining data from miners filing for benefits under the Federal Black Lung Benefits program. Since its inception, the percentage of these miners that were found to have PMF in each decade has increased over five-fold [Almberg et al. 2018], as shown in Figure 1.5.

### Claimants with PMF determination, %

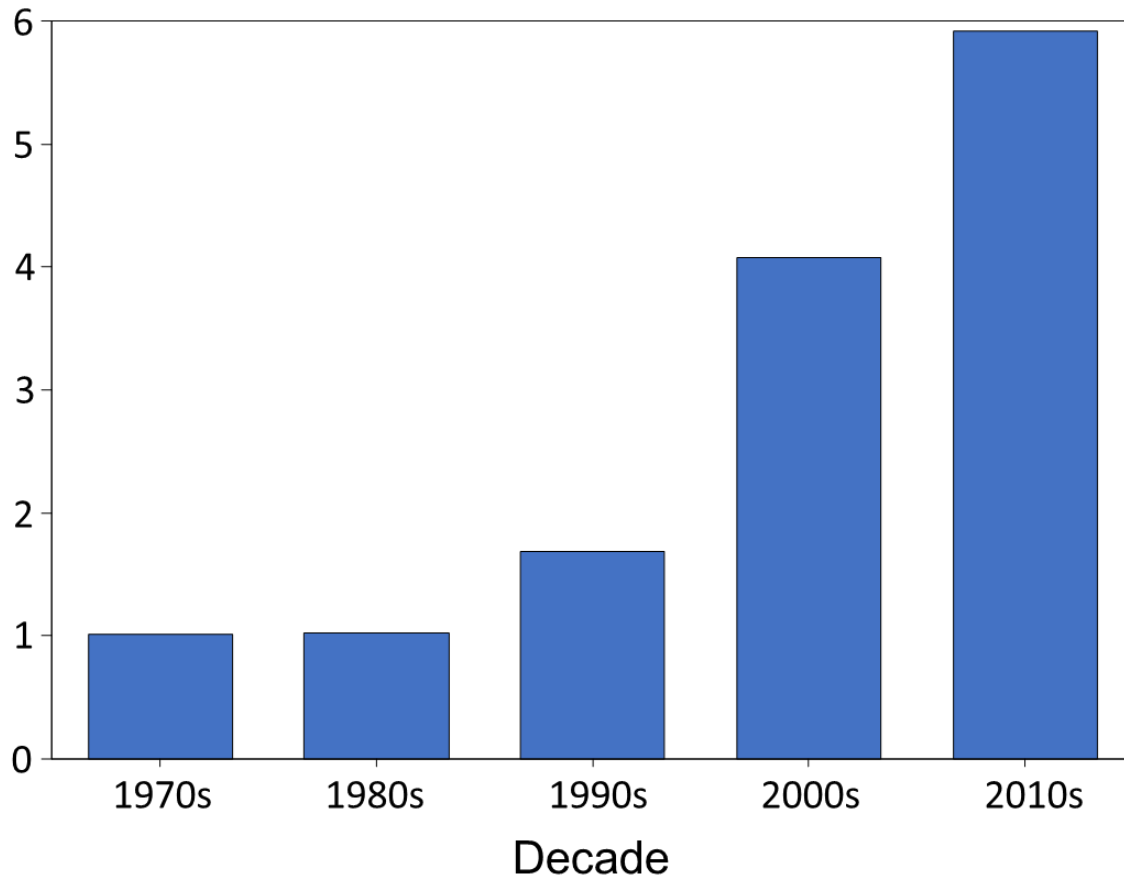

**Figure 1.5. Percentage of miners filing for federal black lung benefits between 1970 and 2016 that were found to have PMF.**

At a radiology practice in eastern Kentucky, 60 cases of PMF were identified in former miners examined between January 2015 and August 2016 [CDC 2016]. Between 2013 and 2017, 416 cases of PMF were identified among current and former coal miners at a small network of black lung clinics in southwestern Virginia [Blackley et al. 2018b].

The 1969 Act created a federal Black Lung Benefits Program. In this program, underground coal miners that have become disabled could apply for benefits, which include monthly compensation and medical expense payments. The Office of Workers Compensation within the Department of Labor (DOL) now administers this program and documents yearly costs [DOL 2021]. In 2020, over \$220 million in benefits were paid. From 1971 through 2020, over \$47.3 billion in payouts were made.

The 1969 Act also established procedures (30 CFR<sup>6</sup> Part 90) for miners with evidence of pneumoconiosis the right to work in an area of a mine where the average concentration of respirable dust in the mine atmosphere during each shift is continuously maintained at or below 1.0 mg/m<sup>3</sup>. The rule set forth procedures for miners to exercise this option and established the right of miners to retain their regular rate of pay and receive wage increases. The rule also set forth the mine operator's obligations, including respirable dust sampling requirements for these Part 90 miners. The goal is to prevent further development of pneumoconiosis in the affected miner. However, between 1986 and 2016, only 14.4% of the miners eligible for Part 90 rights exercised this option [Reynolds et al. 2018a]. Of the miners who exercised their Part 90 transfer option and afterwards also participated in the CWHSP at least once, 32% showed further progression after exercising the Part 90 option. These miners had more severe disease prior to exercising, compared to miners that did not show progression, suggesting the importance of early detection of pneumoconiosis and prompt reduction in respirable dust exposure to prevent progression to severe disease [Hall et al. 2020].

The unexpected increases in CWP and PMF contributed to MSHA promulgating a new dust rule in 2014 [79 Fed. Reg.<sup>7</sup> 24814 (2014)]. Among the many changes contained in this rule, the respirable dust standard was lowered to 1.5 mg/m<sup>3</sup>, while the standard for Part 90 miners was lowered to 0.5 mg/m<sup>3</sup>. Implementation of these new dust standards began on August 1, 2016. This rule also requires occupational compliance sampling to be conducted with a continuous personal dust monitor (discussed in Chapter 2) and to encompass the entire work shift regardless of length. In the 1969 Act, compliance sampling was only conducted for eight hours even if the scheduled work shift was 10 or 12 hours long. Also, production must be at least 80% of the average tonnage over the last 30 shifts compared to 50% of the average tonnage from the last sampling period in the 1969 Act. Consequently, the new rule provides an opportunity to gain a more realistic measure of the full-shift dust exposure of coal mine workers. Also, as recommended by NIOSH [1995], the rule added lung function testing (spirometry) and a respiratory assessment questionnaire to the medical screening program and extended screening to surface coal miners.

## Silicosis

Occupational exposures to respirable crystalline silica occur in a variety of industries and occupations because of its extremely common natural occurrence. Workers with high exposure to crystalline silica include miners, sandblasters, tunnel builders, silica millers, quarry workers, foundry workers, and ceramics and glass workers. As taken from the NIOSH Hazard Review publication [NIOSH 2002], silica refers to the chemical compound silicon dioxide (SiO<sub>2</sub>), which occurs in a crystalline or noncrystalline (amorphous) form. Crystalline silica may be found in more than one form: alpha quartz, beta quartz, tridymite, and cristobalite [USBM 1992a; Heaney 1994]. In nature, the alpha form of quartz is the most common [Virta 1993]. This form is so abundant that the term quartz is often used instead of the general term crystalline silica [USBM 1992b; Virta 1993].

---

<sup>6</sup> Code of Federal Regulations. See CFR in references.

<sup>7</sup> Federal Register. See Fed. Reg. in references.

Quartz is a common component of rocks. Underground mine workers are potentially exposed to quartz dust when rock within or adjacent to the coal seams is cut, crushed, and transported. In surface coal mining, rock strata above the coal seam is typically drilled, blasted, and removed, resulting in occupations such as drillers and bulldozer operators being exposed to quartz dust. Occupational exposures to respirable crystalline silica are associated with the development of silicosis, lung cancer, pulmonary tuberculosis, and airways diseases. These exposures may also be related to the development of autoimmune disorders, chronic renal disease, and other adverse health effects [NIOSH 2002]. In 1996, the International Agency for Research on Cancer (IARC) reviewed the published experimental and epidemiologic studies of cancer in animals and workers exposed to respirable crystalline silica. The IARC concluded that there was sufficient evidence to classify silica as a human carcinogen [IARC 1997]. In a subsequent update, the IARC cited additional research and reaffirmed silica as a human carcinogen [IARC 2009].

Silicosis is also a fibrosing disease of the lungs caused by the inhalation, retention, and pulmonary reaction to the crystalline silica. The main symptom of silicosis is usually dyspnea (difficult or labored breathing and/or shortness of breath). This is first noted with activity or exercise and later at rest as the functional reserve of the lung is also lost. However, in the absence of other respiratory disease, there may be no shortness of breath and the disease may first be detected through an abnormal chest x-ray. The x-ray may at times show quite advanced disease with only minimal symptoms. The appearance or progression of dyspnea may indicate other complications, including tuberculosis, airways obstruction, PMF, or cor pulmonale. A productive cough is often present.

A worker may develop one of three types of silicosis, depending on the airborne concentrations of respirable crystalline silica that were inhaled:

- (1) *Chronic Silicosis*: Usually occurs after 10 or more years of exposure at relatively low concentrations. Swellings caused by the silica dust form in the lungs and chest lymph nodes. This disease may cause people to have trouble breathing and may be similar to chronic obstructive pulmonary disease.
- (2) *Accelerated Silicosis*: Develops 5–10 years after the first exposure. Swelling in the lungs and symptoms occur faster than in chronic silicosis.
- (3) *Acute Silicosis*: Develops after exposure to high concentrations of respirable crystalline silica and results in symptoms within a period of a few weeks to five years after initial exposure [Parker and Wagner 1998; Peters 1986]. The lungs become very inflamed and can fill with fluid, causing severe shortness of breath and low blood oxygen levels.

PMF can occur in either chronic or accelerated silicosis but is more common in the latter. Figure 1.6 shows sections of lungs that have been damaged by silicosis.

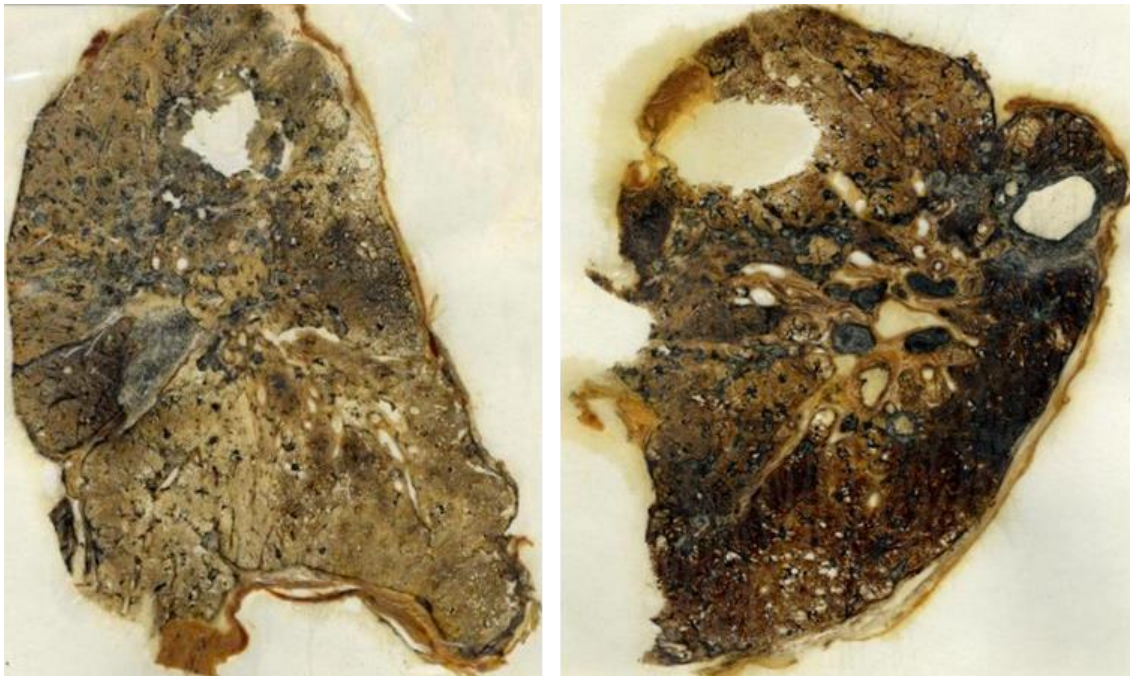

Photos by NIOSH

**Figure 1.6. Sections of freeze-dried human lungs with silicosis (left) and PMF (right).**

To prevent the development of silicosis, MSHA began regulating the exposure of mine workers to silica in the 1969 Act. For coal mining operations, gravimetric samples collected to monitor compliance with the  $2 \text{ mg/m}^3$  dust standard could be analyzed for quartz content. For quartz levels up to 5% in these compliance dust samples, no additional action was taken. However, if the percent quartz in the sample exceeded 5%, a reduced dust standard in  $\text{mg/m}^3$  was calculated by dividing 10 by the percent quartz. For example, if a sample contained 10% quartz, the reduced standard would be equal to  $1 \text{ mg/m}^3$  ( $10 \div 10\%$  quartz). These regulations were designed to limit the exposure to respirable quartz to 100 micrograms per cubic meter of air ( $\mu\text{g/m}^3$ ), although this limit was not specifically quantified in the regulation.

An analysis of MSHA compliance sampling data indicated that this indirect method of controlling silica exposure did not always achieve the desired results. This analysis showed that 11.7% of samples that were below the applicable respirable dust standard had silica levels that exceeded  $100 \mu\text{g/m}^3$  [Joy 2012]. Additionally, 4.4% of samples containing less than 5% quartz had quartz content exceeding  $100 \mu\text{g/m}^3$ . Subsequently, in the 2014 MSHA dust rule, a limit of  $100 \mu\text{g/m}^3$  is specifically identified and silica levels in compliance samples are compared to this limit directly to determine compliance. If elevated silica levels are present, a reduced dust standard is calculated in the same manner as described in the previous paragraph, but the reduced standard cannot exceed the general  $1.5 \text{ mg/m}^3$  dust standard.

As noted in the previous section, the prevalences of CWP and PMF have shown unexpected and dramatic increases since 2000. One factor that has been mentioned as a possible contributor to these trends is increased exposure to silica dust. Miners from central Appalachia diagnosed with PMF have indicated that substantial amounts of rock were extracted with the coal during routine mining at the face [Reynolds et al. 2018b; CDC 2016]. In addition, some of these miners reported cutting through sandstone rolls or driving slopes through rock for extended periods.



Compliance sampling would not likely capture exposures during these nonroutine but high-dust-producing mining events.

When examining chest radiographs, the presence of r-type opacities has been associated with silica exposure and silicosis pathology [Ruckley et. al. 1984; Soutar and Collins 1984]. NIOSH conducted a retrospective analysis of chest radiographs from underground coal miners examined in the decades of the 1980s through the 2010s. The presence of r-type opacities was quantified as shown in Figure 1.7 [Hall et al. 2019]. This data indicates that greater exposure to silica dust has been occurring in the central Appalachian region and likely contributes to the observed increase in CWP and PMF in these mines.

### Percentage of r-type opacity

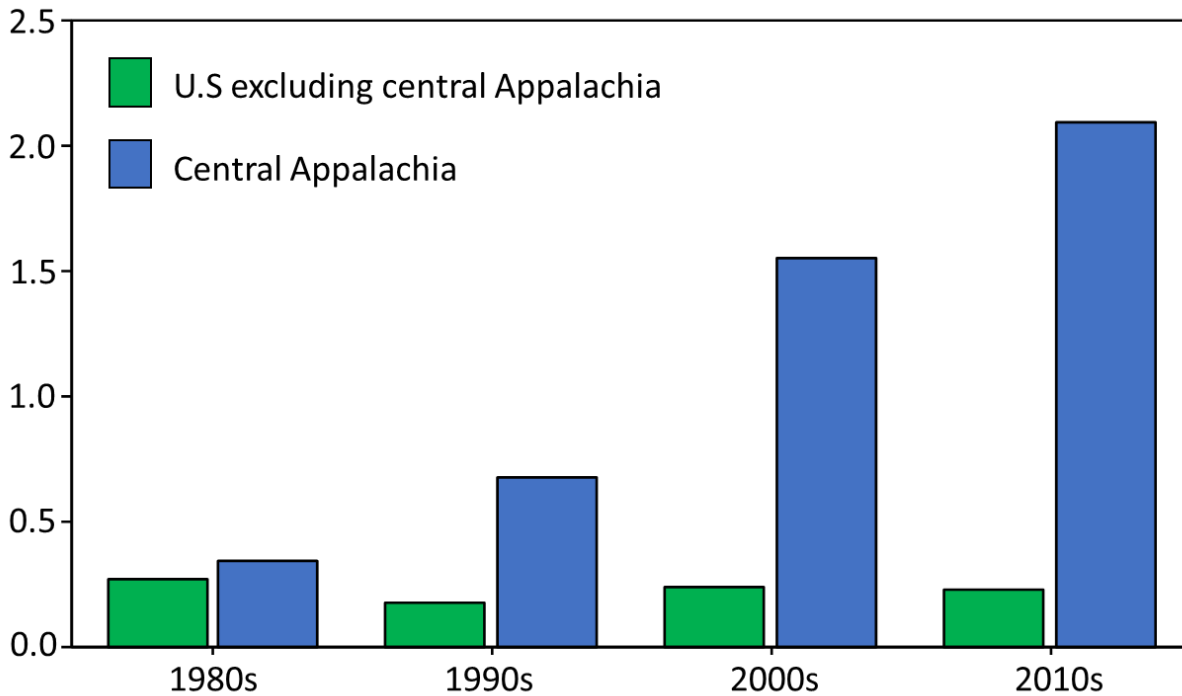

**Figure 1.7. Percentage of r-type opacities by region and decade from 1980 through 2018.**

In 2010 and 2011, NIOSH obtained chest radiographs from 2,257 surface coal miners through the CWHSP’s mobile outreach program and found CWP in 46 miners (2%), with 12 of these miners having PMF [CDC 2012]. Thirty-seven of the miners with CWP and nine with PMF had never worked underground, indicating that their occupational dust exposure came from surface coal mining work. A case-series follow-up of the nine surface miners with PMF revealed that all had worked as a drill operator and/or blaster for a majority of their careers [Halldin et al. 2015].

A high proportion of these radiographs contained r-type opacities, suggesting exposure to respirable crystalline silica. For the miners diagnosed with CWP and PMF, 31 (67%) and 10 (83%) of these miners, respectively, were from the central Appalachian region, while central Appalachian miners only accounted for 37% of the miners examined.

## Diagnosis and Treatment of Pneumoconioses

CWP or silicosis may be diagnosed based on the combination of an appropriate history of exposure to coal mine dust or silica, compatible changes in chest imaging or lung pathology, and absence of plausible alternative diagnoses. A chest radiograph is often sufficient for diagnosis, but in some cases a computed tomography (CT) scan of the chest can be helpful. Lung biopsy, a procedure where a sample of lung tissue is taken for lab examination, is not usually required if a compatible exposure history and findings on chest imaging are present. Pulmonary function tests and blood tests to measure the amounts of oxygen and carbon dioxide in the blood (arterial blood gases) can help in objectively assessing the level of impairment caused by CWP or silicosis.

As provided in the NIOSH Hazard Review [NIOSH 2002], epidemiologic studies of gold miners in South Africa, granite quarry workers in Hong Kong, metal miners in Colorado, and coal miners in Scotland have shown that chronic silicosis may develop or progress even after occupational exposure to silica has been discontinued [Hessel et al. 1988; Hnizdo and Sluis-Cremer 1993; Ng et al. 1987; Kreiss and Zhen 1996; Miller et al. 1998]. Therefore, removing a worker from exposure after diagnosis does not guarantee that silicosis or silica-related disease will stop progressing or that an impaired worker's condition will stabilize [Parker and Wagner 1998; Weber and Banks 1994; Wagner 1994].

Treatment of CWP or silicosis may include use of bronchodilators (medications to open the airways) or supplemental oxygen use. Once disease is detected, it is important to protect the lungs against respiratory infections. Thus, a doctor may recommend vaccinations to prevent influenza and pneumonia. In some cases of severe disease, a lung transplant may be recommended, with transplants resulting from CWP increasing in recent years [Blackley et al. 2016]. Prognosis depends on the specific type of pneumoconiosis and the duration and level of dust exposure. Among those with CWP receiving a lung transplant, the median post-transplant survival time was 3.7 years.

There is no cure for these lung diseases, and they can be deadly. Effective control technologies must be implemented and continually maintained to prevent initial development of the disease. If either CWP or silicosis does develop, early detection is advantageous for the long-term health and care of the worker. Consequently, participation in the CWHSP at recommended intervals throughout a miner's career is a valuable asset available to U.S. coal miners and is encouraged by NIOSH. Participation in the Part 90 program is another valuable asset that can help reduce subsequent dust exposure for miners continuing to work after being diagnosed with CWP.

## Faces of Black Lung Videos and Information Booklet

To illustrate the severe impact that CWP, especially PMF, can have on someone's life, NIOSH has produced two videos in which miners suffering from PMF were interviewed.<sup>8</sup> In the 2008 video (Faces of Black Lung, Figure 1.8, left), a 55-year-old and a 58-year-old miner at the time of being interviewed discussed how their disease limited their normal abilities and impacted their family life. The 58-year-old miner died seven months after being interviewed. The 55-year-old miner eventually had a double-lung transplant but then died four months afterward at the age of 60.

In the 2020 video (Faces of Black Lung II, Figure 1.8, right), three younger miners suffering from PMF were interviewed. These miners were only 39, 42, and 47 years old at the time of the interviews. These miners also discuss the impact the disease has had on their lives and their families. The 42-year-old miner died between the time of his interview and the video being released.

An information booklet to accompany the Faces of Black Lung II video is also available on the NIOSH website.<sup>9</sup>



Figure 1.8. Covers of original Faces of Black Lung videos produced by NIOSH.

<sup>8</sup> Faces of Black Lung video on the NIOSH YouTube channel: <https://www.youtube.com/watch?v=H2U9Onrxepg>  
Faces of Black Lung II video on the CDC YouTube channel: <https://www.youtube.com/watch?v=X-agtyN4py4>

<sup>9</sup> Faces of Black Lung II informational booklet: <https://www.cdc.gov/niosh/docs/2020-109/pdfs/2020-109.pdf?id=10.26616/NIOSH PUB2020109>

## References for Chapter 1

- Almberg KS, Halldin CN, Blackley DJ, Laney AS, Storey E, Rose CS, Go LHT, Cohen RA [2018]. Progressive massive fibrosis resurgence identified in U.S. coal miners filing for black lung benefits, 1970-2016. *Annals American Thoracic Society* 15(12):1420–1426. Data accessed from online supplement:  
<https://www.atsjournals.org/doi/suppl/10.1513/AnnalsATS.201804-261OC>
- Almberg KS, Friedman LS, Rose CS, Go LHT, Cohen RA [2020]. Progression of coal workers' pneumoconiosis absent further exposure. *Occup Env Med* 77(11):748–751.
- Antao VC, Petsonk EL, Sokolow LZ, Wolfe AI, Pinheiro GA, Hale JM, Attfield MD [2005]. Rapidly progressive coal workers' pneumoconiosis in the United States: geographic clustering and other factors. *Occup Env Med* 62(10):670–674.
- Blackley DJ, Halldin CN, Cummings KJ, Laney AS [2016]. Lung transplantation is increasingly common among patients with coal workers' pneumoconiosis. *Am J Ind Med* 59(3):175–177.
- Blackley DJ, Halldin CN, Laney AS [2018a]. Continued increase in prevalence of coal workers' pneumoconiosis in the United States, 1970–2017. *Am J Pub Health* 108(9):1220–1222.
- Blackley DJ, Reynolds LE, Short C [2018b]. Progressive massive fibrosis in coal miners from 3 clinics in Virginia. *J Am Med Assoc* 319(5):500–501.
- CDC [2012]. Pneumoconiosis and advanced occupational lung disease among surface coal miners—16 states, 2010-2011. Centers for Disease Control and Prevention. *MMWR* 61(23):431–434.
- CDC [2016]. Resurgence of progressive massive fibrosis in coal miners—eastern Kentucky, 2016. Centers for Disease Control and Prevention. *MMWR* 65(49):1385–1389.
- CDC [2019]. Centers for Disease Control and Prevention, National Institute for Occupational Safety and Health, Occupational Respiratory Disease Surveillance, National Occupational Respiratory Mortality System (NORMS) National Database.
- CFR. Code of federal regulations. Washington, DC: U.S. Government Printing Office, Office of the Federal Register.
- DOL [2021]. U.S. Department of Labor, Office of Workers' Compensation Program, Division of Coal Mine Workers' Compensation (DCMWC), Black Lung Program Statistics, Black lung benefit payment totals by year.  
<https://www.dol.gov/owcp/dcmwc/statistics/TotalBenefitsPayment.htm>
- Hale JM [2021]. E-mail message from Janet Hale, Program Analyst, Respiratory Health Division, NIOSH, to Cara Halldin, January 29.
- Hall NB, Blackley DJ, Halldin CN, Laney AS [2019]. Continued increase in prevalence of r-type opacities among underground coal miners in the USA. *Occup Env Med* 76(7):479–481.
- Hall NB, Blackley DJ, Halldin CN, Laney AS [2020]. Pneumoconiosis progression patterns in U.S. coal miner participants of a job transfer programme designed to prevent progression of disease. *Occup Environ Med* 77(6):402–406.

- Halldin CN, Reed WR, Joy GJ, Colinet JF, Rider JP, Peterson EL, Abraham JL, Wolfe AL, Storey E, Laney AS [2015]. Debilitating lung disease among surface coal miners with no underground mining tenure. *J Env Occup Med* 57(1):62–67.
- Heaney PJ [1994]. Structure and chemistry of the low-pressure silica polymorphs. In: Heaney PJ, Prewitt CT, Gibbs GV, eds. *Silica: physical behavior, geochemistry, and materials applications. Reviews in mineralogy. Vol. 29.* Washington, DC: Mineralogical Society of America.
- Hessel PA, Sluis-Cremer GK, Hnizdo E, Faure MH, Thomas RG, Wiles FJ [1988]. Progression of silicosis in relation to silica dust exposure. *Ann Occup Hyg* 32(Suppl 1):689–696.
- Hnizdo E, Sluis-Cremer GK [1993]. Risk of silicosis in a cohort of white South African gold miners. *Am J Ind Med* 24:447–457.
- IARC [1997]. IARC monographs on the evaluation of carcinogenic risks to humans: Silica, some silicates, coal dust and para-aramid fibrils. Vol. 68. Lyon, France: World Health Organization, International Agency for Research on Cancer.
- IARC [2009]. Silica dust, crystalline, in the form of quartz or cristobalite. IARC monographs—100C, pp. 355–405. <https://monographs.iarc.fr/wp-content/uploads/2018/06/mono100C-14.pdf>
- ILO [2011]. Guidelines for the use of the ILO international classification of radiographs of pneumoconioses. Geneva, Switzerland: International Labour Office.
- Joy GJ [2012]. Evaluation of the approach to respirable quartz exposure control in U.S. coal mines. *J Occup Env Hyg* 9(2):65–68.
- Kreiss K, Zhen B [1996]. Risk of silicosis in a Colorado mining community. *Am J Ind Med* 30:529–539.
- Miller BG, Hagen S, Love RG, Soutar CA, Cowie HA, Kidd MW, Robertson A [1998]. Risks of silicosis in coalworkers exposed to unusual concentrations of respirable quartz. *Occup Env Med* 55:52–58.
- Ng TP, Chan SL, Lam KP [1987]. Radiological progression and lung function in silicosis: a ten year follow up study. *Br Med J* 295:164–168.
- NIOSH [1995]. Criteria for a recommended standard: occupational exposure to respirable coal mine dust. Cincinnati, OH: U.S. Department of Health and Human Services, Centers for Disease Control and Prevention, National Institute for Occupational Safety and Health, DHHS (NIOSH) Publication No. 95-106.
- NIOSH [2002]. NIOSH hazard review: health effects of occupational exposure to respirable crystalline silica. Cincinnati, OH: U.S. Department of Health and Human Services, Centers for Disease Control and Prevention, National Institute for Occupational Safety and Health, DHHS (NIOSH) Publication No. 2002-129.
- NIOSH [2019a]. Coal Workers' Health Surveillance Program. U.S. Department of Health and Human Services, Centers for Disease Control and Prevention, National Institute for Occupational Safety and Health, <https://www.cdc.gov/niosh/topics/cwhsp/default.html>
- NIOSH [2019b]. Coal Workers' Health Surveillance Program (CWHSP) Data Query System. Centers for Disease Control and Prevention, National Institute for Occupational Safety and

Health, Respiratory Health Division, Surveillance Branch, <https://webappa.cdc.gov/ords/cwhsp-database.html>

Parker JE, Wagner GR [1998]. Silicosis. In: Stellman JM, ed. *Encyclopaedia of occupational health and safety*. 4th ed. Geneva, Switzerland: International Labour Office, pp. 10.43–10.46.

Peters JM [1986]. Silicosis. In: Merchant JA, Boehlecke BA, Taylor G, Pickett-Harner M, eds. *Occupational respiratory diseases*. Cincinnati, OH: U.S. Department of Health and Human Services, Centers for Disease Control, National Institute for Occupational Safety and Health, DHHS (NIOSH) Publication No. 86–102, pp. 219–237.

Reynolds L, Halldin CN, Laney AS, Blackley DJ [2018a]. Coal miner participation in a job transfer program designed to prevent progression of pneumoconiosis, United States, 1986–2016. *Arch Env Occup Health* 73(6):344–346.

Reynolds LE, Blackley DJ, Colinet JF, Potts JD, Storey E, Short C, Carson R, Clark KA, Laney AS, Halldin CN [2018b]. Work practices and respiratory health status of Appalachian coal miners with progressive massive fibrosis. *J Occup Env Med* 60(11):e575–e581.

Ruckley VA, Fernie JM, Chapman JS, Collings P, Davis JMG, Douglas AN, Lamb D, Seaton A [1984]. Comparison of radiographic appearances with associated pathology and lung dust content in a group of coal workers. *Brit J Ind Med* 41(4):459–467.

Soutar CA, Collins HPR [1984]. Classification of progressive massive fibrosis of coalminers by type of radiographic appearance. *Brit J Ind Med* 41(3):334–339.

USBM [1992a]. Crystalline silica overview: occurrence and analysis. By Ampian SG, Virta RL. Washington, DC: U.S. Department of the Interior, Bureau of Mines, IC 9317. NTIS No. PB92-200997.

USBM [1992b]. Crystalline silica primer. Washington, DC: U.S. Department of the Interior, Bureau of Mines, Branch of Industrial Minerals, Special Publication (SP) 05-92. NTIS No. PB97-120976.

Virta RL [1993]. Crystalline silica: what it is—and isn't. *Minerals Today* Oct:12–16. Washington, DC: U.S. Department of the Interior, Bureau of Mines.

Wagner GR [1994]. Mineral dusts. In: Rosenstock L, Cullen MR, eds. *Textbook of Clinical Occupational and Environmental Medicine*. Philadelphia, PA: W.B. Saunders Co., pp. 825–837.

Weber SL, Banks DE [1994]. Silicosis. In: Rosenstock L, Cullen MR, eds. *Textbook of Clinical Occupational and Environmental Medicine*. Philadelphia, PA: W.B. Saunders Co., pp. 264–274.

## CHAPTER 2: SAMPLING TO QUANTIFY RESPIRABLE DUST GENERATION

The respirable fraction of airborne mine dust is the dust that reaches the gas exchange region of the lungs and can lead to the development of coal workers' pneumoconiosis (CWP) or silicosis. The American Conference of Governmental Industrial Hygienists (ACGIH) and the International Organization for Standardization (ISO) have adopted airborne particulate sampling conventions for use in assessing possible health effects [ACGIH 1994; ISO 1995]. The respirable fraction is currently defined by the size distribution shown in Table 2.1, representing dust with aerodynamic diameters of less than 10 micrometers ( $\mu\text{m}$ ) with a 50% cut point of 4  $\mu\text{m}$ . Aerodynamic diameter is defined as the diameter of a hypothetical sphere of 1 gram per cubic centimeter density having the same settling velocity in calm air as the particle in question, regardless of the particle's geometric size, shape, and true density. This size distribution was selected as being representative of particle deposition within the alveolar region of the human respiratory tract [NIOSH 1995].

**Table 2.1. ACGIH/ISO size distribution definition of respirable dust [ACGIH 1994; ISO 1995]**

<b>Particle aerodynamic diameter (<math>\mu\text{m}</math>)</b>	<b>Respirable particulate mass collected (%)</b>
0	100
1	97
2	91
3	74
4	50
5	30
6	17
7	9
8	5
10	1

Individual respirable dust particles cannot be seen with the eye. Conversely, if a dust cloud is visible, it is likely that a portion of the airborne dust will be in the respirable size range. To accurately quantify the amount of potentially harmful respirable dust in the mine air, sampling instrumentation must be used. Accurate respirable dust sampling is important to quantify worker exposures, identify dust sources, and evaluate the effectiveness of control technologies.

## Respirable Dust Samplers Used in Coal Mining

Electrical equipment intended for use at the mining face in underground coal operations must be certified by the Approval and Certification Center of the Mine Safety and Health Administration (MSHA). Testing is conducted by MSHA to ensure safe operation of this equipment in the methane gas environment found in underground mines [MSHA 2019a]. At the time of publication, only three respirable dust sampling instruments were certified for use in underground coal mines by MSHA: a gravimetric sampler, a continuous personal dust monitor, and a light-scattering instrument. All of these samplers can be worn by miners to quantify personal exposures or can be placed at specific locations to quantify area dust levels. Each of these instruments can provide unique information that can help mine operators assess dust sources, control technology effectiveness, and personal dust exposures.

In addition to these respirable dust sampling instruments, NIOSH has also developed a field-based method that can be utilized at the mine site to provide mine operators information on the respirable silica content of gravimetric samples immediately after sampling has been completed. A discussion for each of these respirable dust samplers and the silica analysis method follows. Also, NIOSH has adapted an inhalable dust sampler and the continuous personal dust monitor to collect airborne samples of float dust. These samplers are discussed in Chapter 6.

### Gravimetric Sampler

The Federal Coal Mine Health and Safety Act of 1969 (Public Law 91-173) required respirable dust concentrations to be measured with a four-channel horizontal elutriator dust sampler developed by the Mining Research Establishment (MRE) of the National Coal Board, London, England, or “MRE-equivalent” concentrations measured with samplers approved by the Secretary of Health, Education, and Welfare. In 1970, a personal gravimetric respirable dust sampler was approved for use in the U.S. mining industry and was worn by miners as shown in the left photo of Figure 2.1. This type of sampler was used by both the mine operators and MSHA inspectors to collect all compliance samples until MSHA passed a new dust rule in 2014 [79 Fed. Reg.<sup>10</sup> 24814 (2014)]. Beginning on February 1, 2016, the 2014 dust rule required underground coal mine operators to use a continuous personal dust monitor (CPDM) to complete compliance dust sampling. However, under the new dust rule, the gravimetric sampler is still being used for compliance sampling by surface coal mine operators, for compliance sampling by MSHA inspectors including analyzing the samples for silica content, and for area samples at underground coal mines.

The main components of the gravimetric sampling system consist of a size-selective cyclone, a filter cassette, and a constant-flow sampling pump [Zefon International 2019a] as shown in Figure 2.1, right. The 10-millimeter (mm) Dorr-Oliver cyclone separates the oversize dust from the respirable fraction. The oversize dust is deposited into the grit pot at the bottom of the cyclone, while the respirable fraction is collected on a 37-mm-diameter polyvinyl chloride (PVC) filter. The cyclone and filter are placed in a metal holder equipped with an alligator clip to attach the holder to the lapel area when worn by a miner. The filter should be weighed by a qualified lab to determine the mass of respirable dust that has been collected during sampling. Care must be taken after a sample is collected to ensure that the cyclone assembly stays in an

---

<sup>10</sup> Federal Register. See Fed. Reg. in references.



upright position. Otherwise, the oversize dust particles in the grit pot can fall through the cyclone body and be deposited onto the filter, invalidating the sample.

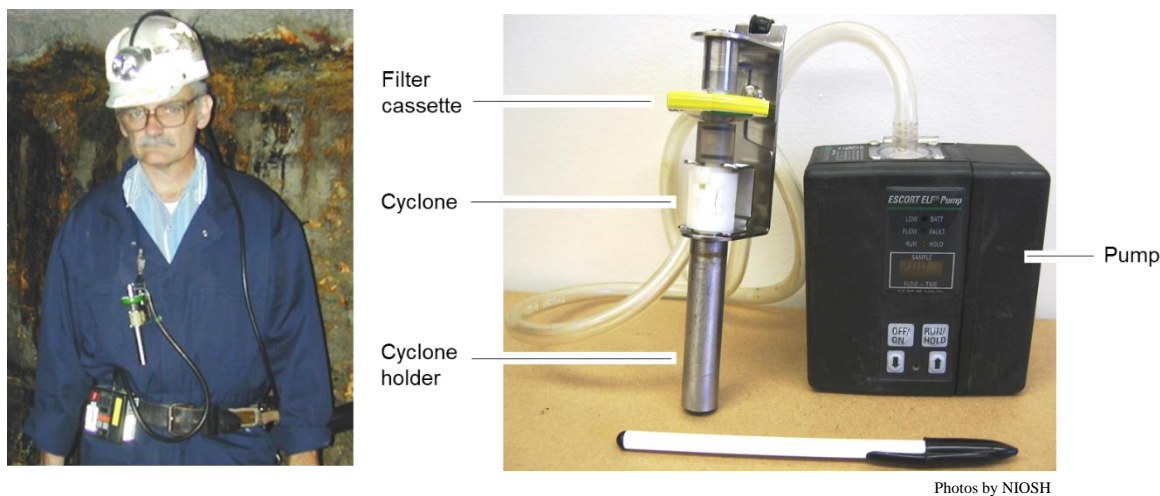

**Figure 2.1. Miner wearing gravimetric sampler (left) and sampling system components (right).**

The sampling pump alternately displays the flow rate and operating time while running, with sampling time displayed after the pump is turned off. The flow rate and sampling time are used to calculate the total volume of air sampled. The mass of dust collected on the filter and the volume of air sampled are used to calculate the average concentration of respirable dust in milligrams per cubic meter ( $\text{mg}/\text{m}^3$ ) over the entire sampling period.

For coal mining operations, the sampling pump is calibrated to operate at 2 liters per minute (L/min). At this flow rate, the Dorr-Oliver cyclone collects a respirable dust fraction that more closely matches the U.S. Atomic Energy Commission definition of respirable dust [USBM 1970; Sansone et al. 1973], which has a 50% cut point of  $3.5 \mu\text{m}$ . It was determined that multiplying the calculated dust concentration at the 2 L/min flow rate by an empirically derived constant factor of 1.38 [USBM 1973] provides an MRE-equivalent dust concentration as required by the 1969 Act.<sup>11</sup>

A benefit of using the gravimetric sampler is that the PVC filter can be analyzed to determine the silica content in the collected dust. At the time of publication, this is the only way to determine the silica content for compliance purposes. After a dust sample is collected, the filter cassette is sent to the MSHA Dust Division analytical laboratory in Pittsburgh, PA. For samples collected in coal mines, the MSHA P-7 infrared analytical technique [Parobeck and Tomb 2000] is used to determine silica content.<sup>12</sup> For samples collected by mines for their own information on silica content, filter samples should be sent to an accredited laboratory for analysis. Alternatively, coal

---

<sup>11</sup> There is no regulation for samples collected in metal and nonmetal mines to be MRE-equivalent. In metal and nonmetal mining operations, the gravimetric sampling pump is operated at 1.7 L/min. Research has shown [Bartley et al. 1994] that at 1.7 L/min the Dorr-Oliver cyclone results in dust collection that more closely matches the ACGIH/ISO definition of respirable dust shown in Table 2.1.

<sup>12</sup> In metal and nonmetal mines, additional minerals are present that can complicate the silica analysis. As a result, x-ray diffraction using NIOSH Method 7500 [NIOSH 2003] can better identify these confounding materials and is used to analyze samples from metal and nonmetal mines.

mine operators can now conduct their own on-site analysis using a field-based technique developed by NIOSH, which is discussed later in this chapter.

A great number of variables are encountered in mining operations that can impact airborne dust levels and create significant dust gradients [Kissell and Sacks 2002]. Consequently, when sampling to quantify dust sources and for evaluating control technologies, it is desirable to place multiple gravimetric samplers at a single location and calculate an average dust concentration. The use of multiple samplers increases the confidence that the measured dust levels are representative of the true dust concentration at that location.

### Continuous Personal Dust Monitor

Through external contracts and associated internal research, NIOSH developed a compliance-grade personal dust monitor (PDM) that provides near real-time respirable dust exposure information to the miner during the shift and the average shift concentration immediately at the end of sampling [NIOSH 2006]. This sampler was certified by NIOSH in 2014 as meeting the performance criteria of a continuous personal dust monitor (CPDM) as specified in the Code of Federal Regulations (CFR) [30 CFR Part 74 Subpart C]. MSHA also approved the sampler as being intrinsically safe. The commercial version of this sampler is available from Thermo Fisher Scientific as the PDM3700 Personal Dust Monitor [Thermo Fisher Scientific 2019a] as shown in Figure 2.2, left. Beginning on February 1, 2016, underground coal mine operators have had to use a CPDM to obtain compliance dust samples on specified occupations.

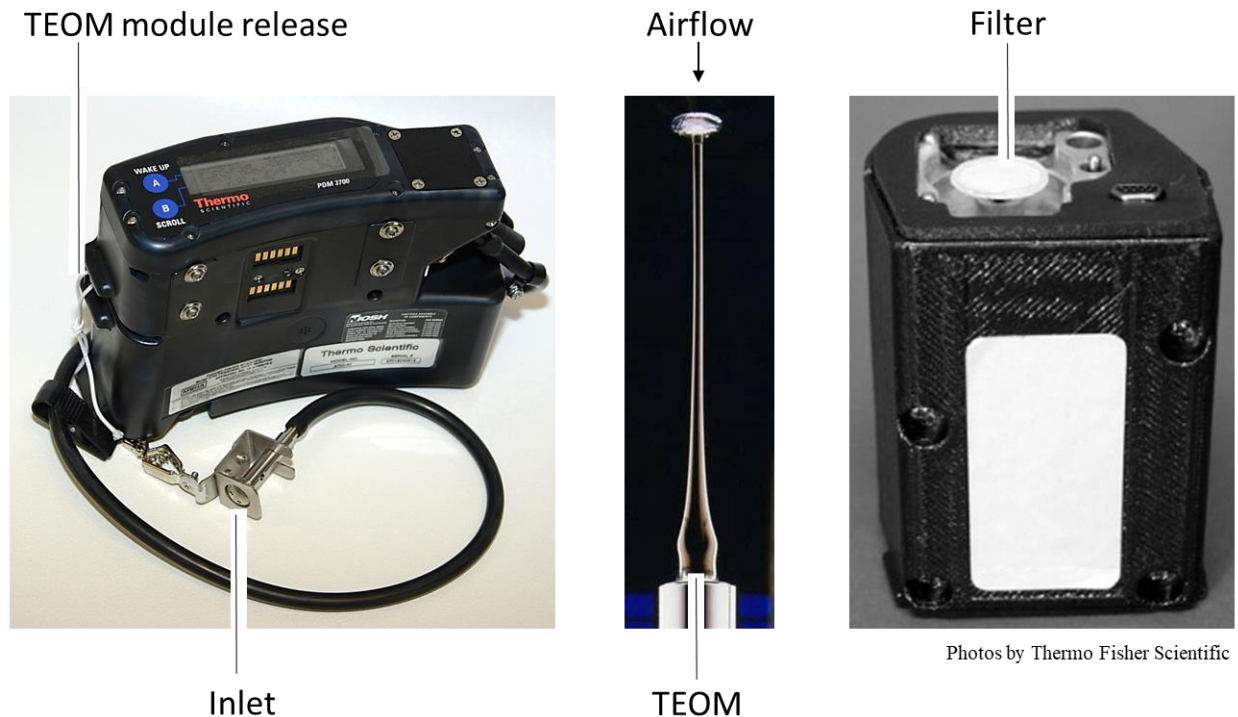

Figure 2.2. PDM3700 sampler (left), TEOM (center), and TEOM module removed from PDM (right).

The PDM uses tapered-element oscillating microbalance (TEOM) technology to obtain a gravimetric-based measure of respirable dust concentrations. The TEOM is a hollow tube with a filter mounted on top (Figure 2.2, center) that vibrates at a known frequency. As dust-laden air is

drawn through the filter and tube, respirable dust is collected on the filter resulting in a change in TEOM frequency, which is directly correlated to the added dust mass. The TEOM and a section of airflow tubing inside the PDM leading to the TEOM are equipped with heaters. This heated flow path is designed to remove moisture from the collected dust [NIOSH 2006]. The added dust mass and the volume of sampled airflow are used to calculate a respirable dust concentration which is recorded each minute by the PDM for later download. Within the PDM, the TEOM is mounted in an independent module (Figure 2.2, right) that is removed from the instrument to change the filter.

The PDM is equipped with a lapel-style inlet to capture dust in a similar location as the gravimetric sampler. A Higgins-Dewell cyclone is mounted on the instrument and separates the respirable fraction of airborne dust. When operated at 2.2 L/min, the Higgins-Dewell cyclone has been shown [Bartley et al. 1994] to collect a sample distribution best matching the ISO definition of respirable dust as defined in Table 2.1. The actual dust concentration calculated by the PDM is multiplied by 1.05 to match the MRE-equivalent dust concentrations as measured with the gravimetric sampler [Page et al. 2008]. This MRE factor is the default setting in the PDM software but can be turned off if the PDM is going to be used for non-compliance sampling.

A key benefit of the PDM is the information provided to the wearer during the sampling shift which can be used to prevent overexposures from occurring. The PDM is equipped with a readout where wearer can scroll through several different screens of information to assess their dust exposure. The first screen (Figure 2.3, left) shows the dust concentration over the previous 30 minutes and the cumulative dust concentration to that point in the shift. The second screen (Figure 2.3, center) shows the permissible exposure limit (PEL) and the percentage of the PEL that has been reached to that point in the shift. The PDM programming software defaults to a PEL of 1.5 mg/m<sup>3</sup> to match the dust standard defined in the 2014 MSHA dust rule. However, if a mining section is operating on a reduced dust standard due to elevated quartz, the reduced dust standard can be entered into the PDM when programming for the shift's sampling run. The last screen (Figure 2.3, right) shows a bar chart of dust levels throughout the shift with each bar representing a 30-minute time period, which can be reviewed to identify the highest exposure periods during the shift. The information on these screens can be used by the wearer to monitor dust exposure throughout the shift and assess the potential for a dust overexposure. For example, if the PEL reached on the second screen shows 50% and the shift is only two hours into a 10-hour shift, it would indicate that a dust overexposure is going to occur if no changes to the control technologies and/or operating procedures are made.



Photos by NIOSH

**Figure 2.3. Information displayed on a PDM3700. The first PDM screen shows 30-minute and cumulative concentration (left), the second screen shows shift limit and percentage of limit (center), and the third screen shows a bar chart of 30-minute averages (right).**

When the PDM completes its sampling run, the average shift concentration is displayed on the instrument screen and also stored internally with the shift data. Therefore, the mine will immediately know the average respirable dust concentration for the sampling shift.

The PDM is currently configured to store two data files. One file is encrypted and must be transmitted to MSHA as the official record of compliance sampling. The second file can be downloaded and the recorded data can be reviewed by the mine operator to identify periods of elevated dusts concentrations or other periods of interest.

Another benefit provided by the PDM is that it monitors and records numerous operating parameters to confirm that the instrument is functioning properly. A few examples of operating parameters that are monitored include the mass gain/loss on the filter, airflow rate, and TEOM temperature control. If one of the operating parameters extends beyond its defined range that is incorporated into the operating software, the PDM generates a status code that identifies the operating parameter that is out-of-range and the time of occurrence. The status code is recorded in the data file and an “S” is displayed on the readout screen to alert the wearer [Thermo Fisher Scientific 2019b]. For example, if the sampler inlet is accidentally pulled from the miner’s lapel and the inlet drops into a pile of dust, a large mass gain on the filter would be registered and would trigger generation of a “Mass Offset” status code. MSHA uses a number of these status codes [MSHA 2019b] to help determine if a compliance sample should be voided.

### Light-scattering Real-time Dust Monitor

In addition to the gravimetric samplers, a real-time dust sampler had been approved by MSHA for use in underground mines but was not certified by NIOSH for compliance sampling purposes. However, a number of electronic components in the original design are no longer available; therefore, new MSHA-approved units are not available at the time of publication. Previously approved units can still be used in underground coal mines. Also, Thermo is pursuing MSHA approval for the modified instrument with updated electronics [Gallagher 2021].

The personal DataRAM 1000 AN (pDR) [Thermo Fisher Scientific 2019c] is a passive sampler (Figure 2.4, left) that has dust-laden air enter a sensing chamber where a light beam passes through the dust. A sensor measures the amount of light scatter caused by the dust and relates this scatter to a relative dust concentration. This concentration is correlated to the time when the sample was measured and is stored in the internal data logger. The data logging averaging period is user-selected and ranges from one second to one hour. The sample data can then be downloaded to a computer for analysis.



Photos by NIOSH

**Figure 2.4. pDR 1000AN sampler (left) and pDR operated with gravimetric samplers in an underground coal mine (right).**

Unfortunately, the accuracy of the light-scattering monitors can be compromised by dust clouds with changing size distributions, different dust compositions, and/or water mist in the air. Consequently, when NIOSH uses pDR samplers, a field calibration is completed as recommended by the manufacturer [Thermo Scientific 2013]. Gravimetric samplers are operated adjacent to the pDR as shown in Figure 2.4, right. Individual pDR dust measurements are adjusted based on the ratio between the average gravimetric concentration and the average pDR concentration. For example, if the average gravimetric concentration was  $1.2 \text{ mg/m}^3$  over a 6-hour measurement period and the pDR average concentration was  $0.9 \text{ mg/m}^3$  for the same 6 hours, then all individual pDR measurements would be multiplied by 1.33 ( $1.2 \div 0.9$ ).

Figure 2.5 illustrates a graph generated from data obtained with the pDR. Mobile sampling (this sampling technique is discussed later in the chapter) was used to collect the data on a producing longwall face. The time-related dust data can be analyzed for specific time intervals (e.g., head-to-tail and tail-to-head passes on the longwall), with average dust concentrations calculated for each of these intervals.

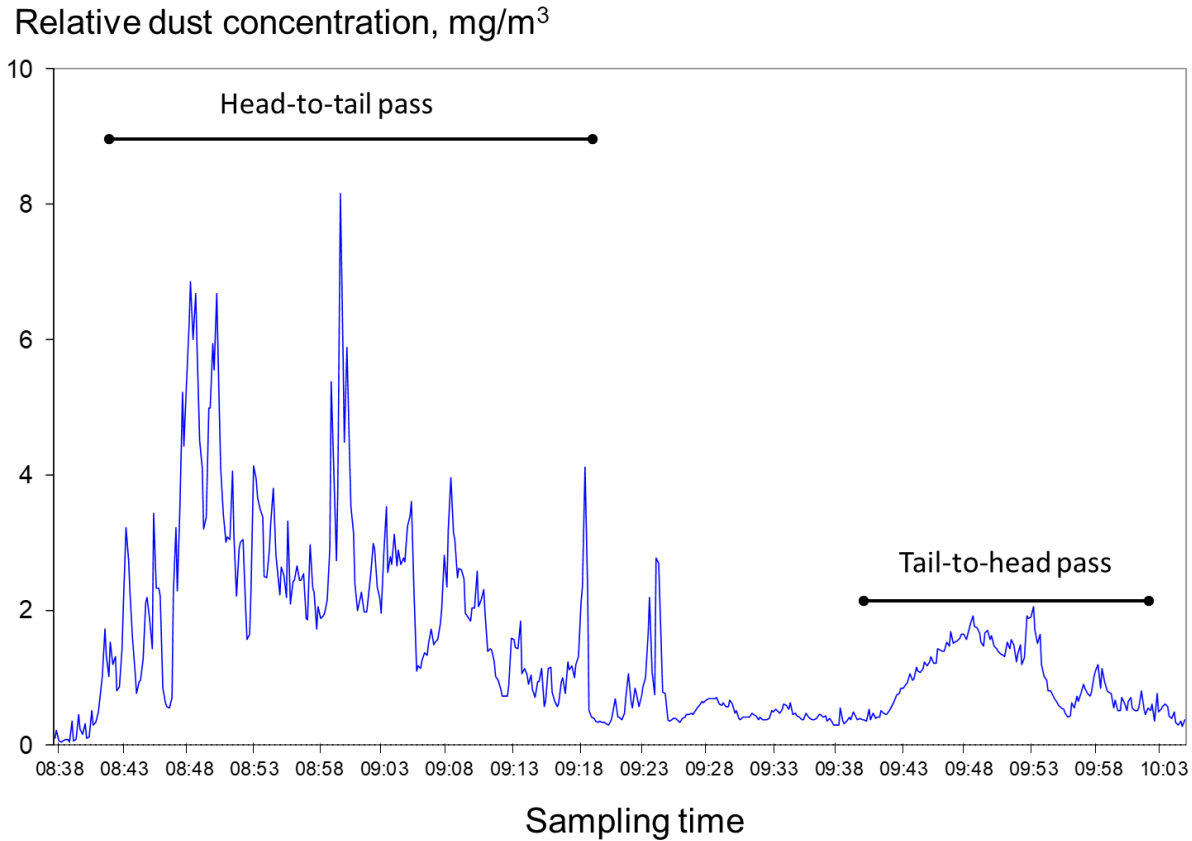

**Figure 2.5. Dust measurements obtained with the pDR near the shearer on a longwall face.**

A benefit of using the pDR is that data for short-term dust events can be collected and analyzed when the data is downloaded. This capability is particularly useful when trying to quantify dust levels for events that last a relatively short period of time. Examples of short-term events of interest in an underground coal mine may be the dust exposure for shuttle car operators while being loaded by the continuous miner or roof bolter operators cleaning their dust boxes. These types of activities can last less than one minute, but by selecting an appropriate logging time such as one to two seconds, many data points can still be obtained. Short-term dust spikes occurring during these events would also be identified with this sampling frequency, as shown in Figure 2.5 where a spike reaches over 8 mg/m<sup>3</sup>.

### Field-based Silica Analysis

Historically, the MSHA P-7 infrared analytical method has been used to quantify the respirable crystalline silica content of gravimetric samples collected at coal mining operations for compliance determination and continues to be used [MSHA 2018]. This method quantifies the alpha quartz in the sample, which is the most common of the crystalline silica polymorphs. After being received at the MSHA’s Dust Division laboratory, a filter is removed from its sampling cassette and ashed in a low-temperature, radio frequency ashers. This procedure removes the organic coal dust and filter material. The remaining material is redeposited onto a new filter for scanning with a Fourier transform infrared (FTIR) spectrometer to determine the quartz content. It can take one week or more from the time the dust sample is initially collected at a mine to

when the mine is provided with the silica results. If mining conditions present when the sample was collected have not changed, then silica overexposures could continue to occur during the interim until the mine is notified of the elevated silica levels.

To address this time delay in obtaining silica analysis results, NIOSH has developed a field-based method that utilizes a portable FTIR instrument to analyze gravimetric filters at the mine site with no sample preparation needed [Cauda et al. 2016; Pampera et al. 2019; NIOSH forthcoming]. It should be noted that this method is not intended to be used for compliance determination. Four commercially available FTIR instruments (Figure 2.6) were used in initial NIOSH testing, with all units performing satisfactorily [Ashley et al. 2020].



Photo by NIOSH

**Figure 2.6. Portable FTIR units used in NIOSH testing: Thermo Fisher (top left), Perkin Elmer (top right), Bruker Optics (bottom right), and Agilent manufacturers (bottom left).**

Initially, the field-based method was developed by utilizing samples collected with the non-regulated coal dust sampling cassette [Zefon International 2019b], which is not the tamper-proof cassette used for compliance sampling. The filter capsule was removed from its plastic cassette holder and inserted into a portable FTIR unit for analysis. NIOSH-developed software known as Field Analysis of Silica Tool (FAST) [NIOSH 2019a] takes the output from the FTIR instrument and calculates the quartz content in terms of mass concentration. In approximately three minutes, the quartz content is known. If elevated silica is present, mine personnel can use this knowledge to take action on the next shift in an effort to prevent additional silica overexposures.

To improve accuracy and facilitate filter handling, NIOSH worked with a filter manufacturer [Zefon International 2019c] to design a new four-piece cassette (Figure 2.7, left) for obtaining a gravimetric sample. By using this cassette, the dust deposition is more uniformly distributed

across the filter. This improves the accuracy of the silica analysis, since only the center of the filter is analyzed by the FTIR. Also, the filter remains encased within the two center sections of the cassette (Figure 2.7, center), and this entire section is placed in the FTIR analyzer (Figure 2.7, right). This significantly reduces handling of the filter—thus minimizing the potential for disturbing the deposited dust.

NIOSH has also designed specific filter cassette cradles for use in the portable FTIR instruments which align the cassette for analysis. A 3-D printer can be used to produce these cradles, and NIOSH has made the design files for 3-D printing available on a government website [NIH 2020]. Additional information on the hardware and software requirements for using this field-based respirable crystalline silica monitoring method is available on the NIOSH website [NIOSH 2019b].



Photos by NIOSH

**Figure 2.7. Four-piece cassette (left) with filter contained within two center sections (center) and being loaded into an FTIR instrument cradle (right).**

Because this method is non-destructive, the filter cassette can then be sent to a laboratory for traditional P-7 analysis for comparison to results obtained from the field-based method. Initial NIOSH research compared results from the portable FTIR and the MSHA P-7 method, as shown in Figure 2.8 [Miller et al. 2012]. The accuracy observed for these laboratory-generated samples provided the confidence to move forward with further development and testing of the field-based method for coal mines.

It should be noted that the array of minerals found in dust samples collected in metal and nonmetal mines adds complexity to the analysis and is still being researched by NIOSH. Also, it is worth noting again that the original goal was to develop a method that could be easily used by mine operators to evaluate trends in silica levels and determine the relative effectiveness of implemented control technologies. At this time, this method is not intended to be used for determining compliance with MSHA dust limits.



## Portable FTIR silica mass, $\mu\text{g}$

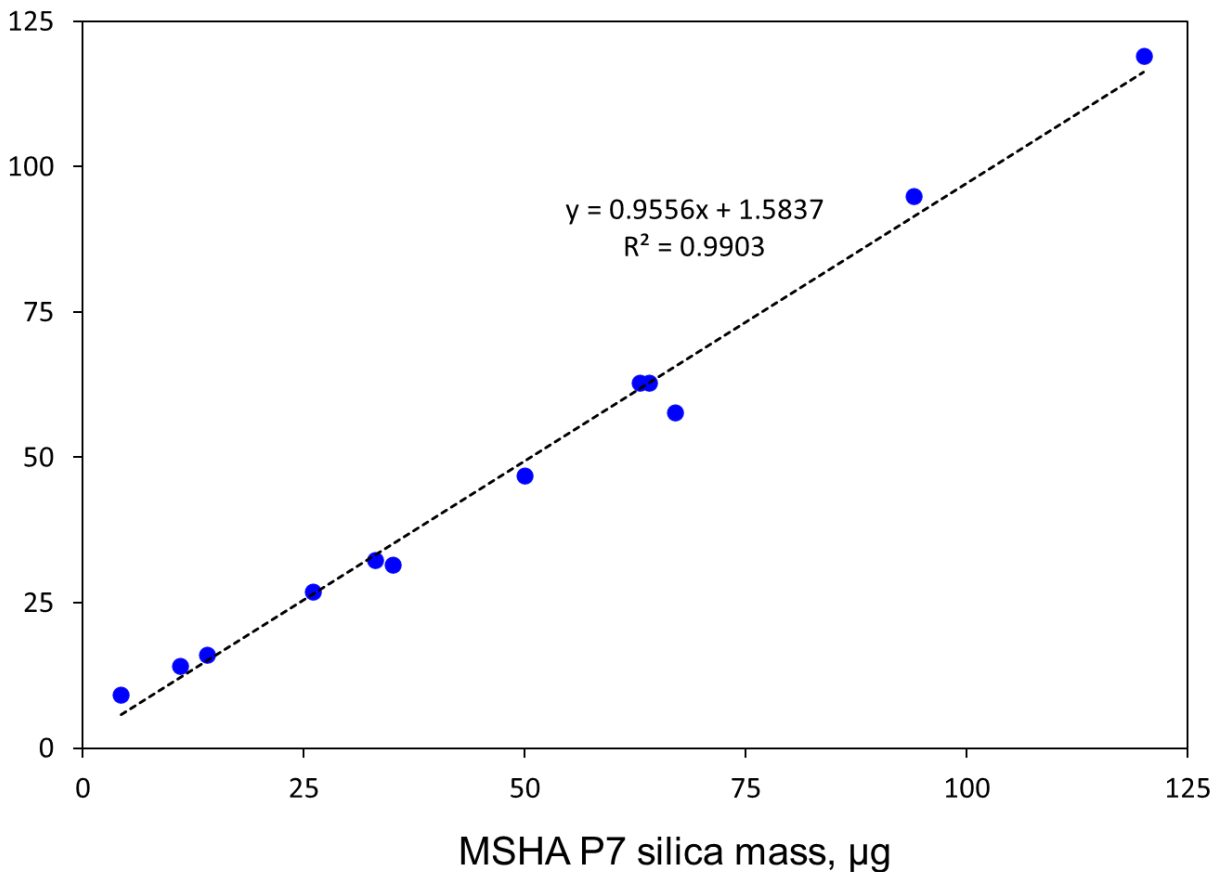

**Figure 2.8. Comparison of results obtained with portable FTIR and P7 silica analysis techniques.**

## Sampling Strategies

To effectively control the respirable coal and silica dust exposure of mine workers, it is necessary to identify the sources of dust generation and quantify the amount of dust liberated by each of these sources. After the dust sources have been quantified, dust control technologies can then be applied that offer the greatest protection to the mine workers.

To quantify the amount of dust liberated by a source, dust sampling must be conducted in a manner that isolates the identified dust-generating source. This is achieved by placing dust samplers upwind and downwind of the source in question. The difference between these measurements is used to calculate the quantity of dust liberated by this source.

For example, in an underground coal mine working face, samplers can be placed in the immediate intake and return of the continuous miner to determine the amount of dust liberated by the miner while cutting and loading in the face. In this case, samplers are positioned upwind and downwind of the miner to sample the airborne dust levels throughout the cut. Figure 2.9, left, shows these sampling locations for a continuous miner while using exhausting ventilation in the face. Figure 2.9, right, shows a sampling package containing two gravimetric samplers and a pDR hung in the intake air to the miner.

If gravimetric samplers are used for this evaluation, it is necessary to ensure that sufficient mass is collected during sampling. As a result, it may be necessary to sample during multiple continuous miner cuts. In this case, the sampling pumps should be started when the continuous miner has been positioned in the face and begins cutting coal. After the first cut has been completed, the sampling pumps should be placed on hold to suspend sampling while the miner is repositioning into the next face. While on hold, the sampling pumps should be repositioned to the second cut in the same relative locations as for the first cut sampled. When the miner is ready to resume mining, the sampling pumps can be restarted.

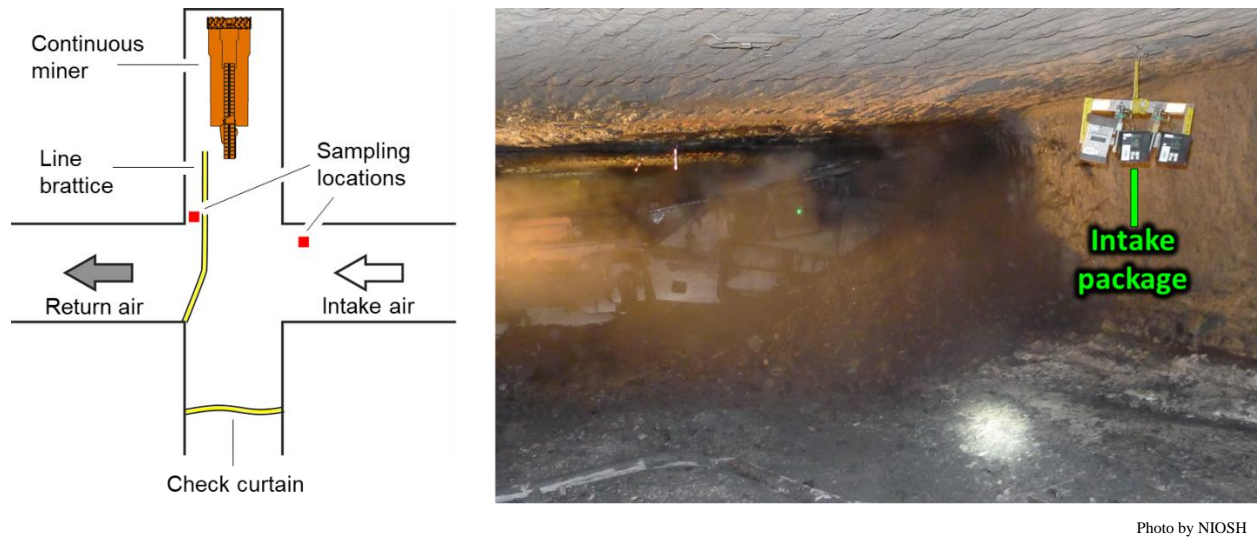
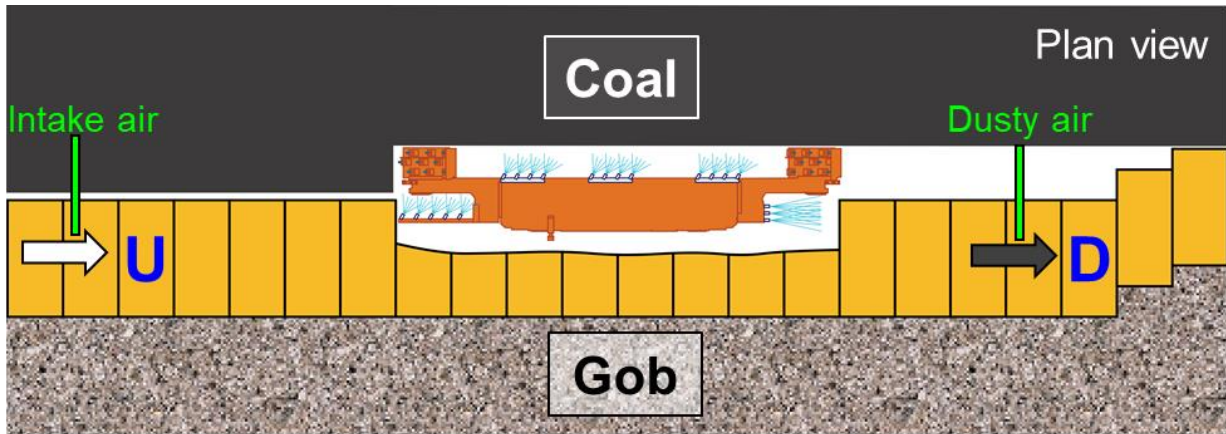

Photo by NIOSH

**Figure 2.9. Sampling locations used to isolate dust generated by a continuous miner (left) and sampling package positioned in intake air to the miner (right).**

For a more mobile piece of equipment, such as a longwall shearer, a mobile sampling strategy must be used to isolate the dust generated by the equipment as it cuts coal. Two sampling personnel would be required to travel with the shearer as it mines across the longwall face, Figure 2.10. One person would be located upwind of the shearer while the second would be located downwind. These sampling personnel would maintain their respective distances from the shearer as it mines across the face. Figure 2.11, left, shows a NIOSH researcher wearing gravimetric sampling pumps and carrying a pDR as he travels with the shearer across the face. It should be noted that some mines prohibit personnel from going completely downwind of the shearer, so the downwind sampler may need to be positioned near the tailgate shearer operator or jacksetter.



Mobile sampling locations: U = upwind, D = downwind

**Figure 2.10. Mobile sampling used to quantify dust generated by the shearer as it completes a tailgate-to-headgate cut across the longwall face.**

As was discussed for continuous miner operations, stationary sampling packages can also be used on longwall faces to isolate and quantify dust sources, such as from the stageloader-crusher unit. Coal leaving the longwall face at the headgate passes through a crusher and is then carried by the stageloader to the section conveyor belt for transport out of the mine. The stageloader and crusher are connected and viewed as one potential dust source. For U.S. longwalls, the shields are numbered consecutively down the face with the number 1 shield located in the headgate entry. Figure 2.11, right, shows a sampling package hung at shield 10, which quantifies the amount of dust in the intake air coming onto the longwall face. Dust levels from similar sampling packages located in the intake and belt entry can be subtracted from dust levels at shield 10 to determine the amount of dust being generated by the stageloader-crusher unit.

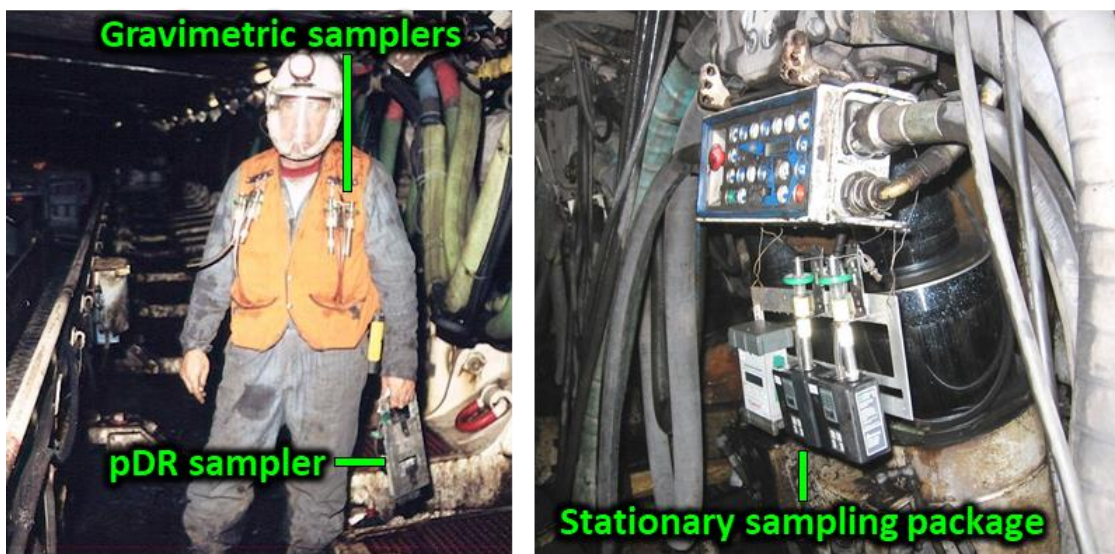

Photos by NIOSH

**Figure 2.11. NIOSH researcher conducting mobile sampling by tracking the shearer across the face while wearing gravimetric samplers and carrying a pDR (left) and a stationary sampling package hung on shield 10 (right).**

If an operator is positioned on a mobile piece of equipment such as a shuttle car or scoop and the dust exposure within the operator's compartment is desired, dust sampling instrumentation can be placed inside the compartment. Light-scattering instruments in conjunction with gravimetric samplers for correction, as shown in Figure 2.12, can be used to identify different periods of exposure. However, to identify the different exposure periods, the dust data would need to be augmented with time study information to isolate the activities and location of the equipment during these activities.

As an example, to assess the dust exposure during the load-haul-dump cycle of the shuttle car, it would be necessary to position someone near the continuous miner to track when the car is being loaded and also at the feeder-breaker to track when the car is dumping. The tram times would be the difference in time between leaving the miner/feeder and arriving at the other location.

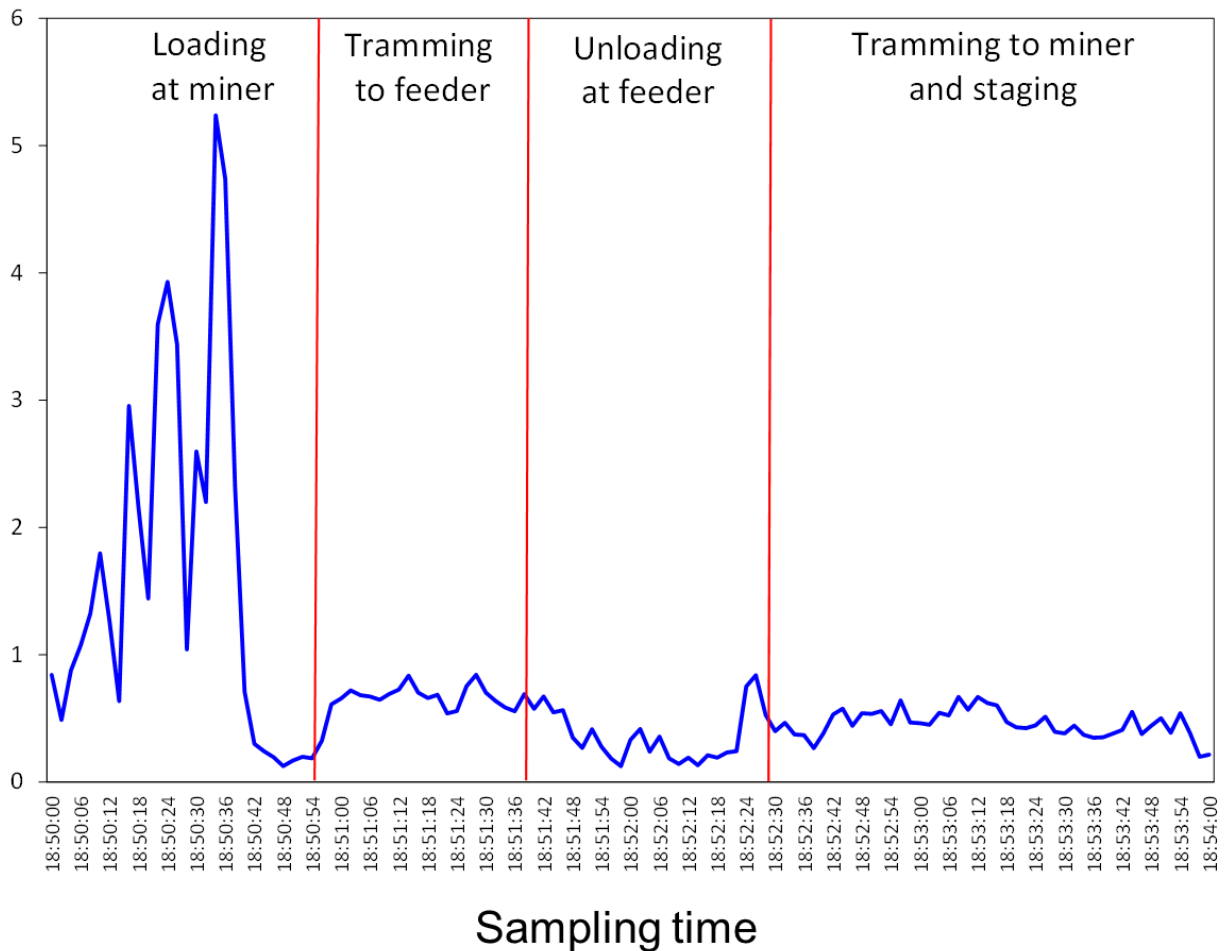

Photo by NIOSH

**Figure 2.12. Sampling package hung in cab on shuttle car.**

Figure 2.13 illustrates the dust levels NIOSH observed for one load-haul-dump cycle with a sampling package placed just in by the operator's cab, with a 2-second sampling interval selected for the pDR. Although loading behind the miner only lasted for 44 seconds, the short sampling interval allows for adequate data collection, as illustrated by the dust spikes occurring during loading.

pDR dust concentration, mg/m<sup>3</sup>



**Figure 2.13. Graph illustrating dust concentrations for different segments of a shuttle car load-haul-dump cycle.**

These sampling examples represent underground coal mines where a well-defined ventilation pattern is typically present. However, this is not always the case. For example, to quantify the amount of respirable dust generated by a drill at a surface mine, it would be necessary to place an array of samplers around the drill to account for dust liberated during changing wind directions. The dust concentrations from these samplers would be averaged to quantify dust liberation around the drill. It would also be necessary to place a background dust sampler far enough away from the drill, so that it is not impacted by drill dust, to monitor ambient dust levels approaching the drill. The dust levels from the ambient sample would be subtracted from the drill samples that have been averaged to determine the dust liberated by the drill. Figure 2.14, left, shows a schematic of sampling locations around a surface drill and a photo of a sampling stand positioned next to the drill table (right).

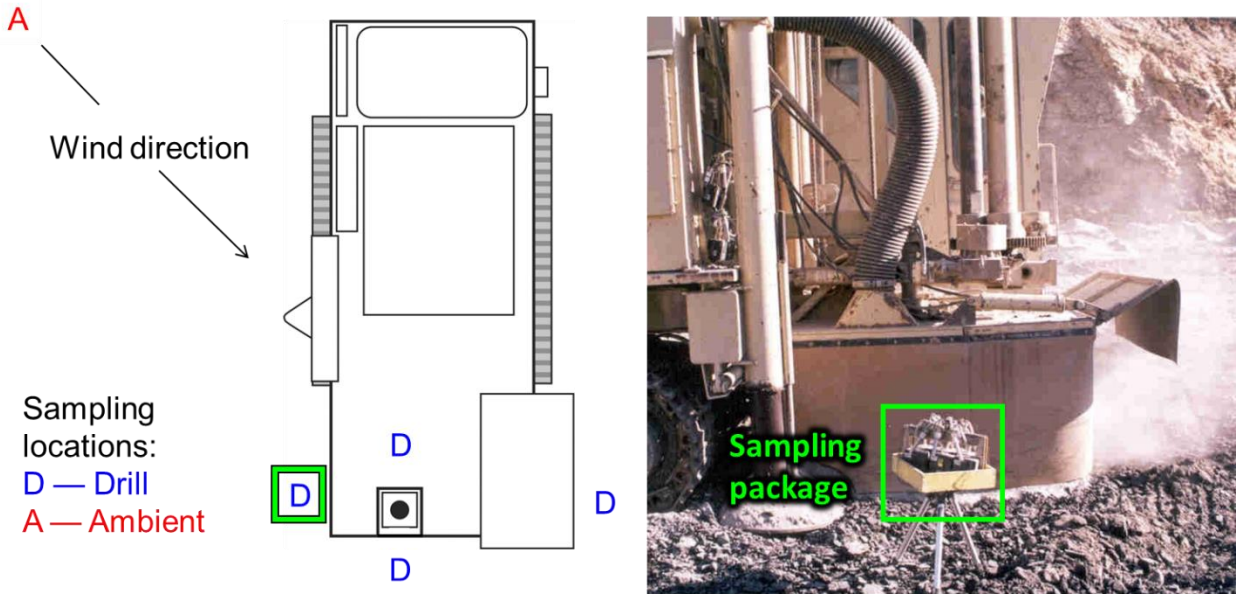

Photo by NIOSH

**Figure 2.14. Sampling locations around a surface drill (left) and a gravimetric sampling package positioned near the drill table (right).**

After identifying and quantifying the most significant dust sources, appropriate dust controls should be selected and implemented. To determine the impact of the added controls, sampling would once again be conducted. Typically, an A-B comparison would be needed to quantify the impact of added control technologies. The A-portion of the sampling would be conducted with the original operating conditions to establish baseline dust levels. The control technology of interest would then be installed, and the B-portion of the testing completed. To maximize the validity of the test results, both portions of the testing should be completed under similar operating conditions. The dust levels measured under each test condition would be compared to quantify the effectiveness of the installed control.

## References for Chapter 2

- 79 Fed. Reg. 24814 [2014]. Mine Safety and Health Administration: Lowering miners' exposure to respirable coal mine dust, including continuous personal dust monitors; final rule. (To be codified at 30 CFR 70, 71, 72, 75, and 90.)
- ACGIH [1994]. Threshold limit values for chemical substances and physical agents & biological exposure indices. Cincinnati, OH: American Conference of Governmental Industrial Hygienists.
- Ashley EL, Cauda EG, Chubb LG, Tuchman DP, Rubenstein EN [2020]. Performance comparison of four portable FTIR instruments for direct-on-filter measurement of respirable crystalline silica. *Ann Work Exp Health* 64(5):536–546.  
<https://doi.org/10.1093/annweh/wxaa031>
- Bartley DL, Chen CC, Song R, Fischbach TJ [1994]. Respirable aerosol sampler performance testing. *Am Ind Hyg Assoc J* 55(11):1036–1046.
- Cauda E, Chubb L, Miller A [2016]. Silica adds to respirable dust concerns. What if you could know the silica dust levels in a coal mine after every shift? *Coal Age* 121(1):31–33.
- CFR. Code of Federal Regulations. Washington, DC: U.S. Government Printing Office, Office of the Federal Register.
- Gallagher R [2021]. E-mail message from Bob Gallagher, Product Line Manager, Thermo Fisher Scientific to Jay Colinet, NIOSH, February 2.
- ISO [1995]. Air quality—particle size fraction definitions for health-related sampling. Geneva, Switzerland: International Organization for Standardization, ISO 7708:1995.
- Kissell FN, Sacks HK [2002]. Inaccuracy of area sampling for measuring the dust exposure of mining machine operators in coal mines. *Min Eng* 54(2):33–39.
- Miller AL, Drake PL, Murphy NC, Noll JD, Volkwein JC [2012]. Evaluating portable infrared spectrometers for measuring the silica content of coal dust. *J Env Mon* 14(1):48–55.
- MSHA [2018]. Infrared determination of quartz in respirable coal mine dust. U.S. Department of Labor, Mine Safety and Health Administration, Pittsburgh Safety and Health Technology Center, Method No. P-7.
- MSHA [2019a]. Equipment approval & certification, Approval and Certification Center, Mine Safety and Health Administration.  
<https://www.msha.gov/support-resources/equipment-approval-certification>
- MSHA [2019b]. CPDM status codes resulting in MSHA system voiding respirable dust samples.  
<https://www.msha.gov/sites/default/files/News%20Info/CPDM-status-code-voids-21April2016.pdf>
- NIH [2020]. U.S. Department of Health and Human Services, National Institutes of Health, NIH 3D print exchange. Components for the analysis of dust sampling cassettes with portable FTIR analyzers, Model ID 3DPX-013209. <https://3dprint.nih.gov/discover/3dpx-013209>
- NIOSH [1995]. Criteria for a recommended standard. Occupational exposure to respirable coal mine dust. Cincinnati, OH: U.S. Department of Health and Human Services, Centers for Disease Control and Prevention, National Institute for Occupational Safety and Health, DHHS (NIOSH) Publication No.95-106.

NIOSH [2003]. NIOSH manual of analytical methods (NMAM®), 4th ed., 3rd supplement. Schlecht PC, O'Connor PF, eds. Cincinnati, OH: U.S. Department of Health and Human Services, Centers for Disease Control and Prevention, National Institute for Occupational Safety and Health, DHHS (NIOSH) Publication No. 2003-154.

NIOSH [2006]. Laboratory and field performance of a continuously measuring personal respirable dust monitor. By Volkwein JC, Vinson RP, Page SJ, McWilliams LJ, Joy GJ, Mischler SE, Tuchman DP. Pittsburgh, PA: U.S. Department of Health and Human Services, Centers for Disease Control and Prevention, National Institute for Occupational Safety and Health, DHHS (NIOSH) Publication No. 2006-145, RI 9669.

NIOSH [2019a]. FAST-Field analysis of silica tool.  
<https://www.cdc.gov/niosh/mining/works/coversheet2056.html>

NIOSH [2019b]. Hardware and software requirements for field-based respirable crystalline silica monitoring. <https://www.cdc.gov/niosh/mining/content/HardwareandSoftwareforFAST.html>

NIOSH [forthcoming]. Direct-on-filter analysis for respirable crystalline silica using a portable FTIR instrument. By Chubb LG, Cauda EG. Pittsburgh, PA: U.S. Department of Health and Human Services, Centers for Disease Control and Prevention, National Institute for Occupational Safety and Health, DHHS (NIOSH).

Page SJ, Volkwein JC, Vinson RP, Joy GJ, Mischler SE, Tuchman DP, McWilliams LJ [2008]. Equivalency of a personal dust monitor to the current United States coal mine respirable dust sampler. *J Env Mon* 10(1):96-101.

Pampena JD, Cauda EG, Chubb LG, Meadows JJ [2019]. Use of the field-based silica monitoring technique in a coal mine: a case study. *Mining, Met Expl J*, DOI:<https://doi.org/10.1007/s42461-019-00161-0>

Parobeck PS, Tomb TF [2000]. MSHA's programs to quantify the crystalline silica content of respirable mine dust samples. SME preprint 00-159. Littleton, CO: Society for Mining, Metallurgy, and Exploration, Inc.

Sansone EB, Bell W, Buchino J [1973]. Penetration characteristics of the 10 mm nylon cyclone. Pittsburgh, PA: University of Pittsburgh, Department of the Interior, U.S. Bureau of Mines grant no. G 011 0124.

Thermo Scientific [2013]. Model pDR-1000AN/1200 instruction manual. Franklin, MA: Thermo Fisher Scientific, pp. 35-36.  
<https://assets.thermofisher.com/TFS-Assets/LSG/manuals/EPM-manual-PDR1000an.pdf>

Thermo Fisher Scientific [2019a]. PDM3700 personal dust monitor.  
<https://www.thermofisher.com/order/catalog/product/PDM3700#/PDM3700>

Thermo Fisher Scientific [2019b]. Operator's manual for PDM3700 personal dust monitor.  
<https://assets.thermofisher.com/TFS-Assets/LSG/manuals/EPM-manual-PDM3700.pdf>

USBM [1970]. Evaluation of the penetration characteristics of a horizontal plate elutriator and of a 10-mm nylon cyclone elutriator. By Tomb TF, Raymond LD. Pittsburgh, PA: U.S. Department of the Interior, Bureau of Mines, Report of Investigations 7367.



USBM [1973]. Comparison of respirable dust concentrations measured with MRE and modified personal gravimetric sampling equipment. By Tomb TF, Treaftis HN, Mundell RL, Parobeck PS. Pittsburgh, PA: U.S. Department of the Interior, Bureau of Mines, Report of Investigations 7772.

Zefon International [2019a]. Coal mine dust sampling system.

<https://www.zefon.com/Content/Products/SamplingMedia/Coal-Mine-Equipment.pdf>

Zefon International [2019b]. Cassette assembly, non-regulated.

<https://www.zefon.com/cassette-assembly-non-regulated>

Zefon International [2019c]. Zefon EoS (End of Shift) silica cassette.

<https://www.zefon.com/cassette-37mm-4pc-50%C2%B5m-pvc-pre-cf-ftir-10bx>

## CHAPTER 3: CONTROLLING RESPIRABLE DUST ON LONGWALL MINING SECTIONS

Longwall mining has the highest productivity of underground coal mining methods in the U.S. In 2018, longwall mines produced an average of 5.41 tons per employee hour, while continuous mining operations averaged 3.04 tons per employee hour [EIA 2019]. From 2006 through 2018, longwall mines accounted for an average of 54% of U.S. underground coal production, with an average of 174.4 million tons per year [EIA 2020]. In 2018, 12 longwalls produced over six million tons per face [Fiscor 2019]. Unfortunately, greater coal extraction can lead to higher levels of respirable dust generation, creating the need for more effective control technologies.

Historically, shearer operator and jacksetter occupations have the highest dust exposure of underground coal mining occupations. Mine Safety and Health Administration (MSHA) inspector sampling data from 2010 through 2019 was downloaded from MSHA's website [MSHA 2020a] and analyzed on a yearly basis for occupations located at the longwall and continuous miner production faces. Figure 3.1 shows the average respirable dust concentrations for each of these occupations and indicates that the tailgate shearer operator and jacksetter occupations continue to have higher respirable dust exposures than those found on continuous miner faces. In 2019, the average exposure for the two longwall occupations was over 0.3 milligrams per cubic meter of air ( $\text{mg}/\text{m}^3$ ) higher than the average of the three continuous miner occupations.

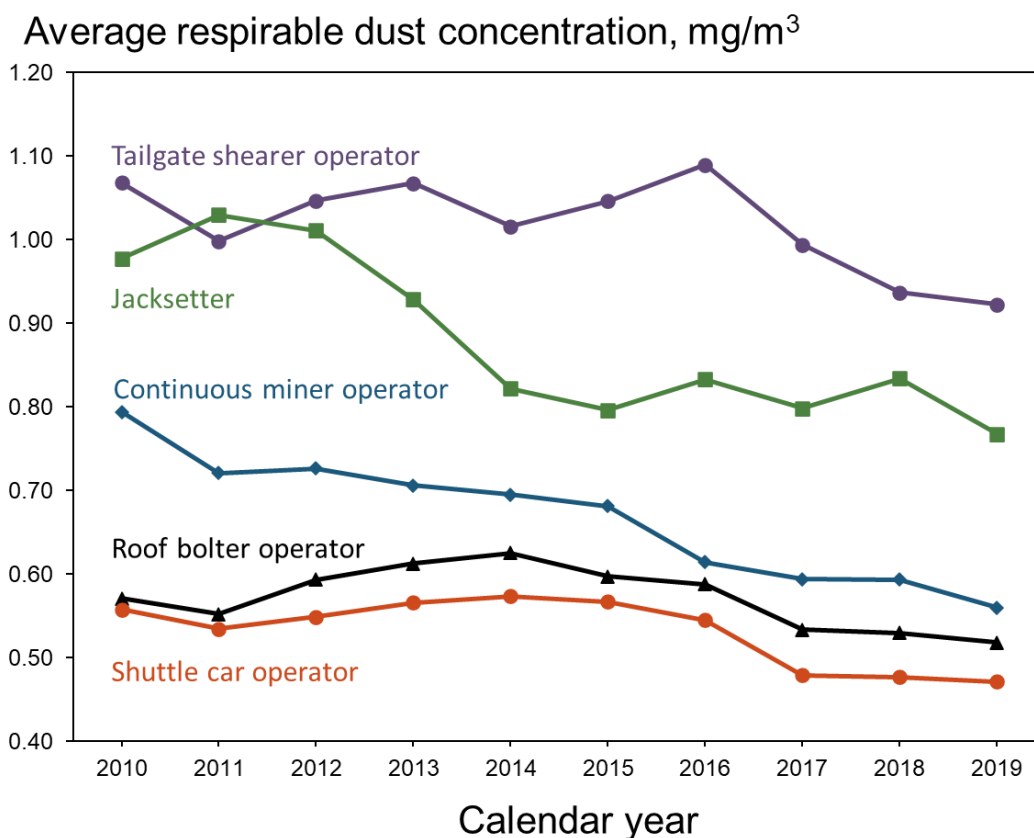
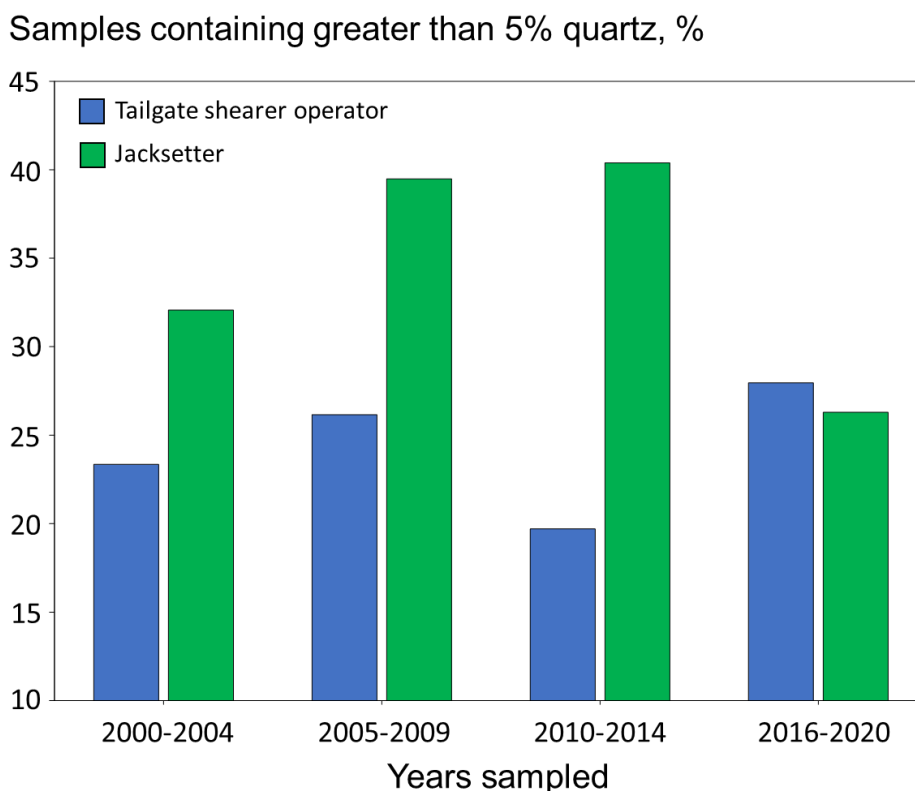

Figure 3.1. Average respirable dust concentrations calculated from samples collected by MSHA inspectors from 2010 through 2019.

The average dust levels in Figure 3.1 also show a general downward trend, particularly after 2016 for four of the five occupations. This data follows the industry-wide downward trend in dust levels that were previously reported by NIOSH [Doney et al. 2019]. In 2016, the respirable dust standard was lowered to 1.5 mg/m<sup>3</sup>, and underground mine operators were required to use a continuous personal dust monitor (CPDM) for compliance sampling as final changes included in the 2014 MSHA dust rule [79 Fed. Reg.<sup>13</sup> 24814 (2014)]. It appears that the changes to the respirable dust sampling regulations and mine operators' responses to these changes are reducing the exposure of underground coal mine workers.

Quartz dust sampling results for 2000 through 2020 for the tailgate shearer and jacksetter occupations were downloaded from the MSHA website [MSHA 2020b] and analyzed. Data was omitted for the transition period in sampling regulations beginning on August 1, 2014, when the initial parts of the 2014 MSHA dust rule were implemented until the last change on August 1, 2016, when the reduced dust standard was implemented. Figure 3.2 summarizes these sampling results and shows the percentage of samples that contained greater than 5% quartz, which was the historic criteria for enforcing a reduced dust standard. The jacksetter had a higher percentage of samples exceeding 5% quartz than the tailgate shearer operator until after the 2014 dust rule was fully enacted, when they are nearly equal. Although a substantial percentage of these samples exceeded 5% quartz, data presented in Chapter 4 shows that even higher percentages of samples for continuous miner and roof bolter operators contained more than 5% quartz.



**Figure 3.2. Percentage of MSHA inspector samples analyzed for quartz for the tailgate shearer operator and jacksetter that exceeded 5% quartz.**

<sup>13</sup> Federal Register. See Fed. Reg. in references.

Longwall workers can be exposed to harmful respirable dust from multiple dust generation sources, including the intake entry, belt entry, stageloader-crusher, shearer, and shield advance. This chapter discusses dust control technologies that are available to reduce dust liberated from each of these sources. Emerging controls that have the potential to provide additional dust reductions but currently not in use will also be discussed at the end of the chapter.

## Primary Dust Controls

All underground mining operations utilize ventilating air and water sprays as primary methods for controlling respirable dust generation and worker exposures. Each of these control methods reduces mine workers' dust exposure through several different means. Proper application of each of these controls will optimize the opportunity for controlling respirable dust.

### Ventilation

Ventilating air is supplied throughout underground mines to dilute airborne contaminants such as dust, methane, and diesel exhaust to safe levels and to move these contaminants away from mine workers. The quantity and velocity of air supplied may be the most critical component of controlling mine worker exposure to these airborne contaminants. Therefore, underground coal mine regulations [30 CFR 75.325<sup>14</sup>] require minimum quantities of air at specific locations for each type of mining. Also, mine operators are required to develop a ventilation plan for each working section or mechanized mining unit (MMU) and to submit this plan for approval to the MSHA district manager before mining can begin production on that MMU. This plan will specify the minimum quantity of air that will be supplied to the MMU, and this minimum quantity must be maintained at all times. Typically, the minimum quantities specified in these plans will exceed the minimums specified in the CFR.

For a given volume of dust generated by any source, increasing the quantity of ventilating air will lead to greater dilution of the dust and lower the concentration to which workers are potentially exposed. In addition, the velocity of the ventilating air dictates the speed at which dust is moved away from workers and into the return. Higher velocities will minimize the time that dust remains in the vicinity of workers. Consequently, air quantity and air velocity are both important factors in controlling the respirable dust exposure of mine workers.

For longwall faces in the U.S., intake air is directed from the headgate-to-tailgate. This allows workers in the headgate entry and the headgate shearer operator to be upwind of the dust being generated by the shearer, which has historically been the largest source of dust generation on longwalls [Colinet et al. 1997; Rider and Colinet 2011].

### Water Sprays

Water sprays can help control the dust exposure of mine workers through three different methods: suppression, airborne dust capture, and redirection.

- For *suppression*, water is applied at the point of dust generation (e.g., cutting bits, conveyor transfer points, crushers) to wet the coal so respirable particles adhere to one

---

<sup>14</sup> Code of Federal Regulations. See CFR in references.

another or larger particles. The goal is to keep the respirable dust that was generated from getting entrained by the ventilating air.

- For *airborne dust capture*, water spray droplets attempt to impact and agglomerate with dust particles in order to increase the mass of the particles so that they settle out of the airstream. As shown in Figure 3.3, water droplets that are closer in size to the dust particle are more likely to impact the dust particle, as opposed to the particle following the airstreams around the droplet.
- For *redirection*, all water sprays induce airflow movement to some degree with their spray pattern. If properly located, sprays can then be used to help direct airborne dust away from the breathing zone of mine workers.

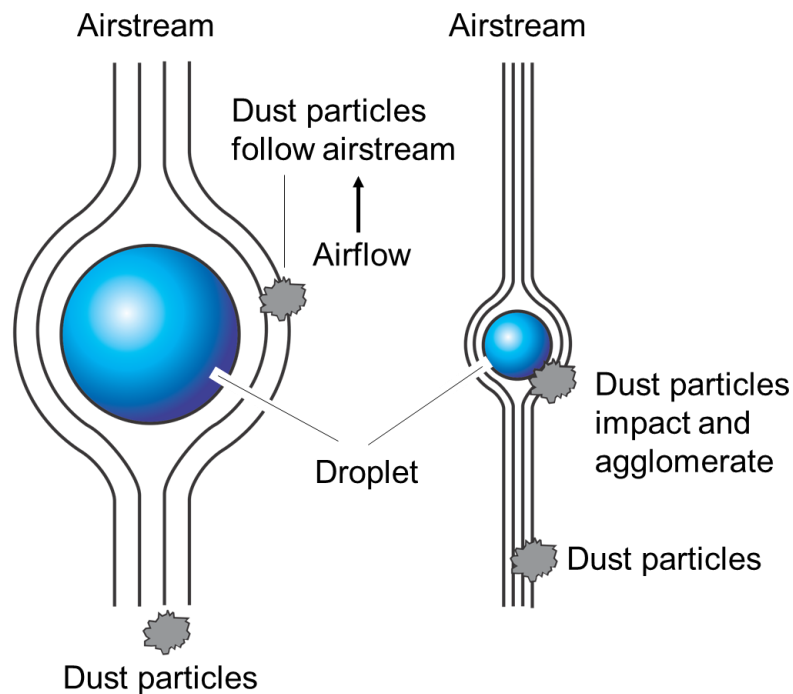

**Figure 3.3. Effect of water droplet size on particle impingement (adapted from Schowengerdt and Brown [1976]).**

The type of nozzle, operating parameters, and nozzle location and orientation are critical components in determining the relative success of each spray application, depending on the method of dust control desired. A general description of nozzle types typically available for use in mining are provided here, with specific information related to spray implementation for different dust sources provided throughout this handbook.

### *Hollow Cone Spray*

Hollow cone spray nozzles (Figure 3.4, left) produce a circular, outer-ring spray pattern as shown in Figure 3.4, right. When compared at the same flow rate to the other nozzles discussed below, hollow cone sprays typically produce droplets that are smaller in size. Past research has shown that smaller and faster moving droplets increase the capture of airborne respirable dust [Pollock and Organiscak 2007]. In addition, hollow cone nozzles induce more airflow movement

than most of the other nozzles discussed. Because of their larger orifices, these nozzles are less likely to clog [NIOSH 2003]. Consequently, hollow cone sprays are a popular choice among mine operators and are used in multiple mining applications, particularly where dust knockdown and directing dust away from the worker are desired.



Photos by Spraying Systems Co.

**Figure 3.4. Hollow cone spray nozzle (left) and spray pattern (right).**

### *Full Cone Spray*

Full cone spray nozzles (Figure 3.5, left) produce a solid, cone-shaped spray pattern, typically with a round impact area as shown in Figure 3.5, right. These sprays produce medium to large droplet sizes that can travel over longer distances than hollow cone spray droplets [Spraying Systems 2016]. They are normally used when the sprays need to be located farther away from the dust source or when a uniform wetting pattern is desired. Full cone sprays are available in a wide range of operating pressures and flows and are useful for wetting material for suppression.



Photo by Lecher

Photo by Spraying Systems Co.

**Figure 3.5. Full cone spray nozzle (left) and spray pattern (right).**

### *Flat Fan Spray*

Flat fan sprays (Figure 3.6, left) produce a thin, rectangular spray pattern as shown in Figure 3.6, right. These sprays produce medium-sized droplets with an even distribution across the pattern. Flat fan sprays offer a wide range of flows and spray angles and can be used as a means of dust containment.

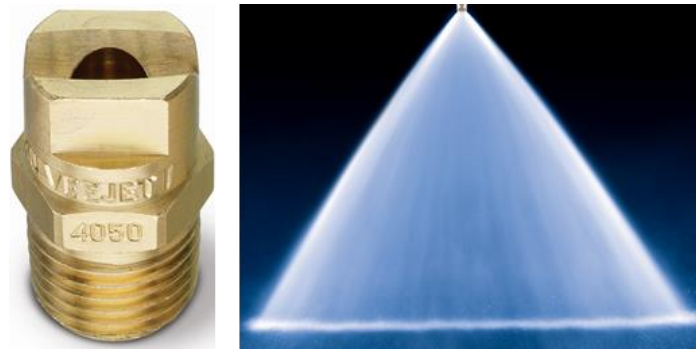

Photos by Spraying Systems Co.

**Figure 3.6. Flat fan nozzle (left) and spray pattern (right).**

### *Solid Stream Spray*

Solid stream nozzles (Figure 3.7, left) produce a compact, solid stream of water as shown in Figure 3.7, right. These nozzles produce nearly turbulent-free flow with the greatest impact per unit area, when all operating parameters are equivalent [Lechler 2020]. As such, the water stream can penetrate unconsolidated material to provide wetting for dust suppression. The force provided by these nozzles can also be used to clean material from the tops of continuous miners and shearers.



Photo by Lecher

Photo by Spraying Systems Co.

**Figure 3.7. Solid stream nozzle (left) and spray pattern (right).**

### *Venturi Spray*

Venturi sprays have a nozzle mounted inside of a tapered tube as shown in Figure 3.8. This tube focuses the water droplets into a dense hollow cone spray pattern, while inducing airflow through the tube [Conflow 2020]. These nozzles remove dust from the induced air and also move air in the direction of spray orientation. Consequently, these sprays are implemented for their air moving capability and dust capture.

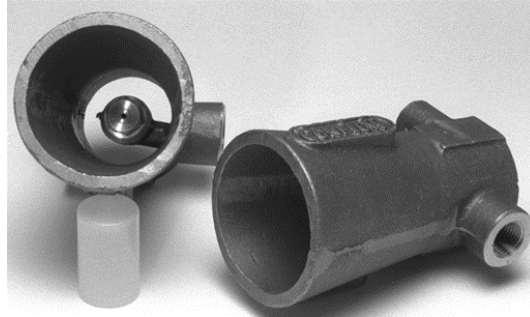
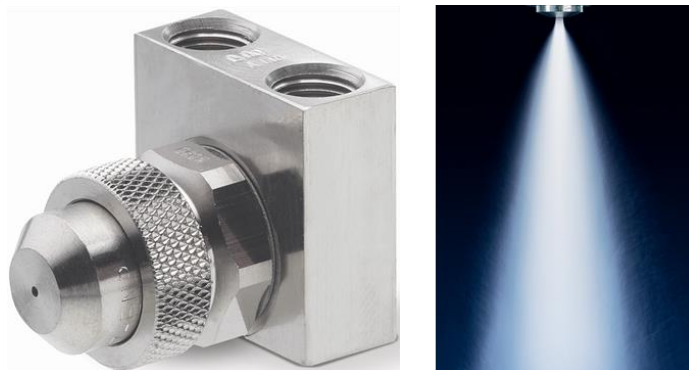

Photo by Conflow

**Figure 3.8. Venturi spray with nozzle mounted in center.**

### *Air Atomizing Spray*

Air atomizing nozzles (Figure 3.9, left) use compressed air to atomize the water and produce very fine droplets—smaller and with higher velocity than those produced by most of the other nozzles discussed. These nozzles can be used to produce cone or flat spray patterns as shown in Figure 3.9, right, typically at low water flow rates.



Photos by Spraying Systems Co.

**Figure 3.9. Air atomizing nozzle (left) and flat spray pattern (right).  
Nozzle has inlets for required air and water supply lines.**

The airborne respirable dust capture performance of four different spray nozzles was evaluated over a range of operating pressures. Figure 3.10 illustrates the relative effectiveness of each spray type for a given unit of water [USBM 1982]. As shown, the air atomizing nozzle exhibited the best airborne dust capture. Unfortunately, these nozzles have small orifices and are more prone to clogging, particularly in underground applications. Also, these nozzles require compressed air supply lines to each nozzle, complicating their use underground. Consequently, mining operations typically select hollow cone spray nozzles for airborne dust capture applications rather than air atomizing nozzles.

Regardless of the nozzle tested, Figure 3.10 also shows that an increase in water pressure improves airborne dust capture. This results from the higher pressure creating smaller droplets with increased velocity.



Equivalent volume of air cleaned 100% free of dust by a unit volume of water

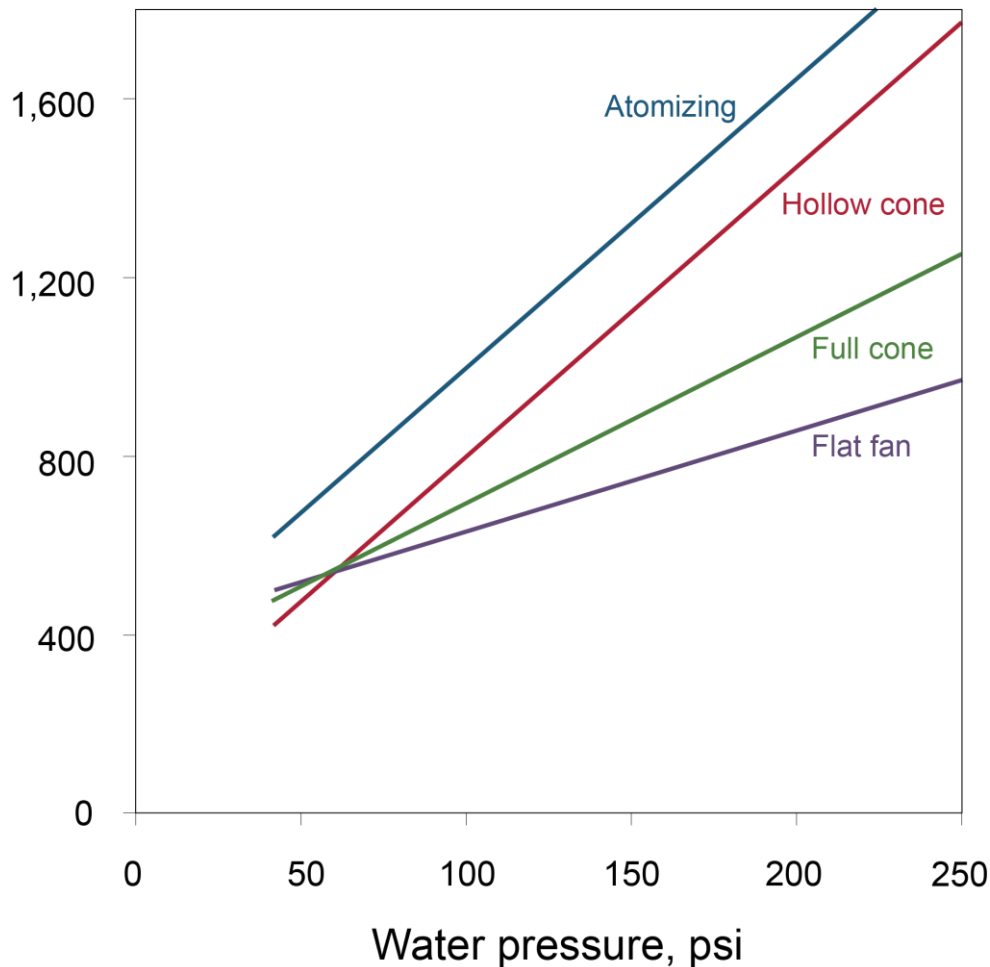

Figure 3.10. Performance of four spray types for capturing airborne respirable dust.

### Controlling Respirable Dust Liberation from Intake Roadways

If not adequately controlled, respirable dust concentrations from intake roadways can have a significant effect on dust exposures of longwall face workers. Past longwall dust surveys revealed that respirable dust levels in the last open crosscut can be as high as  $0.42 \text{ mg/m}^3$  [Rider and Colinet 2011]. In the 2014 dust rule passed by MSHA, the standard for intake dust levels was lowered to  $0.5 \text{ mg/m}^3$  from the previous standard of  $1.0 \text{ mg/m}^3$ , so diligent control of intake dust levels is necessary.

As longwall production has increased, mine operators are supplying larger quantities of air to the face to control methane and dust liberation. Higher air velocities in the intake entries may result in increased dust entrainment if proper controls are not applied and maintained. Increasing air velocities have been shown to have the potential to entrain greater quantities of dust, particularly when the dust is disturbed by personnel or equipment movement and sufficient moisture is not present [Shankar and Ramani 1995].

The practices described below can help control respirable dust levels along intake roadways.

## Limiting Outby Support Activities During Production Shifts

Normal outby activities that disturb dry dust on the intake roadways, such as vehicle movement, unloading supplies, removing belt structure, and removal of stoppings, can liberate respirable dust into the intake air. This dust can be carried with the intake air to the longwall face and can expose workers. If these support activities can be shifted to times when the longwall face is not producing, this potential source of dust exposure from the intake will be “eliminated” for production workers at the headgate and on the face. As noted in the hierarchy of controls discussed in the Introduction, elimination is the preferred method for controlling occupational hazards. This is an example where the source of dust exposure can be eliminated for face production workers by shifting work practices.

## Water Application

If the mine floor is composed of unconsolidated dry material, adding moisture is crucial for reducing respirable dust entrainment into the intake air. Operators should be aware of the moisture content of the intake roadway material, particularly with the large air quantities traveling toward longwall faces and during dry winter months. Information on studies to determine the amount of moisture required to control dust liberation from underground roadways was not found in the literature search. However, some guidance for controlling dust liberation from unpaved haul roads at a coal-fired power plant was available and indicated that increasing moisture content from 2% or less to approximately 4% resulted in a dust reduction of 75% [Cowherd, Jr. 1990; Cowherd et al. 1988]. Increasing the moisture content above this level resulted in much smaller increases in control efficiency.

## Hydroscopic Compounds and Surfactants

Hydroscopic compounds such as calcium chloride, magnesium chloride, hydrated lime, and sodium silicates increase roadway surface moisture by extracting moisture from the air. Applications of these materials will help maintain the moisture content of the road surface [Midwest Research Institute 1981]. Surfactants such as soaps and detergents dissolve in water and can be beneficial in maintaining the proper moisture content of the intake roadways. Surfactants decrease the surface tension of water, which allows the available moisture to wet more particles per unit volume [Midwest Research Institute 1981]. A wide variety of these chemicals are available and a key for achieving the greatest benefit is through proper application as recommended by the individual product suppliers.

## Controlling Respirable Dust from the Belt Entry

Using the belt entry to supply intake air will allow the delivery of more air to the face, providing the potential for better dust and methane dilution. Information from MSHA indicates that 12 longwall operations were using belt entry air in 2020 [Meikle 2020]. The use of belt air to ventilate a working face must be approved by the MSHA district manager, and no more than 50% of the total intake air delivered to the working face can be supplied from the belt air course [30 CFR 75.350]. When used to supply intake air, the average respirable dust concentration in the belt air must be maintained at or below  $0.5 \text{ mg/m}^3$  as of August 1, 2016. Studies conducted by the U.S. Bureau of Mines indicated that any potential addition to dust levels at the longwall face from the belt entry seemed to be mitigated by dilution from the additional air brought up the belt entry [USBM 1992; Jankowski and Colinet 2000].

Given the increases in the quantity of coal being transported outby the longwall face, operators must diligently and properly implement and maintain the belt entry dust suppression controls to keep fugitive dust from being carried to the face area. The following practices can help control respirable dust levels in the belt entry.

### Maintaining the Belt

Properly loading the belt and maintaining the belt alignment, rollers, and idlers are key operating practices necessary to minimize respirable dust generation in the belt entry. Uneven loading, missing rollers, belt slippage, and worn belts can cause belt misalignment and create spillage leading to dust entrainment in the ventilating air [USBM 1986].

### Wetting the Coal on the Belt

If the mined coal is wetted adequately at the face and in the crusher and stageloader, less dust will be liberated during transport along the belt entry and subsequent transfer points. Past research indicated that a moisture content of up to 4% by weight was a useful maximum for the amount of water application needed [Stahura 1997]. When considering the length of longwall panels and belt transfer distances out of current mines, rewetting of the coal may be necessary at multiple intervals along the belt. Flat fan sprays and full cone nozzles are typically used for coal wetting along the belt. Water should be applied at operating pressures of about 50 pounds per square inch (psi) [Kost et al. 1981].

Recently, NIOSH researchers added a wetting agent to water sprays at a belt transfer to evaluate impact on respirable and float dust levels [Beck et al. 2020]. Results show that the wetting agent reduced respirable dust by 46% compared to 28% with plain water. More information on this research is presented in Chapter 6.

### Belt Cleaning with Scrapers and Brushes

When mined material on the belt is properly wetted to reduce dust liberation during transport, a portion of this material may cling to the belt on its return toward the tail pulley. This material is commonly referred to as carryback. As the material dries and the belt passes over the return rollers, respirable dust can be released into the air and larger material deposited on the mine floor [NIOSH 2003; USBM 1986]. This deposited dust accumulates and must eventually be cleaned up, which can be a safety and dust issue.

Removing the carryback from the belt at the head pulley discharge should be a goal for minimizing the amount of dust generated by the belt. Often a primary scraper and a secondary scraper are used to remove carryback material from the belt. Figure 3.11, left, illustrates preferred locations for the primary and secondary scrapers. Primary scrapers are often positioned on the lower portion of the head pulley just below the material discharge point, with the secondary scraper ideally positioned close to the head pulley. Figure 3.11, right, is a photo of a primary scraper installed on a mine conveyor belt.

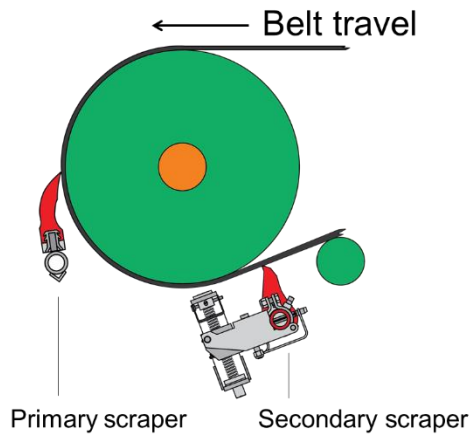

Photo by Flexco

**Figure 3.11. Typical locations of primary and secondary belt scrapers (left) and a photo of a primary belt scraper installed (right).**

To protect the belt, the primary scraper should be incorporated with low blade-to-belt pressure (approximately 2 pound force per square inch [ $\text{lb}_f/\text{in}^2$ ]), while the secondary scraper should have 11–14  $\text{lb}_f/\text{in}^2$  of pressure [Swinderman et al. 2013; USBM 1989a]. All scrapers should have the ability to move away from the belt when a splice or damaged section of belt passes the scrapers. Also, with belt cleaning occurring near the head pulley, chutes can be installed to direct the cleaned material back into the primary material flow.

Figure 3.12, left and center, shows secondary scrapers installed on belts. An alternative to the secondary scraper is a motor-driven rotary brush [USBM 1986] that cleans the conveying side of the belt during return, as shown in Figure 3.12, right. This brush rotates in the opposite direction of belt travel and should be located close to the dump point so that the material removed from the belt is still wet and agglomerated as it is brushed off. If wet material begins to build up on the brush, a beater bar or comb can be installed to help clear the material buildup.

Low-quantity water sprays may be implemented to moisten the belt and carryback material to assist with the belt cleaning. Typically, the water sprays are located between the primary and secondary scrapers [Arnott 2019]. Previous studies have shown that water sprays in conjunction with belt scrapers significantly reduced airborne respirable dust levels [Stahura 1987; Baig et al. 1994].



Photo by Metso



Photo by Richwood



Photo by Kinder

**Figure 3.12. Secondary belt scrapers (left and center) and a rotating brush (right).**

## Wetting Dry Belts

As the belt returns from the dump point to the tailpiece, dried material can also be dislodged from the nonconveying side (bottom) of the belt and liberate dust into the ventilating air. Studies show that wetting the bottom of the belt with a full cone water spray followed by a piece of material such as a piece of felt indoor-outdoor carpet can significantly reduce dust levels. Figure 3.13, left, shows how the carpet is positioned across the belt to remove the wetted dust fines. Dust reductions approaching 90% were observed in two studies [Allen 1983; Courtney 1983].

Belt plows are another option for cleaning the nonconveying side of the belt. These plows contain blades that scrape material from the belt. They can be v-shaped models that disperse material to each side of the belt as shown in Figure 3.13, right, or straight sections mounted diagonally on the belt to disperse material off one side of the belt.

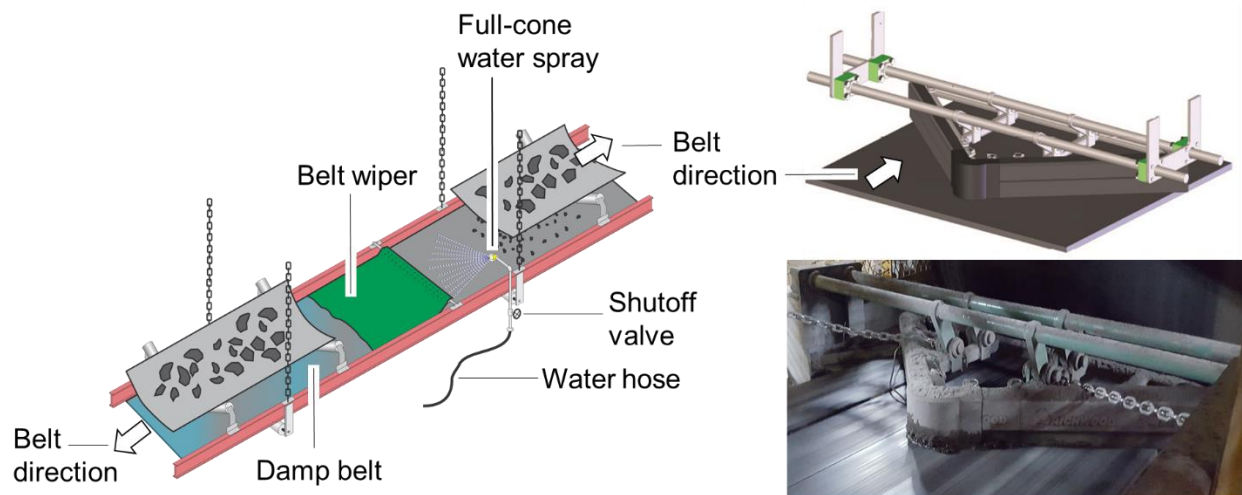

Left illustration by NIOSH

Top right illustration and bottom right photo by Richwood

**Figure 3.13. Water sprays and belt wiper (left), and schematic (top right) and photo of v-shaped belt plow (bottom right) used to remove material from the nonconveying side of the belt.**

## Controlling Respirable Dust at the Stageloader-Crusher and in the Headgate Area

Respirable dust generated by outby sources can enter the ventilating airstream and remain airborne across the entire longwall face, which can impact the dust exposure of all personnel on the face. The stageloader-crusher is the most significant dust-generating source in the headgate area. The breaking of coal and rock in the crusher generates large quantities of dust, which can mix with the ventilating airstream. The following practices can help control respirable dust levels in the stageloader-crusher area.

## Fully Enclosing the Stageloader-Crusher

Previous U.S. Bureau of Mines (USBM) research indicated that stageloader-crusher units should be fully enclosed to reduce dust liberation into the ventilating air [USBM 1985]. More recent NIOSH surveys at 10 longwalls found that all stageloader-crushers were fully enclosed by mine operators [Rider and Colinet 2011]. However, there was no universally applied technique for enclosing the stageloader-crusher. The common practice is to apply a combination of steel plates, strips of conveyor belting, brattice, and/or foam to seal the crusher and stageloader units along their entire length. In addition, conveyor belting covering both the entrance to the crusher and the stageloader-to-belt transfer has been effective in keeping dust from boiling out of the enclosure and into the ventilating airstream. Strips of belting can be hung from the top of the crusher inlet (Figure 3.14) and stageloader outlet (Figure 3.16, right), effectively enclosing these areas. Stageloader-crusher units that are more enclosed than earlier units are now available from manufacturers (Figure 3.14, right). Considering the quantity of coal being transported through the stageloader-crusher, it is imperative that all seals and skirts be carefully maintained to confine dust generated within the enclosure.

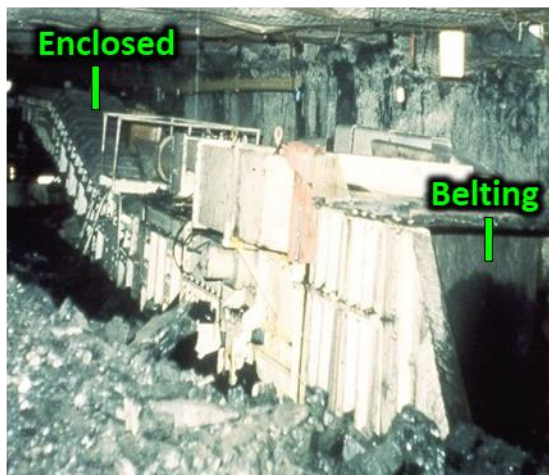

Photo by NIOSH

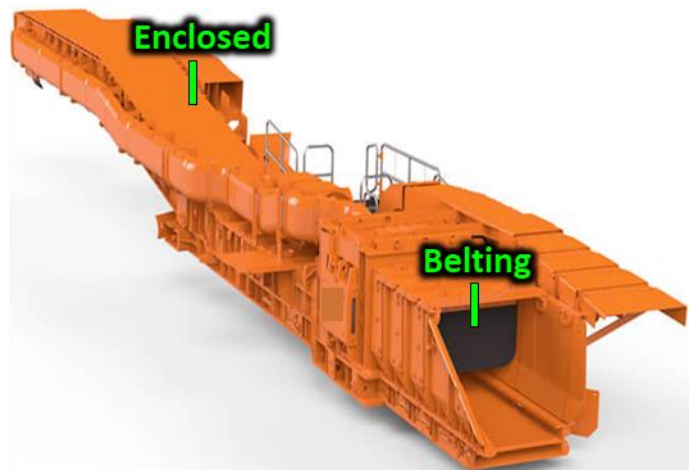
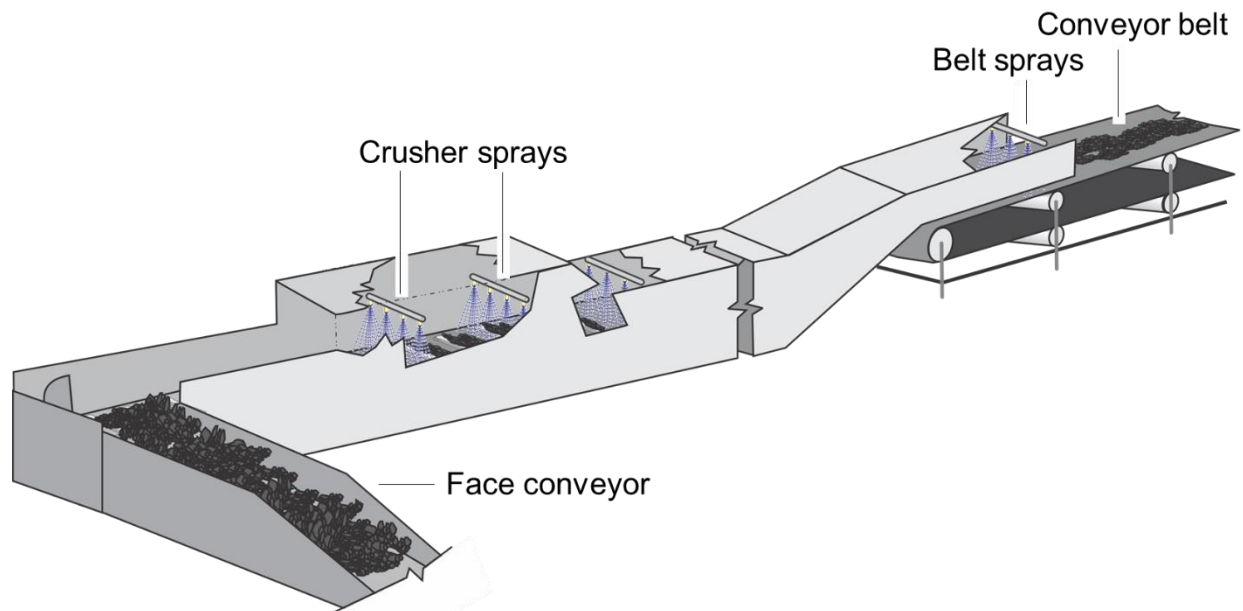

Photo by Joy Global Underground Mining

**Figure 3.14. Stageloader-crusher enclosed by mine operator (left) and a new unit offered by a manufacturer (right).**

## Wetting Coal in the Stageloader-Crusher

Stageloader-crushers should have a series of spray manifolds located throughout the unit to wet the coal product to prevent respirable dust from becoming airborne. These spray manifolds should contain enough nozzles to ensure uniform spray coverage across the width of the coal stream. Spray manifolds consisting of three or four full cone sprays are typically sufficient to provide this coverage. At a minimum, manifolds should be mounted at the entrance to the crusher, at the crusher discharge, and at the stageloader-to-belt discharge as shown in Figure 3.15. Initial research indicated that fully enclosing the crusher and supplying a total of 20 gallons per minute (gpm) to the sprays shown in Figure 3.15 reduced respirable dust levels at the stageloader by 74% and by 41% at shield 20 [USBM 1986].

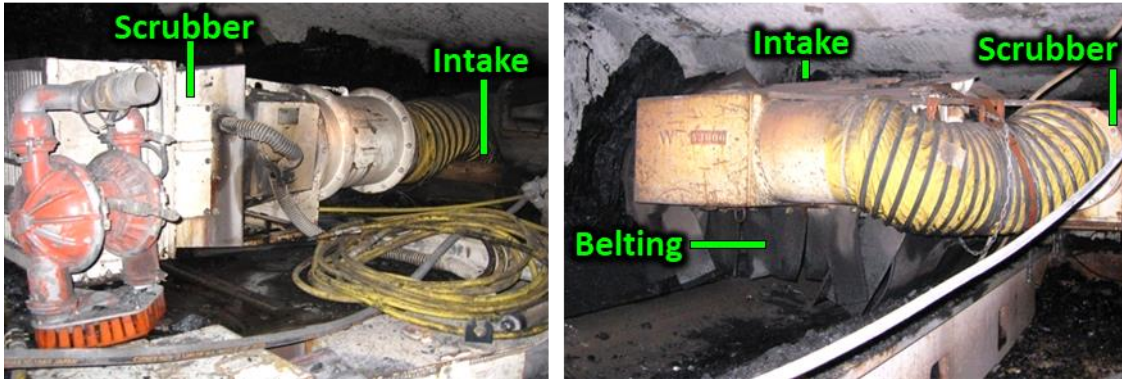

**Figure 3.15. Illustration showing how coal flows from the face conveyor into the enclosed crusher and stageloader where water sprays wet the coal during transport.**

Previous studies have shown that low water pressure and high-volume sprays are the most effective at containing dust within the enclosure [USBM 1985; Kelly and Ruggieri 1990]. High water spray pressure should be avoided since elevated pressure within the enclosure can force dust out into the ventilating airstream. Because water quantity is more critical than water pressure, full cone sprays operating at water pressures below 60 psi is recommended. If increased wetting is needed, additional manifolds can be installed or larger orifice nozzles can be utilized in the existing manifolds.

### Using a Fan-powered Scrubber at the Stageloader

To keep fugitive dust from escaping the stageloader-crusher area, fan-powered scrubbers can be used if the mining entry has sufficient height to accommodate mounting on top of the stageloader. When scrubbers are used, their intakes are commonly ducted from the crusher discharge area (Figure 3.16, left) and the stageloader-to-belt transfer (Figure 3.16, right). When possible, the scrubber should discharge into the return air. Flow rates through each scrubber observed by NIOSH typically ranged from 6,500 to 8,500 cubic feet per minute (cfm). Scrubbers with an airflow capacity of more than 17,000 cfm are now available [Defibaugh 2021]. In addition to capturing airborne dust, scrubbers also create a negative pressure within the enclosed stageloader-crusher to minimize dust leakage if gaps are present.



Photos by NIOSH

**Figure 3.16. Fan-powered scrubbers with intakes at the crusher discharge (left) and stagel loader-to-belt transfer (right). Belting is hung from the transfer to further confine dust.**

### Using a Water-powered Scrubber at the Stagel loader

A compact, high-pressure, water-powered scrubber is an alternative to fan-powered scrubbers [Kelly and Ruggieri 1990]. A water spray installed at the center of a tube and operated at pressures of at least 1,000 psi will induce airflow through the tube and capture most of the dust in the airflow [USBM 1981]. Since this scrubber is water-powered, it is intrinsically safe in relation to methane. Maintenance requirements are minimal because the scrubber has no moving parts. Successful underground tests were conducted where contaminated air was drawn through a series of five tubes with sprays attached to each tube. The dirty air was scrubbed through the tubes and demisted through a wave-blade demister. Figure 3.17 shows the scrubber mounted on top of the crusher. Cleaned air was discharged toward the face. Field tests showed that the scrubber reduced dust concentrations by more than 50% when operated at 1,200 psi and 10 gpm.

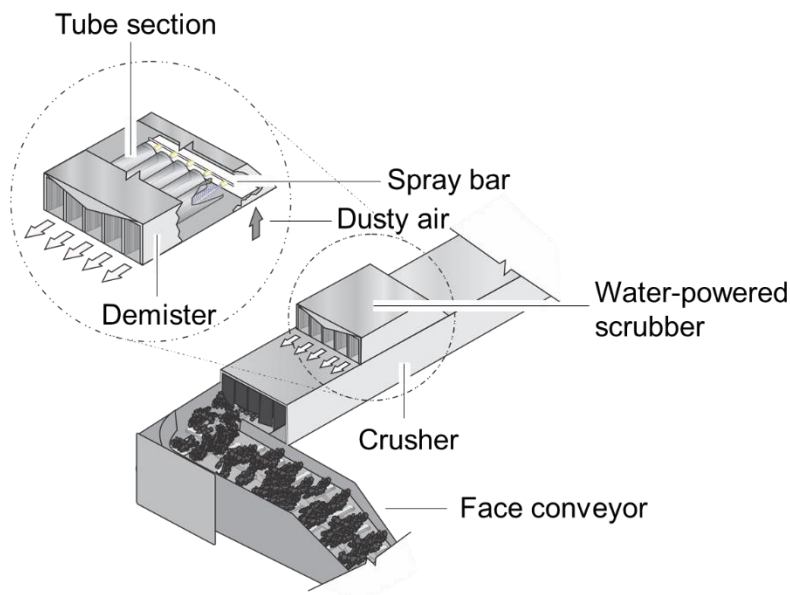

**Figure 3.17. High-pressure water-powered scrubber installed on top of crusher.**



Another water-powered scrubber was also tested at the stageloader with the inlet located close to the crusher discharge [Grigal et al. 1982]. This system used approximately 9 gpm of water at 500 psi to create an airflow of 2,000 cfm. When tested, this scrubber reduced intake dust levels on the longwall face by 50%.

In addition to the stageloader-crusher controls, the following practices at the headgate can help reduce the dust exposure of longwall face workers.

### Installing a Gob Curtain

A concerted effort should be made to ensure that the air coming through the intake and belt entries reaches and ventilates the longwall face at the required quantity. Air can flow into the collapsed area behind the shields, which is known as the gob. As a result of roof bolting in the belt entry during panel development, the roof behind the shield supports in the belt entry may not collapse as quickly as it does along the rest of the face. This can result in an open area behind the first few shields and allow a substantial portion of the ventilating air delivered to the headgate to leak into the gob. Also, the open area between the first shield and the rib facilitates air passage directly into the gob as shown in Figure 3.18, top left. Even if the fresh air traveling into the gob reenters the face, it may become contaminated with dust and methane.

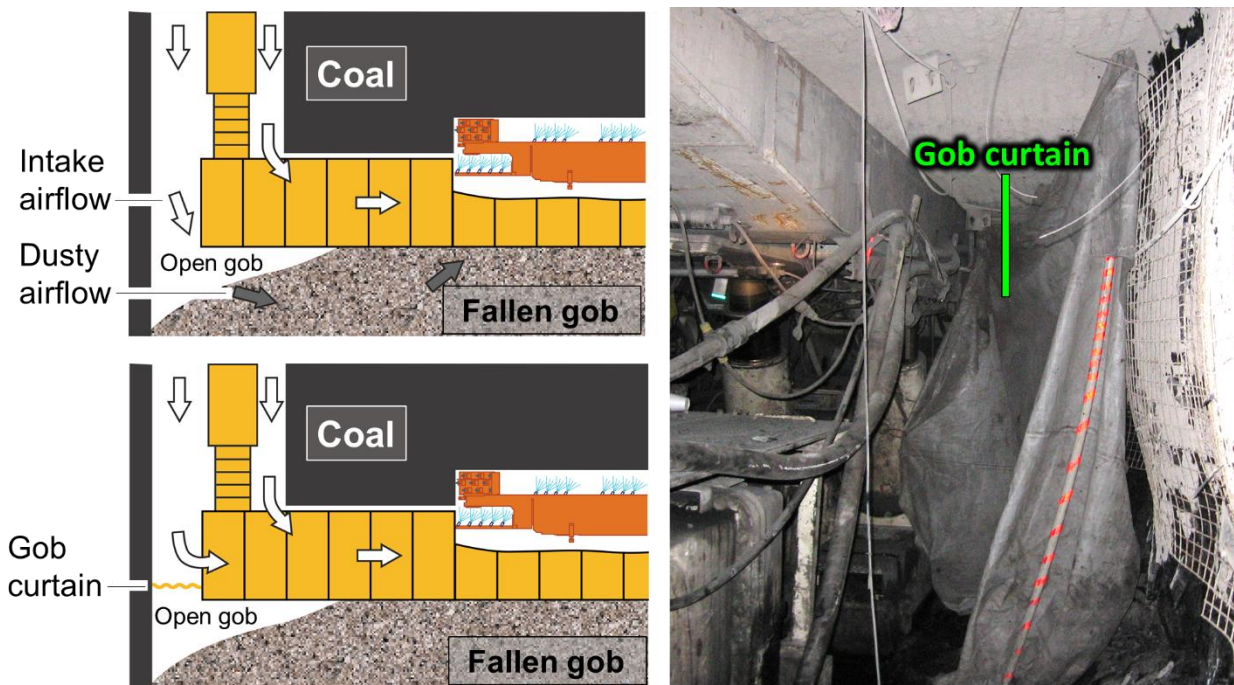

Photo by NIOSH

**Figure 3.18. Airflow leaking through shields into gob (top left), and installation of a gob curtain to increase airflow down the face (bottom left and right photo).**

As illustrated in Figure 3.18, bottom left, a “gob curtain” should be installed between the first shield and the rib in the headgate entry as shown in the photo in Figure 3.18, right. This curtain forces the ventilating air to make a 90-degree turn down the longwall face rather than leak into the gob. Several longwall operations have further reduced air leakage into the gob by installing brattice curtain behind the hydraulic support legs in the back of the first several shields.

Studies show the average face air velocity with the curtain installed was about 35% greater than without the curtain [Jankowski and Colinet 2000]. The most significant improvement observed was in the first 25–30 shields, where increased air volume lowered dust concentrations through dilution. NIOSH longwall surveys have found that gob curtains were routinely being used in the headgate entry [Rider and Colinet 2011]. Unfortunately, not all of these curtains were being properly maintained, resulting in gaps that allowed air leakage into the gob.

### Repositioning Shearer Operators During Cutout

One source of elevated dust concentrations for shearer operators is the headgate drum when it completes a cut into the headgate entry. The drum is exposed to the primary airstream, resulting in high-velocity air passing over the cutting drum. This air picks up large quantities of respirable dust as it moves onto the longwall face with the potential to expose the shearer operators as shown in Figure 3.19, left. Although the cutout time is relatively short, the dust levels on the face where the shearer operators are typically located can be high and have been observed in the range of 20–30 mg/m<sup>3</sup> [Jankowski and Colinet 2000].

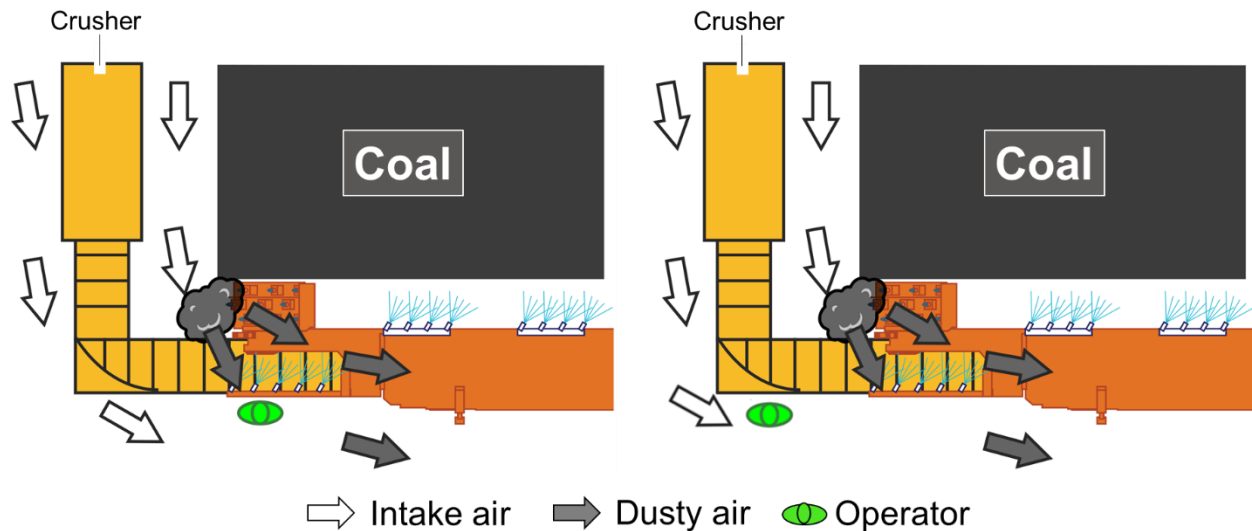

**Figure 3.19. Shearer operator's dust exposure when positioned at the headgate drum (left) and repositioned upwind (right) during the cutout at the headgate.**

During recent NIOSH dust surveys, researchers noted that a concerted effort was made by both the headgate and tailgate shearer operators at many longwalls to move outby the shearer headgate drum prior to the drum cutting out into the entry. Typically, they positioned themselves at shields 1 or 2 behind the face conveyor drive motor, which is upwind of the headgate drum cutout as shown in Figure 3.19, right. This location can reduce the shearer operators' dust exposure and offers protection from flying coal.

### Controlling Shearer-generated Dust

Previous longwall studies have shown that the shearer was the largest source of dust on longwall panels when compared with intake, stageloader, and shield support dust sources [Colinet et al. 1997; Rider and Colinet 2011]. The shearer accounted for approximately 50% of all dust generated during mining. Therefore, shearer-generated dust should be a major focus of

any control effort, especially when a bidirectional cutting sequence is used. A discussion of several technologies for controlling shearer-generated dust follows.

## Face Ventilation

Federal mining regulations [30 CFR 75.325] require a minimum air quantity of 30,000 cfm be provided at the headgate of longwall faces. Considering the high production capacity of contemporary longwalls, the actual quantity of air provided is much greater. Data from 2011 provided by MSHA shows that the average air quantity from 30 longwall faces was greater than 67,000 cfm, with seven of the 30 faces supplying over 90,000 cfm [Lindahl 2015]. This average air quantity represents an increase of approximately 65% when compared to the average quantity found in mid-1990s longwall surveys conducted by NIOSH [Colinet et al. 1997]. The maximum air quantity on any longwall in the MSHA data was over 146,000 cfm. Therefore, as production levels from longwalls have increased, ventilation supplied to the longwalls has also increased substantially to help control respirable dust levels.

In addition to the minimum air quantity required, MSHA generally requires minimum face air velocities, which are typically measured at shield 10 and 10 shields from the tailgate. The average air velocity in 2011 for the 30 longwall faces mentioned above was nearly 750 feet per minute (fpm), with eight of the 30 faces having velocities above 900 fpm. The maximum air velocity was over 1,300 fpm. Higher air velocities at the shearer help confine generated dust closer to the face and move it more quickly beyond the shearer operators before it spreads into the walkway [Jankowski and Kissell 1983]. However, it is important to ensure that sufficient wetting of the coal is provided to minimize the potential of increased entrainment at these higher air velocities. A German study reported that the optimum velocity range may be increased to 700–900 fpm when the moisture content of the dust particles is 5%–8% [Breuer 1972]. An MSHA study reported that as face air quantities increased, even beyond 1,200 fpm, respirable dust levels along the face decreased [Tomb et al. 1992].

## Drum-mounted Water Sprays

Drum-mounted spray nozzles apply water for dust suppression directly at the point of coal fracture and add moisture to the product to minimize dust liberation during coal transport. Research has shown that dust levels at the shearer were reduced 40% or more by increasing the quantity of water supplied to the cutting drums [Jankowski et al. 1986]. Full cone sprays are the most effective type of spray pattern to use in shearer drums. These sprays can supply the needed quantity of water for wetting without inducing substantial air movement around the drum.

Although very important for minimizing dust generation at the point of coal fracture, shearer drum water sprays also have the potential to increase airborne respirable dust levels when operated at water pressures that are too high. This is particularly true for the trailing drum which typically is not fully immersed in coal. At elevated pressures, drum sprays can force dust out away from the cutting drum, allowing it to mix with the primary airflow and spread into the walkway [Jankowski and Colinet 2000]. Increasing water quantity without increasing water pressure can be accomplished by installing spray nozzles with larger orifices, which provide greater flow for a given operating pressure.

Earlier research indicated that shearer drum water sprays are very effective at minimizing drum-generated dust, but increasing the water spray pressure above 100 psi increased the shearer operator's dust exposure by as much as 25% [Shirey et al. 1985]. However, when considering the

production levels on current longwalls, several mine operators indicated that increasing drum water pressure above 100 psi is necessary to sufficiently penetrate and wet the cut coal volume. Also, the higher air velocities noted above help to confine dust from the shearer drums closer to the face as it moves along the shearer. NIOSH surveys at 10 longwalls in the 2000s indicated that the average drum spray pressure was approximately 150 psi [Rider and Colinet 2011].

### Bit Maintenance

Previous research shows that bits with large carbide inserts and a smooth transition between the steel shank and the carbide reduce dust levels [Organiscak et al. 1996]. A dull bit or a bit missing the carbide tip as shown in Figure 3.20 grinds against the coal, resulting in ineffective use of the available cutting force and the inability to penetrate the coal at designed rates. This results in shallow cutting, which greatly increases dust generation. There is also a higher chance for mechanical damage of bit holders and for frictional ignition of methane [Jankowski et al. 1986; Shirey et al. 1985]. Therefore, the prompt replacement of damaged, worn, or missing bits is essential.

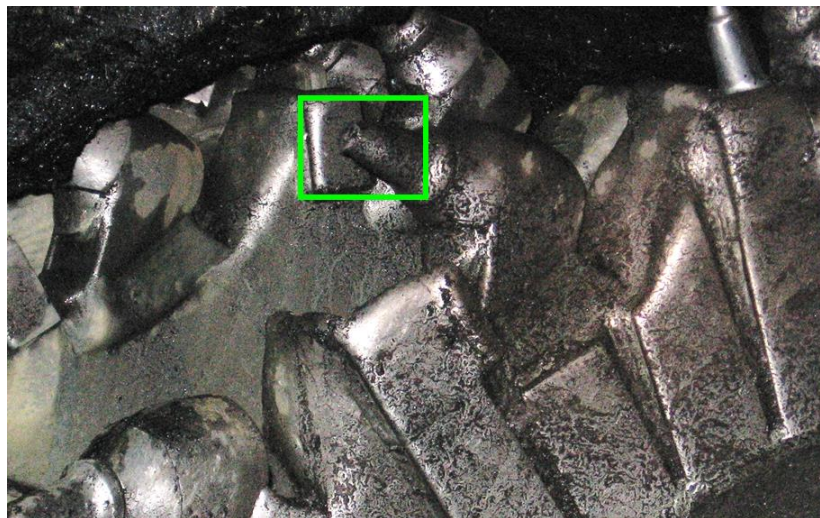

Photo by NIOSH

**Figure 3.20. Dull shearer bit missing carbide insert.**

### Directional Water Spray Systems

Water sprays can be very efficient air movers and, if applied properly, can be used to augment the primary airflow and reduce the amount of shearer-generated dust that migrates into the walkway near the shearer. Water sprays mounted on the shearer body act similarly to small fans, moving air and entraining dust in the direction of their orientation [Jankowski and Colinet 2000]. Poorly designed shearer-mounted spray systems with nozzles directed upwind can force dust away from the face, where it is carried out into the walkway over the shearer operators. A directional spray system, commonly called the shearer-clearer, takes advantage of the air-moving capabilities of water sprays to confine shearer-generated dust against the face until it moves beyond the shearer [Jayaraman et al. 1985]. Results from a series of underground tests showed that the shearer-clearer spray system reduced operator exposure from shearer-generated dust by about 50% when cutting against face ventilation and by at least 30% when cutting with ventilation [Ruggieri et al. 1983; Jayaraman et al. 1985].

The goal of the directional spray system is to maintain the intake air flowing down the walkway, while the shearer-generated dust is confined in the air moving along the face. This desired air split is achieved and maintained through the combination of a physical barrier located on the headgate side of the shearer and numerous downwind-oriented sprays mounted across the length of the shearer. The air split is initiated by the physical barrier, known as a splitter arm, that extends from the walkway side of the shearer body parallel to the headgate ranging arm. In addition, water sprays are mounted on top of the splitter arm to induce airflow and dust movement toward the coal face as shown in Figure 3.21.

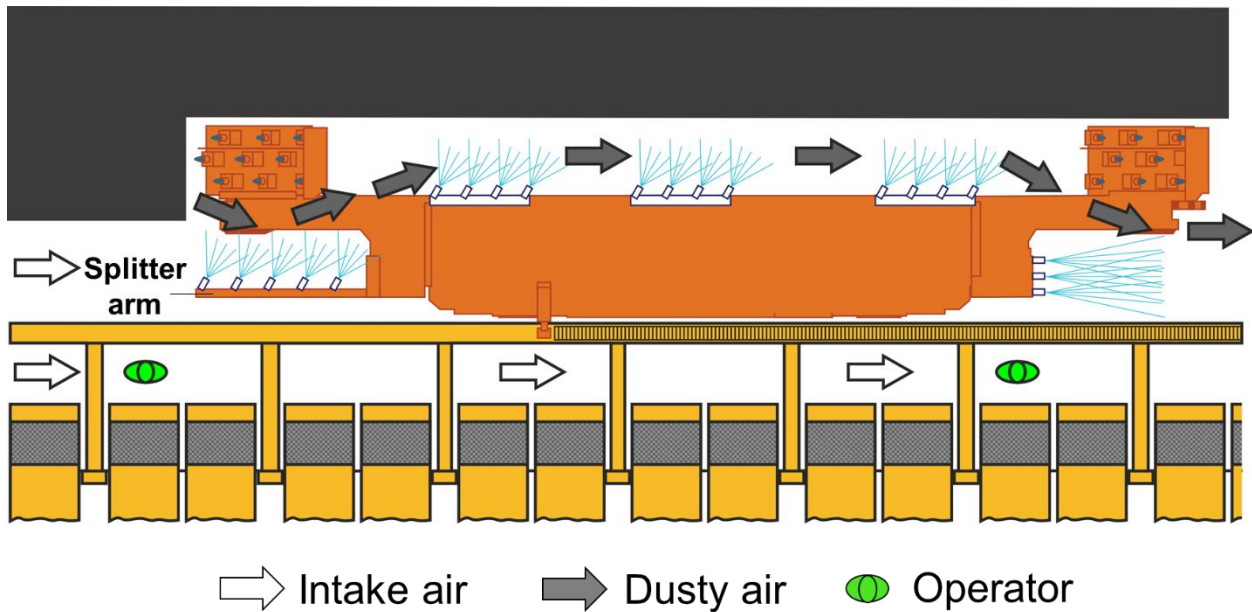

**Figure 3.21. Shearer-clearer directional spray system on longwall shearer.**

To maximize the redirection of dust generated by the headgate drum, the splitter arm should extend as far beyond the drum as possible but be at least parallel to the drum. Since the splitter arm should be as long as possible, it should be made from sufficiently rigid steel tubing or pipe to withstand coal and rock impacts from the face. Alternatively, splitter arms can be mounted with large springs so that the arm can absorb a blow and bounce back into position.

Belting must be hung from the splitter arm down to the panline to help separate face airflow and confine dust in the panline. As coal loaded by the headgate drum falls into the panline, it displaces air and tries to force this dust-laden air into the walkway. The belting acts as a physical barrier to prevent this dust from moving into the walkway. Consequently, tears or gaps in the conveyor belting greatly compromise the effectiveness of the splitter arm by allowing dust to move into the walkway and should be repaired immediately.

The physical separation provided by the splitter arm is augmented with sprays mounted along the top of the arm. All splitter arm sprays should be oriented with the airflow, and enough sprays should be used to prevent dust from moving into the walkway at this location. Since directional spray systems are attempting to move air, the operating pressure is critical and pressures of at least 150 psi should be used. Hollow cone or venturi sprays as shown in Figure 3.22 are effective for use on the splitter arm. The sprays should be oriented to help move dust along the face

without causing turbulence. It is not desirable to have high-pressure sprays directly impacting the ranging arm.



Photo by NIOSH

**Figure 3.22. Venturi sprays mounted on headgate splitter arm.**

At a mine surveyed by NIOSH, additional sprays were mounted on the walkway side of the splitter arm and directed down along the side of the belting and appeared to help limit dust migration into the walkway. Flat fan sprays were spaced evenly along the length of the splitter arm as shown in Figure 3.23. These sprays provided a water barrier on the face-side of the splitter arm belting and assisted in controlling any dust that may have passed under the belting.



Photo by NIOSH

**Figure 3.23. Flat fan sprays mounted on walkway side of belting on the headgate splitter arm.**

In the directional spray systems, dust-laden air is confined near the face and moved along the body of the shearer by air spray manifolds positioned between the drums, as shown in Figure 3.24. Three or four manifolds containing three to five sprays each are typically spaced along the length of the shearer body. These manifolds are either located on the face side of the shearer near the top of the shearer body or on the top of the shearer body close to the face. All sprays are oriented downwind.



Photos by NIOSH

**Figure 3.24. Directional spray manifolds mounted on face side of shearer body as viewed from the headgate (left) and tailgate (right) sides of the shearer.**

When originally designed, directional spray systems were equipped with a splitter arm on the tailgate end of the shearer [Jankowski et al. 1986]. Like the headgate splitter arm, the tailgate arm was equipped with belting and sprays to create a clean air envelope at the tailgate drum that extended several shields downwind of the drum. This envelope was created to reduce the dust exposure of the tailgate shearer operator and jacksetter when advancing shields near the shearer. Because of difficulty in maintaining the tailgate-side splitter arm, its use has declined.

However, a similar benefit was observed by NIOSH at mines that installed a spray manifold on the tailgate end of the shearer as in the example shown in Figure 3.25. These sprays should be oriented parallel to the tailgate ranging arm or angled slightly toward the tailgate drum and act as a water curtain confining the dust cloud near the face. It is important that these sprays confine the dust along the face and not cause excessive turbulence that could cause dust to migrate away from the cutting drum and into the walkway. When operated at elevated pressures of 150 psi or greater with full cone sprays, these nozzles projected water droplets 10–20 ft downwind of the shearer, providing additional protection along three to four shields downwind of the tailgate drum.



Photo by NIOSH

**Figure 3.25. Sprays mounted on tailgate end of shearer body and directed parallel to ranging arm.**

### Headgate Splitter Arm Positioning

Maintaining the position of the headgate splitter arm near parallel is critical for keeping dust from boiling out into the walkway, particularly for higher-seam longwalls that are typically found in the western U.S. During past surveys, NIOSH personnel observed a splitter arm for which the height of the arm could be hydraulically adjusted [Rider and Colinet 2007]. During head-to-tail cutting passes, the splitter arm was angled down toward the panline, allowing respirable dust to migrate over the top of the splitter arm and into the walkway as depicted in Figure 3.26, left. As mining advanced toward the headgate, the cutting drum was in the raised position and the splitter arm was angled upward as shown in Figure 3.26, right. In this position, the belting mounted on the splitter arm was not long enough to reach to the panline, which allowed dust to pass under the belting and up into the walkway. Positioning the splitter arm to be level with the shearer body and parallel to the floor may prevent the dust cloud from migrating over or under the splitter arm and into the walkway.

If dust is passing over the splitter arm when it is level with the shearer body, additional sprays can be installed on the splitter arm with a greater upward angle to prevent this dust from reaching the walkway. Care must be taken to ensure that these sprays are not contacting the underside of the shields, causing turbulence that could interfere with the directional spray system.





**Figure 3.26. Illustrations of splitter arm in a lowered position during the head-to-tail pass (left) and in a raised position during the tail-to-head pass (right). These positions may allow dust to migrate into the walkway on higher-seam longwalls.**

### Shearer Deflector Plates

Shearers operated in high seams can be equipped with hydraulically controlled steel deflector plates that are mounted across the length of the shearer body as shown in Figure 3.27, left. These plates provide protection from debris flying off the face for the shearer operators or other personnel located in the walkway at the shearer. In a raised position, the deflector plates appear to enhance the effectiveness of the directional spray system by providing a physical barrier that helps to confine dusty air close to the face. When used in this manner, the plates should be raised as high as face conditions allow to provide maximum protection. NIOSH personnel have also observed spray manifolds mounted in these deflector plates that supplement the directional water sprays mounted on the shearer body. If these plates are lowered, the shearer operators should turn off the sprays so they do not impact the underside of the shields, creating turbulence that could force dust into the walkway. Figure 3.27, right, shows sprays impacting the shield when the deflector plates are lowered.



Photos by NIOSH

**Figure 3.27. The use of deflector plates to enhance the effectiveness of directional water sprays. A raised deflector plate (left) can enhance the effectiveness of the directional spray system by providing a physical barrier and additional directional sprays. When the deflector plates are lowered, sprays can impact the underside of the shields, creating turbulence (right).**

## Ranging Arm Crescent Sprays

Crescent spray manifolds have been observed on numerous shearers and are located on each ranging arm as shown in Figure 3.28. These manifolds typically extend along the top of the ranging arm and wrap around the end of the arm. It is important that these sprays be aimed inward toward the cutting drum and appropriately spaced to provide uniform wetting of the entire cutting zone. Crescent sprays on the headgate ranging arm should be used with caution. Sprays on the end of the headgate ranging arm are oriented into the face airflow, which can create turbulence that forces dust toward the walkway, particularly if not angled in toward the face [Colinet et al. 1997].



Photos by NIOSH

**Figure 3.28. Crescent sprays mounted on shearer ranging arms.**

## Lump Breaker Sprays

Shearers can be equipped with lump breakers on the tailgate end of the shearer to break large pieces of coal and rock that are trying to pass under the shearer in the face conveyor. Spray manifolds directed at the lump breaker or down onto the face conveyor provide wetting of the coal as it is being broken by the lump breaker [Rider and Colinet 2011]. Using larger-orifice sprays operated at pressures less than 80 psi provides higher volumes of water per spray without creating turbulence, as these sprays should not interfere with the directional spray system.

When all components of a directional spray system are operating as designed, shearer-generated dust can be prevented from reaching the walkway and exposing workers. Figure 3.29 shows how dust can be confined along the face side of the shearer during tail-to-head (left) and head-to-tail cutting passes (right).



Photos by NIOSH

**Figure 3.29. Photos illustrating dust confined near face as seen from the tailgate shearer operator's position on a tail-to-head pass (left) and the headgate shearer operator's position on a head-to-tail pass (right).**

## Controlling Shield Dust

As shield supports are lowered and advanced, crushed coal and/or rock fall from the top of the shield canopy directly into the airstream ventilating the longwall face. Often, this broken material contains very little moisture when compared to the cut coal wetted by the shearer sprays. NIOSH studies quantified increased entrainment when the dust was dry (1% moisture or less) and falling into the ventilating airstream, similar to dust dropping from the shields during advance [Listak et al. 2001; Chekan et al. 2001, 2004]. With increased longwall production, shields are advanced more quickly and more often, which can increase the potential dust release from this source.

Shield advance is now automated and initiated by the shearer position. Shields are typically advanced within two or three shields of the trailing shearer drum. As a result, shield movement can be a significant source of dust exposure for shearer operators when shields are advanced upwind of the shearer during head-to-tail passes. The shields are advanced near the headgate shearer operator, who can be exposed to a concentrated dust cloud as shown in Figure 3.30. A discussion follows on observed spray systems that are available for installation on shields and other potential control strategies.

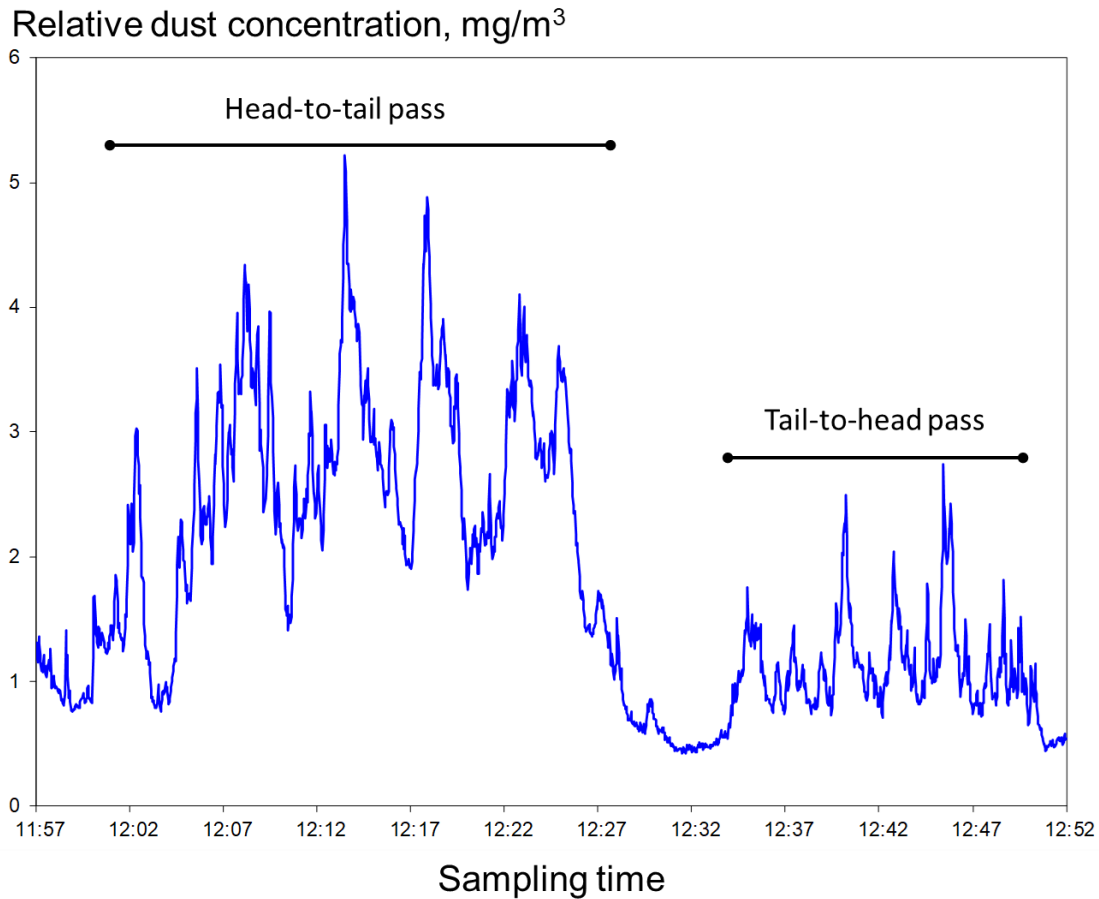

**Figure 3.30. Line graph showing that higher dust levels were observed during the head-to-tail pass as a result of shield-generated dust.**

### Top Canopy Sprays

Most of the dust liberated by shield movement comes from the canopy area of the shields during advance. A canopy spray system that activates sprays discharging into the roof material on top of the shields for a short period of time before and during shield advance has been available for many years. The goal is to wet the material on top of the canopy to lower dust levels during shield advance. Unfortunately, experience shows that this type of system is hard to maintain and may be ineffective in distributing moisture throughout the material located across the top of the shield canopy.

### Underside Canopy Sprays

Shield sprays mounted to the underside of the shields have become more common across longwall operations. These sprays are automatically activated and deactivated by the position of the shearer as it cuts across the face to create a moving water curtain. During field visits, NIOSH observed that mines have these sprays mounted at different locations on the shields which varied from near the tip to near the spill plate. Each shield was equipped with one or two rows of sprays with two sprays in each row. The sequencing of when the sprays were activated and deactivated was mine-specific with no general trend observed.

When the shield sprays were operated at one mine, researchers observed that they had a negative impact on controlling respirable dust associated with the headgate drum. The shield sprays interacted with the upwind splitter arm sprays, creating turbulence that resulted in a dust and mist cloud rolling into the walkway as shown in Figure 3.31. Proper on/off sequencing of these shield sprays is critical for these sprays to augment the directional spray system. Properly aligned sprays directed toward the face with sufficient water pressure and volume have the potential to enhance the envelope of clean air created by the shearer's directional spray system, as discussed in the last section of this chapter.



Photos by NIOSH

**Figure 3.31. Shield sprays located on the underside of the canopy interacting with directional sprays on the shearer (left), allowing dust to move toward the walkway (right).**

### Increased Air Quantity and Distanced Shield Movement

In theory, supplying additional air to the face will increase the dilution of dust liberated by shield advance. However, to increase air quantity coming down the face, a concurrent increase in air velocity must be achieved. Increasing air velocity could provide greater potential for dust entrainment because the relatively dry shield dust falls directly into the airstream.

When shields are advanced within a few shields upwind of the headgate drum during head-to-tail passes, a concentrated dust cloud can be carried directly to the headgate operator's position as shown in Figure 3.30. If the shield advance can be moved as far upwind as possible without creating roof control/operational problems, it would increase the distance and time for the shield dust to reach the shearer operator, allowing for greater mixing and dilution with the intake air [USBM 1984].

### Unidirectional Cutting Sequence

Unidirectional cutting from head-to-tail would allow more workers to be upstream of the dust generated by the shearer and shields than bidirectional cutting [NIOSH 2003]. If suitable roof conditions are present, this may allow the operators to modify the cut sequence so that shields are only advanced downwind of the shearer. Activating shield advance as close to the tailgate drum as possible and keeping jacksetters upwind of the advancing shields would help protect the jacksetters by keeping them in a clean air envelope created by the shearer's directional spray system.

## Emerging Dust Control Technologies

### Fan-powered Shearer Scrubber

Fan-powered flooded bed scrubbers are very successful in reducing respirable dust levels generated by continuous mining machines, as discussed in Chapter 4. Scrubbers were tested on longwall shearers in the past with minimal success. Two factors impact the difference in performance between scrubbers on continuous miners and those tested on shearers.

The first factor is the quantity of face air captured by the scrubber in relation to the total ventilating air quantity. Flooded-bed scrubbers used in the U.S. have a maximum capacity of approximately 20,000 cfm [Defibaugh 2020]. Scrubbers used on continuous miners have the potential to capture all or most of the air ventilating the face. For example, when sampling indicates the quartz limit is exceeded, MSHA limits the face air quantity to no more than 1,000 cfm greater than the scrubber airflow when blowing face ventilation is used [MSHA 2020b]. However, on longwall faces, the face airflow is much greater than the available scrubber capacity, with the average noted earlier of 67,000 cfm. Currently available scrubbers can only capture a relatively small fraction of the face ventilating air. However, if the scrubber inlet could be located to capture the concentrated dust cloud coming from the headgate drum, it would potentially result in notable dust reductions.

Secondly, the flooded bed scrubber was incorporated into the continuous miner body design. Because of the first factor described above and limited space availability on shearer designs, previous scrubber trials on shearers have added the scrubber as an extra component for testing. This often led to damaged systems and less than ideal placement, contributing to a lack of success. Without demonstrated success, mine operators have not requested and shearer manufacturers have not sought to incorporate a scrubber into their shearer designs.

Through funding provided by the Alpha Foundation for the Improvement of Mine Safety and Health [Alpha Foundation 2021], the University of Kentucky completed a shearer-scrubber design. The design incorporated a fan-powered scrubber into a full-scale shearer model. Specifications for a Joy 7 LS shearer were used to construct the full-scale model [Arya et al. 2018]. As shown by the blue sections in Figure 3.32, the shearer body was expanded to implement the scrubber components, including new sections for the scrubber module, a fan module, ductwork, and an optional inlet section that extends onto the ranging arm.

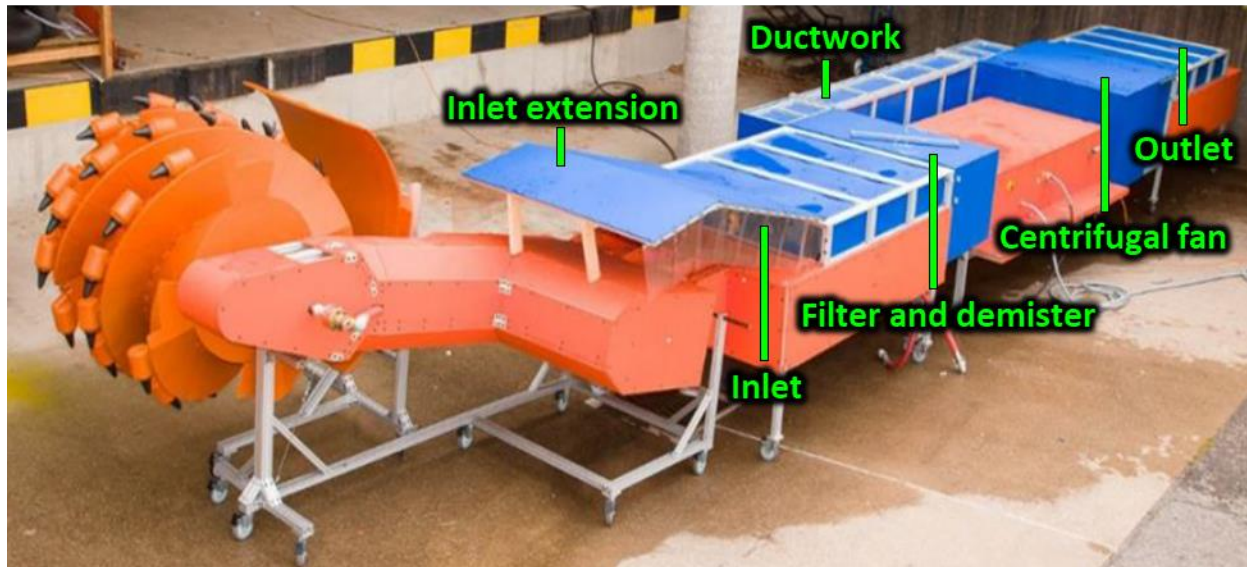
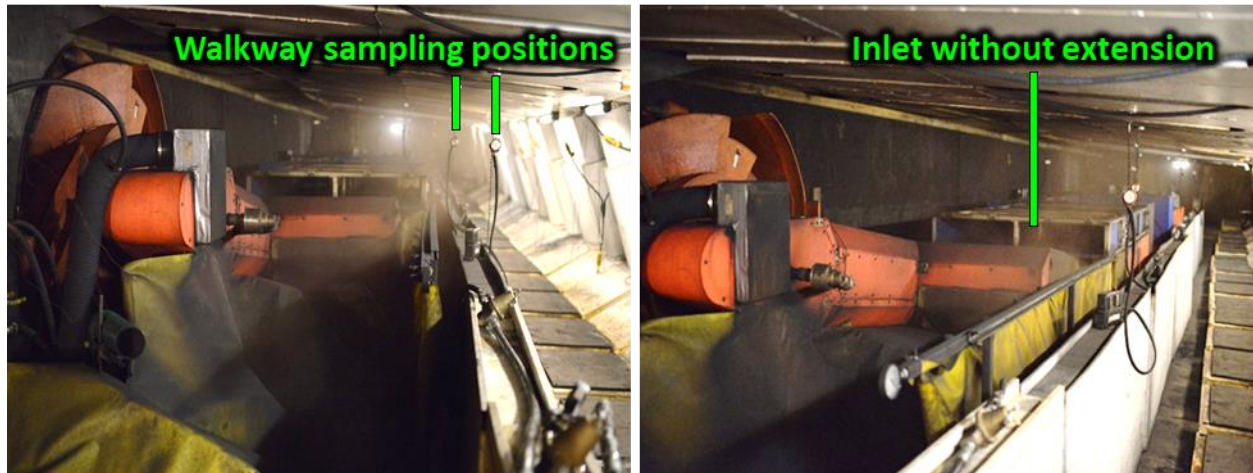

Photo by University of Kentucky

**Figure 3.32. Full-scale shearer model with added scrubber components shown in blue.**

The scrubber unit was equipped with a 50 horsepower fan and had a maximum airflow capacity over 13,000 cfm, when operated with a 20-layer stainless steel mesh filter panel and a water spray flow rate of 6.5 gpm. Testing was conducted in the full-scale NIOSH longwall dust gallery as shown in Figure 3.33. Tests were run with face air velocity in the gallery set at either 500 fpm or 700 fpm, which corresponded to air quantities of approximately 33,000 or 49,000 cfm, respectively. Other conditions evaluated were running the scrubber with and without the inlet extension, and with scrubber airflow at full capacity or approximately 50% capacity. Testing was conducted in multiple stages so that the scrubber was operated without the shearer drum or splitter arms sprays operating, which allowed for isolation of the scrubber performance.

Operation of the scrubber under maximum test conditions (13,000 cfm scrubber airflow, inlet extension, 700 fpm face air velocity) but without operation of the shearer sprays resulted in an average respirable dust reduction of 57%, as measured with four samplers positioned in the return. Four positions were also sampled in the walkway along the length of the shearer with an average respirable dust reduction of 74%. Operation of the shearer splitter arm sprays had minimal impact in the return but increased dust reductions in the walkway to over 90%. These results show that a flooded-bed scrubber installed on the longwall shearer has the potential to substantially reduce respirable dust levels even when it is not capturing most of the face airflow. An integrated scrubber would require redesign of the shearer by the manufacturer in order to provide protection for the necessary components.



Photos by NIOSH

**Figure 3.33. Testing shearer scrubber in NIOSH full-scale longwall dust gallery with sampling locations shown on left and scrubber inlet on right.**

NIOSH initiated research to investigate the quantity of air that can be moved through a water-powered scrubber. If airflows approaching that of the fan-powered scrubber can be achieved, a simpler installation with reduced maintenance needs would be realized and offer a more readily available option.

### Underside Shield Sprays

Often coal slabs spall from the face upwind of the headgate drum as it cuts toward the headgate. The dust released by this coal is typically upwind of the influence of the headgate splitter arm sprays and can carry into the walkway, exposing the shearer operators. After observing seemingly random operation of underside shield sprays at several longwall mines during field visits, NIOSH researchers believed that strategic sequencing of these sprays could be used to, in effect, extend the reach and benefit of the directional headgate splitter arm sprays.

NIOSH tested two flat fan sprays mounted on the underside of shields in the full-scale longwall dust gallery at its Pittsburgh facility as shown in Figure 3.34, left [Klima et al. 2020]. Combinations of three distances from the face (4.5, 5.0, and 5.5 feet), three water pressures (100, 150, and 200 psi), and three spray angles (45, 60, and 75 degrees from the roof) were tested. The impact on respirable dust levels along the panline just upwind of the splitter arm, at the centerline of the headgate drum, and at the ranging arm motor were measured as shown in Figure 3.34, right. These sampling locations represent the general area where the headgate shearer operator is located. The most effective dust reductions were found with the 75° spray angle, 4.5-foot distance, and 200-psi pressure. This combination of operating parameters resulted in respirable dust reductions of over 95% at the upwind and centerline sampling locations and over 70% at the ranging arm motor location. These results demonstrate the potential of using underside shield sprays for controlling dust upwind of the headgate drum. Further evaluation is needed on operating longwalls to demonstrate performance during actual mining conditions.



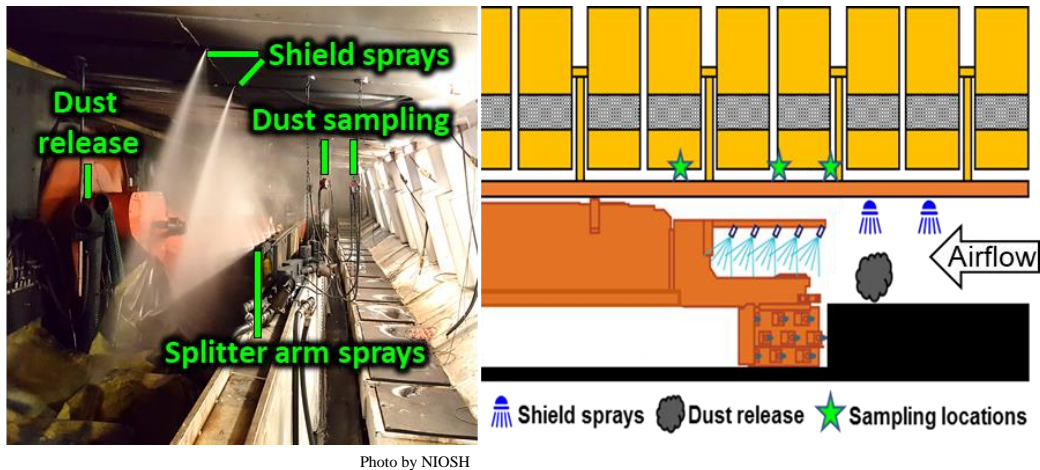

Figure 3.34. Testing in full-scale longwall gallery (left) and sampling locations (right).

## Foam

Several research studies in underground coal operations indicated that applying foam resulted in greater respirable dust control than plain water [Reed et al. 2018]. Foam has a lower surface tension than water and provides a larger contact area with dust particles, while requiring less overall water usage [Wang et al. 2014]. However, the complexity of generating a quality foam, typically with compressed air, was a challenge and added to operational difficulties. Also, the added expense of the additional equipment needed, maintenance of the system, and ongoing expense for chemical additives have hindered foam utilization by the mining industry.

Before using any chemical additives, the potential adverse health effects from inhalation or dermal contact by miners must be evaluated. Also, chemicals added to the mined product have the potential to impact downstream preparation plant functions and must be considered.

In the next section, USBM foam research for shear dust control is discussed. This is followed by newer research by NIOSH which has demonstrated the ability to generate a quality foam without using compressed air. The potential to improve dust control at shields or the stageloader-crusher with this newer foam technology is then discussed.

### *Foam for Controlling Shearer-generated Dust*

Previous USBM research showed that foam can distribute a given quantity of moisture more evenly over a large surface area than water sprays, improving respirable dust control. However, the greatest dust control observed with foam was when a high degree of mixing takes place between the foam and the cut coal.

Two dust surveys (Mines A and B) were conducted with foam discharged from 10 to 12 large-diameter nozzles located in each shearer drum [USBM 1989b]. A third survey (Mine C) was conducted with foam discharged from external sprays mounted on the headgate and tailgate sides of the shearer. No change to the original external sprays was made to any of the shearers in these surveys. Foam reduced shearer operator dust exposure by 56% at Mine A and by 84% at Mine B, while a less than 20% difference was observed at Mine C. The foam systems also used 50% and 30% less water at Mines A and B, respectively. These results illustrate the potential for reducing shearer-generated dust when foam can be applied through the cutting drums.

### Foam for Controlling Shield Dust

Past foam applications in mining used compressed air, water, a foaming agent, and a distribution nozzle or nozzles to generate and apply the foam for dust control purposes. These systems demonstrated that a quality foam could be generated and could reduce respirable dust levels more effectively than water.

Based on the above results, NIOSH researchers envisioned the use of foam as a potential means of reducing dust during shield advance by spraying a foam layer in front of the shield tips after the shearer has cut by this location. The goal is to generate the foam at the shearer and spray the roof with a nozzle or nozzles mounted on top of the shearer body. As the shield advanced into this foam layer, the foam would distribute moisture throughout the crushed material on top of the shield. The added moisture would then reduce respirable dust liberation as the material drops from the shield canopy into the face airstream. The use of traditional foam generation with compressed air for application from the shearer is complex and difficult, so NIOSH investigated alternative foam generation techniques for use on the shearer.

NIOSH research demonstrated that a suitable foam can be generated without compressed air using a blower, a NIOSH-developed foam generator, and 3-D printed nozzle [Reed et al. 2017]. Initial testing demonstrated this system's ability to generate a foam that had the same or greater expansion ratio and moisture retention as foam generated with compressed air. A simulated test roof was then constructed with the foam generator moving at 40 fpm, to simulate shearer movement, in a ventilating air velocity of 650 fpm, as shown in Figure 3.35, left. This testing showed the success and stability of the foam application. Subsequent testing to evaluate potential dust reductions with the foam was conducted in a specially constructed test stand shown in Figure 3.35, right. Dust levels were measured with three sampling instruments positioned across the test stand nine feet downwind of the simulated shield movement. Average dust levels were calculated for three different foaming agents and at two air velocities [Reed et al. 2021]. Results indicated that at a face airflow of 600 fpm, average dust reductions of 79%, 64%, and 60% were observed for foaming agents A, B, and C, respectively. At 1,000 fpm air velocity, foaming agent C had a 53% respirable dust reduction while agents A and B had reductions of 26% and 9%, respectively. These results demonstrate the potential of using foam for controlling shield dust but require further evaluation at operating longwalls to document performance.



Photo by NIOSH

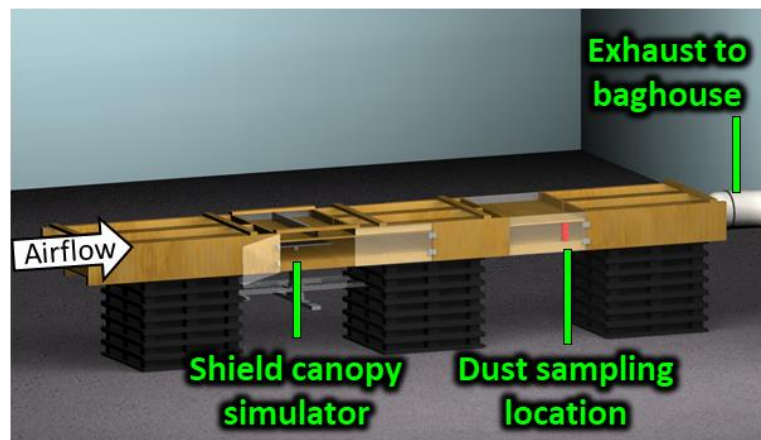

Illustration by NIOSH

**Figure 3.35. Foam generator spraying onto roof (left) and stand used to test dust reduction with three foaming agents (right).**

## References for Chapter 3

79 Fed. Reg. 24814 [2014]. Mine Safety and Health Administration: Lowering miners' exposure to respirable coal mine dust, including continuous personal dust monitors; final rule. To be codified at 30 CFR Parts 70, 71, 72, 75, and 90.

Allen RG [1983]. A conveyor belt dust control system using a belt wiper. In: Barrett JA, Jacobson M, Sutherland WH, Tinney GR, Turcic PM, ed. Proceedings of the Symposium on Control of Respirable Coal Mine Dust, Beckley, WV: Mine Safety and Health Administration, pp. 187–191.

Alpha Foundation [2021]. Alpha Foundation for the Improvement of Mine Safety and Health, Inc. <https://www.alpha-foundation.org/>

Arnott W [2019]. A guide to conveyor belt cleaning solutions. Bulk Handling Review, March 6, 2019. <https://www.bulkhandlingreview.com.au/a-guide-to-conveyor-belt-cleaning-solutions/>

Arya S, Sottile J, Rider JP, Colinet JF, Novak T, Wedding C [2018]. Design and experimental evaluation of a flooded-bed dust scrubber integrated into a longwall shearer. Powder Tech 339(11):487–496.

Baig NA, Dean AT, Skiver DW [1994]. Successful use of belt washers. In: Proceedings of the American Power Conference. Chicago, IL. Illinois Institute of Technology, pp. 976–978.

Beck T, Klima S, Seaman C [2020]. Dust control at a belt conveyor transfer point using water sprays and a wetting agent. SME Annual Meeting, Phoenix, AZ, Feb 24-26, Preprint No. 20-110.

Breuer H [1972]. Progress in dust and silicosis control. Glückauf 108(18):806–814.

CFR. Code of Federal regulations. Washington, DC: U.S. Government Printing Office, Office of the Federal Register.

Chekan GJ, Listak JM, Colinet JF [2001]. Laboratory testing to quantify dust entrainment during shield advance. In: Proceedings of the Seventh International Mine Ventilation Congress (Krakow, Poland, June 17–22, 2001), pp. 291–298.

Chekan GJ, Listak JM, Colinet JF [2004]. Factors impacting respirable dust entrainment and dilution in high-velocity airstreams. In: Yernberg WR, ed. Transactions of Society for Mining, Metallurgy, and Exploration, Inc. Vol. 316. Littleton, CO: Society for Mining, Metallurgy, and Exploration, Inc., pp. 186–192.

Colinet JF, Spencer ER, Jankowski RA [1997]. Status of dust control technology on U.S. longwalls. In: Ramani RV, ed. Proceedings of the Sixth International Mine Ventilation Congress. Chapter 55. Littleton, CO: Society for Mining, Metallurgy, and Exploration, Inc., pp. 345–351.

Conflow [2020]. Venturi sprays code 1912. <http://www.conflow.com/pdf/CODE%201912.pdf>

Courtney WG [1983]. Single spray reduces dust 90 pct. Coal Mining and Processing 20(6):75–77.

Cowherd C, Muleski GE, Kinsey JS [1988]. Control of open fugitive dust sources. Final report, EPA-450/3-98-008. Midwest Research Institute, Kansas City, MO, EPA Contract No. 68-02-4395.

[https://www3.epa.gov/ttn/chief/old/ap42/ch13/s025/reference/ref\\_10c13s025\\_1995.pdf](https://www3.epa.gov/ttn/chief/old/ap42/ch13/s025/reference/ref_10c13s025_1995.pdf)

Cowherd, Jr. C [1990]. Open fugitive dust—PM10 sources and controls. EPA-OAQPS, Sacramento, CA.  
<https://nepis.epa.gov/Exe/ZyPDF.cgi/94000PUK.PDF?Dockey=94000PUK.PDF>

Defibaugh J [2020]. E-mail message from Joe Defibaugh, PDTC Group Leader, Komatsu Mining Corp. to Jay Colinet, NIOSH, May 18.

Defibaugh J [2021]. E-mail message from Joe Defibaugh, PDTC Group Leader, Komatsu Mining Corp. to Jay Colinet, NIOSH, January 4.

Doney BC, Blackley D, Hale JM, Halldin C, Kurth L, Syamlal G, Laney AS [2019]. Respirable coal mine dust in underground mines, United States, 1982–2017. *Am J Ind Med* 62(6):478–485.

EIA [2019]. Annual coal report 2018. Washington DC: U.S. Department of Energy, Energy Information Administration. <https://www.eia.gov/coal/annual/pdf/acr.pdf>

EIA [2020]. Annual coal report (multiple years accessed). Washington DC: U.S. Department of Energy, Energy Information Administration. <https://www.eia.gov/coal/annual/>

Fiscor S [2019]. Longwall production remains steady; 2019 U.S. longwall census. *Coal Age* 124(1):24–28.

Grigal D, Ufken G, Sandstedt J, Blom M, Johnson D [1982]. Development of improved scrubbers for coal mine applications. U.S. Bureau of Mines OFR 91-83, NTIS PB 83-205385.

Jankowski RA, Kissell FN [1983]. Improved face ventilation lowers longwall dust levels. In: *Transactions of Society for Mining, Metallurgy, and Exploration, Inc.* Vol. 274. Littleton, CO: Society for Mining, Metallurgy, and Exploration, Inc., pp. 2024–2028.

Jankowski RA, Kissell FN, Daniel JH [1986]. Longwall dust control: an overview of progress in recent years. *Min Eng* 28(10):953–958.

Jankowski RA, Colinet JF [2000]. Update on face ventilation research for improved longwall dust control. *Min Eng* 52(3):45–52.

Jayaraman NI, Jankowski RA, Kissell FN [1985]. Improved shearer-clearer system for double-drum shearers on longwall faces. Pittsburgh, PA: U.S. Department of the Interior, Bureau of Mines, RI 8963. NTIS No. PB 86-107844.

Kelly J, Ruggieri S [1990]. Evaluate fundamental approaches to longwall dust control; subprogram C: Stageloader dust control. Foster-Miller, Inc. U.S. Bureau of Mines contract J0318097. NTIS No. DE 90-015510.

Klima SS, Reed WR, Driscoll JS, Mazzella AL [2020]. A laboratory investigation of underside shield sprays to improve dust control of longwall water spray systems. *Mining, Metallurgy & Exploration*, published online November 2, <https://doi.org/10.1007/s42461-020-00339-x>

Kost JA, Yingling JC, Mondics BJ [1981]. Guidebook for dust control in underground mining. Bituminous Coal Research Inc. U.S. Bureau of Mines contract J0199046. NTIS No. PB 83-109207.

Lechler [2020]. Solid stream nozzles.  
<https://www.lechlerusa.com/en/products/product-by-type/solid-stream-nozzles/>

Lindahl P ([Lindahl.Philip@DOL.GOV](mailto:Lindahl.Philip@DOL.GOV)) [2015]. RE: Vent/dust plans for LW faces. Private e-mail message to Jay Colinet ([JColinet@cdc.gov](mailto:JColinet@cdc.gov)), NIOSH, July 27.

Listak JM, Chekan GJ, Colinet JF [2001]. Laboratory evaluation of shield dust entrainment in high velocity airstreams. In: Transactions of Society for Mining, Metallurgy, and Exploration, Inc. Vol. 310. Littleton, CO: Society for Mining, Metallurgy, and Exploration, Inc., pp. 155–160.

Meikle GB ([Meikle.Gregory@DOLGOV](mailto:Meikle.Gregory@DOLGOV)) [2020]. RE: Use of belt air for face ventilation. Private e-mail message to Jay Colinet ([JColinet@cdc.gov](mailto:JColinet@cdc.gov)), NIOSH, March 11.

Midwest Research Institute [1981]. Dust control for haul roads. U.S. Department of the Interior, Bureau of Mines Open File Report 130-81.

MSHA [2020a]. MSHA data sets—3. Coal dust samples data set. U.S. Department of Labor, Mine Safety and Health Administration.  
<https://arlweb.msha.gov/OpenGovernmentData/OGIMSHA.asp>

MSHA [2020b]. MSHA data sets—16. Quartz samples. U.S. Department of Labor, Mine Safety and Health Administration. <https://arlweb.msha.gov/OpenGovernmentData/OGIMSHA.asp>

MSHA [2020c]. MSHA Handbook Series, Handbook Number: PH89-V-1 (27), Coal Mine Health Inspection Procedures. U.S. Department of Labor, Mine Safety and Health Administration.

NIOSH [2003]. Handbook for dust control in mining. By: Kissell FN. Pittsburgh, PA: U.S. Department of Health and Human Services, Centers for Disease Control and Prevention, National Institute for Occupational Safety and Health, DHHS (NIOSH) Publication No. 2003-147, Information Circular 9465.

Organiscak JA, Khair AW, Ahmad M [1996]. Studies of bit wear and respirable dust generation. In: Transactions of Society for Mining, Metallurgy, and Exploration, Inc. Vol. 298. Littleton, CO: Society for Mining, Metallurgy, and Exploration, Inc., pp. 1932–1935.

Pollock D, Organiscak J [2007]. Airborne dust capture and induced airflow of various spray nozzle designs. *Aer Sci Tech* 41(7):711–720.

Reed WR, Zheng Y, Klima S, Shahan MR, Beck TW [2017]. Experimental study of foam coverage on simulated longwall roof. In: Transactions of Society for Mining, Metallurgy, and Exploration, Inc. Vol. 342. Littleton, CO: Society for Mining, Metallurgy, and Exploration, Inc., pp. 77–82.

Reed WR, Beck TW, Zheng Y, Klima S, Driscoll J [2018]. Foam property tests to evaluate the potential for longwall shield dust control. *Min Eng* 70(1):35–41.

Reed WR, Shahan MR, Zheng Y, Mazzella A [2021]. Laboratory results of foam application testing for longwall shield dust control in a simulated environment. *Int J Coal Sci Tech*. Published online March 2. <https://doi.org/10.1007/s40789-021-00414-8>

Rider JP, Colinet JF [2007]. Current dust control practices on U.S. longwalls. In: Proceedings of Longwall USA, Pittsburgh, PA, June 5-7.

Rider JP, Colinet JF [2011]. Benchmarking longwall dust control technology and practices. *Min Eng* 63(9):74–80.

Ruggieri SK, Muldoon TL, Schroeder W, Babbitt C, Rajan S [1983]. Optimizing water sprays for dust control on longwall shearer faces. Foster-Miller, Inc. U.S. Bureau of Mines contract J0308019. NTIS No. PB 86-205408.

Schowengerdt FD, Brown JT [1976]. Colorado School of Mines tackles control of respirable coal dust. *Coal Age* 81(4):129–131.

Shankar S, Ramani RV [1995]. Effect of air velocity and walking on the re-entrainment of dust in mine airways. In: *Transactions of Society for Mining, Metallurgy, and Exploration, Inc.* Vol. 298. Littleton, CO: Society for Mining, Metallurgy, and Exploration, Inc., pp. 1834–1838.

Shirey CA, Colinet JF, Kost JA [1985]. *Dust control handbook for longwall mining operations.* BCR National Laboratory. U.S. Bureau of Mines contract J0348000. NTIS No. PB-86-178159/AS.

Spraying Systems Co. [2016]. *Spray technology for dust control.* Bulletin No. 652A. [https://www.spray.com/-/media/DAM/Sales-Materials/b/B652A\\_Spray\\_Technology\\_Dust\\_Control.pdf](https://www.spray.com/-/media/DAM/Sales-Materials/b/B652A_Spray_Technology_Dust_Control.pdf)

Stahura RP [1987]. Conveyor belt washing: Is this the ultimate solution? *TIZ-Fachberichte* 111(11):768–771.

Stahura RP [1997]. The pyramid of effective conveyor dust control: containment, suppression, and collection. *International Materials Handling Conference, BeltCon 9, Midrand, South Africa, October 22–24, Paper 21.*

Swinderman RT, Marti AD, Goldbeck LJ, Marshall D, Strebel MG [2013]. *Foundations: the practical resource for cleaner, safer, more productive dust & material control, Fourth edition.* Neponset, Illinois: Martin Engineering Company.

Tomb TF et al. [1992]. Evaluation of respirable dust control on longwall mining operations. In: *Transactions of Society for Mining, Metallurgy, and Exploration, Inc.* Vol. 288. Littleton, CO: Society for Mining, Metallurgy, and Exploration, Inc., pp. 1874–1878.

USBM [1981]. High-pressure shrouded water sprays for dust control. By Jayaraman NI, Kissell FN, Cross W, Janosik J, Odoski J. Pittsburgh, PA: U.S. Department of the Interior, Bureau of Mines, RI 8536. NTIS No. PB 81-231458.

USBM [1982]. Dust knockdown performance of water spray nozzles. Pittsburgh, PA: U.S. Department of the Interior, Bureau of Mines Technology News 150.

USBM [1984]. Reducing longwall face workers' respirable dust exposure from roof support movement. Pittsburgh, PA: U.S. Department of the Interior, Bureau of Mines Technology News 205.

USBM [1985]. Improved stageloader dust control in longwall mining operations. Pittsburgh, PA: U.S. Department of the Interior, Bureau of Mines Technology News 224.

USBM [1986]. Dust controls to improve quality of longwall intake air. By Organiscak JA, Jankowski RA, Kelly JS. Pittsburgh, PA: U.S. Department of the Interior, Bureau of Mines, IC 9114. NTIS No. PB 87-167573.

USBM [1989a]. Basic parameters of conveyor belt cleaning. By Rhoades CA, Hebble TL, Grannes SG. U.S. Department of the Interior, Bureau of Mines Report of Investigations 9221.

USBM [1989b]. Novel foam application lowers longwall dust. Pittsburgh, PA: U.S. Department of the Interior, Bureau of Mines Technology News 326.

USBM [1992]. Dust considerations when using belt entry air to ventilate work areas.  
By Potts JD, Jankowski RA. Pittsburgh, PA: U.S. Department of the Interior, Bureau of Mines,  
RI 9426.

Wang H, Wang D, Wang Q, Jia Z [2014]. Novel approach for suppressing cutting dust using  
foam on a fully mechanized face with hard parting. *J Occ Env Hyg* 11(3):154–164.

## CHAPTER 4: CONTROLLING RESPIRABLE DUST ON CONTINUOUS MINING SECTIONS

Historically, average dust concentrations found on continuous miner sections have been lower than those found on longwall sections. Figure 3.1 shows that this trend has continued over the past 10 years. However, exposure to respirable crystalline silica (quartz) dust is a major concern on continuous mining sections, with the largest source of this quartz typically being the rock strata overlaying (Figure 4.1, left) or underlying the coal seam. For continuous mining operations, extraction of this rock is often needed for equipment clearance but can lead to increased dust generation as shown in Figure 4.1, right [Beck et al. 2016]. Likewise, roof bolter operators must drill into roof rock in order to anchor roof supports.

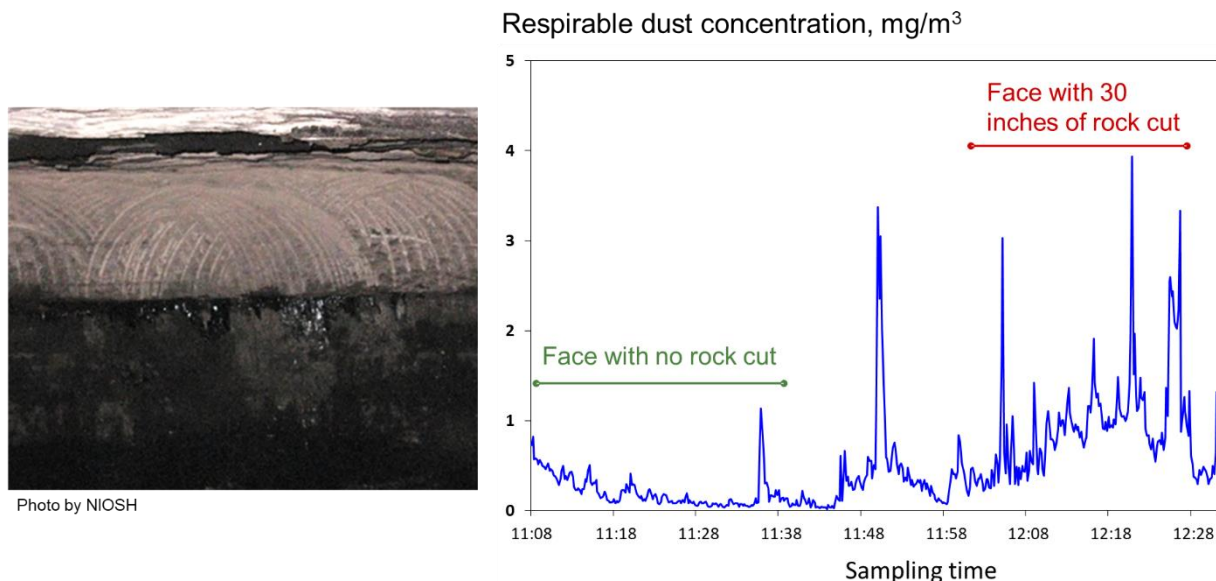

**Figure 4.1. Photo (left) showing approximately 18 inches of roof rock extracted as part of mining and line graph (right) showing increased respirable dust generation when mining rock.**

To illustrate the concern with exposure to respirable quartz on continuous mining sections and the increasing impact on miners' health, three NIOSH studies are discussed. In the first study, 19 former miners that worked in Central Appalachian mines and had been diagnosed with severe lung disease (progressive massive fibrosis) were interviewed to learn about their work history [Reynolds et al. 2018]. Sixteen of these miners indicated that their primary jobs were operating continuous miners (7) or roof bolters (9), with two other miners indicating they did a combination of these jobs. In the second study that was initially cited in Chapter 1, health surveillance data indicates that quartz's contribution to lung disease in miners from the Central Appalachian mining region has increased over the last several decades [Hall et al. 2019]. This region has a large concentration of continuous mining operations with this health data suggesting that as time has passed more rock is being extracted as the more desirable seams have been mined out. In the third study, NIOSH researchers collected information from Mine Safety and Health Administration (MSHA) inspector reports on the operating conditions at 67 mines in the Central Appalachian region [Pollock et al. 2010]. MSHA inspector data indicated that rock extraction typically accounted for between 20% and 30% of the mining height, with over half of the mines in this region on a reduced dust standard due to elevated quartz levels. Therefore,



controlling the quartz exposure for continuous miner (CM) and roof bolter (RB) operators must be a high priority.

Since passage of the Federal Coal Mine Health and Safety Act of 1969, federal coal mine inspectors have collected respirable dust samples that are analyzed for quartz content. From 1970 until the enactment of the 2014 dust rule [79 Fed. Reg. <sup>15</sup> 24814 (2014)], samples containing greater than 5% quartz were considered excessive and triggered calculation of a reduced dust standard for the mining section from which the sample was collected. On continuous mining sections, the high risk and most frequently sampled occupations were the CM operator, normally identified as the designated occupation (DO) sample, and the RB operator, normally identified as the designated area (DA) sample. Therefore, the 5% quartz metric will be used to assess the quartz content of respirable dust samples collected from CM and RB operators.

In an MSHA publication, inspector samples collected from 1988 through 1992 for RB operator occupations (twin-head RB intake and return side operators, mounted RB intake and return side operators, and single-head RB operators) and CM operators were analyzed for samples containing more than 5% quartz [Ainsworth et al. 1995]. NIOSH analyzed publicly available MSHA inspector samples collected from 2000 through 2020 for CM and RB operator samples containing more than 5% quartz [MSHA 2020a]. Data was omitted for the time period when sampling was transitioning from the implementation of the initial parts of the 2014 dust rule (August 1, 2014) to the lowering of the dust standard (August 1, 2016). The RB operator samples downloaded from the MSHA website contained the five RB occupations mentioned above. Figure 4.2 shows the percentage of inspector samples for CM and RB operators that contained greater than 5% quartz. For all periods, RB operator occupations experienced a higher percentage of samples exceeding 5% quartz than the CM operators. Notable increases for the RB operator samples were seen in the 2000s, before percentages for both RB and CM operators dropped in the 2010s. This data indicates that a substantial percentage of samples for these occupations have contained more than 5% quartz throughout this period.

Consequently, in MSHA's 2014 dust rule, the CM operator was specified as the DO and the RB operator as the other designated occupation (ODO) that must be sampled by mine operators on CM sections. Fifteen valid respirable dust samples must be collected on consecutive shifts for the DO and then the ODO each quarter. In addition, previous sampling data including NIOSH sampling [NIOSH 2011] has shown that haulage car operators (e.g., shuttle cars, ram cars) can be exposed to elevated dust levels when being loaded by the CM in sections using blowing ventilation. As a result, MSHA also requires the collection of 15 valid samples for haulage car operators in these sections. As part of this dust rule, a reduced dust standard is now calculated when a sample contains over 100 micrograms per cubic meter of air ( $\mu\text{g}/\text{m}^3$ ) of quartz as compared to the 5% quartz criteria previously discussed. The reduced dust standard is calculated with the same formula ( $10 \div \% \text{ quartz}$ ) as mentioned in Chapter 1, but the reduced standard cannot exceed the 1.5 milligrams per cubic meter of air ( $\text{mg}/\text{m}^3$ ) new dust standard.

---

<sup>15</sup> Federal Register. See Fed. Reg. in references.

## Inspector samples containing greater than 5% quartz, %

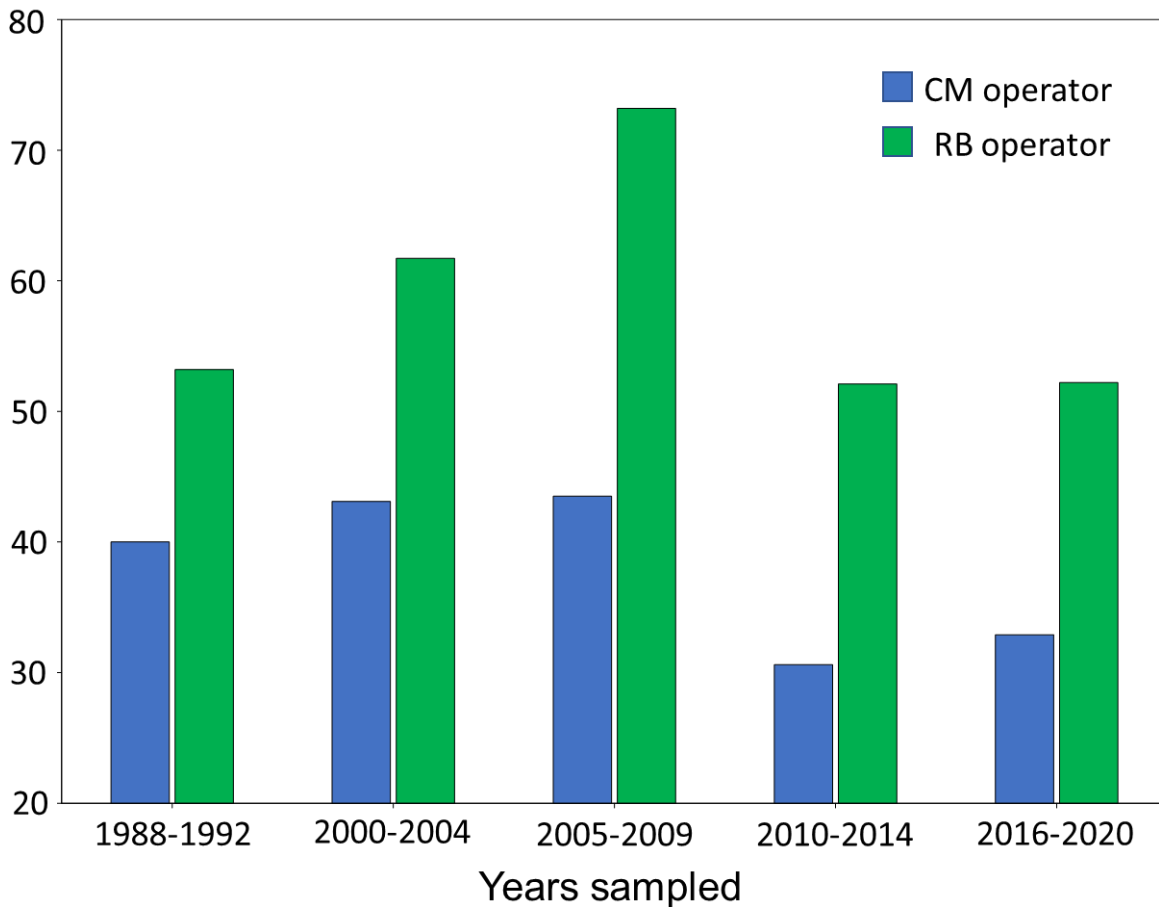

**Figure 4.2. Percentage of MSHA inspector dust samples analyzed for quartz from continuous miner and roof bolter operators that contained greater than 5% quartz.**

The two greatest sources of respirable dust exposure on CM sections are typically the CM and the RB. As noted in Chapter 3, ventilating air and water are the primary controls used to dilute, suppress, redirect, or capture dust in underground coal mining operations. In addition to these primary controls, powered dust collectors on CMs and RBs provide supplemental controls that have been proven to be highly effective in controlling respirable dust liberation from these machines. In this chapter, discussion of ventilation, water sprays, and powered dust collectors will be provided, along with information on other dust sources and controls found on continuous mining sections.

### Section Ventilation

Ventilating air is supplied to underground coal mines to provide fresh air for the miners to breathe and to dilute and remove airborne contaminants. For continuous mining sections, federal regulations [30 CFR 75.325 ] require a minimum air quantity at each working face of 3,000 cubic feet per minute (cfm), with a minimum quantity of 9,000 cfm required at the last open crosscut. Often, mining operations supply greater quantities of ventilating air at both locations, and these greater quantities are specified in a ventilation plan that must be approved by

MSHA. The ventilation plan quantities then become the minimum acceptable quantities and must be maintained or exceeded at all times. However, one goal of MSHA’s quarterly dust sampling surveys is to demonstrate that the dust control parameters specified in the ventilation plan are protective. Therefore, MSHA will request that the mine operators adjust elevated airflow levels so that they do not exceed 120% of the values in their plans during MSHA dust sampling [MSHA 2020b].

Section ventilation can be provided in single-split (also called sweep ventilation) or double-split (also called fish-tail or T-split ventilation) configurations as shown in Figure 4.3. In single-split ventilation, intake air is brought in on one side of the section and sweeps across all faces before exiting in the return on the other side of the section. When the continuous miner is operating in the main intake entry, all faces downwind would be in the dusty return air from the miner as shown in Figure 4.3, left. For double-split ventilation, intake air is brought in the center entry or entries and split into two branches. One branch will ventilate the left-side entries while the second branch will ventilate the right-side entries. For mines operating two CMs on the same section (called super sections), double-split ventilation provides an intake airstream to both CMs which prevents the dust generated by one CM from being carried to the second CM operator as shown in Figure 4.3, right.

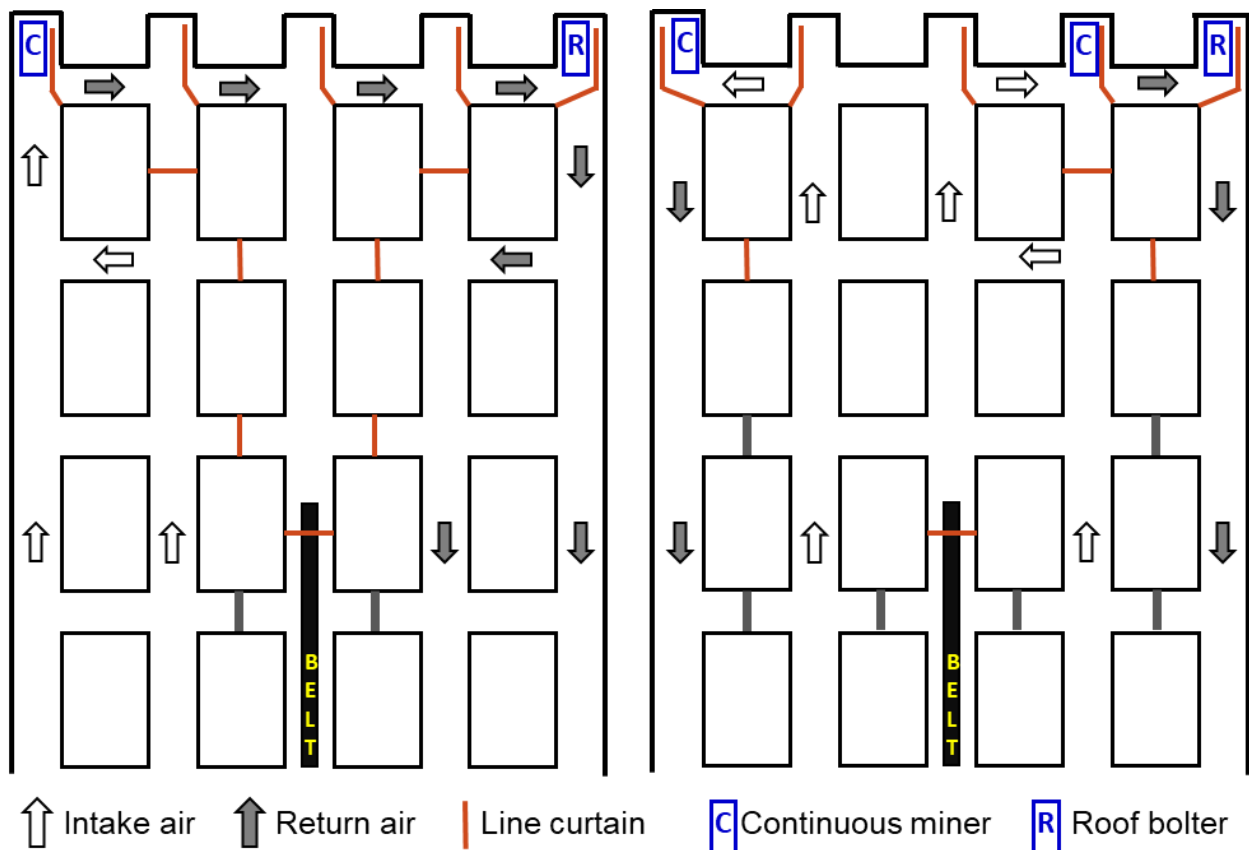

**Figure 4.3. Single-split (left) and double-split (right) face ventilation for continuous mining sections.**

Ventilating air may be directed to the face with either line curtain or tubing when auxiliary fans are used. To demonstrate compliance with the ventilation plan, air quantity measurements must be taken at or near the face end of the line curtain or tubing. If the CM is equipped with a machine-mounted dust collector (flooded-bed scrubber), MSHA regulations [30 CFR 75.325(2)] require that the scrubber fan is off when measuring the face airflow quantity. Mining cannot begin if the minimum air quantity specified in the ventilation plan is not supplied to the face, and adjustments must be made to obtain the required quantity.

Exhausting or blowing face ventilation patterns can be used to supply air to the mining faces. Each of these ventilation types and their impact on respirable dust exposures are discussed later in this chapter.

### Intake Air Dust Control

Beginning on August 1, 2016, as part of its 2014 dust rule, MSHA requires the average concentration of respirable dust in intake air to be maintained at or below  $0.5 \text{ mg/m}^3$  within 200 ft outby the working faces. Maintaining this concentration requires attention from mine operators to address activities that can raise intake air dust levels. Typically, high levels of intake dust are sporadic and result from activities in the intake entries that may take place over the course of a working shift. These activities can include:

- delivery of supplies and/or personnel
- moving equipment in intake entries
- rock dusting
- scoop movement
- construction activities

To eliminate these sources of dust generation, these outby activities should be completed on nonproduction shifts when possible. Wetting the roadway or chemical application as discussed in Chapter 3 may be necessary if dry material on the floor is being disturbed and entrained into the ventilating air.

The belt entry can be used to bring intake air to the working faces but is a potential source of dust generation. Research by the United States Bureau of Mines (USBM) measured the dust level impact of using belt air for face ventilation on continuous mining sections [USBM 1992a]. Controls at the belt head helped maintain low dust levels in the belt entry. Automated sprays were used to suppress dust at the section-to-main belt transfer point. A belt scraper equipped with sprays controlled dust by cleaning the outside surface of the belt after the coal had been transferred to the main belt. These control measures are discussed in more detail in Chapter 3.

Dust measurements show that feeder-breaker operations can contribute an undesirable amount of respirable dust into the mine air, which emphasizes the need for dust controls at this location [USBM 1992a]. Also, another USBM study of outby areas showed that the highest respirable silica dust concentrations were found at the feeder-breaker and averaged nearly  $50 \text{ } \mu\text{g/m}^3$  from the mines that were sampled [USBM 1990a].

The following are some basic controls for reducing dust at the feeder-breaker:

- MSHA recommends using full cone sprays at the feeder-breaker to wet coal and silica dust and hollow cone sprays to knock down airborne dust [Ondrey et al. 1995].

- Dust levels can be decreased by using automated sprays at the feeder-breaker that activate during shuttle car unloading to wet the coal before it enters the breaker.
- Throat sprays on the CM will wet coal when entering the conveyor and lessen dust when transferred to the shuttle car. If sufficient moisture has been added by these sprays, it will help to minimize dust liberation as the shuttle car empties at the feeder-breaker. Redistributing a portion of the water available on the CM may be necessary to ensure that the loaded coal contains sufficient moisture [Ondrey et al. 1995].

### Exhausting Face Ventilation

When exhausting ventilation is used, intake air is delivered to the face in the working entry as illustrated in Figure 4.4. The intake air sweeps the face and the dust-laden air is then drawn behind the return curtain or through exhaust tubing and carried to the return entries. This system allows most of the mining entry to be in intake air, which is beneficial for the respirable dust exposure for all personnel in the face entry. However, research has shown that exhaust face ventilation airflow does not penetrate as deeply into the face as blowing ventilation, particularly as curtain setback distance increases [USBM 1969]. This may be a concern for controlling methane emissions in gassy operations, especially when taking extended cuts of up to 40 feet. The airflow patterns in Figures 4.4 and 4.5 are somewhat exaggerated to emphasize the difference in penetration into the face between exhausting and blowing face ventilation.

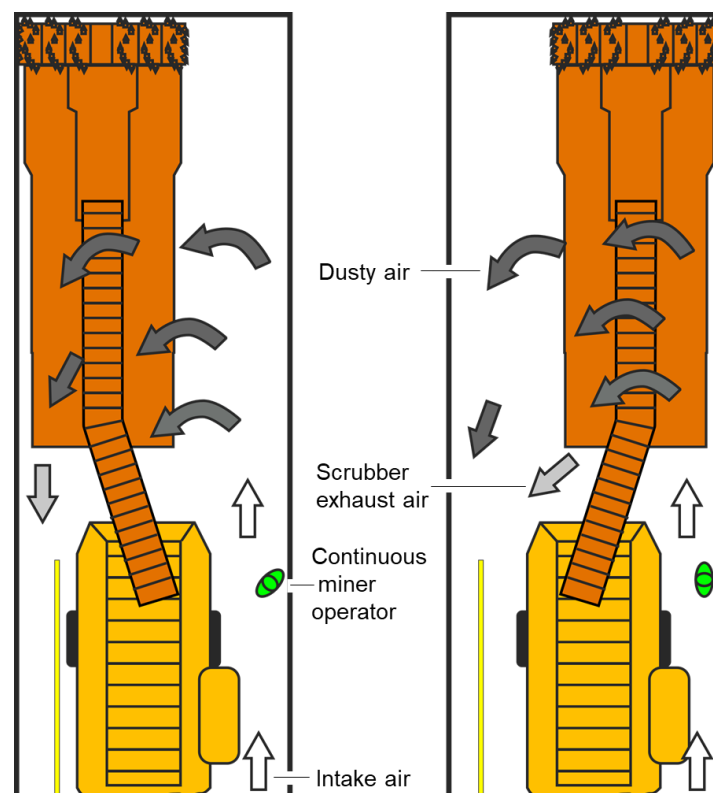

**Figure 4.4. Schematic of exhaust face ventilation system showing desired operator positioning for cuts taken on the left (left) and right (right) side of the entry.**

Exhaust face ventilation allows haulage car operators to remain in intake air while the car is being loaded behind the continuous miner. This ventilation also affords the CM operator more

freedom of movement than a blowing ventilation system, but it is recommended that the operator should be positioned on the off-curtain side of the entry [Schultz and Fields 1999]. This keeps the operator as far away as possible from the dust-laden air that is moving toward the return curtain or tubing. An added safety benefit of the CM operator being on the opposite side of the entry from the curtain is that haulage car operators can more easily see the CM operator as their cars enter the face area. However, good communication between the CM operator and haulage car operators is essential for safe operation, regardless of the face ventilation being used. Also, the CM operator must be aware of the swing range of the loading boom and remain a safe distance away as shown in Figure 4.4, right.

The following practices will help reduce dust exposure on exhausting ventilation sections:

- MSHA regulations require that mean entry air velocity reaching the face must be at least 60 feet per minute (fpm) when using exhaust ventilation systems [30 CFR 75.326]. This velocity will help prevent dust generated at the CM cutting head from rolling back into the entry. A lower mean entry air velocity may be approved by MSHA in the ventilation plan if that velocity is demonstrated to be capable of maintaining methane and respirable dust at required levels.
- The end of the line curtain or tubing should be outby the scrubber discharge to prevent redirecting the scrubber exhaust into the intake air.
- The CM operator should be positioned parallel to or outby the end of the line curtain or tubing. This will reduce exposure to dust-laden return air. [Colinet and Jankowski 1996; Goodman and Listak 1999].
- Scrubber exhaust should be discharged on the return side of the entry and directed toward the return curtain or tubing [Colinet and Jankowski 1996]. If necessary, the CM can be equipped with a crossover duct to carry the exhaust to the opposite side of the miner.
- The end of the exhaust curtain or tubing when not using a scrubber must be kept within 10 ft of the face or an alternative distance if approved by MSHA in the ventilation plan [30 CFR 75.330]. The setback distance must be capable of providing ventilating air that effectively controls methane and respirable dust levels.

## Blowing Face Ventilation

When blowing ventilation is used, intake air is delivered to the face by discharging it from behind line curtain as shown in Figure 4.5 or through tubing. The clean air is blown toward the face and sweeps dust-laden air into the return entry, which is the widest portion of the working entry. This system allows the CM operator to reduce dust exposure by being positioned in the intake air at the inby end of the blowing curtain or tubing [Goodman and Listak 1999; Schultz et al. 2010]. However, this limits the operator's movement to this location. Otherwise, the operator will be located in the main part of the entry, which is in return air and likely increasing dust exposure. If curtain is used, good communication with haulage car operators is essential because the CM operator may not be clearly visible behind the line curtain. As previously mentioned, the CM operator must be aware of the loading boom and remain a safe distance away from the boom as shown in Figure 4.5, right. If the curtain setback cannot be extended far enough away from the CM boom for the operator to safely operate, the operator may have to reposition to the left side of the entry. Unfortunately, this is in return air and may increase dust exposure during this portion of the cut.

For an equivalent face air quantity, blowing ventilation will result in a higher intake air velocity being discharged from behind the line curtain or tubing, when compared to the mean entry air velocity seen with exhaust ventilation. This higher airstream velocity allows for deeper penetration into the face area by the intake air, providing improved mixing and dilution of methane. However, intake air quantity must be equal to or above the measured scrubber airflow provided to the face to prevent recirculation of dust-laden face air, which could result in increased dust exposure for the CM operator [Schultz et al. 2010]. Face airflow measurements must be taken with the scrubber off to obtain accurate intake air readings.

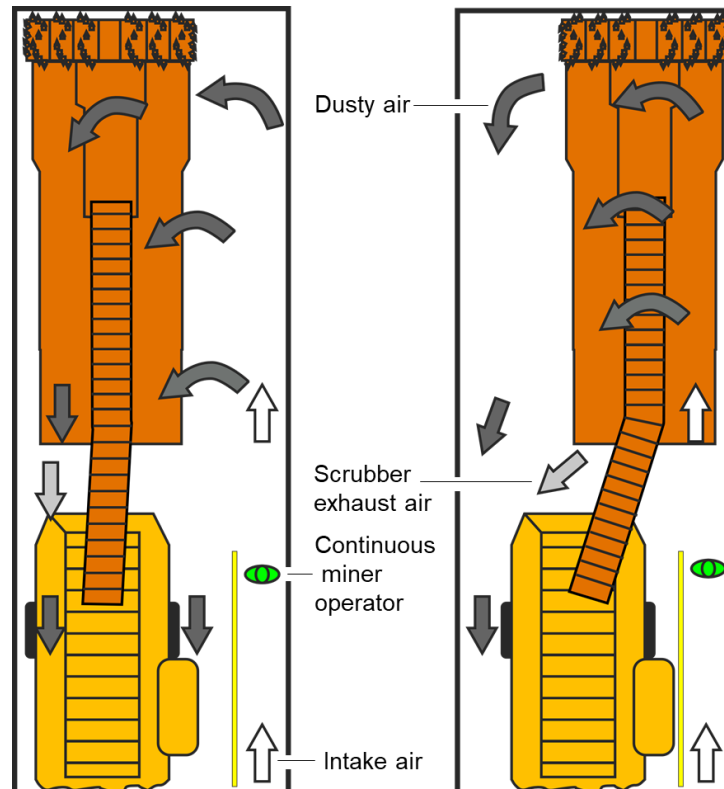

**Figure 4.5. Schematic of blowing face ventilation system showing desired operator positioning for cuts taken on the left (left) and right (right) side of the entry.**

Unfortunately, from a dust control perspective, blowing ventilation positions shuttle car operators in return air, resulting in elevated dust exposures when compared to shuttle car operators working in exhaust ventilation. NIOSH research has shown that shuttle car operator exposures when loading at the CM with blowing ventilation were on average  $0.85 \text{ mg/m}^3$  higher than those observed with exhaust ventilation [Beck et al. 2016] and nearly  $2.0 \text{ mg/m}^3$  higher at some mines [NIOSH 2011].

The following best practices can be used to reduce dust exposure on blowing ventilation sections:

- The CM operator should not routinely be positioned on the return side of the ventilation curtain or tubing during active mining. If the operator is routinely on the return side near the curtain or tubing, a portion of the intake air can be bled over the operator to provide a fresh

airstream. As long as methane remains controlled, the line brattice can be partially opened or a diffuser section of tubing can be installed to bleed fresh air to the operator.

- Using shuttle cars with the cabs located on the intake side of the entry can lead to lower exposures than for cars with the cab on the off-curtain side [Schultz and Fields 1999].
- When it is necessary for the operator to move from the optimum clean air position, the operator should allow the dust-laden air to clear the entry and stop the scrubber (if present) before moving across the entry.
- When aligning the CM to square a face, the operator should position the machine without cleaning/cutting and then return to the end of the curtain before cleaning/cutting resumes. This reduces the potential for dust exposure.
- Scrubber discharge must be on the opposite side of the entry from the intake line brattice or tubing to allow scrubber exhaust to be discharged directly into return air and not interfere with the intake airstream. The scrubber discharge airflow should not liberate dust by being directed at or blowing over a dry mine floor. If dust is being entrained, the mine floor can be sprayed to increase moisture content.
- When using a scrubber, MSHA has historically recommended that the air quantity provided to the face should be equal to the measured air capacity of the scrubber with an upper limit of 20% or 1,000 cfm over the scrubber capacity [Schultz et al. 2010]. More recent controlled laboratory testing has shown that a face airflow of 5,000 cfm above the scrubber airflow resulted in reduced dust levels at the shuttle car and return sampling locations without increasing CM operator dust levels [Klima et al. 2019].
- When using a scrubber, it can continue to be operated for 10–20 seconds after all cutting/loading has been completed to capture any remaining airborne dust in the face. This can prevent or minimize this dust from rolling back into the entry.

## Crosscut Breakthroughs

Extracting crosscuts is a necessary part of the mining cycle but presents challenges from a dust control perspective. When initiating a crosscut, the severe angle of the CM and positioning of the haulage car behind the miner for loading can result in the miner operator needing to reposition from the desired location from a dust control perspective. Also, it may be difficult to initially establish face ventilation that prevents dust from rolling back toward the operator. To illustrate, a summary of NIOSH research in continuous mining operations showed that the respirable dust exposure for the CM operator was nearly  $1.0 \text{ mg/m}^3$  higher in crosscuts when compared to cuts in the headings [Beck et al. 2016].

When completing the crosscut and breaking through into the adjoining entry, the direction of extracting the crosscut can have a substantial impact on the dust exposure of the CM and shuttle car operators. If the breakthrough occurs into the section ventilation as shown in Figure 4.6, left, the intake air short-circuits and carries dust directly toward the equipment operators, increasing their exposure (Figure 4.6, right). If the crosscut breakthrough occurs with the section ventilation, dust-laden air is quickly carried away from the face personnel. Respirable dust concentration in crosscuts breaking into the face ventilation were over  $0.6 \text{ mg/m}^3$  higher [Beck et al. 2016].

For the above reasons, all crosscut breakthroughs should be made with the section ventilation. When not possible, the last portion of the box cut that would result in a breakthrough should not be fully completed, but a small portion of coal can be left in the box cut side. The CM should



then be repositioned into the slab cut, and the slab cut should be completed with a breakthrough at the end of the cut. The short portion of the box cut can then be removed to complete the full breakthrough. This reduces the time that the desired face ventilation pattern is disrupted, thus lowering the operator's dust exposure.

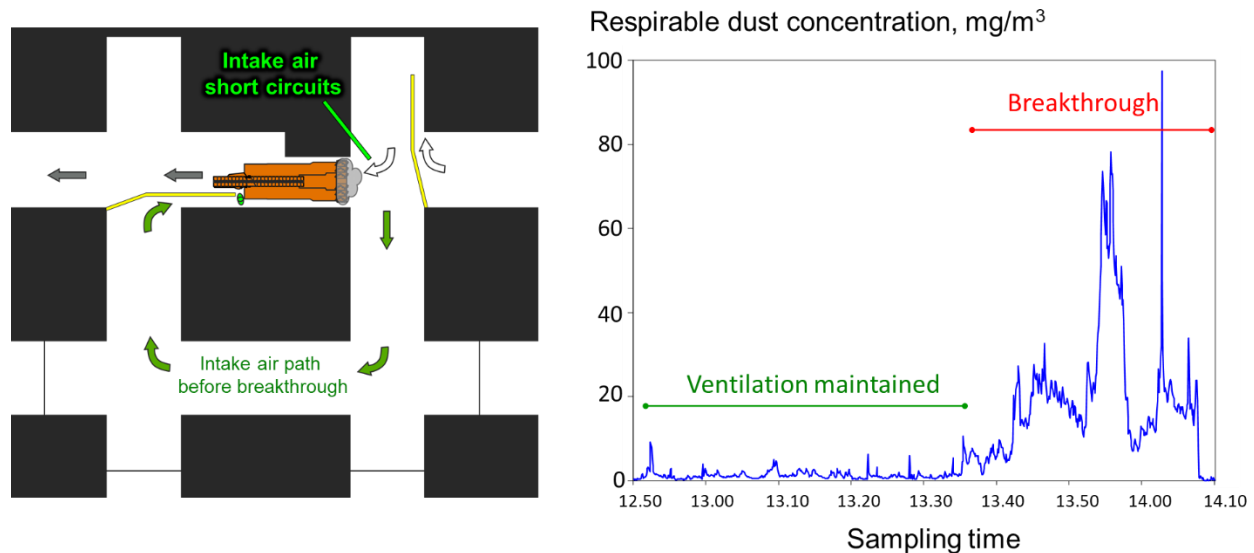

**Figure 4.6. Illustration and line graph demonstrating how crosscut breakthrough into ventilating air short-circuits intake air (left) and results in increased CM operator dust levels (right).**

## Continuous Miner Dust Control

Cutting by the CM represents the greatest source of dust generation on CM sections. Not only is the dust generation a concern for the CM operator, but dust generated by the CM can expose workers downwind of the miner. Therefore, controls should be implemented to reduce dust generation by the CM to as low an amount as possible. The following discussion represents methods for achieving this goal.

### Efficient Cutting

If the minimum quantity of respirable dust is generated during mining operations, then a lesser quantity of respirable dust must be controlled through other technologies. To minimize the amount of respirable dust generated, efficient cutting by the CM should be a primary goal.

### Cutting Bits

Cutting bit selection can greatly affect respirable dust concentrations generated during cutting. A study showed that CM bits designed with large carbide inserts and smooth transitions between the carbide and steel shank as shown in Figure 4.7, left, typically produce less dust [Organiscak et al. 1996]. Lab studies from this research showed that significantly worn conical bits without their carbide tips consume more energy and produce more dust, with higher fractions of respirable dust. After the carbide tip is worn off, the steel body wears even faster. Figure 4.7, right, shows a severely worn bit that NIOSH researchers found during a dust survey. Obviously, this bit was grinding against the cutting surface for some time and should have been replaced as soon as the carbide insert was worn down. Routine inspection of bits with the

replacement of dull, broken, or missing bits improves cutting efficiency and helps to minimize dust generation.

Past research has also shown that increased bit penetration leads to reduced respirable dust generation [Roepke 1984]. Bit sharpness, bit spacing, cutting drum revolutions per minute (rpm), and CM advance rate all impact bit penetration and can be modified to optimize penetration and reduce dust generation.

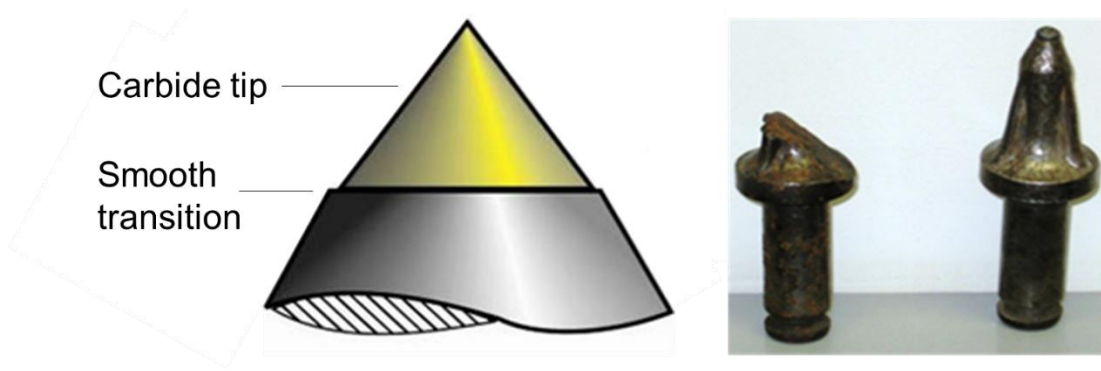

**Figure 4.7. Illustration showing proper bit design (left), which can lower dust generation. Photo comparing a severely worn and new bit (right).**

#### *Modified Cutting Method*

If roof rock must be cut (typically for equipment clearance), it can be beneficial to cut the coal beneath the rock for several feet and then back the CM up to cut the remaining rock, as illustrated in Figure 4.8. This cutting method leaves the rock in place until it can be break out to a free, unconfined space, which creates less respirable dust [USBM 1985]. If the rock contains quartz, this method will also reduce the amount of quartz dust generated.

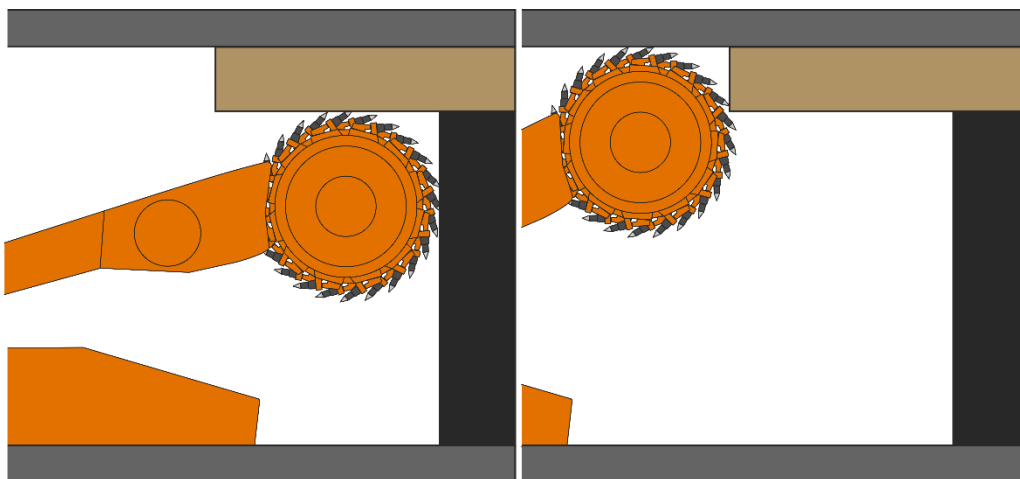

**Figure 4.8. Illustration of how respirable dust generation is reduced by under-cutting roof rock (left) and then backing up to extract rock (right).**

## Water Sprays

Most CMs operate with water sprays located at multiple locations on the machine in order to achieve the desired dust control. These spray locations can include the cutting boom, the loading pan, the sides of the miner (side and blocking sprays), the conveyor throat, and in the cutting drum. As noted in Chapter 3, water sprays can suppress dust by wetting, redirecting dust, or removing dust from the air. The purpose of using sprays at each of these locations is discussed below, while Figure 4.9 illustrates these spray locations.

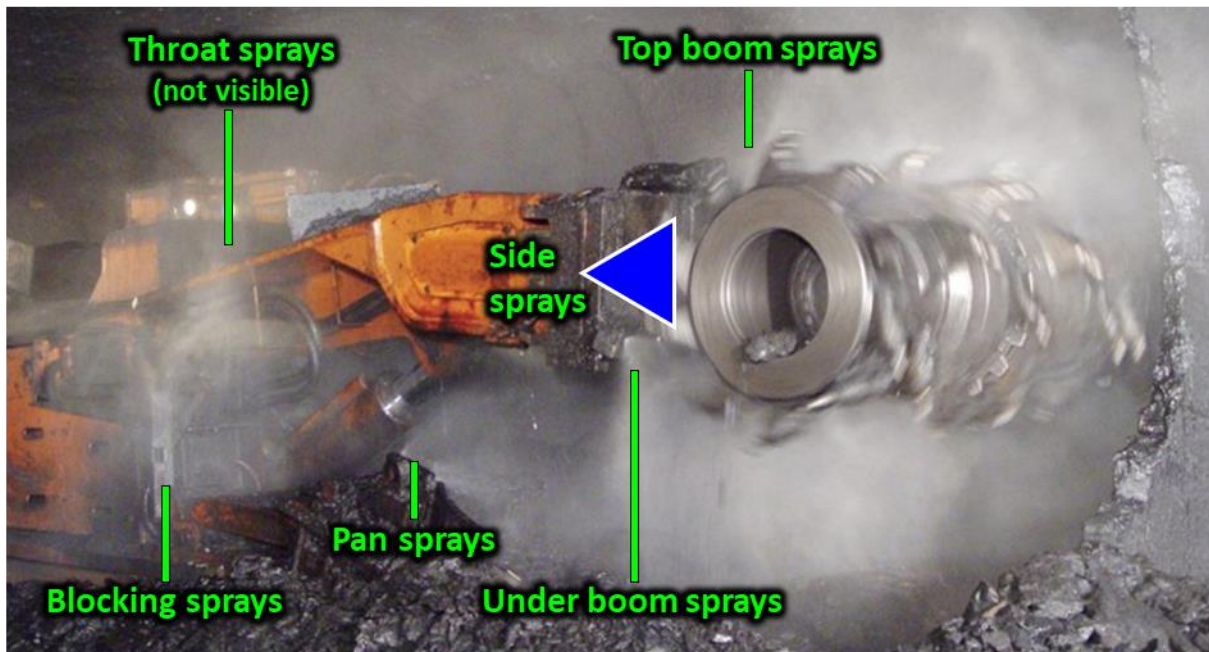

Photo by Business Media MAGS

**Figure 4.9. Common spray locations on continuous miners. Blue triangle indicates location and operational direction of side sprays (which were not present in the original photo).**

## Cutting Boom Sprays

For dust control, the sprays on top of the cutting boom are typically oriented directly at the bits on top of the cutting drum. These sprays provide bit lubrication, cooling, and dust control by wetting coal as it is being cut. A directional spray system can also be used on CMs with sprays mounted across the top of the cutting boom and will be discussed later in this chapter. It is common to mount a number of spray manifolds across the top of the boom directly behind the cutting drum to provide spray coverage and uniform wetting across the entire drum. One concern with the use of these sprays is that if the spray location or operating pressure is incorrect, the sprays can increase dust liberation by forcing dust to roll back into the mining entry. Therefore, it is recommended that the sprays are located as close to the cutting head as possible and operated at less than 100 pounds per square inch (psi) to minimize rollback. Early research indicated that flat fan sprays with horizontal spray patterns were the recommended spray type to direct water to the cutting bits while minimizing rollback by limiting water droplet impact with the mine roof [Jayaraman et al. 1984]. More recent research conducted with a flooded-bed scrubber operating in exhaust ventilation indicated that hollow cone sprays can be effectively operated on the top of

the cutting boom and that an operating pressure of 80 psi was more beneficial than 160 psi [Organiscak and Beck 2010].

Early research on spray types and locations for use on continuous miners identified the dust reduction benefit of locating sprays under the cutting boom [USBM 1976]. Under-boom sprays can provide two functions. They can be directed at the bottom of the cutting drum, as shown in Figure 4.9, to provide wetting of the cut coal as it is discharged from the bottom of the drum. Similar nozzles as mentioned for the top of the cutting boom can be used under the boom at an operating pressure of 60 psi or less, so as not to force dust-laden air out from under the boom. Sprays can also be mounted under the boom and be directed at the gathering arms and loading pan to provide wetting of the broken material as it is gathered and pulled into the conveyor. For these sprays, water quantity delivery for wetting is the goal, and larger orifice sprays at low operating pressures are the most appropriate choice.

Flat fan sprays can be mounted with a vertical spray pattern on the sides of the cutting boom in the position represented by the blue triangle added to the photo in Figure 4.9. These sprays are angled slightly out from the sides of the machine and help confine generated dust near the cutting head while wetting the bits on the ends of the drums. Importantly, these sprays should not be angled so greatly that the spray patterns impact the rib and cause rollback.

### *Gathering Pan Sprays*

Sprays can be mounted on the sides of the gathering pan and directed toward the front center of the gathering pan to provide additional wetting of the cut material as it is being loaded. For this purpose, full cone nozzles should be used at an operating pressure of 60 psi or less. However, sprays located on the gathering pan can also be used to induce air movement toward the return side of the entry. This is particularly important for CMs that are operating without a flooded-bed scrubber, where the face airflow is primarily responsible for controlling respirable dust. In this case, a spray manifold should be mounted on the intake side of the CM and oriented toward the return side of the entry. Hollow cone sprays operated at 175 psi were shown to reduce respirable dust levels at the operator location [USBM 1989].

### *Conveyor Throat Sprays*

Sprays should be located in the conveyor throat of the CM to wet the mined product as it travels up the conveyor for loading into the shuttle car [USBM 1985]. The goal of adding moisture at this location is to minimize dust liberation as the coal discharges from the loading boom of the CM and lands in the shuttle car. If the coal is not sufficiently wet, dust will be liberated along the length of the CM conveyor and at the shuttle car. Both of these dust sources are closer to the miner operator than dust being generated at the face. In addition, added moisture retained in the mined product will help reduce dust liberation when the shuttle car unloads at the feeder-breaker. Therefore, full cone sprays with larger orifices and operating at low pressures are an appropriate choice.

### *Blocking Sprays*

Spray manifolds mounted on the sides of CMs outby the flooded-bed scrubber inlets have been shown to improve dust control when used with blowing face ventilation. In a NIOSH study [Goodman 2000], flat fan sprays mounted with vertical spray patterns were mounted roughly 2 ft outby the scrubber inlets. The sprays were oriented approximately 30 degrees out from the

machine body toward the rib and operated at 50 psi. Test results in a full-scale dust gallery and then at a mining operation indicated that dust levels at the rear of the CM were lower. It appeared that the blocking sprays assisted in keeping the dust generated by the cutting head in the face area longer, allowing for greater capture by the flooded-bed scrubber.

### *Wet Head Sprays*

As noted in Chapter 3, water sprays on longwall shearer cutting drums are located in front of or behind the cutting bits to suppress dust at the point of cutting. Sprays located behind the bit were also shown to reduce the likelihood of frictional ignitions. Over 30 years ago, several attempts to implement sprays on the cutting heads of CMs failed due to the lack of dependable water seals for the design of the cutting head on the CM. More recently, improved water seals have been developed that resulted in water sprays being placed behind the cutting bits on CMs, as shown in Figure 4.10, for improved frictional ignition control and potentially improved dust control.

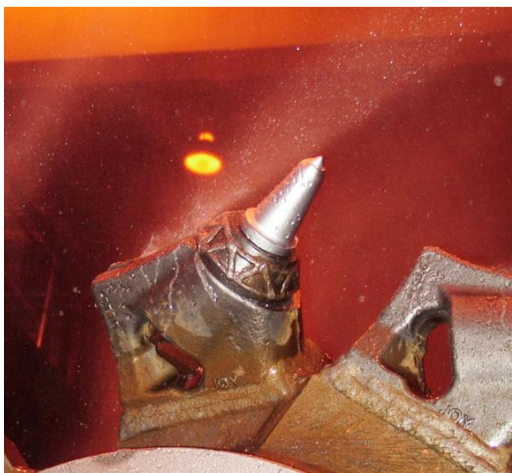

Photo by Joy Global Underground Mining

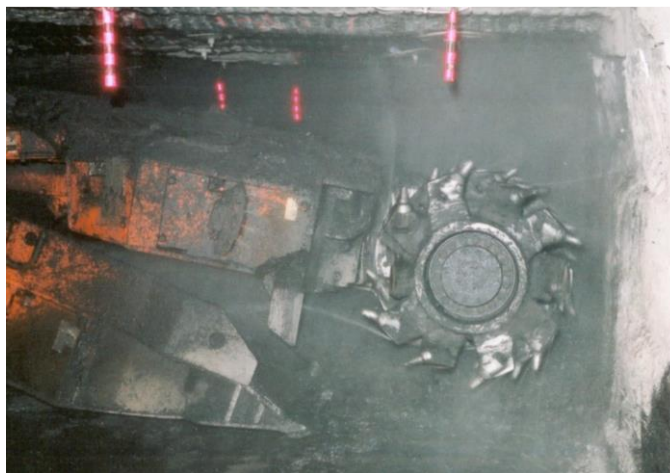
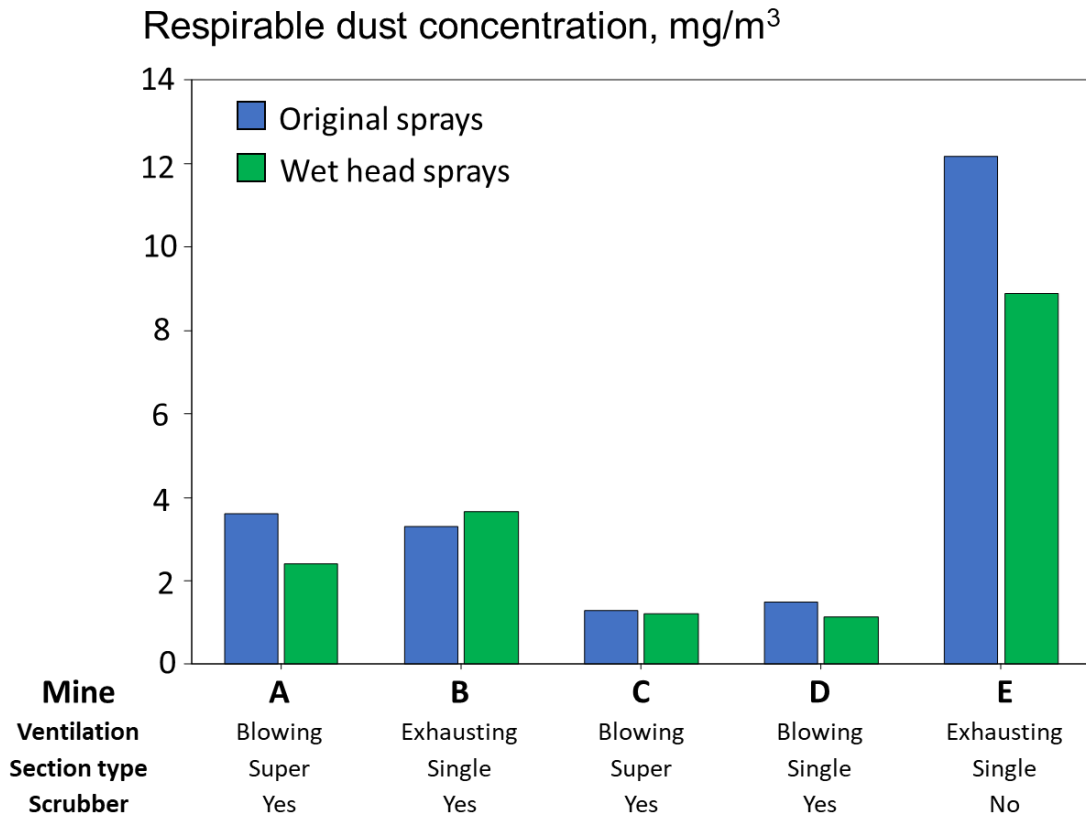

Photo by NIOSH

**Figure 4.10. Wet head spray located behind cutting bit (left) and system operating on a continuous miner underground.**

NIOSH conducted surveys at five mines to evaluate the dust control potential of the wet head spray system when compared to the existing external spray system being used by each mine (labeled “Original sprays” in Figure 4.11) prior to the time of installing the wet head [Listak et al. 2010]. Key operating conditions at these mines and results for return dust levels measured during these surveys are provided in Figure 4.11. At Mines A and E, reductions of 33% and 27%, respectively, were found in return dust levels when the wet head spray system was operated. At the other three mines, minimal reductions or increases in return dust levels were found with the wet head sprays operating. Consequently, operation of the wet head sprays system did not produce consistent dust control performance across these mines.



**Figure 4.11. Comparing return dust concentrations with wet head spray systems to original spray systems used at five mines, with key operating conditions listed for each mine.**

Another observation from these surveys shows that at the four mines where the CMs were equipped with flooded-bed scrubbers, operation of the scrubbers appeared to be the dominant dust control technology. Respirable dust levels in the returns at all four mines using a scrubber were substantially lower than at the mine without a scrubber, regardless of the spray system being used.

### *Spray Fan Directional Sprays*

As discussed in Chapter 3, water sprays can be used to direct airflow, and a successful directional spray system has routinely been used on longwall shearers to reduce the dust exposure of shearer operators. A directional spray system for a CM (also known as the spray fan system) was developed for use with exhaust face ventilation and no scrubber to help prevent the buildup of methane gas at the face. This system places sprays in a defined pattern on the CM [USBM 1983a] to assist in moving air up the intake side of the entry, sweeping air across the face, and directing air toward the return curtain or tubing. Hollow cone sprays are used in this system to take advantage of their air moving capability. Since the goal of this system is to move air, water pressures of 150 psi or greater are more effective. Initial testing indicated that up to 70% of the intake air could reach within 1 ft of the face when using the spray fan system [Kissell et al. 1979].

This spray system is designed to promote turbulence, mixing, and dilution of methane by the intake air. However, from a dust control perspective, turbulence created by high-pressure sprays

can result in dust rollback toward the CM operator. NIOSH laboratory testing evaluated the spray fan system while simulating a deep cut face at two operating pressures (70 and 190 psi), two face airflow quantities, and two curtain setback distances [Goodman and Pollock 2004]. Results showed higher CM operator dust levels at the higher operating pressure for all test conditions. At shuttle car operator positions and in the return, the higher operating pressure resulted in increases or decreases in dust levels depending upon the other combinations of parameters being tested. As a result, the spray fan system should be viewed with caution and evaluated at the specific mine conditions when dust control is the primary goal.

### Flooded-Bed Scrubbers

Flooded-bed scrubbers are fan-powered dust collectors installed on CMs to capture dust-laden air at the cutting face. This air is drawn into inlets mounted close to the cutting head and through steel ductwork toward the back of the CM, where a multi-layer mesh filter panel is being wetted by a water spray or sprays. As the dust particles and water droplets impact the filter mesh and work their way through the layers, the dust particles become encapsulated in the water droplets. After exiting the filter panel, these dust-laden water droplets encounter a wave-blade mist eliminator which causes the airstream to make numerous turns through the unit. The momentum of the dust-laden water droplets causes them to strike the mist eliminator blades and be removed from the airstream. The relatively clean, dry air is then discharged by the fan back into the mine atmosphere. Figure 4.12 illustrates the components and layout of a common flooded-bed scrubber design.

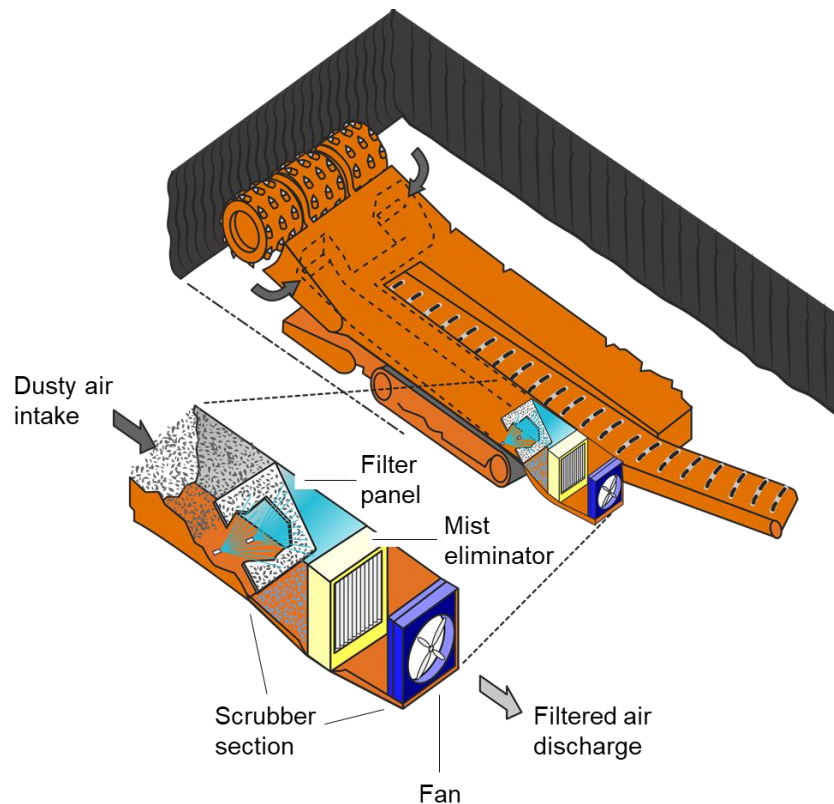

**Figure 4.12. Components and layout of a flooded-bed scrubber.**

The initial flooded-bed scrubber design was patented in 1983 [Campbell et al. 1983] but not extensively adopted by the mining industry. However, the development of radio remote control for CMs led to the potential for extracting extended cuts greater than 20 ft in depth. With remote control, the CM operator can remain under supported roof while the CM advances up to 40 ft in cut depth. Extended cuts reduce the number of face changes required by the CM, which can lead to higher production and potentially fewer injuries that occur during CM moves. Therefore, most U.S. continuous mining operations prefer to take extended cuts when mining conditions permit.

The use of extended cuts must be approved by MSHA after assessing the competence of the roof and the mine's ability to control methane and respirable dust to regulated levels. Operation of the scrubber aids in increasing the quantity of ventilating air reaching the face for methane control and also removes a large percentage of respirable dust. Consequently, the flooded-bed scrubber is a key component in receiving extended cut approval from MSHA for many mining operations. This has led to widespread use of scrubbers, and it is estimated that over 90% of CMs now in use in the United States are equipped with scrubbers [Defibaugh 2018].

### *Dust Control Effectiveness*

The overall dust reduction achieved with flooded-bed scrubbers is determined by the capture efficiency and collection efficiency [Colinet and Jankowski 2000]. The capture efficiency is the quantity of face ventilation air that is drawn into or "captured" by the scrubber. This is determined from the air-moving capacity of the scrubber and the quantity of ventilating air supplied to the face. For example, if the scrubber has a capacity of 7,500 cfm and 8,000 cfm of air is supplied to the face, the scrubber will ideally capture nearly 94% of the ventilating air. As a result, increasing the air-moving capacity of flooded-bed scrubbers can be beneficial. Maximum scrubber airflow capacity has increased to 20,000 cfm [Defibaugh 2020].

The collection efficiency represents the percentage of respirable dust entering the scrubber that is removed by the scrubber before the air is discharged back into the mine atmosphere. For example, if the dust concentration of the air entering the scrubber is 10 mg/m<sup>3</sup> and the concentration of the air discharged by the scrubber is 1 mg/m<sup>3</sup>, the collection efficiency would be 90%.

Research has been conducted to evaluate the respirable dust collection efficiency of flooded-bed scrubbers while implementing supplemental controls within the scrubber, using different filter media, and using different filter densities [USBM 1990b; Colinet and Jankowski 2000]. The supplemental controls (adding surfactant or oil emulsion to the scrubber spray water or adding atomizing or fogging sprays as preconditioning sprays upwind of the normal sprays) resulted in minimal improvement in dust collection and, as a result, were never adopted. Different filter materials (bottle brush and synthetic materials) showed potential dust collection benefits but their use has waned (bottle brush) or was never implemented on a production basis (synthetic material) after initial underground testing [McClelland et al. 1991].

At the initiation of the USBM-cited research effort, the standard filter panel being used in scrubbers contained 40 layers of stainless steel mesh in a flat-panel design. Figure 4.13, left, shows this panel along with an 18-inch ruler for scale and a sample of the stainless steel filter material removed from a panel. As expected, laboratory testing indicated that the denser the filter the higher the collection efficiency, with 30-, 40-, and 80-layer flat panels removing 93%, 96%, and 99% of respirable dust, respectively [USBM 1990b]. Unfortunately, as the filter density



increases, the pressure drop across the filter also increases, resulting in reduced scrubber airflow [Colinet and Jankowski 2000]. At approximately 5,000 cfm scrubber airflow, the pressure drop for the 30-, 40-, and 80-layer filters was 2.7, 4.1, and 8.0 inches of water column (in. wc), respectively. If the pressure drop increase is severe enough, fan stall can occur.

For particles above 5 micrometers ( $\mu\text{m}$ ) in aerodynamic size as collected with impactors during the USBM tests, the collection efficiency for the different filters and test conditions were between 97.5% and 99.7%. However, as the particle size decreased below 5  $\mu\text{m}$ , the collection efficiency decreased for all filters and test conditions. In addition, the difference in collection efficiency between the filters and other test conditions became greater, with collection efficiencies ranging from 72% to 95% for 1.1–2.1  $\mu\text{m}$  particles.

Filter clogging from particles pulled into the scrubber also increases pressure drop and reduces airflow through the scrubber as a cut progresses. In order to create greater filter surface area, pleated filters have become the standard design currently being used. Pleated filters containing 30, 20, and 10 layers of stainless steel mesh were readily available at one time and used in mines. Figure 4.13, center and right, shows 10- and 30-layer pleated filter panels, respectively, that are being backlit. The greater amount of light visually passing through the 10-layer filter panel illustrates the substantial difference in density for these two filters.



Photos by NIOSH

**Figure 4.13. Forty-layer flat filter panel with mesh material shown (left). Ten-layer (center) and 30-layer (right) pleated panels with backlighting to show relative difference in filter density.**

The respirable dust collection efficiency and measured scrubber airflow for 30-, 20-, and 10-layer filters are shown in Figure 4.14 [Colinet and Jankowski 2000]. In this testing, a variable speed fan was adjusted so that approximately 7,900 cfm was flowing through the scrubber with the 20-layer filter installed. Without adjusting the fan, the 30- and 10-layer filters were then inserted and the airflow was measured. The inverse relationship between respirable dust collection efficiency and scrubber airflow for changes in filter density is clearly shown in this graph. The dust collection efficiency dropped from 93% for the 30-layer filter to 74% for the 10-layer filter, but airflow increased from 6,900 cfm for the 30-layer filter to over 8,200 cfm with the 10-layer filter. The leading CM scrubber manufacturer indicates that it no longer supplies 10-layer filters and only supplies 20- or 30-layer filter panels [Defibaugh 2021].

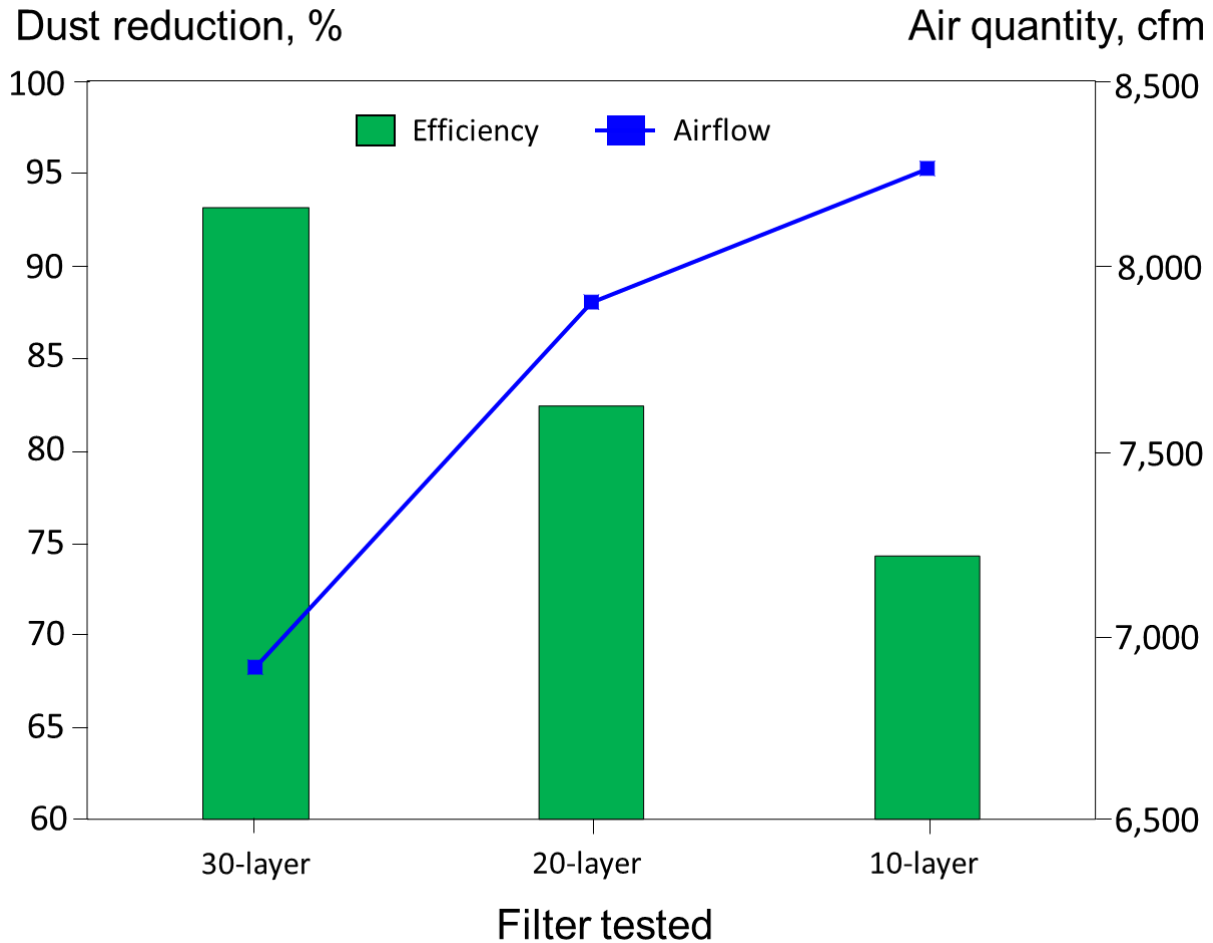

**Figure 4.14. Respirable dust reduction and scrubber airflow with different-density filters.**

Optimum flooded-bed scrubber performance would be achieved if all of the dust-laden air at the cutting face is drawn into the scrubber and a high percentage (> 90%) of the respirable dust is removed from this air [NIOSH 1997]. Full-scale laboratory and mine-site testing have shown that operation of the scrubber can reduce dust levels in the return by 80% to 90% [Colinet and Jankowski 1996; NIOSH 2013]. Therefore, it is very important to monitor and maintain scrubber airflow at maximum levels.

### *Scrubber Airflow Measurement*

Full pitot tube traverses must be conducted periodically by the mine operator (frequency may be included in the ventilation plan) to quantify the airflow through the scrubber. MSHA requires that approximately 16 data points but not less than 14 be collected to determine the average scrubber velocity [MSHA 2020b]. Measurement ports are created by drilling holes in the scrubber ductwork that are equally spaced, while being less than six inches from the ductwork sides and each other. The pitot tube is inserted in each of these ports and a minimum of four velocity pressure readings are taken from each port at pre-determined depths within the scrubber ductwork. The velocity pressure readings are converted to velocity readings and then averaged to obtain the average air velocity within the scrubber. This average velocity is

multiplied by the internal area of the scrubber to obtain the scrubber airflow volume. A detailed discussion of determining scrubber airflow with a full pitot tube traverse is available on the MSHA website [MSHA 2020c].

MSHA inspectors are required to conduct a full pitot tube traverse on each scrubber during each respirable dust survey [MSHA 2020b]. If the measured air volume does not meet the minimum quantity stated in the ventilation plan, scrubber maintenance must be completed to achieve the minimum quantity before mining can begin as specified in 30 CFR Part 75.362(a)2.

The inspector can use the full traverse data to establish a centerline correlation measurement, which can be used during non-measurement inspections of the scrubber system to determine if the scrubber is being maintained. The mine operator can also submit a centerline correlation in the ventilation plan for MSHA approval. If approved, the mine operator can use the centerline correlation on a cut-to-cut basis instead of a full traverse to determine if the scrubber airflow is suitable. Ideally, a centerline hole is available to obtain the centerline velocity measurement. However, if there are an even number of ports, centerline velocity readings from the two center ports are averaged to determine the centerline velocity. A correlation factor is then calculated by dividing the full traverse average air velocity by the centerline velocity. The correlation factor is then used in the equation below to calculate the scrubber volumetric airflow.

$$\text{Scrubber airflow (cfm)} = \text{centerline velocity (fpm)} \times \text{correlation factor} \times \text{scrubber area (ft}^2\text{)}$$

### *Scrubber Maintenance*

Scrubbers have been shown to be one of the most effective respirable dust controls available to mine operators. Consequently, maintaining performance of the scrubber is a critical component of controlling respirable dust levels. However, it should be noted that scrubber exhaust air can contain dust levels that approach or exceed the current respirable dust standard, as shown for mines A-D in Figure 4.11.

Scrubbers can lose as much as one-third of their airflow after just one cut [Schultz and Fields 1999; NIOSH 2011; NIOSH 2013], so maintenance requirements are defined in the ventilation plan. The most common cause of airflow loss is filter panel clogging, which requires the filter panel to be removed for cleaning or replacement. Water is used to wash down the filter panel to remove particles that are lodged in the filter mesh as shown in Figure 4.15, left. Some mines have multiple filter panels and simply swap one panel for another after a cut has been completed. This can provide time for panels to dry between use, which may allow additional material to be removed by tapping the filter panel.

The scrubber inlets, ductwork, mist eliminator (demister), and sump also need to be inspected and cleaned on a periodic basis. Larger pieces of coal and rock may be pulled into the scrubber inlets and ductwork before settling out of the airstream. Material can become trapped in the mist eliminator and buildup can occur in the sump. A water hose can be used to clean these components, with Figure 4.15, right, showing a mist eliminator being washed down.



Photos by NIOSH

**Figure 4.15. Cleaning scrubber filter panel (left) and mist eliminator (right) with a water spray.**

It is also very important that the spray nozzles in the ductwork be checked to ensure they are not plugged and are wetting the entire filter panel. If the filter panel is not completely wetted by the sprays, respirable dust may pass through the screen to be discharged back into the ambient air. Alternatively, particles may build up on the screen, increasing pressure drop and lowering airflow through the scrubber. Full cone nozzles are often used to provide complete wetting of the filter.

The specific conditions at each mine (e.g., cut depth, mining height, quantity of rock cut) will dictate the frequency of maintenance needed to ensure the scrubber is removing as much respirable dust as possible.

### *Redirected Scrubber Discharge*

When air is recirculated at the face, MSHA has concerns over the potential for methane to build up to unsafe levels. However, a few sections with low methane emissions were granted approval by MSHA to redirect all or a portion of the scrubber exhaust toward the mining face. The redirected airflow could help compensate for low mean entry air velocity, with the goal of reducing dust rollback from the face. NIOSH completed limited testing of scrubber redirection at two mines [Organiscak and Beck 2013]. Several locations in the face area were sampled for respirable dust and mixed results were observed, with some dust levels increasing and others decreasing.

NIOSH also conducted controlled laboratory tests to evaluate the effect of redirecting scrubber exhaust air to the face. One test condition had the exhaust air split with equal portions directed up each side of the CM, while the second test condition had 15% of the scrubber discharge directed up the off-curtain side of the CM [Organiscak and Beck 2013]. From a dust control viewpoint, less than desired results were found when redirecting the scrubber exhaust toward the face.

## Wetting Agents

Coal is hydrophobic and it is not uncommon to see coal dust floating on top of puddled water in underground mines, similar to that shown in the left beaker in Figure 4.16, left. The goal of adding a wetting agent to spray water is to reduce the surface tension of the water to promote improved wetting of the coal as shown in the right beaker in Figure 4.16, left, and more effective airborne dust capture. Through the years, multiple wetting agent tests have been performed in coal mining with mixed results. Some studies have shown negligible dust control improvements [Chander et al. 1991; Tessum and Raynor 2017]; others have shown improved dust capture around 25% [Kost et al. 1980]; and others have shown a 40% improvement at one mine but inconclusive results at a second mine [USBM 1996]. In addition, multiple laboratory techniques (e.g., zeta potential, capillary rise, coal dust sink tests) have been attempted to better match a wetting agent to an individual coal seam, with inconsistent success [Kost et al. 1980; USBM 1983b]. A general finding across these studies and others is that increasing the wetting agent concentration improved wetting, at least up to a certain point [Tien and Kim 1997].

More recently, NIOSH conducted testing in an enclosed dust chamber to evaluate the impact on airborne respirable coal dust capture when adding three different wetting agents to the spray water [Organiscak 2013] at two operating pressures. As shown in Figure 4.16, right, the addition of the different wetting agents resulted in less than 2% improvement in airborne dust capture. This graph shows that slightly larger improvements were obtained by simply increasing the water pressure. However, these tests did not evaluate the potential dust reduction that may result from improved wetting of the mined product by the wetting agents.



Photo by NIOSH

**Figure 4.16. Hydrophobic coal floating on water and sinking with the addition of a wetting agent (left) and a bar chart representing changes in airborne dust capture with wetting agents (right).**

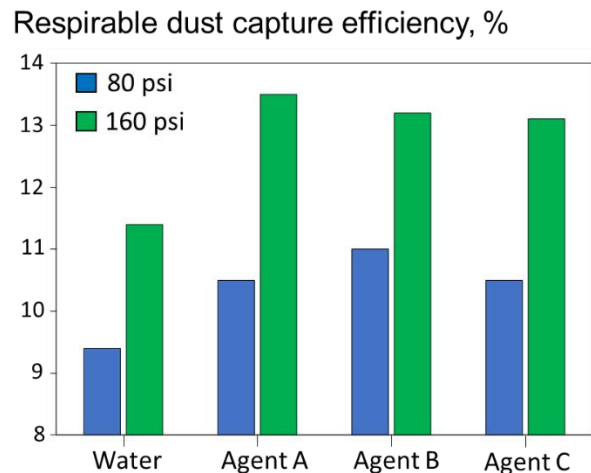

The addition of a wetting agent exhibits some potential for improving respirable dust control, but studies have shown that the greatest potential results from matching a specific agent with a specific coal. Another factor influencing performance is the properties of the individual mine water, including pH levels [Feldstein 1981]. Unfortunately, laboratory tests have not been consistently reliable predictors to identify the most promising wetting agent for a given coal.

As mentioned for foam application in Chapter 3, the potential effects on miner’s health and impact on coal cleaning operations must be considered before using chemical additives.

## Roof Bolter Dust Control

As noted at the beginning of this chapter, RB operator occupations have had the highest quartz exposure on CM sections and have multiple sources of dust exposure. From the RB, drilling into the roof rock can obviously be a significant source of quartz exposure, as can be emptying the dust collector box. Also, dust captured by the drill collector but not removed from the airstream can be discharged back into the ambient mine air. In addition to sources at the RB, working downwind of the CM can lead to elevated quartz exposure, particularly if the CM is not using a flooded-bed scrubber. A number of technologies and practices have been developed to reduce dust exposures from these sources and each are discussed below.

### Efficient Drilling and Dust Confinement

As previously indicated, a primary goal of reducing respirable dust exposure should be to minimize the amount of respirable dust being generated by any dust-producing activity. If the dust is not generated, it does not have to be managed with other control technologies. For roof bolters, this means efficient drilling with sharp bits and drilling parameters adjusted for the type of rock being drilled into.

In the United States, most underground coal mines use roof bolters with dry dust collectors and tungsten carbide-tipped drill bits. As shown in Figure 4.17, left and right, sharp carbide cutting inserts are mounted on top of a steel bit body, with the carbide designed to cut into the roof rock during drilling. As the carbide loses its sharp cutting edge (Figure 4.17, left center), drilling penetration will be reduced, leading to greater dust generation as the bit grinds rather than efficiently cuts into the rock. Consequently, sharp drill bits should always be used to minimize dust generation and maintain penetration rate.

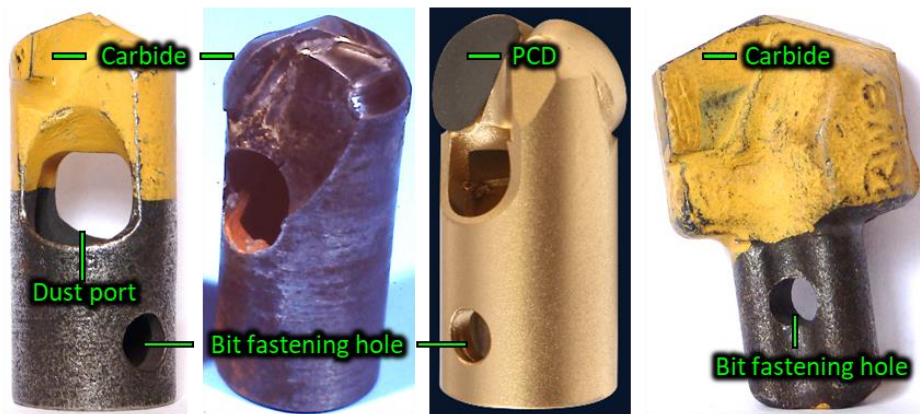

Photo by Kennametal

Photo by BCR National Laboratory

Photo by U.S. Synthetic

Photo by Kennametal

**Figure 4.17. New (left) and worn (left center) tungsten carbide dust hog style bits, polycrystalline diamond (PCD) dust hog bit (right center), and shank-style bit (right).**

The most commonly used RB drill bits are “dust hog” style bits, which have dust collection ports in the bit body as shown with the three bits on the left in Figure 4.17. The dust capture ports in dust hog style bits are adjacent to the cutting inserts when compared to a shank-type bit as shown

in Figure 4.17, right, which requires the dust capture port to be located in the drill steel. The location of the dust port is particularly important as drilling is initiated. Studies have shown that the greatest respirable dust generation occurs when drilling the first few inches of a hole as the drill bit initiates drilling into the roof rock but before being confined within the hole [Colinet et al. 1985]. With the dust collection ports in the bit body, more effective dust capture begins earlier during the dustiest part of drilling. This finding led to respirable dust reductions of 75% to 91% with one-inch-diameter dust hog bits when compared to shank bits under similar operating conditions during the first 12 inches of drilling [Colinet et al. 1985]. Underground testing of numerous dust hog and shank bits also indicated that dust hog bits drilled 25% faster in hard roof [Divers et al. 1986].

An alternative to carbide-tipped bits are drill bits with polycrystalline diamond (PCD) cutting inserts. When tested with wet drilling, these bits demonstrated an ability to substantially extend bit life with less wear when compared to shank-style carbide tipped bits [USBM 1992b]. However, this testing indicated that specific operating parameters (rpm, thrust, and water pressure) needed to be maintained to prevent the brittle PCD bits from fracturing. PCD bits are available for dry drilling applications as shown in Figure 4.17, center right. Limited testing for dust generation when comparing the PCD bit design to dust hog bits resulted in inconsistent sampling conditions and mixed results [Seiter et al. 2015].

As mentioned, there is no confinement at the drill bit when drilling first begins, and dust can easily be liberated into the ambient air. A bit sleeve can be used to help confine dust during this initial portion of drilling and reduce dust levels [Beck 2015]. The bit sleeve system contains a 3.5-inch-long metal cylinder, a metal clip, and large washer as shown in Figure 4.18, left. The washer, clip, and bit sleeve are placed on the drill steel as shown in Figure 4.18, center. The washer is then used to push the bit sleeve up to the roof before the start of drilling with the metal clip holding the bit sleeve in place as shown in Figure 4.18, right. With the bit sleeve providing dust confinement during the first few inches of drilling, respirable dust levels were reduced by 57% during the first 12 inches of drilling into concrete during laboratory testing [Beck 2015].

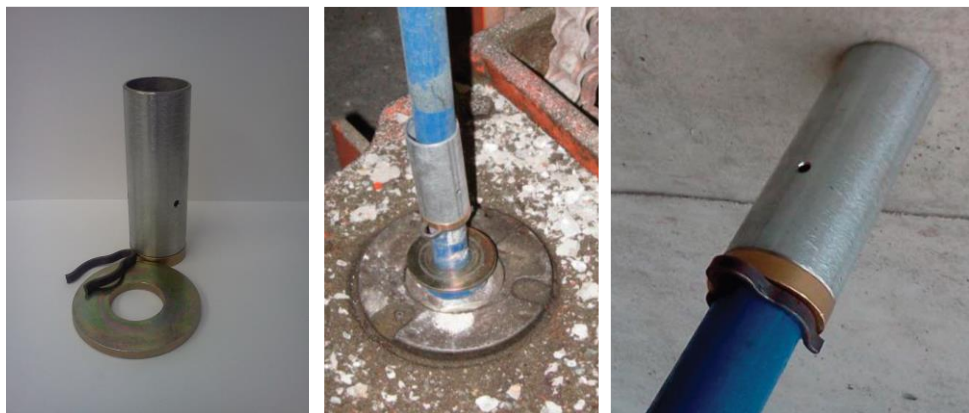

Photos by NIOSH

**Figure 4.18. Components of drill bit sleeve (left), installed on a drill steel (center), and bit sleeve raised to roof (right).**

In addition to cutting with sharp bits, the drill feed rate, bit rotation speed, and torque may be adjusted to maximize efficient cutting [Cotton et al. 2015]. Some of the reported benefits of optimizing these drilling parameters included increased bit life, reduced clogging of the

vacuum system and dust blowout from the drill hole, reduced hanging of drill steels in holes, reduced noise, and increased particle size of drill cuttings, which reduces fine dust generation. Slowing bit rotation with a similar thrust allows each rotation of the bit to take a deeper bite into the roof rock, creating greater penetration and less respirable dust [Jiang et al. 2018]. A computer-controlled drilling system that uses real-time feedback on drilling parameters is available but has not gained widespread use [Burgess 2020].

### Dry Vacuum Dust Collector

Dry vacuum dust collection systems have historically been used on roof bolters in U.S. underground coal mines. These systems are designed to pull dust generated by drilling through a hollow drill steel and rubber hoses back to a pre-cleaner and collector box. The pre-cleaner is a cyclone designed to remove larger particles from the airstream to reduce dust loading of the collector box. The collector box has multiple chambers and contains a cyclone and final canister filter, which are used to remove the captured dust from the airstream. The filtered air is then discharged through a muffler back into the ambient mine air. Figure 4.19 illustrates the various components of the dry vacuum system. Past research has shown that when this system is operating properly it can be very effective in controlling dust generated by drilling [Beck and Goodman 2008].

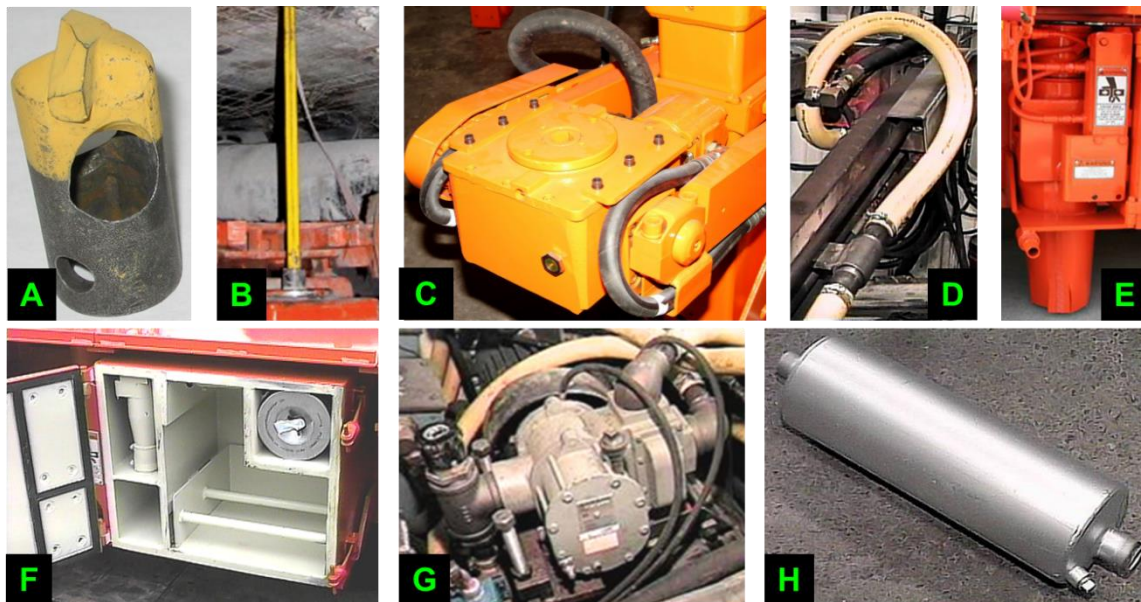

Photos A-B by NIOSH

Photos C-H by J.H. Fletcher & Co.

**Figure 4.19. Components of a dry vacuum dust collection system. Dust-laden air is drawn through the bit (A), drill steel (B), drill head (C), hoses (D) to the pre-cleaner (E), and to the dust box (F) by the blower (G) before filtered air is discharged through the muffler (H) back into the mine air.**

A vacuum gauge should be placed in the drill chuck to periodically measure the vacuum being generated at the drill head as shown in Figure 4.20, left. The minimum required blower vacuum is specified on the dust certification plate mounted on the bolting machine and in the mine's ventilation plan. This minimum vacuum must be maintained to achieve the desired airflow through the system. If the minimum is not achieved, the collector box should be cleaned, the



collector box gaskets (Figure 4.20, center) should be inspected for integrity, and checks should be made throughout the system for loose or damaged hoses. Smoke tubes can be used to help identify leaks in the system as shown in Figure 4.20, right.



**Figure 4.20. Methods to ensure dust collector performance. A gauge is placed in the drill chuck to measure vacuum at the drill head (left), gaskets (in black) on the door of dust collector box are checked (center), and smoke tubes can be used to check for leaks in the system (right).**

### *Cleaning the Dust Box*

Frequent cleaning of the dust collector box is necessary to ensure proper operation of the dust collection system. When opening the dust box, collected dust can spill out onto the mine floor, as shown in Figure 4.21, left. Historically, the roof bolter operator would then clean dust out of the box by using a wooden wedge or other type of rake to scoop dust out by hand (Figure 4.21, center) or by pulling an insert out of the box (Figure 4.21, right.)



**Figure 4.21. Dust dropping out of dust box (left), operator cleaning dust box by hand (center), and insert used to assist in cleaning of dust box (right).**

These actions can create a dust cloud in the breathing zone of the operator and contaminate his or her clothing. Although this cleaning task typically only lasts a few minutes, research has shown that airborne respirable dust levels between 6 and 14 mg/m<sup>3</sup> can be present [Goodman and Organiscak 2002]. Also, after work clothes become contaminated, past studies [Butterworth and Donoghue 1970; USBM 1986] have shown that movement by the worker can result in dust being released from the clothes back into the air. A more recent study examined dust release from clothing contaminated with a mixture of monodisperse silica particles of 3, 5, and 10  $\mu\text{m}$

[McDonagh and Byrne 2014]. Results indicated that the resuspended fraction from contaminated clothing was approximately 30% on average, with up to 67% of the deposited dust being released during high physical activity. A NIOSH study monitored the dust exposure of two workers simultaneously performing the same job task in a confined area [Cecala et al. 2017]. Both workers were wearing hooded sweatshirts, with one sweatshirt being visibly dusty. Instantaneous dust sampling results showed the average dust levels over a defined work period were  $73.6 \mu\text{g}/\text{m}^3$  for the worker with the dusty sweatshirt compared to  $26.5 \mu\text{g}/\text{m}^3$  for the second worker.

Not surprising, analysis of collector box dust has also shown that elevated silica content can be found in this dust with an average of 26% silica in one study [Joy et al. 2010] and approximately 45% in another study [USBM 1990a]. Therefore, it is important to use proper cleaning procedures to minimize initial operator dust exposure and to avoid contamination of clothing to prevent resuspension of dust throughout the work shift.

Ideally, cleaning should take place in a well-ventilated entry with the RB operator positioned on the upwind side of the collector so that the liberated dust cloud is quickly removed from the operator's breathing zone. If a rake is used to pull dust from the main compartment, an extended handle should be used so that dust does not contaminate the operator's clothing. When emptying dust boxes on a dual-boom roof bolter, the return-side operator should empty the collector box first and then take a position on the intake side of the entry until the intake-side box is emptied. For additional protection, a respirator can be worn during the cleaning procedure.

### *Dust Collector Bags*

The dry dust collector box can be fitted with a bag similar to a vacuum cleaner bag (Figure 4.22, left) that captures dust in the main compartment of the collector. Use of the collector bag confines dust to reduce dust exposures when cleaning the dust box and speeds up the cleaning effort. This system is a retrofit option for most existing RBs and can also be supplied with new bolters. This system uses a nozzle (Figure 4.22, center), which is installed in the center compartment of the collector. The bag is attached to this nozzle to capture dust (Figure 4.22, right) before it reaches the filter cartridge. Use of the collector bag also prevents dust from being deposited into the roadway and potentially entrained into the ventilating air. It is recommended that a pre-cleaner cyclone be used to reduce loading of the bag with larger material.

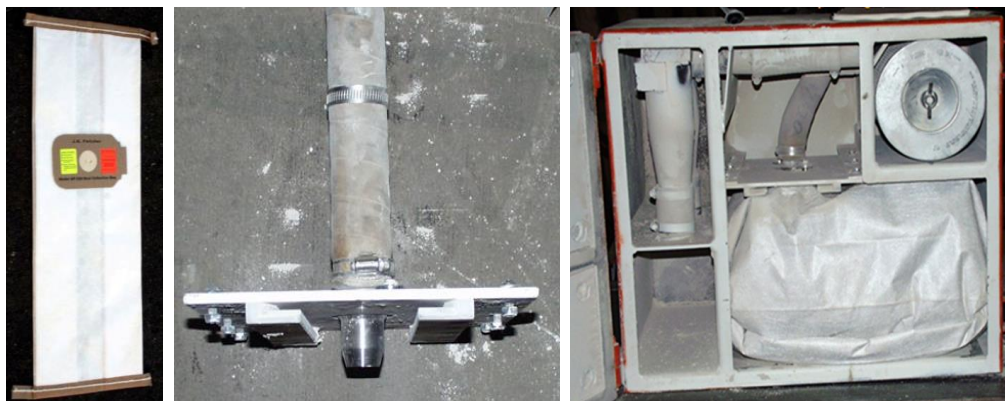

Photos by NIOSH

**Figure 4.22. Dust collector bag (left), bag nozzle (center), and bag positioned in collector box and filled with dust (right).**

When using collector bags in laboratory testing, dust loading and pressure drop on the canister filter were substantially reduced, indicating the canister filter would need to be changed less frequently [Listak and Beck 2008]. As part of this research, testing of the collector bags was completed at one mine and indicated that the collector bag reduced dust emissions in the bolter exhaust by approximately 85%. Collector box cleaning time was reduced from 4 minutes to 30 seconds.

### *Final Canister Filter*

In past practice, canister filters were removed and struck against a surface such as the bolter tire to dislodge caked dust from the filter media. The filter was then reinserted into the collector box. Unfortunately, this practice can create a dust cloud that contaminates the breathing zone and the clothes of the RB operators. Cleaning the filter in this manner also creates the potential for contaminating the collector's downstream discharge components (vacuum pump and muffler) with respirable dust. If improperly installed, dust can leak past the filter cartridge. When the downstream components become contaminated, respirable dust is discharged back into the mine environment in the collector's exhaust [USBM 1990a]. To rectify this hazardous condition, the downstream components must be removed and cleaned as described in the next section. NIOSH, MSHA, and RB manufacturers recommend that contaminated filters be removed and replaced with new filters to minimize worker dust exposures. Replacement of filter canisters should be completed in well-ventilated entries.

### *Cleaning the Discharge Side of the Collector*

If the discharge side of the collector system becomes contaminated due to collector filter damage and/or leaks, all components downstream of the collector box must be removed and flushed with water. Surveys have shown that removing and cleaning contaminated components downstream of the canister filter results in major improvements in dust and silica levels emitted from the collector's discharge [Thaxton 1984].

### *Pre-cleaner Dust*

The pre-cleaner is a cyclone designed to remove larger particles from the dust collector airstream prior to this dust entering the collector box. The pre-cleaner automatically dumps collected dust at regular intervals or is triggered by an action of the RB, such as raising the stab jack. The goal is to reduce dust loading in the collector box.

Some concern was expressed by mine operators regarding potential dust exposure for the RB operators resulting from the pre-cleaner discharging dust onto the mine floor. MSHA analysis of the dust from the pre-cleaner indicated that less than 2% of the dust was in the respirable size range [Fletcher 2000]. NIOSH conducted an evaluation of the dust dumped by the pre-cleaner and monitored dust levels at the pre-cleaner and RB operator locations [Joy et al. 2010]. Results of 46 samples collected from four MSHA districts indicated that the pre-cleaner dust contained respirable-sized dust (5%–35%) but less than the dust in the collector box (13%–87%), indicating that the cyclone was removing mainly larger particles as designed. Respirable dust sampling results from three mining sections did not reveal noticeable increases in airborne respirable dust concentrations at the pre-cleaner or operator positions when the pre-cleaner emptied dust onto the mine floor. Brattice or rubber can be installed as a skirt on the pre-cleaner dump to help contain the dust as it falls to the mine floor.

## Wet and Mist Drilling

For wet drilling, water is pumped to the drilling interface through the drill steel, captures dust, and then flows out of the drill hole. Successful dust control with wet drilling typically requires that approximately 2 gallons per minute (gpm) of water be supplied to the drill hole, with larger quantities required for acceptable drilling rates in harder roof rock [Divers et al. 1986]. Although wet drilling can effectively control dust emissions, this option can create difficult working conditions for RB operators and lead to problematic water accumulation on the mine floor.

Mist drilling reduces water usage when compared to wet drilling while attempting to maintain effective respirable dust control. Reduced quantities of water along with compressed air are supplied to the drilling interface through ports in the drill bit in an effort to capture dust. Mist drilling typically uses less than 0.5 gpm. Although more desirable from an operations perspective, mist drilling was not as effective in controlling airborne respirable dust when compared to properly operating dry vacuum systems in laboratory and mine testing [Beck and Goodman 2008].

## Working Downwind of the Continuous Miner

As shown in Figure 4.11 and reported in other NIOSH research [Goodman et al. 2006; NIOSH 2013; Organiscak et al. 2016], working downwind of the CM can result in exposure to elevated respirable dust levels, particularly if the CM is not operating a flooded-bed scrubber. Regardless of the type of face ventilation being used, the CM cutting sequence should be designed to eliminate or limit the amount of time the RB operators work downwind of the CM. The number of cuts that can be bolted downwind is specified in the MSHA-approved ventilation plan and is typically limited to a maximum of one cut per shift for most operations.

If the RB must work downwind of the CM, a cut sequence should be developed that maximizes the distance between the CM and RB faces. Increasing this distance will allow for greater mixing and dilution of the dust generated by the CM before it reaches the bolting face [Organiscak et al. 2016]. Also, the RB operators should move out of the return air of the CM immediately after completing bolting in the face. NIOSH has observed RB operators remaining in return air while waiting for the CM to complete a cut, which adds to their dust exposure.

A dry dust collector has been developed for use when bolter operators are working downwind of the CM. This technology is discussed in the Emerging Control Technologies for Continuous Mining Sections section at the end of this chapter. Also, canopy air curtain technology provides protection from respirable dust for RB operators and is discussed next.

## Canopy Air Curtain

The canopy air curtain is an engineering control that can be used to provide protection from dust generated during drilling and dust generated by the CM when the RB is located downwind of the CM. A centrifugal fan draws ambient air from the mining entry through a filter and blows this air down over the RB operator through a plenum mounted on the underside of the canopy as illustrated in Figure 4.23. The plenum is ideally the same shape as the RB canopy and is equipped with internal baffles and a series of holes in the bottom plate to distribute the filtered air across the entire plenum. Therefore, protection is provided to the operator while positioned under any portion of the canopy.

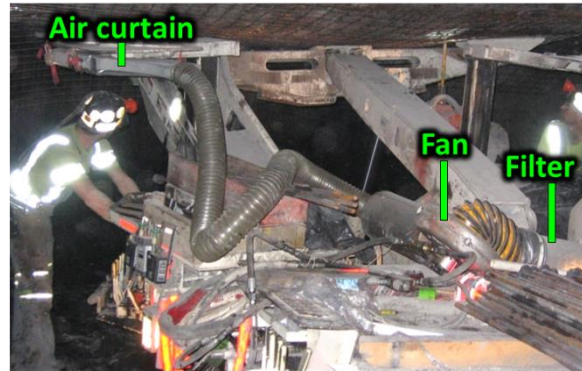
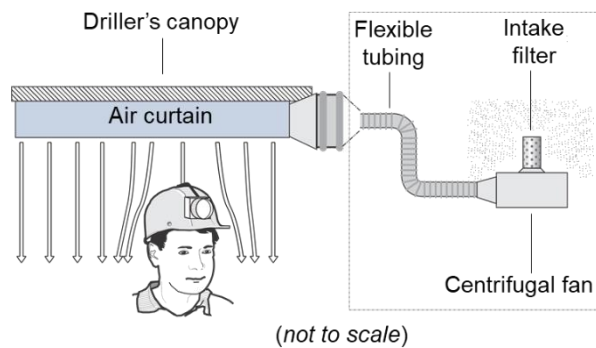

Photo by NIOSH

**Figure 4.23. Schematic illustrating canopy air curtain components and operating principle (left) and being tested at an underground mine (right).**

Laboratory testing with 350 cfm provided to the canopy air curtain resulted in respirable dust reductions up to 75% at mean entry air velocities from 60 to 120 fpm [Listak and Beck 2012]. The dust reductions were calculated by comparing dust levels outside of the canopy air curtain to levels measured 10 inches below the canopy. Initial mine tests were shortened due to a damaged fan but resulted in respirable dust reductions of 35% to 53% for the two faces that were bolted. The canopy air curtain underwent several design modifications, including designs developed by an RB manufacturer, before NIOSH conducted additional tests at a coal mine. During three shifts of testing, the RB was never downwind of the CM. Therefore, dust levels below  $0.5 \text{ mg/m}^3$  were observed for all cuts sampled and below  $0.1 \text{ mg/m}^3$  for many of the cuts bolted. As a result, varied results were obtained with such low dust levels, but maximum dust reductions up to 60% were observed [Reed et al. 2019].

The canopy air curtain technology has been adopted by J.H. Fletcher & Co. and incorporated into the canopy designs for the company's roof bolting machines as shown in Figure 4.24. Canopy air curtains can be installed as retrofits or incorporated into new machines.



Photos by NIOSH

**Figure 4.24. Canopy air curtains installed on roof bolters at two underground coal mines.**

## Shuttle Car Dust Control for Blowing Face Ventilation

As previously discussed, shuttle car operators are positioned in return air when blowing face ventilation is used and are at risk for elevated dust exposure. Several operational items can be implemented to lower the dust exposure for these operators:

- Shuttle car operator cabs should be located on the side of entry where the intake air is delivered to the face by line curtain or tubing. MSHA sampled dust levels on each side of entry and found lower concentrations ranging from 33% to 90% on the intake side. [Schultz and Fields 1999].
- Shuttle car operator cabs should not be located in the direct discharge air of the dust scrubber on the continuous miner.
- The shuttle car routes between the CM and feeder should be configured to minimize the amount of time the shuttle cars spend in return air.

NIOSH recently completed laboratory testing in a full-scale CM dust gallery to evaluate the impact on shuttle car operator dust levels of changing several engineering controls. Blowing face ventilation of 8,000 and 12,000 cfm was evaluated, while the CM scrubber was operated at 7,000 cfm. Combinations of face air quantities, curtain setback distances of 30 and 50 feet, and with/without blocking sprays operating on the sides of the CM were tested. Shuttle car operator dust levels were lowered for face airflow of 12,000 cfm with a 50-foot curtain setback and the blocking sprays operating [Klima et al. 2019].

## Maintenance of Dust Controls

To realize the greatest and ongoing benefit from applied dust controls, maintenance of the controls must be a priority for both management and miners. Mine management must provide the supplies and time to conduct required maintenance, and miners must recognize when controls have been compromised and require maintenance.

As was noted for flooded-bed scrubber airflow, the performance of an effective dust control can be substantially degraded if the proper maintenance is not completed in a timely manner. The need to conduct maintenance on dust control technologies cannot be overemphasized as a key factor for minimizing dust exposures.

## Emerging Control Technologies for Continuous Mining Sections

### Self-cleaning Nozzles

One concern with the use of underboom sprays on CMs is the need to safely perform maintenance on clogged sprays. The cutting boom must be supported for personnel to safely access the sprays, which may result in less frequent maintenance. A potential solution is the development of a self-cleaning spray nozzle manufactured by Repair King. NIOSH conducted laboratory tests to compare the water flow rate, airflow induction, and airborne respirable dust capture efficiency of two differently sized hollow cone Repair King nozzles with two similarly sized hollow cone nozzles, each from Spraying Systems Co. and Steinen-Hahn, whose sprays are commonly used in underground coal mines [Klima et al. 2017]. Results of this testing showed the self-cleaning sprays had similar water flow rates and airflow induction as the other two nozzles, but airborne dust capture was approximately 25% less. Therefore, these sprays appear to

be equivalent to the other sprays for wetting applications but not airborne dust capture. NIOSH conducted lab tests to evaluate general performance of these nozzles. The self-cleaning potential of the Repair King sprays needs to be assessed in operating mines for reduced clogging potential.

## Dry Scrubber

As noted previously, a potentially large source of dust exposure for RB operators is working downwind of the CM. To address this issue, NIOSH issued a research contract to J.H. Fletcher & Co. to develop a stand-alone, mobile dry scrubber (DS) dust collector that could be positioned to clean the return air from the CM and provide filtered air to the RB operators. Figure 4.25, left, shows how the DS could be positioned to provide filtered air to the RB operators.

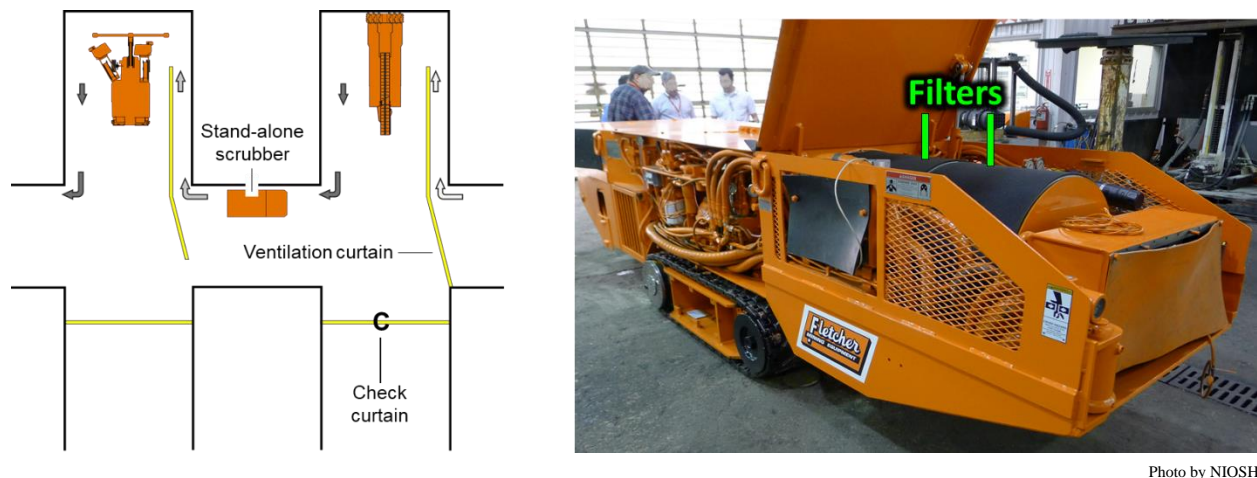

Photo by NIOSH

**Figure 4.25. Positioning of dry scrubber to provide filtered air to roof bolter operators (left) and dry scrubber with cover raised to show filters (right).**

The DS prototype shown in Figure 4.25, right, is a 4-ft-wide by 4-ft-high by 16-ft-long crawler-driven unit equipped with a 30-hp vane axial fan and variable frequency drive (VFD) controller.

The VFD is designed to automatically adjust the fan to maintain the user-specified air quantity as dust buildup occurs on the filters. The fan is capable of pulling between 3,000 and 9,000 cfm through the scrubber. The unit contains two 28-inch outer diameter cylindrical filters that are rated at 99% efficiency for 2- $\mu$ m sized particles. The discharge from the scrubber can be fitted with a removable steel duct to turn the discharge air 90 degrees. A remote-control module is used to tram the unit.

NIOSH initially conducted laboratory testing to evaluate the performance characteristics of the DS. In the controlled laboratory tests, the DS averaged over 95% respirable dust removal efficiency at both the low and high airflows [Organiscak et al. 2016]. After the eighth hour of dust testing at an airflow setting of 8,500 cfm, the pressure differential across the filters increased so that the DS airflow started to drop (8,420 cfm) below the setpoint as the fan reached its maximum adjustment.

Underground testing was conducted on two super sections that were using blowing face ventilation with line curtain. The DS was positioned in the last open crosscut to clean the return air from the CM and blow filtered air into the face with the 90-degree duct attached. Respirable

dust sampling conducted upwind of the DS and at the face showed a 50% reduction in respirable dust with the DS operating between 2,700 to 4,900 cfm [Organiscak et al. 2016].

Approval for use in underground coal mines was obtained from MSHA, and the DS is commercially available.

### Wet Collector Box

As noted previously, dry vacuum dust collection systems are traditionally used on RBs in the United States. When properly operating, dry collectors have been shown to be effective for controlling dust at the drill hole. However, the dust box must be cleaned periodically and is a potential source of dust exposure, which can contain elevated levels of quartz.

An alternative that modifies the dry collection box has been evaluated with the mine receiving permission from MSHA to modify its dry collector for testing. A vacuum is still created at the drill hole to pull dust-laden air back to the collector box. However, the box has been modified by removing the internal cyclone, the lower section of the metal compartment divider, and adding a water spray, drain valve, and angled plates in the bottom panel of the collector box as shown in Figure 4.26, left. The water spray nozzle was operated at a flow rate of 0.5 to 2.0 gpm at 100 psi to wet the dust as it entered the collector box. Water was supplied to the RB through a hose connected to the water line for the CM. A water-resistant canister filter has been developed by the RB manufacturer and was used in this testing. After bolting each cut, the RB operator would activate a hydraulically controlled drain valve at the bottom of the collector box to drain the saturated dust, which is shown in Figure 4.26, right. Remaining material can be rinsed out with a water hose tapped into the water feed to the RB. Since the dust is saturated, little or no dust should become airborne during this cleaning.



Photos by NIOSH

**Figure 4.26. Wet collector box on roof bolter (left) and wetted material in collector box (right).**

Sampling was conducted by NIOSH at an underground mine to compare dust levels from a wet collector box to the standard dry collector box [Reed et al. 2021a]. A vest was equipped with gravimetric samplers and worn by the RB operators only during dust box cleaning to isolate dust exposure during this activity. Personal dust monitor (PDM) samplers were worn by the RB operators throughout their bolting shift to measure overall dust exposure while on the section. Sampling results showed that the use of the wet collector box reduced operator dust levels during



box cleanout by an average of 80% over three sampling shifts, while overall shift dust reductions from the PDM samples averaged over 25%. Also, the use of the wet collector box reduced the quartz content in the gravimetric samples collected during box cleanout from an average of 7.4% with the dry collector to below detectable levels with the wet box.

J.H. Fletcher & Co. has submitted this wet box design to MSHA seeking approval for use in underground coal mines.

### Shuttle Car Canopy Air Curtain

The canopy air curtain has demonstrated the ability to lower the dust exposure of RB operators. In an effort to lower the dust exposure of haulage car operators, particularly when blowing face ventilation is used, NIOSH wanted to adapt the canopy air curtain for use on haulage cars. NIOSH issued a contract to Marshall University with J.H. Fletcher & Co. as a subcontractor to design, fabricate, and install a canopy air curtain on a haulage car in an underground coal mine. NIOSH conducted laboratory testing of this air curtain design and then in-mine testing with it installed on the canopy of a ram car (battery hauler) as shown in Figure 4.27, left.



Photos by NIOSH

**Figure 4.27. Canopy air curtain installed on underside of ram car canopy (left) and showing how filtered air is blown down over operator's position, along with a dust sampling package located outside of cab (right). White arrows indicate airflow.**

A sampling package containing two gravimetric pumps/filters and a personal DataRAM (pDR) instantaneous sampler was located just outby the operator's compartment as shown in Figure 4.27, right. While in the cab, the operator wore a pDR unit. In addition, a PDM unit was placed on the floor of the operator's cab with the PDM sampling inlet clipped to the operator's lapel. The gravimetric-based samplers at each location were used to determine calibration factors for the pDR during each sampling shift. The pDR was set to record a respirable dust reading every two seconds, which would typically generate 20 to 30 sampling points, while the ram car was being loaded behind the miner, which was the primary dust source. Sampling results were also analyzed for when the ram car was tramming to and from the feeder-breaker and during unloading at the feeder-breaker [Reed et al. 2021b].

With the canopy air curtain providing over 300 cfm of airflow, sampling results indicate that an average dust reduction of 65% was observed for the ram car operator when loading behind the

CM. While tramming to the feeder-breaker, unloading, and tramming back to the CM, average dust reductions of 18%, 36%, and 24% were measured, respectively. Dust reductions were lower while tramming as the air discharged from the canopy air curtain had to compete with the entry air velocity combined with the air velocity created by the ram car tramming. These results indicate that a canopy air curtain installed on haulage vehicles can successfully reduce operator dust exposures.

## References for Chapter 4

- 79 Fed. Reg. 24814 [2014]. Mine Safety and Health Administration: Lowering miners' exposure to respirable coal mine dust, including continuous personal dust monitors; final rule. To be codified at 30 CFR Parts 70, 71, 72, 75, and 90.
- Ainsworth SM, Gero AJ, Parobeck PS, Tomb TF [1995]. Quartz exposure levels in the underground and surface coal mining industry. *Am Ind Hyg Assoc J* 56(10):1002–1007.
- Beck TW, Goodman GVR [2008]. Evaluation of dust exposures associated with mist drilling technology for roof bolters. *Min Eng* 60(12):35–39.
- Beck TW [2015]. Evaluations of bit sleeve and twisted-body bit designs for controlling roof bolter dust. *Min Eng* 67(2):34–40.
- Beck TW, Organiscak JA, Pollock DE, Potts JD, Reed, WR [2016]. Influence of continuous mining arrangements on respirable dust exposures. *Society for Mining, Metallurgy & Exploration, Transactions Vol. 340*, pp. 1–10.
- Burgess T [2020]. E-mail message from Tim Burgess, Executive Vice President of Engineering, J.H. Fletcher & Co. to Jay Colinet, NIOSH, July 7.
- Butterworth R, Donoghue JK [1970]. Contribution of activity released from protective clothing to air contamination measured by personal air samplers. *Health Phys* 18(4):319–323.
- Campbell JAL, Moynihan DJ, Roper WD, Willis EC [1983]. Dust control system and method of operation. U.S. Patent 4,380,353. Washington, DC: U.S. Patent and Trademark Office.
- Cecala AB, Haas EJ, Patts JR, Cole GP, Azman AS, O'Brien AD [2017]. Helmet-CAM: an innovative tool for exposure assessment of respirable dust and other contaminants. In *Proceedings of the 16th North American Mine Ventilation Symposium*, Golden, CO, June 17–22, pp. 13-1 to 13-12.
- CFR. Code of Federal regulations. Washington, DC: U.S. Government Printing Office, Office of the Federal Register.
- Chander S, Alaboyun AR, Aplan FF [1991]. On the mechanism of capture of coal dust particles by sprays. *Proceedings of the 3rd Symposium on Respirable Dust in the Mineral Industries*, Pittsburgh, PA, October 17–19, pp.193–202.
- Colinet JF, Shirey GA, Kost JA [1985]. Control of respirable quartz on continuous mining sections. U.S. Department of the Interior, Bureau of Mines Open File Report 29-86, NTIS No. PB/86-179546.
- Colinet JF, Jankowski RA [1996]. Dust control considerations for deep-cut faces when using exhaust ventilation and a flooded-bed scrubber. *Society for Mining, Metallurgy, and Exploration, Transactions Vol. 302*, pp. 104–111.
- Colinet JF, Jankowski RA [2000]. Silica collection concerns when using flooded-bed scrubbers. *Min Eng* 52(4):49–54.
- Cotton D, Burgess T, Martin T [2015]. Optimizing drilling parameters for improved bolting safety and performance. *34th International Conference on Ground Control in Mining*, Morgantown, WV, July 28–30, pp. 330–336.

- Defibaugh J [2018]. E-mail message from Joe Defibaugh, Engineer—Dust & Ventilation, Komatsu Mining Corp. to Jay Colinet, NIOSH, September 10.
- Defibaugh J [2020]. E-mail message from Joe Defibaugh, PDTC Group Leader, Komatsu Mining Corp. to Jay Colinet, NIOSH, May 18.
- Defibaugh J [2021]. E-mail message from Joe Defibaugh, PDTC Group Leader, Komatsu Mining Corp. to Jay Colinet, NIOSH, January 4.
- Divers EF, Organiscak JA, Hilton T [1986]. Bolt faster, cut bit costs in hard roof. *Coal Age* 91(7):54–55.
- Feldstein N [1981]. Surface chemical technology for improved wetting of coal dust. U.S. Department of the Interior, Bureau of Mines Open File Report 127-81, NTIS No. PB82-104654.
- Fletcher [2000]. Dust collection systems. *Fletcher Product Newsletter*, Huntington, WV, Q1.
- Goodman GVR, Listak JM [1999]. Variation in dust levels with continuous miner position. *Min Eng* 51(2):53–59.
- Goodman GVR [2000]. Using water sprays to improve performance of a flooded-bed dust scrubber. *Appl Occ Env Hyg* 15(7):550–560.
- Goodman GVR, Organiscak JA [2002]. Evaluation of method for controlling silica dust exposures on roof bolters. *Society for Mining, Metallurgy, and Exploration, Transactions* Vol. 312, pp. 133–137.
- Goodman GVR, Pollock DE [2004]. Use of a directional spray system design to control respirable dust and face gas concentrations around a continuous mining machine. *J Occup Env Hyg* 1(12):806–815.
- Goodman GVR, Beck TW, Pollock DE, Colinet JF, Organiscak JA [2006]. Emerging technologies control respirable dust exposures for continuous mining and roof bolting personnel. In: Mutmanský JM, Ramani RV eds. *Proceedings of the 11th U.S./North American Mine Ventilation Symposium*, University Park, PA, June 5–7, pp. 211–216.
- Hall NB, Blackley DJ, Halldin CN, Laney AS [2019]. Continued increase in prevalence of r-type opacities among underground coal miners in the USA. *Occup Env Med* 76(7):479–481.
- Jayaraman NI, Kissell FN, Schroeder W [1984]. Modify spray heads to reduce dust rollback on miners. *Coal Age* 89(6):56–57.
- Jiang H, Luo Y, McQuerrey J [2018]. Experimental study on effects of drilling parameters on respirable dust production during roof bolting operations. *J Occup Env Hyg* 15(2):143–151.
- Joy GJ, Beck TW, Listak JM [2010]. Respirable quartz hazard associated with coal mine roof bolter dust. In: Hardcastle S, McKinnon DL, eds., *Proceedings of the 13th U.S./North American Mine Ventilation Symposium*, Sudbury, Ontario, Canada, June 13–16, pp. 59–64.
- Kissell FN, Schroeder W, Ruggieri S, Hoover S [1979]. Recent experience with the spray fan. *Proceedings of the 2nd International Mine Ventilation Congress*, Reno, NV, Nov 4–8, pp. 115–120.
- Klima S, Seaman C, Mischler S, Organiscak J [2017]. Comparison of different hollow cone water sprays for continuous miner dust control applications. *Society for Mining, Metallurgy, and Exploration Annual Meeting*, Denver, CO, February 19–22, Preprint 17-026.

Klima SS, Organiscak JA, Colinet JF [2019]. Reducing shuttle car operator dust exposure by improving continuous miner blowing face ventilation parameters. Society for Mining, Metallurgy, and Exploration Annual Meeting, Denver, CO, February 25–27, Preprint 19-078.

Kost JA, Shirey GA, Ford CT [1980]. In-mine tests for wetting agent effectiveness. U.S. Department of the Interior, Bureau of Mines Open File Report 30-82, NTIS No. PB82-183344.

Listak JM, Beck TW [2008]. Laboratory and field evaluation of dust collector bags for reducing dust exposure of roof bolter operators. *Min Eng* 60(7):57–63.

Listak JM, Goodman GVR, Beck TW [2010]. Evaluation of the wet head continuous miner to respirable dust. *Min Eng* 62(9):60–64.

Listak JM, Beck TW [2012]. Development of a canopy air curtain to reduce roof bolters' dust exposure. *Min Eng* 64(7):72–79.

McClelland JJ, Colinet JF, Bringhurst B [1991]. Performance evaluation of irrigated filters. Society for Mining, Metallurgy, and Exploration, Transactions Vol. 290, pp. 1828–1831.

McDonagh A, Byrne MA [2014]. The influence of human physical activity and contaminated clothing type on particle resuspension. *J Env Radioactivity* 127:119–126.

MSHA [2020a]. MSHA data sets—16. Quartz samples. U.S. Department of Labor, Mine Safety and Health Administration. <https://arlweb.msha.gov/OpenGovernmentData/OGIMSHA.asp>

MSHA [2020b]. Coal mine health inspection procedures, Handbook number:PH89-V-1 (27). U.S. Department of Labor, Mine Safety and Health Administration.

MSHA [2020c]. How to correctly determine dust scrubber air quantity. U.S. Department of Labor, Mine Safety and Health Administration, Pittsburgh Safety and Health Technology Center, <https://arlweb.msha.gov/S&HINFO/BlackLung/ControlDust2009/7%20Pitot%20Tube%20Measurements.pdf>

NIOSH [1997]. Exposure to silica dust on continuous mining operations using flooded-bed scrubbers. Cincinnati, OH: U.S. Department of Health and Human Services, Centers for Disease Control and Prevention, National Institute for Occupational Safety and Health, DHHS (NIOSH) Publication No. 97-147, Hazard Identification 1.

NIOSH [2011]. Evaluation of face dust concentrations at mines using deep-cutting practices. By Potts JD, Reed WR, Colinet JF. Pittsburgh, PA: U.S. Department of Health and Human Services, Centers for Disease Control and Prevention, National Institute for Occupational Safety and Health, DHHS (NIOSH) Publication No. 2011-131, Report of Investigations 9680.

NIOSH [2013]. Impact on respirable dust levels when operating a flooded-bed scrubber in 20-foot cuts. By Colinet JF, Reed WR, Potts JD. Pittsburgh, PA: U.S. Department of Health and Human Services, Centers for Disease Control and Prevention, National Institute for Occupational Safety and Health, DHHS (NIOSH) Publication No. 2014-105, Report of Investigations 9693.

Ondrey RS, Haney RA, Tomb TF [1995]. Dust control parameters necessary to control dust on longwall and continuous mining operations. Society for Mining, Metallurgy, and Exploration, Preprint 95-145.

Organiscak JA, Khair AW, Ahmed M [1996]. Studies of bit wear and respirable dust generation. Society for Mining, Metallurgy, and Exploration, Transactions Vol. 298, pp. 1874–1879.

- Organiscak JA, Beck TW [2010]. Continuous miner spray considerations for optimizing scrubber performance in exhaust ventilation systems. *Min Eng* 62(10):41–46.
- Organiscak JA [2013]. Examination of water spray airborne coal dust capture with three wetting agents. Society for Mining, Metallurgy, and Exploration, Transactions Vol. 334, pp. 427–434.
- Organiscak JA, Beck TW [2013]. Examination of redirected continuous miner scrubber discharge configurations for exhaust face ventilation systems. Society for Mining, Metallurgy, and Exploration, Transactions Vol. 334, pp. 435–443.
- Organiscak J, Noll J, Yantek D [2016]. Examination of a newly developed mobile dry scrubber (DS) for coal mine dust control applications. Society for Mining, Metallurgy, and Exploration, Transactions Vol. 340, pp. 38–47.
- Pollock DE, Potts JD, Joy GJ [2010]. Investigation into dust exposures and mining practices in mines in the southern Appalachian region. *Min Eng* 62(2):44–49.
- Reed WR, Klima S, Shahan M, Ross GJH, Singh K, Ross G, Grounds T [2019]. A field study of a roof bolter canopy air curtain (2nd generation) for respirable coal mine dust control. *Int J Min Sci Tech* 29(5):711–720.
- Reed WR, Klima S, Mazzella A, Ross G, Roberts G, Deluzio J [2021a]. A second case study of field test results for comparison of roof bolter dry collection system with wet collection system. Society for Mining, Metallurgy, and Exploration Annual Meeting, Denver, CO, March 1–5, Preprint 21-008.
- Reed WR, Colinet JF, Klima SS, Mazzella A, Ross G, Workman M, Morson T, Driscoll J [2021b]. Field test of a canopy air curtain on a Ramcar for dust control in an underground coal mine. Society for Mining, Metallurgy, and Exploration Annual Meeting, Denver, CO, March 1–5, Preprint 21-009.
- Reynolds LE, Blackley DJ, Colinet JF, Potts JD, Storey E, Short C, Carson R, Clark KA, Laney AS, Halldin CN [2018]. Work practices and respiratory health status of Appalachian coal miners with progressive massive fibrosis. *J Occ Env Med* 60(11):575–581.
- Roepke WW [1984]. General methods for primary dust control during coal cutting. *Min Eng* 36(6):636–644.
- Schultz MJ, Fields KG [1999]. Dust control considerations for deep cut mining sections. Society for Mining, Metallurgy, and Exploration Annual Meeting, Denver, CO, March 1–3, Preprint 99-163.
- Schultz MJ, Tomko DM, Rumbaugh VE [2010]. Utilizing adequate intake line curtain air quantities to maintain respirable dust compliance. In: Hardcastle S, McKinnon DL, ed. Proceedings of the 13th United States/North American Mine Ventilation Symposium, Sudbury, Ontario, Canada, June 13–16.
- Seiter J, Smith M, Kim E, Cox S [2015]. Dust and noise hazard exposure: Comparison of PDC vs. WC roof bolt bits in laboratory. *Min Eng* 67(2):28–33.
- Tessum MW, Raynor PC [2017]. Effects of spray surfactant and particle charge on respirable coal dust capture. *Safety and Health at Work* 8(3):296–305.  
<https://doi.org/10.1016/j.shaw.2016.12.006>

- Thaxton RA [1984]. Maintenance of a roof bolter dust collector as a means to control quartz. In: Proceedings of the Coal Mine Dust Conference, Morgantown, WV, October 8–10, pp. 137–143.
- Tien JC, Kim J [1997]. Respirable coal dust control using surfactants. *Appl Occup Env Hyg* 12(12):957–963.
- USBM [1969]. Face ventilation in underground bituminous coal mines: airflow and methane distribution patterns in immediate face area–line brattice. By Luxner JV. Pittsburgh, PA: U.S. Department of the Interior, Bureau of Mines, Report of Investigations 7223.
- USBM [1976]. Effect of location and type of water sprays for respirable dust suppression on a continuous mining machine. By Matta JE. Pittsburgh, PA: U.S. Department of the Interior, Bureau of Mines, Technical Progress Report 96.
- USBM [1983a]. Spray fan aids in effectively controlling methane. Pittsburgh, PA: U.S. Department of the Interior, Bureau of Mines, Technology News 162.
- USBM [1983b]. Laboratory tests for selecting wetting agents for coal dust control. By Zeller W. Minneapolis, MN: U.S. Department of the Interior, Bureau of Mines, Report of Investigations RI 8815.
- USBM [1985]. How twelve continuous miner sections keep their dust levels at 0.5 mg/m<sup>3</sup> or less. Pittsburgh, PA: U.S. Department of the Interior, Bureau of Mines, Technology News 220.
- USBM [1986]. Impact of background sources on dust exposure of bag machine operator. By Cecala AB, Thimons ED. Pittsburgh, PA: U.S. Department of the Interior, Bureau of Mines, Information Circular 9089.
- USBM [1989]. Underboom sprays reduce quartz dust on continuous mining machines. Pittsburgh, PA: U.S. Department of the Interior, Bureau of Mines, Technology News 323.
- USBM [1990a]. Sources and characteristics of quartz dust in coal mines. By Organiscak JA, Page SJ, Jankowski RA. Pittsburgh, PA: U.S. Department of the Interior, Bureau of Mines, Information Circular 9271.
- USBM [1990b]. Laboratory evaluation of quartz dust capture of irrigated-filter collection systems for continuous miners. By Colinet JF, McClelland JJ, Erhard LA, Jankowski RA. Pittsburgh, PA: U.S. Department of the Interior, Bureau of Mines, Report of Investigations 9313.
- USBM [1992a]. Dust considerations when using belt entry air to ventilate work areas. By Potts JD, Jankowski RA. Pittsburgh, PA: U.S. Department of the Interior, Bureau of Mines, Report of Investigations 9426.
- USBM [1992b]. Breakthrough in roof-bolt drilling technology provides 200 to 400 times greater bit life. Minneapolis, MN: U.S. Department of the Interior, Bureau of Mines, Technology News 401.
- USBM [1996]. Suppression of longwall respirable dust using conventional water sprays inoculated with surfactants and polymers. By Kilau HW, Lantto OL, Olson KS, Myren TA, Voltz JI. Minneapolis, MN: U.S. Department of the Interior, Bureau of Mines, Report of Investigations 9591.

## CHAPTER 5: CONTROLLING RESPIRABLE DUST AT SURFACE MINES

Workers at surface mines are involved in the drilling and removal of overburden rock, so exposure to respirable crystalline silica (quartz) is a major concern. NIOSH had previously called attention to 23 cases of silicosis found in surface drill operators, including two that died from silicosis before the age of 40 [NIOSH 1992]. Additional health surveillance studies of surface mine workers have documented the ongoing occurrence of lung disease from respirable dust exposures at surface mines, as follows:

- In 1996 and 1997, health screenings were conducted of current and former bituminous and anthracite surface coal miners in Pennsylvania [CDC 2000]. Data from 1,236 examined miners showed radiographic evidence of silicosis in 6.7% of these miners. Operation of a highwall drill had a significant impact on the prevalence of silicosis. For 792 miners reporting no drilling experience, silicosis was diagnosed in 4.7% of these miners. For the 26 miners that reported more than 20 years of drilling experience, 46% were diagnosed with silicosis.
- In 2010 and 2011, NIOSH obtained chest radiographs from 2,257 current surface coal miners with more than one year of experience from mines located in 16 different states [CDC 2012]. Forty-six of these workers were diagnosed with coal workers' pneumoconiosis, including 37 of the 46 that had never worked underground. Twelve of these miners were diagnosed with progressive massive fibrosis (PMF), including nine that never worked underground.
- From 2014 through 2019, NIOSH collected chest radiographs for 6,790 surface miners through the Coal Workers' Health Surveillance Program. Results showed that 109 miners had radiographic evidence of pneumoconiosis, including 12 with PMF [Hall et al. 2020].

This historic and recent data confirms that respirable dust exposure from surface mining alone is leading to severe lung disease.

With the passage of the Federal Coal Mine Health and Safety Act of 1969 (Public Law 91-173), a gravimetric sample containing over 5% quartz was considered excessive quartz exposure and resulted in the calculation and enforcement of a reduced respirable dust standard. This was an indirect means of limiting quartz exposure to a maximum of 100 micrograms per cubic meter of air ( $\mu\text{g}/\text{m}^3$ ). In 2014, the Mine Safety and Health Administration (MSHA) promulgated a dust rule [79 Fed. Reg.<sup>16</sup> 24814 (2014)] in which 100  $\mu\text{g}/\text{m}^3$  of quartz was specifically defined as the limit for quartz exposure and the threshold value for implementing a reduced dust standard. For samples collected after August 1, 2014, MSHA has reported both the quartz percentage and concentration.

Historically, highwall drill and bulldozer operators were occupations at risk for elevated respirable quartz dust exposure [Tomb et al. 1986; Tomb et al. 1995]. Consequently, in section 71.206 of the 2014 dust rule, MSHA identified these occupations as designated work positions (DWP) that must be sampled on a periodic basis. Inspector quartz sampling results for these two

---

<sup>16</sup> Federal Register. See Fed. Reg. in references.



DWP occupations were downloaded from the MSHA website [MSHA 2020] and analyzed based upon quartz content as shown in Table 5.1. This data analysis shows that 56% and 78% of bulldozer and highwall drill operator samples, respectively, contained greater than 5% quartz. Surprisingly, only 4.3% and 6.0% of these samples exceeded a quartz concentration above 100  $\mu\text{g}/\text{m}^3$ . MSHA data from 1988 to 1992 showed similar results for the percentage of samples exceeding 5% quartz for the bulldozer (71%) and highwall drill (82%) operators [Ainsworth et al. 1995]. However, the percentage of these samples exceeding 100  $\mu\text{g}/\text{m}^3$  was 10 times higher for both the bulldozer (45%) and drill operators (63%). This data suggests that application of respirable dust control technology over the past 25 years has led to reduced quartz dust exposures and highlights the importance of implementing successful control technologies at surface mines.

**Table 5.1. Quartz samples collected between August 1, 2014, and December 31, 2019, by MSHA inspectors for bulldozer and highwall drill operators [MSHA 2020]**

Quartz range, %	Number of bulldozer operator samples	Number > 100 $\mu\text{g}/\text{m}^3$	Percent > 100 $\mu\text{g}/\text{m}^3$	Average quartz, $\mu\text{g}/\text{m}^3$	Number of highwall drill operator samples	Number > 100 $\mu\text{g}/\text{m}^3$	Percent > 100 $\mu\text{g}/\text{m}^3$	Average quartz, $\mu\text{g}/\text{m}^3$
0.0–5.0	998	1	0.1	7	363	0	0.0	11
5.1–15.0	804	7	0.9	22	871	17	2.0	25
15.1–25.0	240	21	8.8	48	315	37	11.7	59
25.1–35.0	122	17	13.9	71	91	30	33.0	103
+35.1	108	52	48.1	123	35	16	45.7	140
Total	2,272	98	4.3	25	1,675	100	6.0	35

These high quartz percentages emphasize the importance of controlling respirable dust exposure from several main sources, including drilling, hauling, and dumping. A number of primary control technologies have been developed and successfully implemented by surface mine operations. These include isolating workers from dusty atmospheres, utilization of dust collectors, and wetting to suppress or capture dust. Application of dust controls for the various sources encountered at surface mines is discussed in the remainder of this chapter.

It should also be noted that surface mining for coal, metal, and nonmetal operations has many similarities, including applicable dust control technologies. As a result, some of the material presented in this chapter has been adapted from a recently updated dust control handbook for industrial minerals mining and processing [NIOSH 2019], NIOSH RI 9701, which can be accessed for additional information.

## Enclosed Cabs for Equipment Operators

### Performance Measures

For mobile equipment operators at surface mines, utilization of an enclosed cab with properly applied filtration and pressurization is likely the most important control that can be used to reduce operator dust exposures. An enclosed cab can isolate the equipment operator from dust present outside of the cab and provide a protected, conditioned work environment inside the cab. The same type of protection can be provided to operators in stationary booths, such as crusher operators. As with other control technologies discussed in this handbook, dust control efficiency can be calculated to evaluate enclosed cab performance. In addition, protection factor (PF) is another term often used to define enclosed cab performance. With respect to enclosed cabs, these performance measures are calculated with the following formulas:

$$\text{Efficiency (\%)} = \left( \frac{C - X}{C} \right) * 100$$

$$\text{Protection factor (PF)} = \frac{C}{X}$$

where C = respirable dust concentration outside of the cab and X = respirable dust concentration inside the cab. Table 5.2 shows the numerical relationship between these two measures.

Throughout the remainder of this section, PF will generally be used to discuss enclosed cab performance.

**Table 5.2. Comparison of enclosed cab performance measures**

Efficiency, %	Protection factor
50	2
75	4
90	10
95	20
99	100
99.9	1,000

In addition to dust capture, filtration systems must provide enough intake air to prevent the build-up of carbon dioxide in the enclosed cab. A minimum intake air quantity of 25 cubic feet per minute (cfm) per person is recommended by the American Society of Agricultural and Biological Engineers (ASABE) [ASABE 2013].

### Cab Integrity

To optimize the protection afforded within an enclosed cab, effort should be made to ensure the integrity of the cab and the development of positive pressure within the cab. NIOSH found that a key to enclosed cab performance is to minimize the open spaces in the cab structure and potential dust leakage into the cab, particularly when high winds are present. In multiple field studies, it has been shown that development of positive pressure within the cab is a key factor in improving

the protection for the operator. Table 5.3 summarizes results from several NIOSH field studies where filtration and pressurization systems were retrofitted to existing cabs. The data is presented by increasing PF, with the equivalent efficiency value also listed for comparison.

This data illustrates the low levels of respirable dust that can be achieved inside of a properly sealed cab that develops positive pressure with an effective filtration and pressurization system installed. For the last three studies listed in Table 5.3, positive pressures in the cab were at 0.10 inches of water column (in. wc) or higher and resulted in PFs above 17, equivalent to dust control efficiencies in the mid to high 90s. Average dust levels inside the cab were equal to or less than 0.16 milligrams per cubic meter of air ( $\text{mg}/\text{m}^3$ ), despite average dust levels outside of the cabs being between 2.80 and  $6.25 \text{ mg}/\text{m}^3$ .

**Table 5.3. Respirable dust sampling results for retrofitted filtration systems for enclosed cabs on mobile surface mining equipment**

Equipment tested	Reference	Cab pressure, in. wc	Average inside cab dust, $\text{mg}/\text{m}^3$	Average outside cab dust, $\text{mg}/\text{m}^3$	Protection factor	Efficiency, %
Rotary drill	Organiscak et al. [2004]	None detected	0.08	0.22	2.8	63.6
Haul truck	Chekan and Colinet [2003]	0.01	0.32	1.01	3.2	68.3
Front-end loader	Organiscak et al. [2004]	0.015	0.03	0.30	10.0	90.0
Rotary drill	Cecala et al. [2009]	0.10–0.40	0.16	2.85	17.8	94.4
Rotary drill	Cecala et al. [2003]	0.20–0.40	0.05	2.80	56.0	98.2
Rotary drill	Cecala et al. [2005]	0.07–0.12	0.07	6.25	89.3	98.9

Therefore, it is important to ensure that door gaskets are in good condition and that cracks/open areas in the cab structure are sealed as well as possible. Closed-cell foam and caulking can be used to seal these areas. It is also important to ensure that there are not leaks in the filtration and pressurization units. Periodic inspections should be completed to check gaskets and seals and look for signs of dust leakage into the system. Finally, if the cab is equipped with a window, it must be stressed to the operator that the window should not be opened as this compromises the system and allows dust to enter the cab. Opening of the door should also be minimized to maintain positive pressure and prevent dust infiltration into the cab.

A monitor can be installed to measure the differential pressure between the outside environment and the inside of an equipment cab. The monitor can show the equipment operator that positive pressure is being maintained or identify a potential problem in the system. A detailed discussion of testing of pressure monitors and their use is available in Chapter 10 of NIOSH RI 9701 [NIOSH 2019].

## Filtration and Pressurization Systems

Experience gained from the field studies conducted by NIOSH led to the development of a cab test structure that could be used in controlled laboratory tests to evaluate the different parameters that impact cab effectiveness for reducing dust exposures, including intake and recirculation filter efficiencies. Results from a series of laboratory tests indicated that enclosed cab effectiveness is impacted by intake filter efficiency, air leakage around the intake filter, intake filter loading, recirculation filter usage, and wind infiltration into the cab [NIOSH 2008]. NIOSH subsequently measured the long-term performance of enclosed cabs that were equipped with three filters (intake, recirculation, and final filters) and installed on a face drill and roof bolter at an underground limestone mine. Results from this testing indicated that protection factors greater than 100 were achieved with the three-filter systems on this equipment [Cecala et al. 2012]. A schematic of the three-filter system is shown in Figure 5.1.

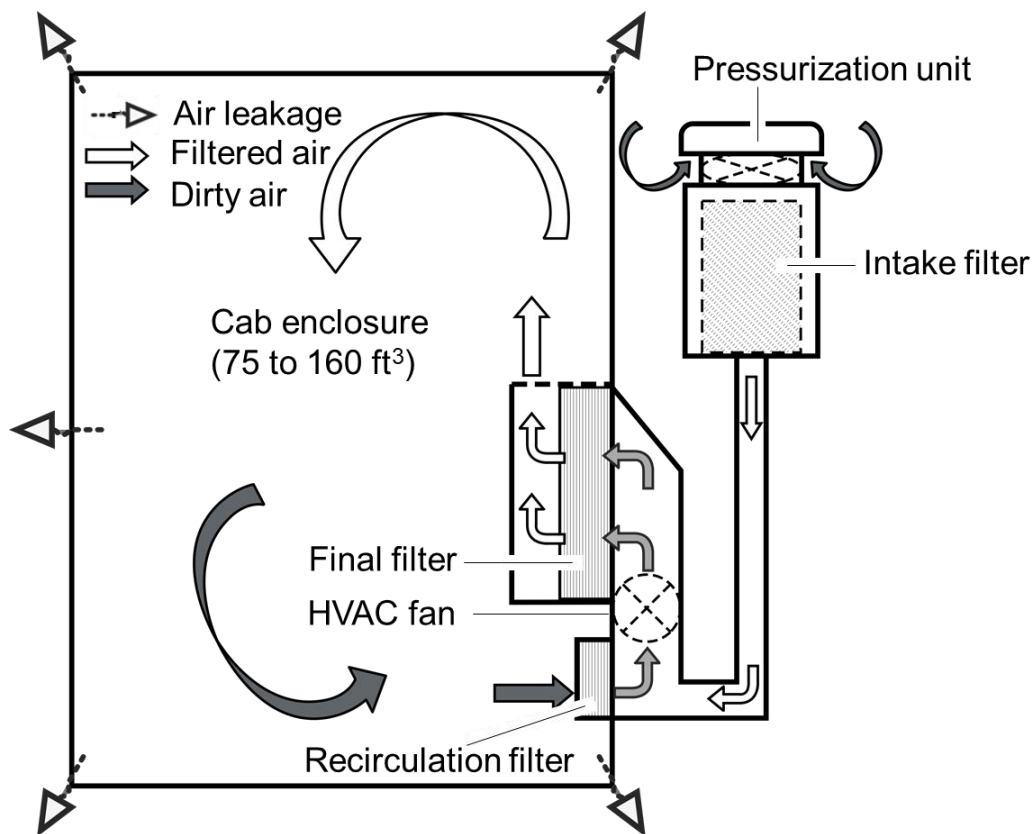

**Figure 5.1. Layout of three-filter system for an enclosed cab field tested by NIOSH.**

The laboratory and field data were used to develop and validate mathematical models that use a node analysis technique to predict system performance. Key model parameters identified for a three-filter system [Organiscak et al. 2014] are graphically illustrated in Figure 5.2.

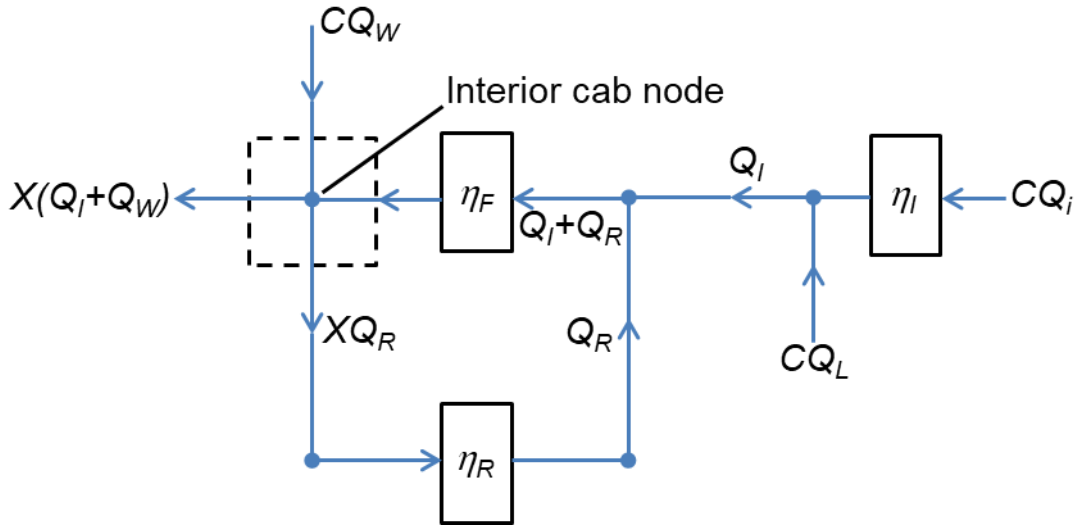

**Figure 5.2. Three-filter (I—intake, R—recirculation, F—final) cab system with Q (I, R, and W—wind, L—leakage, and i—filtered air) denoting air quantities, X (inside cab) and C (outside cab) denoting dust concentrations, and  $\eta$  denoting filter efficiency.**

The mathematical model developed for the three-filter system is shown in Equation 5.1 [Organiscak et al. 2014]. If a system does not have a final filter, a 0 value is inserted for the final filter efficiency, and the model then reduces to a two-filter system. If a system does not have both a final and recirculation filter, inserting 0's for these filter efficiencies reduces the model to a single filter system. Likewise, if no wind infiltration is occurring, a 0 can be inserted for QW, thus eliminating this contamination into the cab concentration. A more comprehensive model that incorporates leakage around the recirculation and final filters was also developed to calculate the impact of leakage around these filters and is discussed in the NIOSH Information Circular 9531 [NIOSH 2018].

$$PF = \frac{C}{X} = \frac{Q_I + Q_R(\eta_R + \eta_F - (\eta_R\eta_F)) + Q_W}{Q_I(1 - \eta_I + (l\eta_I))(1 - \eta_F) + Q_W} \quad (5.1)$$

where: C = outside dust concentration entering the filtration system and cab, mg/m<sup>3</sup>;

X = inside cab dust concentration (interior cab node), mg/m<sup>3</sup>;

$\eta$  = filter reduction efficiency, fractional;

1- $\eta$  = filter penetration, fractional;

Q = airflow quantity, cfm;

l = intake air leakage, fractional;

with the following filter efficiency and air quantity subscripts:

I = intake;

F = final;

R = recirculation; and

W = wind.

To illustrate how the mathematical model can be used to calculate the protection factor for a filtration and pressurization system, an example calculation is provided with the following parameters: intake and final filters with efficiencies of 95%, recirculation filter efficiency of

75%, cab intake airflow of 50 cfm, recirculation airflow of 200 cfm, a 5% outside air leak around the intake filter, and no wind infiltration. Inserting these values into Equation 5.1 would result in a calculated protection factor of 1,015 as shown below and in Table 5.4.

$$PF = \frac{50 + 200 \times (0.75 + 0.95 - (0.75 \times 0.95)) + 0}{50 \times (1 - 0.95 + (0.05 \times 0.95)) \times (1 - 0.95) + 0} = 1,015$$

Table 5.4 also shows the resulting protection factors for changes in the values of some of the model parameters and illustrates how the performance can be impacted by these changes [NIOSH 2019]. For example, when reducing the recirculation airflow to 100 cfm, the protection factor falls to 610 with all other parameters unchanged. When removing the recirculation filter with the rest of the original conditions unchanged, the protection factor is equal to 985. This change only results in a slight drop from the original PF because the final filter is still in place to capture dust before the air is discharged into the cab. However, because the recirculation filter has a lower efficiency than the final filter, removing the final filter from the system results in a PF of only 41 with all other conditions kept at the original levels. With only a single intake filter utilized, the PF drops to 10. This illustrates how the model can be used to indicate the relative impact on dust levels inside the cab for potential changes to the system.

**Table 5.4. Resulting protection factors for changes in enclosed cab model [NIOSH 2019]**

Intake filter efficiency, %	Recirculation filter efficiency, %	Final filter efficiency, %	Intake air quantity, cfm	Recirculation air quantity, cfm	Protection factor
95	75	95	50	200	1,015
95	No filter	95	50	200	985
95	75	95	50	100	610
95	75	No filter	50	200	41
95	No filter	No filter	50	200	10

As noted in Table 5.3, enclosed cabs that developed 0.1 in. wc of positive pressure or higher resulted in very good PFs and low dust levels in the cab. Positive pressure at this level would prevent outside dust penetration into the cab for a wind velocity of 14.4 miles per hour (mph). Equation 5.2 can be used to quantify the equivalent wind velocity from which a cab is protected for a given positive pressure within the cab [NIOSH 2019].

$$\text{Wind velocity equivalent (mph)} = (4000\sqrt{\Delta p_{cab}}) fpm \times 0.011364 \frac{\text{mph}}{\text{fpm}} \quad (5.2)$$

(@ standard air and temperature and pressure)

where  $\Delta p_{cab}$  = cab static pressure, in. wc; and

where  $fpm$  = feet per minute.

## Filter Selection

The data in Table 5.4 illustrates the positive impact that a second or third filter added to the system can make in reducing dust levels within an enclosed cab. To achieve these improvements, the appropriate filters must be chosen and maintained to sustain consistent dust control within the cab. NIOSH recommends the use of mechanical filters as opposed to electrostatic filters. Mechanical filters become more efficient in capturing respirable dust as the filter becomes coated with a dust cake. However, as the filter loads with dust, the pressure drop across the filter increases which can result in a reduction in airflow through the system.

Filters can be obtained that have different levels of collection efficiency and are typically tested with particles at or greater than 0.3 micrometers ( $\mu\text{m}$ ) in size. High-efficiency particulate air (HEPA) filters are designed to remove at least 99.97% of particles of 0.3  $\mu\text{m}$  in size, with even greater capture of particles larger in size as reported by the Environmental Protection Agency (EPA) [EPA 2020]. Another measure of filter collection efficiency is the minimum efficiency reporting value (MERV), which tests filters for collection efficiency on particles ranging from 0.3 to 10.0  $\mu\text{m}$  in size, encompassing the respirable size range as defined in Table 2.1. The highest-rated filter using this test method is the MERV-16 filter, which is rated with a capture efficiency of 95% or greater for particles in the 0.3- to 10.0- $\mu\text{m}$  size range [NAFA 2020].

Based solely upon collection efficiency, it may be assumed that utilization of HEPA filters in enclosed cab filtration systems would be the obvious choice. However, as was discussed with flooded-bed scrubber performance in Chapter 4, the overall performance of a fan-powered dust collector is determined by a combination of the collection efficiency of the filter media and the amount of air moved through the system. Because of the extremely high collection efficiency of a HEPA filter, the filter media is more restrictive from an airflow perspective. When utilized in mining environments where relatively high dust levels are present when compared to ambient air dust levels typically sampled for EPA requirements, the HEPA filter can load much more quickly and reduce airflow through the system. Also, the increased pressure across the HEPA filter creates a higher potential for airflow leakage around the filter.

In a two-year-long study by NIOSH comparing the performance of HEPA and MERV-16 filters on equipment in an underground limestone mine [Cecala et al. 2016], the HEPA filter had to be changed three times during the study as a result of dust and diesel exhaust loading, leading to decreased intake airflow. During this time period, the MERV-16 filter did not have to be changed as the intake airflow did not drop below a predetermined threshold limit. At the 95-confidence level, there was no statistical difference between the protection factors obtained with the two types of filters. The MERV-16 filters were less restrictive, provided greater cab airflow, required less frequent replacement, and were less expensive than the HEPA filters. Therefore, MERV-16 filters would typically be the preferred choice for use in enclosed operator cabs in mining applications [NIOSH 2019].

## Air Intake and Discharge Locations

As noted in the previous section, dust loading on the filters impacts airflow through the system and the frequency at which filters must be changed. Therefore, it would benefit the long-term performance of filtration and pressurization systems to place the inlet for the intake air in as low a dust zone as possible [NIOSH 2001a]. Typically, this would mean elevating the intake air inlet as high as possible, because the greatest dust generation is typically occurring near ground level for surface mining equipment such as drills, bulldozers, and trucks. For drills, a novel option is to elevate the air inlet to the top of the drill mast [Massey 2017]. Elevated inlets would reduce the amount of dust that needs to be filtered out of the intake air, thus extending filter life and reducing maintenance requirements.

In Chapter 4, using canopy air curtains to provide a filtered airstream down over the breathing zone of an equipment operator was discussed. The opportunity to apply this same principle in an enclosed cab also exists. The filtered air discharge can be located at the top of the cab with the inlet for the recirculation air located at the bottom of the cab [Cecala et al. 2009]. This would result in filtered air moving down over the operator and would thus minimize potential dust exposure from sources inside the cab, which are discussed in the next section.

## Internal Dust Sources

The need to protect mobile equipment operators from respirable dust outside of the enclosed cab is obvious. However, it may not be obvious that dust can be generated inside the cab and expose equipment operators. Three sources of this dust are the dirt/mud that is tracked into the cab on the shoes of the operator, dust-contaminated cloth seats, and dusty work clothes.

When the dirt on the floor is disturbed by operator movement, dust can be entrained into the air, increasing the dust concentration inside the cab. As noted previously, NIOSH has conducted studies of enclosed cabs on multiple types of equipment. A cab on a surface drill was equipped with a heater positioned on the floor of the cab. As NIOSH sampling of this drill extended from the summer into winter, higher dust levels were measured inside the cab. It was found that operation of the floor heater fan was blowing dust from dirt on the floor throughout the cab [NIOSH 2001b]. NIOSH applied a gritless sweeping compound (without sand) to the floor to reduce dust from this source [NIOSH 2001c] but recommends regular cleaning of the cab floor and not using floor-mounted heaters as preferred alternatives to applying sweeping compound.

NIOSH has also observed dust being liberated from cloth seats that have been contaminated with dirt and dust. As the operator sets and moves in the seat, dust can be dispersed from the soiled chair into the air, potentially exposing the operator. Vinyl-covered seats can reduce the dust from this source.

Dust-contaminated work clothes can also be a source of dust liberation as workers move within the cab. The potential impact of dusty clothes along with several references was discussed in the Cleaning the Dust Box section in Chapter 4. A clothes cleaning system has been developed and tested by NIOSH [Cecala et al. 2008; NIOSH 2019] and could be used for cleaning dust from work clothes at surface mining operations.

Utilization of a recirculation and/or final filter in the cab filtration system will more quickly and effectively remove respirable dust that may be generated from sources inside of the cab and further illustrate the value of these filters.



## Dust Control for Highwall Drills

Surface drills can be a large source of dust generation and highwall drill operators have historically been at risk for elevated respirable dust exposure. The greatest source of dust exposure results from dust and drill cuttings being flushed out of the drill hole by compressed air, known as bailing air, which is directed down the drill pipe. This air reaches the bit-rock interface and flushes the broken material up and out of the drilled hole to improve drilling efficiency and speed. Unfortunately, from a dust control perspective, the dust and drill cuttings are discharged from the hole at a high velocity making control of this dust more difficult.

The most common type of dust collection used on surface drills in the U.S. is a dry vacuum collection system. Wet drilling is less popular but another option for controlling dust generation from drilling. Each of these systems has been shown capable of reducing respirable dust levels by over 95% when operating properly [Zimmer and Leuck 1986]. The design and key operating factors for each of these systems will be presented.

### Dry Dust Collection System

A schematic of a typical dry collection system for a surface drill is provided in Figure 5.3. Bailing air flows down the drill pipe and through ports in the drill bit to force dust/cuttings out of the drilled hole through the annular space between the drill pipe and surrounding rock. To improve the capture of this dust by the collector, a shroud is hung from the drill deck to confine the discharged dust. The shroud is typically constructed from conveyor belting which should completely enclose the area under the drill deck area. The most effective shroud will reach from the drill deck to the ground and not have any open seams, thus providing the greatest dust confinement and capture potential for the dust collector. Flexible ductwork transports the captured dust from the enclosed drill deck to the collector. Filter media within the collector removes dust from the airstream with filtered air discharged into the ambient air. The dust captured by the filters is typically removed by compressed air that back-flushes the filters. This dust falls to the bottom of the collector where it is periodically dumped from the collector onto the ground.

The potential sources of dust escaping these dry collector systems include gaps between the shroud and ground, gaps in the shroud itself, gaps between the drill pipe and drill stem bushing, and dust discharging from the collector dump. Controls for each of these locations and the critical importance of dust collector-to-bailing airflow ratio are discussed.

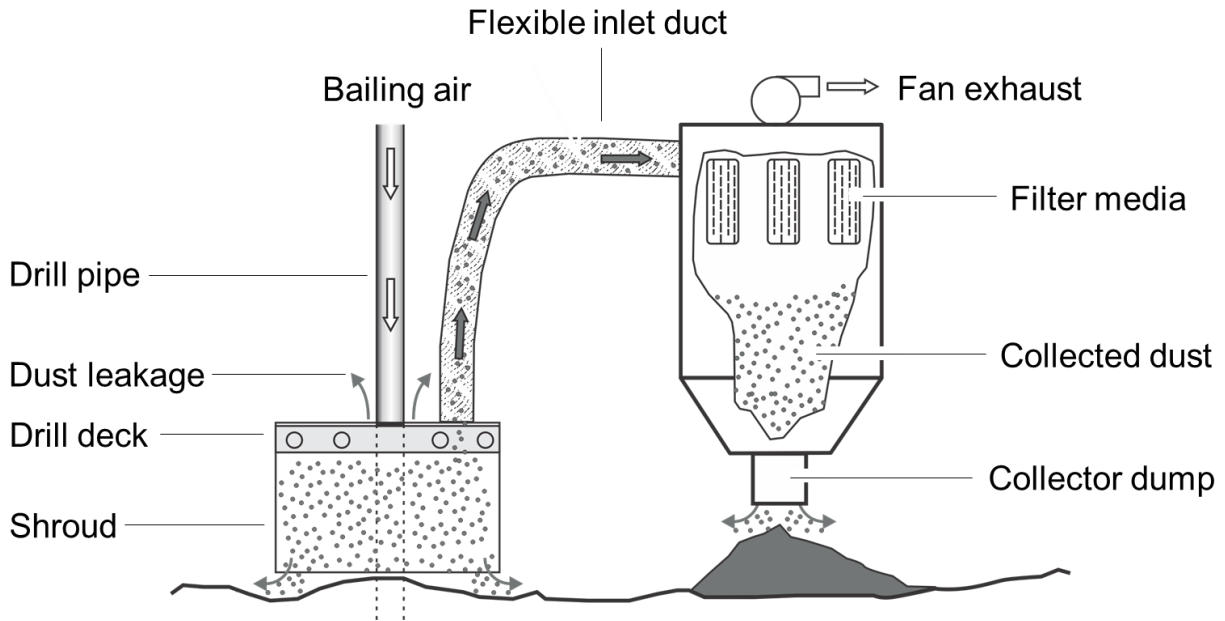

**Figure 5.3. Components of a typical dry dust collection system for a surface drill.**

### *Drill Deck Shroud*

As previously noted, bailing airflow is used to flush dust and cuttings out of the drill hole. The volume of bailing air and the small area of the annulus opening around the drill pipe lead to the bailing air exiting the hole at very high velocities, which can be over 4,500 fpm [NIOSH 2005]. NIOSH research has shown that a significant portion of this high-velocity airstream flows out of the hole up the side of the drill pipe and then flows along the underside of the drill deck and down the inside edge of the shroud where it strikes the ground as shown in Figure 5.4, left [Potts and Reed, 2008]. Dust then escapes the shroud through the gap between the drill shroud and the ground. Likewise, if there are gaps between sections of the shroud, dust can flow through these gaps into the ambient air.

Consequently, a very important part of controlling drill dust is to ensure that a competent shroud is maintained that minimizes the gap between the shroud and ground and has no gaps or tears in the shroud itself. To account for uneven terrain, flexible shrouds that are mechanically raised and lowered can be used to minimize the shroud-to-ground gap height [NIOSH 1998; NIOSH 2005]. The amount of leakage resulting from the height of the shroud-to-ground gap is impacted by the collector-to-bailing airflow ratio and are discussed more completely in that section later in the chapter.

In order to prevent gaps within the shroud, the seams should be overlapped. Most shrouds are rectangular to match the perimeter of the drill deck. A single piece of belting can potentially be installed with the one seam overlapped to avoid a gap in the material. The more common type of shroud has four separate pieces of belting with one piece attached to each side of the drill deck. However, this creates the potential for gaps to form at the corners where two pieces of belting meet as the drill positions on uneven ground in preparation for drilling. One solution to preventing these gaps from occurring is to install corner pieces of belting that are independent of the side-mounted pieces as shown in Figure 5.4, right. These extra pieces of belting help confine the dust within the shroud.

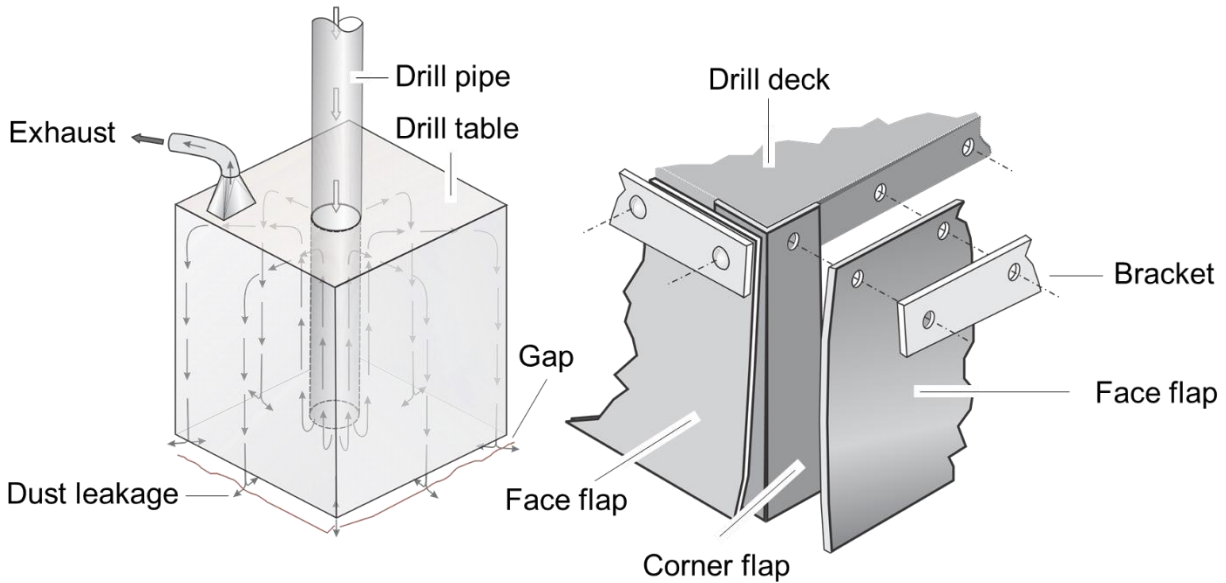

**Figure 5.4. Airflow pattern within drill deck shroud leading to dust leakage (left) and corner flaps added to rectangular deck shroud to reduce dust leakage (right).**

### *Air-blocking Shelf*

As shown in Figure 5.4, left, the airflow pattern formed by the bailing air coming out of the drill hole carries dust down the drill shroud, where it strikes the ground and leaks out through gaps between the shroud and ground. In order to disrupt this airflow pattern, NIOSH developed an air-blocking shelf which is mounted inside the perimeter of the dust shroud [Potts and Reed 2008]. The air-blocking shelf was constructed from 6-inch-wide conveyor belting that was bolted to 2-inch angle iron, which was bolted to the inside perimeter of the shroud. Figure 5.5, left, shows the air-blocking shelf as it was installed on an operating drill for subsequent testing at a mine site. In the lab testing, a collector-to-bailing airflow ratio of 1.9:1 with a shroud-to-ground gap of two inches resulted in the blocking shelf reducing dust levels outside of the shroud by 81%. At a collector-to-bailing airflow ratio of 1.2:1 and a shroud-to-ground gap of eight inches, the dust reduction outside of the shroud fell to 38%. The lab testing also showed that vertical gaps in the shroud above the blocking shelf along with gaps between horizontal sections of the shelf as shown in Figure 5.5, right, resulted in no dust reductions with the air-blocking shelf. These results illustrate how the interaction between components of the dust control system can impact overall performance.

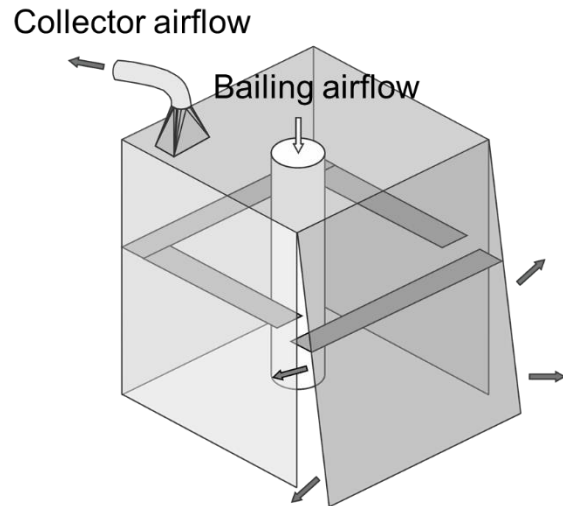

Photo by NIOSH

**Figure 5.5. Air-blocking shelf installed on drill shroud (left) and laboratory test configuration showing leakage through gaps in the drill shroud and blocking shelf (right).**

Subsequent testing of this initial design was conducted at two mines [Potts and Reed 2011]. At Mine A, respirable dust reductions of approximately 70% were measured at sampling locations around the drill. At Mine B, dust levels were much lower in general but a reduction of 81% was measured near the drill shroud. This testing also revealed two operational issues with the original air-blocking shelf design. Dust and drill cuttings had accumulated on the air-blocking shelf during drilling. As the drill mast was lowered, this dust fell from the shelf, releasing dust into the air as shown in Figure 5.6, left. When returning to Mine B four months after initial testing, the air-blocking shelf was still functioning but the angle iron had been bent through impact between the shroud and rock piles on the bench.

To address these issues, NIOSH redesigned the shelf so that it was constructed of 8-inch-wide high-density polyethylene (HDPE), was constructed as multiple overlapping pieces as opposed to long continuous pieces, and so that the pieces were mounted at a 45-degree angle as shown in Figure 5.6, right. The HDPE material has a slippery surface which reduces dust buildup, while the use of shorter sections reduce possible damage during tramming. Chains were added to help hold the shorter pieces at the desired 45-degree angle when the mast is in its drilling position. In the initial laboratory testing previously discussed [Potts and Reed 2008], testing that simulated the shroud mounted at a similar angle resulted in dust reductions only slightly lower than the original design (76% versus 81%). Therefore, angling the air-blocking shelf did not substantially impact dust control performance.



Photos by NIOSH

**Figure 5.6. Dust released when material drops off of air-blocking shelf (left) and modified design with short, overlapping sections supported by chains to maintain the 45-degree angle (right).**

### *Drill Stem Bushing*

The drill pipe extends with relatively tight clearance through a bushing mounted to the drill deck. This bushing helps to guide the drill pipe, can help dampen vibration, and provides a wear surface. As the bushing wears, the gap between the drill pipe and bushing increases. As noted previously, high-velocity bailing air is exiting the drill hole and flowing along the outside of the drill pipe to the underside of the drill deck. As the gap in the bushing increases, dust can be blown up through the bushing into the ambient air as shown in Figure 5.7. It is important to monitor the wear of the bushing and replace it as the wear becomes excessive.



Photos by NIOSH

**Figure 5.7. Dust leakage through drill stem bushing on two different drills.**

One method of reducing dust release through the bushing is to install a rubber shield under the drill deck as shown in Figure 5.5, left, to deflect material that would normally reach the bushing. Typically, conveyor belting is used with a round hole cut in the center of a piece of conveyor belting. Since the belting is flexible, it can have a tighter fit with the drill pipe to minimize the

amount of material bypassing it. However, because of the tighter fit, the conveyor belting is subject to quicker wear and must be replaced periodically.

A non-contact option for reducing leakage through the drill stem bushing is the application of an air ring seal that was developed through U.S. Bureau of Mines (USBM) research [Page 1991]. This technology used a circular steel ring that was mounted to the underside of the drill deck and was just large enough so that the drill bit and pipe passed through the center of the ring. Compressed air from the drill's compressor was supplied to the air ring and dispersed through a series of 1/16-inch-diameter holes that were spaced roughly 1/2-inch apart around the inside perimeter of the air ring as shown in Figure 5.8. High-velocity air jets exited the holes in the ring at a 45-degree angle toward the drill pipe to prevent cuttings and respirable dust from passing through to the drill stem bushing. When tested at an air pressure of 30 pounds per square inch (psi), the air ring was successful in reducing respirable dust levels and material deposition on top of the drill deck. For current applications, the amount of air available for the air ring seal will be dependent upon the drill and the capacity of its compressor.

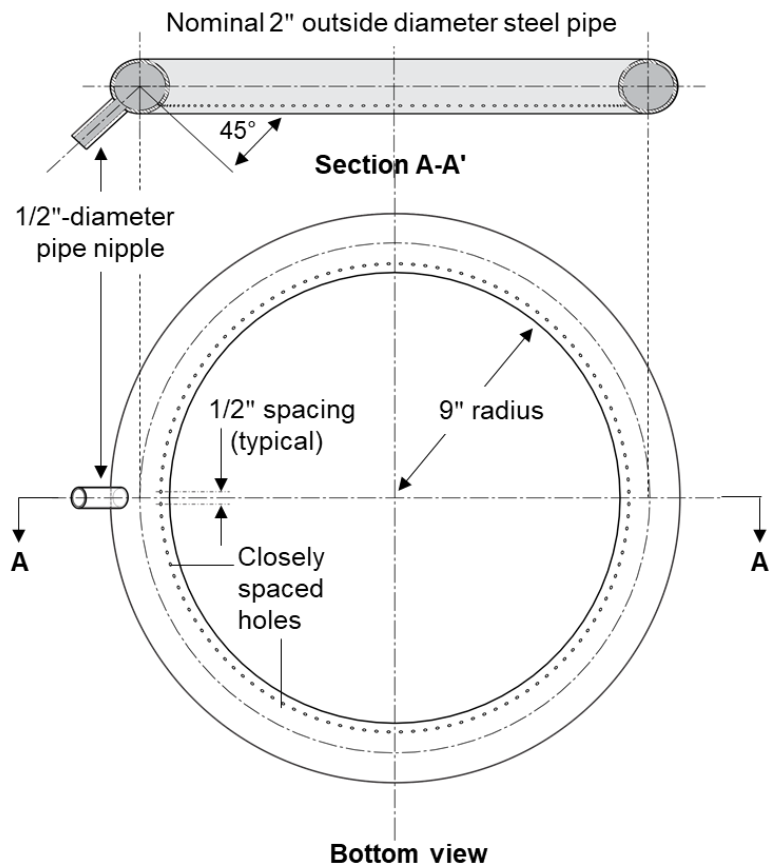

**Figure 5.8. Air ring seal designed to reduce leakage through drill stem bushing.**

### *Dust Collector Dump*

When the accumulated dust inside the dust collector is discharged from the collector dump, it typically must fall 2–3 feet through the air before striking the ground, allowing respirable dust to

disperse into the air. Obviously, dust composition, drop distance, wind speed, and wind direction will impact potential respirable dust entrainment and worker exposure.

A simple solution for reducing respirable dust entrainment during this process, which occurs repeatedly throughout a shift, is to create a “sock” or shroud that encloses the dust as it falls and reaches the ground. A section of brattice cloth can be attached to the dump discharge with a large hose clamp with the length of brattice long enough so that it touches the ground. The brattice should overlap itself to provide a competent seal and allow for expansion of the brattice as material builds at the ground level. Figure 5.9, left, illustrates a dust plume released during an unconfined dump and with brattice installed on the drill collector dump (Figure 5.9, right). Sampling within 2–3 feet downwind of the collector dump resulted in average respirable dust levels being reduced by nearly 80%, dropping from 0.92 mg/m<sup>3</sup> to 0.20 mg/m<sup>3</sup> [Reed et al. 2004].



Photos by NIOSH

**Figure 5.9. Dust at collector dump before (left) and after shroud installation (right).**

### *Collector-to-bailing Airflow Ratio*

Dust collector airflow is the quantity of air pulled from within the drill shroud by the fan of the dust collector. Bailing airflow is the quantity of air used to flush cuttings out of the drill hole, which is determined by the capacity of the air compressor installed by the manufacturer. The ratio between the dust collector airflow and the bailing airflow (collector airflow, cfm ÷ bailing airflow, cfm) is a key operating parameter for controlling respirable dust liberation at the drill deck.

A 1:1 ratio would indicate that these two airflows are balanced with equal quantities of air flowing into the shrouded drill deck and being pulled out to the collector. However, the preferred operating condition is to have the collector airflow be greater than the bailing airflow. In this operating state, air from outside of the drill shroud needs to flow into the shroud to meet the collector airflow demand. This airflow pattern would create negative pressure within the shroud and assist in keeping drilling dust from escaping through gaps in the shroud.

NIOSH has conducted research investigating the relationship between the collector-to-bailing airflow ratio and the height of the gap between the shroud and ground. As shown in Figure 5.10, optimum drill dust control was obtained with higher collector-to-bailing airflow ratios in combination with minimized shroud gap heights [Organiscak and Page 2005]. For increases in the collector-to-bailing airflow ratio, the largest dust reduction was observed when going from a 2:1 ratio to 3:1. This data also shows that as the shroud gap heights increased from 2 inches to 14 inches, substantial increases in dust outside of the shroud occurred, even at the maximum tested collector-to-bailing airflow ratio of 4:1.

This data suggests that mine operators should strive to achieve a collector-to-bailing airflow ratio of 3:1, while keeping the shroud gap height as close to 2 inches as possible. Unfortunately, 2:1 ratios were typical of drills found by NIOSH at mines [Page and Organiscak 2004], with poorly operating drills having ratios of 1:1 or lower.

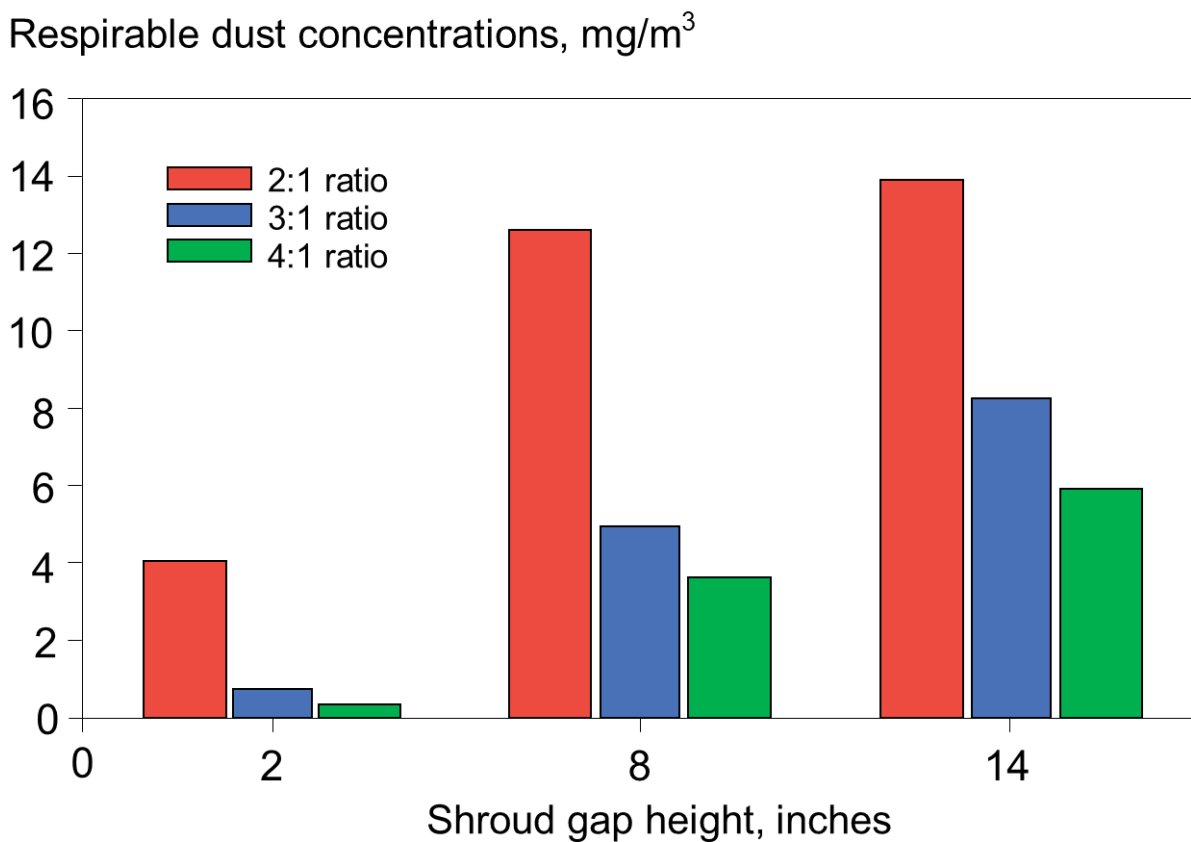

**Figure 5.10. Impact on dust levels outside of the drill shroud when changing the collector-to-bailing airflow ratio and drill shroud gap height.**

The data in Figure 5.10 illustrates the importance of maintaining the desired dust collector-to-bailing airflow ratio and a competent, properly positioned dust shroud. Typically, the bailing airflow is fairly consistent as long as the compressor is operating properly. However, several factors can impact the dust collector airflow and should be checked periodically to ensure proper operation:



- the collector inlet and tubing are free of obstruction,
- the intake duct and collector housing are tightly sealed and free of leaks,
- the dust collector filters are not damaged and are changed at recommended intervals,
- the collector filters are being backflushed properly and at specified intervals, and
- the collector fan is operating properly and to specification.

## Wet Drilling

Injecting water into the bailing air can be successful in reducing dust liberated by drilling at surface mines. After being injected through the drill pipe column to the bit, air and water droplets flush the cuttings and dust from the hole through the annular space between the drill pipe and surrounding rock. As the water and dust travel up the drill hole, particles are wetted by the water droplets, thus increasing drop-out when the airstream exits the hole. Dust reductions up to 96% were observed in research funded by the USBM [Zimmer et al. 1987]. However, there are several operational issues that must be addressed when using wet drilling, including the need to monitor and control water flow rate, the need to periodically fill the on-board water tank and protect against freezing in cold weather, and the need to protect tri-cone rotary drill bits from the injected water.

The amount of water added to the bailing air is critical from dust control and operational perspectives. Sufficient water must be added to effectively control generated dust, but too much water can lead to problems with flushing the cutting from the hole, drill pipe binding, increased bit wear, and hole degradation, depending upon the strata being drilled. At one mine, changing the water flow rate from approximately 0.2 gallons per minute (gpm) to 0.8 gpm for drills from two different manufacturers increased the average dust control for these drills from 24% to 91% [Zimmer and Lueck 1986]. A point of diminishing return in dust control efficiency for increasing water flow was observed at 0.6 gpm for one drill and 0.8 gpm for the second drill. This data illustrates the need to determine the optimum water flow rate for individual drills and also for changes in overburden composition.

The drill operator can manually adjust the water flow rate, and it has been recommended that water flow is slowly increased until visible dust emissions abate [NIOSH 2003]. It should be noted that a several-second delay between adjusting the water flow valve and the impact on dust emissions is present. This delay should be taken into account when adjusting water flow to prevent over-adjusting.

For wet drilling, a water pump injects water from a tank located on the drill into the bailing airflow. Although high water flow rates typically are not required as mentioned above, the water tank must periodically be refilled, typically from a water truck. Also, in regions where freezing temperatures occur, efforts must be made to prevent the water from freezing either through heating or the use of an anti-freeze additive.

## Water Separator Sub

The useful life of tri-cone bits can be shortened by 50% when wet drilling due to rapid degradation of drill bit bearings by hydrogen embrittlement and accelerated bit wear as a result of operating in the abrasive rock-water slurry environment at the drilling interface [USBM 1988]. To prevent this problem, the water injected into the bailing air must not reach the tri-cone bit, which is accomplished through the implementation of a water separator sub inserted

into the drill string. The sub is a short section of the drill column assembly that is placed between the drill pipe and drill bit.

Within the interior of the water separator sub, the water-laden bailing air is forced to make sharp turns before reaching the drill bit. The bailing air is capable of making these turns but the water droplets cannot because of their inertia and are separated out of the airstream. The positive pressure within the drill pipe created by the bailing air then forces the accumulated water out of weep holes in the walls of the separator sub (Figure 5.11, left). Although the water separator sub does not separate 100% of the water, a slight mist/fog is discharged through the bit with the majority of water being discharged through the weep holes (Figure 5.11, right). The water can then mix with the drill cuttings as they are transported out of the hole by the bailing air. Due to the internal space requirements for components in this original design of a water separator sub, it could only be used for drilling holes 10 inches in diameter or greater. Subsequently, an alternative water separator sub that uses centrifugal force to separate the water from the air was designed and could be used to drill holes as small as 6.625 inches in diameter [Listak and Reed 2007].

Tests results from three studies with a water separator installed showed the following:

- no difference in average dust levels when comparing wet drilling with and without the water separator installed [USBM 1988].
- up to a 25% reduction in average dust levels when comparing wet drilling with and without the water separator installed on a drill in Australia [Millgate and Hagan 2015].
- a substantial reduction in maximum dust levels observed when comparing wet drilling with the water separator sub to a dry collection system [Listak and Reed 2007].

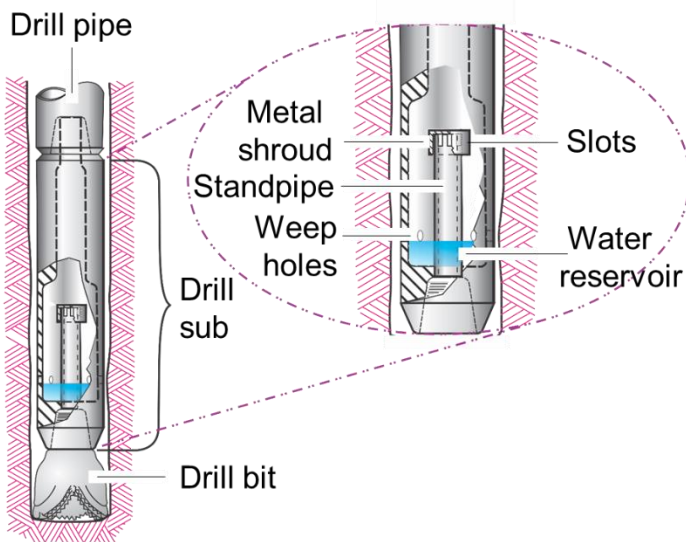

Photo by NIOSH

**Figure 5.11. Schematic showing internal components of water separator sub (left) and water being discharged through weep holes (right).**

In the USBM study, multi-year data on bit life was analyzed and indicated that use of the water separator sub increased average bit life from approximately 2,000 ft/bit to 9,000 ft/bit. In the Australian study, average bit life over a multi-month test period was increased by 58% when using the water separator sub. Therefore, the use of a water separator sub can increase bit life when compared to conventional wet drilling with no adverse impact on or even an improvement in respirable dust control.

## Haul Road Dust Control

Dust generated by equipment traveling over haul roads at surface mines can be a major source of dust emissions as shown in Figure 5.12, left, which can pose both health and safety concerns. If the generated dust contains quartz, truck driver operators and workers in the vicinity of the haul roads can be exposed. Depending upon the severity of dust generated on haul roads, visibility can become a safety concern as shown in Figure 5.12, right. The level of dust generation from haul roads is dependent upon the quality of the haul roads, the traffic traveling the haul roads, dust controls being used, and weather conditions. Each of these items is discussed.



Photos by NIOSH

**Figure 5.12. Examples of haul road dust generated by haul trucks. In the photo on the right, the green box outlines a pickup truck and illustrates the loss of visibility from dust obstruction.**

## Road Construction

When a vehicle travels on a haul road, the wheels exert compression and tension forces on the road surface. These forces can readily degrade roads constructed from weak materials, producing fine particles that can be entrained into the ambient air by equipment movement along the road. Alternatively, haul roads constructed of the proper materials degrade less rapidly, lessening the dust emission potential of the road. Although a properly constructed road has a higher initial cost, it requires less road maintenance over the same period of use and reduces equipment maintenance costs, including increased tire life.

Because haul roads at mines can be subjected to large-capacity vehicles (up to 400 tons), proper design and construction of these roads, including selection of appropriate materials, can have a significant impact on long-term road performance. A properly designed road will consist of a subgrade, a subbase, and a wearing surface constructed to recommended specifications. More detailed guidance for designing each of these road layers and an example of the associated calculations are provided in Chapter 11 of NIOSH RI 9701 [NIOSH 2019].

Because the wearing surface layer of the road has direct contact with the mining vehicles, the materials used in constructing this layer should possess certain physical properties: resistance to wear, soundness, maximum size, particle shape, and gradation [Midwest Research Institute 1981].

- A high *resistance to wear* indicates that the material will not easily disintegrate under the anticipated traffic load. Materials such as limestone or granite are desired as opposed to softer materials such as coal, shale, or vermiculite.
- *Soundness* is the ability of the material to withstand the region's climatic conditions (precipitation and temperature changes) and the material's ability to not easily be broken down from natural weathering processes.
- Generally, the *maximum size* of the aggregate to be used for the surface of the road is 1 inch, to facilitate maintenance with a road grader.
- Material that contains angular *particle shapes* with rough surfaces promotes the stability, density, and durability of the road.
- Road material containing a good representation of particle size fractions from large to small have a desirable *gradation* or size distribution.

In addition to haul roads, surface mines can have access roads that are used to transport personnel and supplies. Typically, the vehicles using access roads are lower in weight and traveling less frequently than production haul trucks. However, due to the dynamic nature of mining, these access roads may at times be used as haul roads and can be designed to haul road specifications. Otherwise, information for designing smaller access roads can be found in *Gravel Roads: Maintenance and Design Manual* [Skorseth and Selim 2000].

## Traffic Control

Although a properly constructed haul road can be effective in reducing dust generation, there are additional administrative controls that can further assist in controlling dust emitted from haul road use. These administrative controls include vehicle speed and traffic flow.

### Vehicle Speed

A majority of the fugitive dust from haul roads is generated through the forces of the wheels on the road surface and by the turbulence created by the vehicles [Moosmüller et al. 2005]. As the speed of haul trucks increases, the amount of turbulence and dust liberation also increases, as shown in Figure 5.13 [Thompson and Visser 2001]. In one study, reducing vehicle speed from 25 to 10 mph reduced the generation of dust particles < 10 µm by approximately 58%, and by 42% when speeds were reduced from 25 to 15 mph [Watson et al. 1996].

In another study, limiting speeds on unpaved roads to 25 mph reduced dust levels by 44% [Countess Environmental 2006]. Although reducing the speed of vehicles traveling on haul roads can be an effective method for dust control, these actions may impact the production rate of the mine.

### Traffic Flow

If haul trucks travel in close proximity to one another on unpaved roads, the dust plume created by the leading truck can engulf the trailing truck and expose this driver to elevated dust levels.

One study showed that maintaining a 20-second following distance between haul trucks resulted in up to a 52% reduction of respirable dust exposure to the trailing truck driver [Reed and Organiscak 2005]. Also, the dust cloud generated from the lead truck can impair the visibility of the trailing driver, but the 20-second or greater time interval between trucks can allow this dust to dissipate.

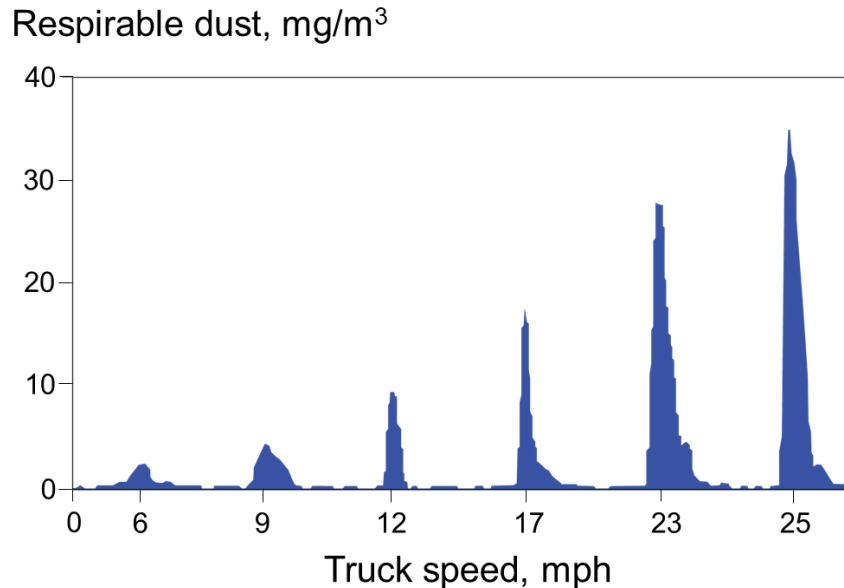

**Figure 5.13. Graph showing dust levels measured at the roadside for a haul truck traveling at various speeds [adapted from Thompson and Visser 2001].**

Additionally, the proper use and maintenance of filtration and pressurization systems on enclosed cabs of haul trucks are important for controlling the respirable dust exposure of truck operators. Therefore, the information on enclosed cabs provided earlier in this chapter should be used to maximize the protection afforded to haul truck drivers.

### Water Application

Watering roads with a water truck is the most common method used for haul road dust control. Water trucks consist of a tank capable of holding up to 90,000 gallons, a water pump, and plumbing designed to deliver water to spray nozzles mounted at the rear of the truck. The nozzle spray pattern and layout are typically designed to wet at least one lane of a haul road in one pass as shown in Figure 5.14. Although watering requires no road preparation prior to application, it must be reapplied on a consistent basis. Additionally, the dust control efficiency for water can be highly variable because it depends on road material type, traffic, and weather conditions.



Photos by Mega Corporation

**Figure 5.14. Water trucks wetting haul roads with rear-mounted water sprays (left) and a water distribution manifold (right).**

The nozzles used for watering roadways generally have fan spray patterns and are mounted on the truck in a stationary position. Various types of fan spray nozzles are fabricated by different manufacturers with examples shown in Figure 5.15. Alternatively, water can be applied through water distribution manifolds. Simple manifolds can be constructed by drilling holes along the bottom of a pipe that is then mounted on the back of the water truck as shown in Figure 5.14, right. Cutting horizontal slots in water stand-pipes (or endcaps) at the corners of the water truck can expand coverage. To achieve optimal spray coverage, it is best to orient the nozzles in a manner to minimize overlap of the water spray from other nozzles [James and Piechota 2008]. It is also important that the water reaches the desired target location and is not blown away by the ambient wind. As a result, lower water pressures, 15 psi or less, that produce larger-sized water droplets are often utilized [Franta 2016].



Photo by Access Truck Parts

Photo by Access Truck Parts

Photos by Spraying Systems Co.

**Figure 5.15. Various types of manufactured spray nozzles (not to scale) used to water roadways.**

There are no universal guidelines for the amount of water to use for dust control on haul roads nor for determining optimum haul road watering intervals. The quantity of water sprayed onto the road during each application, the composition and layout of the road, the traffic volume on the road, and the prevailing weather conditions are factors that should be used to determine site specific optimum intervals for watering [Cowherd et al. 1988]. Water application rates ranging from 0.02 to 0.50 gallons per yard squared (gal/yd<sup>2</sup>) have been utilized at surface mining operations in various countries [Bulger 2015; Midwest Research Institute 1981; Tannant and Regensburg 2001]. Figure 5.16 illustrates the importance of keeping the road wet at one operation as airborne respirable dust levels increased substantially as the road dried out after being watered at 10:00.

Regular light watering may be more effective for dust control than infrequent heavy watering and also reduces the potential hazards resulting from excess water (e.g., slick ramps, degradation of roadway) [Thompson and Visser 2007; Bolander and Yamada 1999]. Utilization of speed-sensitive watering systems can assist with the uniform application of water on haul roads. These systems adjust the quantity of water that is discharged onto the road in relation to the travel speed of the watering truck [Bulger 2015]. Another technique that has been recommended to reduce the potential of tire slippage, particularly critical on ramps, is intermittent or spot watering, which results in alternate wet and dry sections of roadway [Bennink 2007; Thompson 2020].

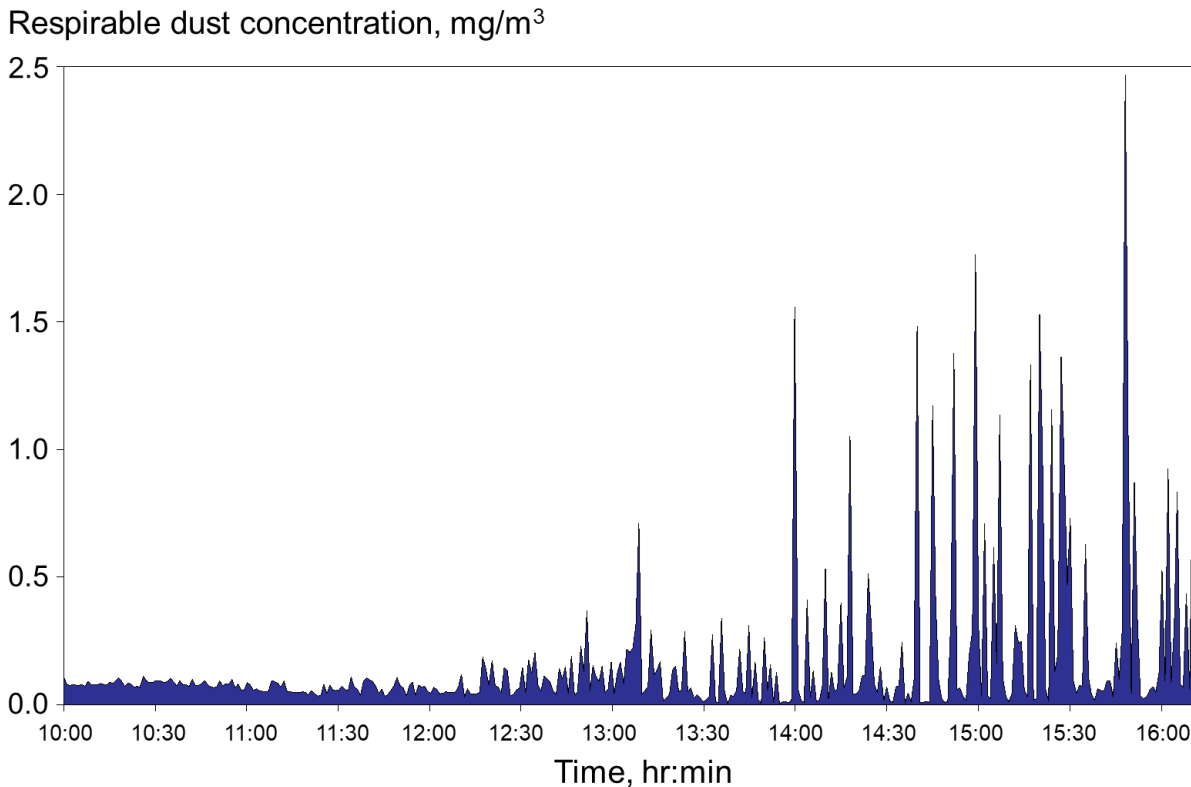

**Figure 5.16. Graph showing respirable dust concentrations measured along a haul road after water application occurred at 10:00 [from Organiscak and Reed 2004].**

### Chemical Dust Suppressants

A number of different chemicals, including salts, petroleum emulsions, polymers, and adhesives, are available for suppressing dust on haul roads. Each of these dust suppressants has specific application methods, but the haul road should be conditioned prior to the suppressant being applied. In general, the haul road surface should be prepared by the following:

- eliminating potholes and road corrugations through backfilling and blading as necessary,
- blading large material not suitable as a good road surface off the road, and
- establishing a crown on the road to eliminate standing water that leads to potholes and road degradation.

The manufacturer's instructions should then be followed for applying a specific suppressant in order to obtain optimum performance. A brief description of each type of suppressant will be provided.

### *Salts*

Salt solutions are commonly mixed with water to reduce haul road dust. Magnesium chloride and calcium chloride are the most common salt-based dust control agents. Advantages of using salt-based agents for dust control are that they absorb moisture from the atmosphere to maintain the road's moisture content at a higher-than-normal level, generally do not require time to cure after application, and can thaw snow and ice during winter. Conversely, chlorides may cause corrosion sooner than normal on equipment using the treated roads. They can also be harmful to vegetation and to personnel if skin or eye contact occurs. Chlorides are also water soluble and may leach from the road surface during precipitation, thereby degrading performance over time [Midwest Research Institute 1981].

### *Petroleum Emulsions*

Petroleum resins are engineered products or byproducts of lubrication oil manufacturing. They generally consist of stable emulsions of petroleum residuals, solvent extracts, and acid sludge. Haul roads have been reported to be relatively dust free for a period of three to four weeks when using petroleum emulsions [Midwest Research Institute 1981]. A primary advantage to using petroleum emulsions is that they are not corrosive. They are also not water soluble, are relatively nontoxic and nonflammable, and do not have adverse effects on plant growth (for revegetation needs). However, most resins require a 24-hour cure time after application and traffic should be limited to wheeled equipment only to prevent breakdown of the treated surface. Also, storage temperatures of the emulsion products prior to application must be controlled as they cannot endure freezing or boiling conditions.

### *Polymers*

Polymers include acrylics and vinyls, which are chemical additives mixed with water to form a diluted solution and then applied to the road surface topically. Polymers are generally noncorrosive and nontoxic, and they can be utilized for soil stabilization. As a dust control agent, they are also generally long lasting, although it has been shown that precipitation can affect longevity.

### *Adhesives*

Adhesives are compounds and solutions that are mixed with the soil surface to form a new road surface. One of the most common and well-established dust control adhesives is lignin sulfonate, a waste product from the paper/pulp industry that is created when wood chips are placed in a sulfonate solution. This adhesive is noncorrosive and is easily obtainable due to the large size of the paper/pulp mill industry. Heavily traveled haul roads have been observed to be kept dust free for periods of three to four weeks. However, lignin sulfonate can interfere with some mineral processing processes, such as flotation, and since it is water soluble it can be washed away from the road surface, requiring reapplication to maintain proper dust control [Midwest Research Institute 1981].



Multiple factors can impact the dust control efficiency of the haul road applications, discussed above, including road composition, application concentration, attention to application instructions, traffic type and frequency, and weather conditions. As a result, a range of control efficiencies have been reported and are summarized in Table 5.5.

## Dust Control at the Primary Dump

At surface mines, the coal is typically loaded into haul trucks in the pit and transported to a dump location, which is either a primary hopper or a stockpile. If unloaded to a stockpile, the coal is subsequently transported by a front-end loader to the primary hopper. When the coal is unloaded at the hopper, the coal flowing into the hopper quickly displaces an equivalent volume of air which will carry dust with it as it billows out of the hopper. This dust-laden air can expose the haul truck or front-end loader operator to elevated dust levels if their vehicle is not equipped with an effective enclosed cab filtration system as discussed earlier in this chapter. Other mine personnel, such as crusher operators or maintenance staff, working in the vicinity of the primary dump can also be exposed. Therefore, technologies that are used to control dust liberation at the primary hopper are discussed.

**Table 5.5. Summary of control efficiencies for haul road dust suppressants**

Control type	Efficiency, %	Application frequency	Reference
Water	95	0.5 hours	EPA 1998
	74	3–4 hours	EPA 1998
	40	1 hour	USBM 1983
	55	0.5 hours	USBM 1983
Salt-magnesium chloride	95	22 days	USBM 1987
Salt-calcium chloride	82	2 weeks	USBM 1983
	14	7 weeks	USBM 1983
Petroleum emulsion	70	21 days	USBM 1987
	4–38	4 weeks	USBM 1983
Polymer	74–81	< 4 weeks	USBM 1983
	3–14	> 5 weeks	USBM 1983
	94–100	< 1 week	Gillies et al. 1999
	37–65	11 months	Gillies et al. 1999
Adhesive	50–63	< 4 weeks	USBM 1983

## Enclosure of the Primary Dump

Walls can be constructed around the primary dump location to form an enclosure that should be custom-designed to accommodate the dump vehicles being used. Walls should be physically robust, tight fitting, and designed with proper access for maintenance. Staging curtains, also called stilling curtains, can be hung in the enclosure to provide physical barriers that break up the

natural airflow patterns that are created when a large volume of product is dumped into the enclosure causing dust to billow out of the primary dump as shown in Figure 5.17 [Weakley 2000].

Another option to restrict the dust from escaping the enclosure is installing panels of flexible plastic stripping at the dump side of the enclosure as shown in Figure 5.18. This plastic stripping should contain overlapping sections to provide a flexible seal that resists damage if contacted by the bucket of the front-end loader or the bed of the haul truck during dumping.

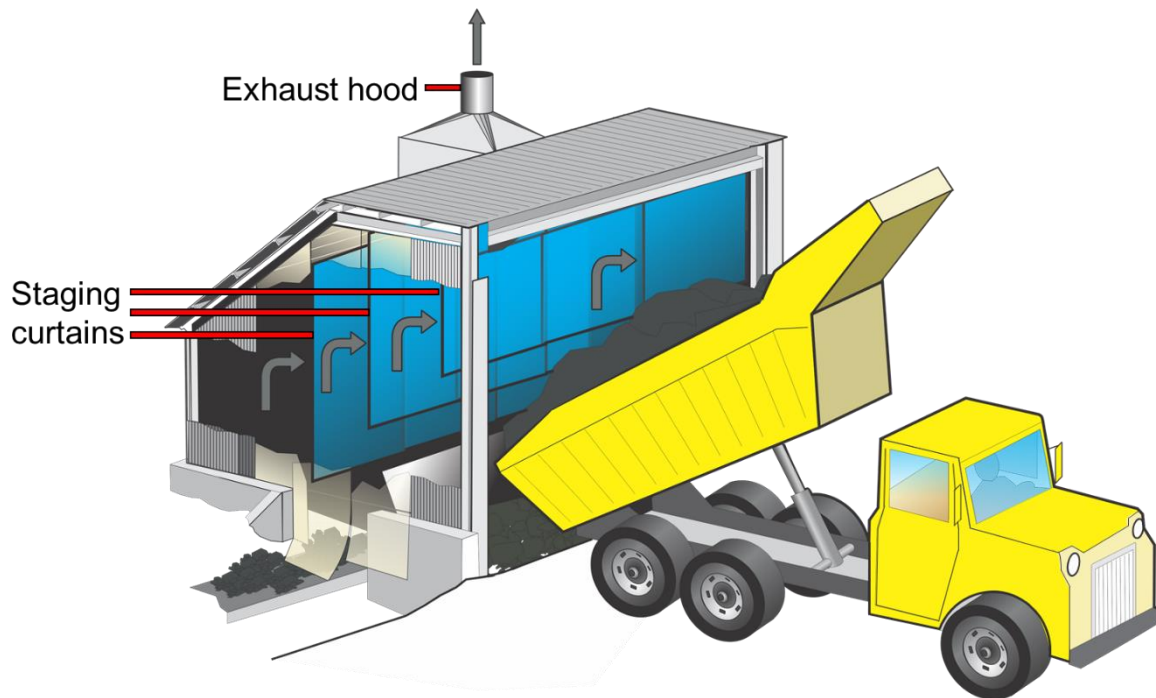

**Figure 5.17. Staging curtains and local exhaust ventilation for controlling dust liberation at a primary dump.**

Finally, a local exhaust ventilation system can be installed to capture and filter the dust-laden air from the enclosed dump area as shown in Figure 5.17. This would be most appropriate when the primary dump is at a location where the dust could enter an adjoining structure or frequently impact workers outside of the dump. Since primary dumps are usually large, the area of any openings in the enclosure should be minimized to avoid dust escape. Typically, a significant amount of exhaust airflow would be required to create a negative pressure to induce air movement into the enclosure. The following equation can be used to estimate the initial exhaust airflow needed to account for the quantity of air displaced by dumping:

$$Q_E = 33.3 \times (600T \div G)$$

where  $Q_E$  = exhaust air volume, cubic feet per minute;

$T$  = weight of material dumped, tons per minute; and

$G$  = bulk density of material, pounds per cubic foot.

Additional design criteria for using exhaust ventilation are provided in Chapter 5 of NIOSH RI 9701 [NIOSH 2019].

## Water Sprays at the Primary Dump

Water sprays can be installed in the primary dump enclosure to assist in controlling dust during coal dumping. Sprays can be directed at the coal product to wet the material in order to suppress dust before it gets airborne. Full cone sprays would be an appropriate choice for wetting and could be placed on both sides of the coal stream as it is unloaded. Figure 5.18 shows sprays mounted at the bucket of the front-end loader and on the enclosure side of the tire stop that are directed at the product stream. The water sprays in the tire stop help prevent dust from rolling back under the dumping point, while the tire stop provides a physical barrier to prevent rollback. Because the tire stop sprays are in a vulnerable location, they should be recessed into the tire stop or shielding should be provided to offer protection for the nozzles.

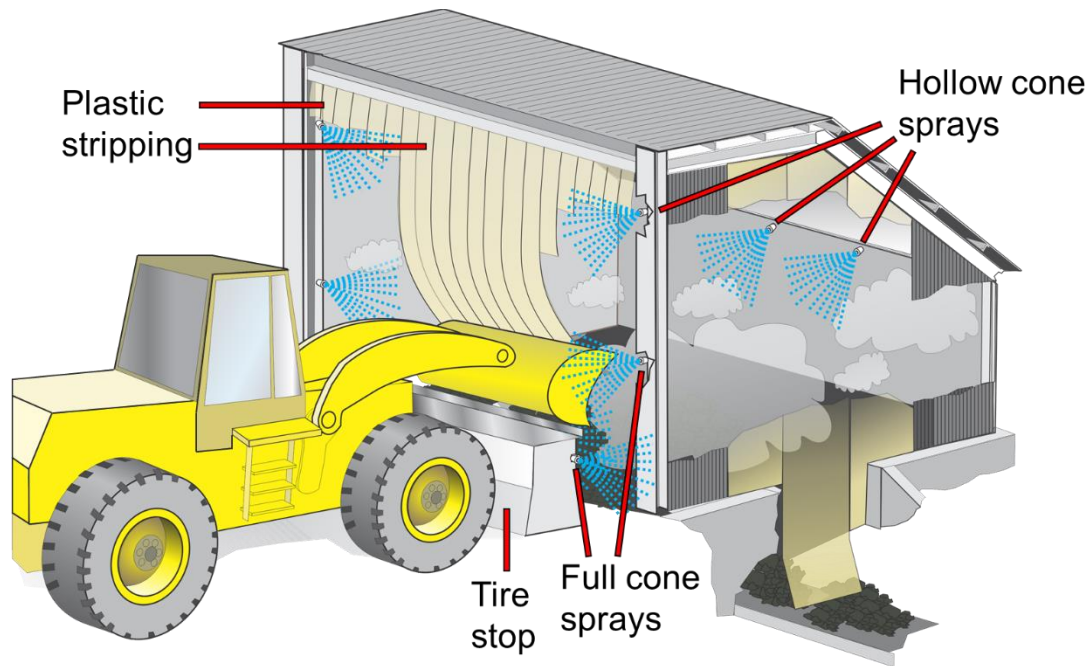

**Figure 5.18. Illustration of a primary dump with full cone water sprays used for wetting while hollow cone sprays are used for airborne dust capture.**

Hollow cone sprays could also be installed in elevated positions in the enclosure to capture dust as it becomes airborne. Figure 5.18 illustrates potential locations for these sprays which should be oriented into the enclosure so that airflow induced by the sprays is directed inward.

## Activation of Dust Controls

Because vehicle presence at the primary dump can occur intermittently, it may be appropriate to have the water sprays and exhaust ventilation system only operate when a vehicle is unloading. A photo cell sensor or mechanical switching device can be used to activate the installed controls. The controls can be programmed to continue to operate for a set period of time after the vehicle has completed dumping to further reduce dust that may still be present in the enclosure. Utilization of an activated system will help to conserve resources and prevent operational problems that may result from continuous water application.

## Stockpile and Preparation Plant Dust Control

The primary focus of this handbook is to identify dust control technologies that can be applied during the extraction and transport of coal from the face to the processing area. No technologies have been discussed that address potential dust control issues for coal storage, processing, or shipment. However, information on dust controls for these sources is available as noted below.

Airborne dust can be generated when loading coal onto a stockpile, moving coal on a stockpile, or unloading coal from a stockpile. Also, high wind velocities can entrain dust from the surfaces of stockpiles and other exposed areas on surface mines. Once airborne, dust from these sources can expose workers, cause visibility problems, and raise concern with the public if dust exits the mine property. A number of control strategies, including wetting with water, chemical applications, wind fences, and enclosures, have been developed to reduce dust liberation from these sources. Details for these controls are discussed in Chapter 11 of NIOSH RI 9701 [NIOSH 2019].

Coal preparation and mineral processing plants utilize similar equipment to process their respective products, which can result in the generation and release of respirable dust into the air. Some of these common processes include crushing, screening, conveying, and loading. USBM IC 9248 [USBM 1990] and Chapters 5 through 9 in NIOSH RI 9701 [NIOSH 2019] describe technologies that can be used to control respirable dust liberation from these sources.

## References for Chapter 5

79 Fed. Reg. 24814 [2014]. Mine Safety and Health Administration: Lowering miners' exposure to respirable coal mine dust, including continuous personal dust monitors; final rule. To be codified at 30 CFR Parts 70, 71, 72, 75, and 90.

Ainsworth SM, Gero AJ, Parobeck PS, Tomb TF [1995]. Quartz exposure levels in the underground and surface coal mining industry. *Am Ind Hyg Assoc J* 56(10):1002–1007.

ASABE [2013]. Tractors and self-propelled machinery for agriculture—air quality systems for cabs—Part 2: Cab & HVAC design. American Society of Agricultural and Biological Engineers, ANSI/ASABE S613-2.1, St. Joseph, MI.

Bennink C [2007]. Haul roads impact tire life. Date accessed: July 26, 2016.

<http://www.forconstructionpros.com/article/10300067/haul-roads-impact-tire-life>

Bolander P, Yamada A [1999]. Dust palliative selection and application guide. U.S. Department of Agriculture, Forest Service, San Dimas Technology and Development Center, Project Report 9977-1207-SDTDC, 20 p.

Bulger C [2015]. Maintaining frictional resistance on mine road surfaces. Queensland Department of Natural Resources and Mines. Date accessed: July 7, 2016.

<https://www.dnrm.qld.gov.au/?a=299155>

CDC [2000]. Silicosis screening in surface coal miners—Pennsylvania, 1996–1997. Centers for Disease Control and Prevention, *MMWR* 49(27):612–615.

CDC [2012]. Pneumoconiosis and advanced occupational lung disease among surface coal miners—16 states, 2010–2011. Centers for Disease Control and Prevention, *MMWR* 61(23):431–434.

Cecala AB, Organiscak JA, Heitbrink WA, Zimmer JA, Fisher T, Gresh RE, Ashley JD II [2003]. Reducing enclosed cab drill operator's respirable dust exposure at a surface coal operation using a retrofitted filtration and pressurization system. Littleton, CO: Transactions of the Society for Mining, Metallurgy and Exploration, Inc., 314:31–36.

Cecala AB, Organiscak JA, Zimmer JA, Heitbrink WA, Moyer ES, Schmitz M, Ahrenholtz E, Coppock CC, Andrews EH [2005]. Reducing enclosed cab drill operator's respirable dust exposure with effective filtration and pressurization techniques. *J Occup Env Hyg* 2(1):54–63.

Cecala AB, Pollock DE, Zimmer JA [2008]. Reducing dust exposure from contaminated work clothing with a stand-alone cleaning system. In: Wallace, ed. Proceedings of 12<sup>th</sup> U.S./North American Mine Ventilation Symposium, Reno, NV, June 9–11.

Cecala AB, Organiscak JA, Zimmer JA, Hillis MS, Moredock D [2009]. Maximizing air quality inside enclosed cabs with a unidirectional filtration and pressurization system. Littleton, CO: Transactions of the Society for Mining, Metallurgy and Exploration, Inc., 326:71–78.

Cecala AB, Organiscak JA, Noll JD [2012]. Long-term evaluation of cab particulate filtration and pressurization performance. Society for Mining, Metallurgy and Exploration, Inc., Transactions, Littleton, CO, 332:521–531.

Cecala AB, Organiscak JA, Noll JD, Zimmer JA [2016]. Comparison of MERV 16 and HEPA filters for cab filtration of underground mining equipment. *Min Eng* 68(8):50–58

Chekan GJ, Colinet JF [2003]. Retrofit options for better dust control—cab filtration, pressurization systems prove effective in reducing silica dust exposures in older trucks. *Aggr Man* 8(9):9–12.

Countess Environmental [2006]. WRAP fugitive dust handbook. WGA Contract #:30204-111. Western Governors Association, Denver, Colorado.

Cowherd C, Mulesky GE, Kinsey JS [1988]. Control of open fugitive dust sources. Environmental Protection Agency Contract No. 68-02-4395, Midwest Research Institute Project No. 8985-14, Research Triangle Park, North Carolina: U.S. EPA, Office of Air & Radiation, Office of Air Quality Planning and Standards.

EPA [1998]. Section 13.2.2 Unpaved roads. In: *Compilation of Air Pollution Emissions Factors, Vol. I: Stationary Point and Area Sources, 5th Edition AP-42*. Research Triangle Park, North Carolina: U.S. Environmental Protection Agency, Office of Air Quality Planning and Standards, Emission Factor and Inventory Group.

EPA [2020]. What is a HEPA filter? U.S. Environmental Protection Agency. <https://www.epa.gov/indoor-air-quality-iaq/what-hepa-filter-1>

Franta RJ [2016]. Personal communication with NIOSH researchers. November 16, 2016.

Gillies JA, Watson JG, Rogers CF, DuBois D, Chow JC, Langston R, Sweet J [1999]. Long-term efficiencies of dust suppressants to reduce PM<sub>10</sub> emissions from unpaved roads. *J Air Waste Man Assoc* 49:3–16.

Hall NB, Halldin CN, Blackley DJ, Laney AS [2020]. Assessment of pneumoconiosis in surface coal miners after implementation of a national radiographic surveillance program, United States, 2014–2019. *Am J Ind Med* <https://doi.org/10.1002/ajim.23184>

James DE, Piechota TC [2008]. Development of improved water spray patterns from construction water trucks. Presentation at Water Smart Innovations Conference and Exposition, Las Vegas, Nevada.

Listak JM, Reed WR [2007]. Water separator shows potential for reducing respirable dust generated on small-diameter rotary blasthole drills. *Int J Min Rec Env* 21(3):160–172.

Massey BA [2017]. Fresh air intake system for overburden drills. U.S. Patent 9,770, 682 B2. Washington, DC: U.S. Patent and Trademark Office.

Midwest Research Institute [1981]. Dust control for haul roads. U.S. Department of the Interior, Bureau of Mines Open File Report 130-81.

Millgate B, Hagan P [2015]. Changes in drilling performance and dust suppression with the use of a water separator sub. In: Aziz N, Kininmonth B, eds. *Proceedings of the 2015 Coal Operators' Conference, Mining Engineering, University of Wollongong, February 18-20*. <https://ro.uow.edu.au/coal/582>

Moosmüller H, Varma R, Arnot WP, Kuhns HD, Etyemezian V, Gillies JA [2005]. Scattering cross-section emission factors for visibility and radiative transfer applications: military vehicles traveling on unpaved roads. *J Air Waste Man Assoc* 55:1743–1750.

MSHA [2020]. MSHA data sets—16. Quartz samples. U.S. Department of Labor, Mine Safety and Health Administration. <https://arlweb.msha.gov/OpenGovernmentData/OGIMSHA.asp>

NAFA [2020]. Understanding MERV/ NAFA user's guide to ANSI/ASHRAE 52.2. National Air Filtration Association. <https://www.nafahq.org/understanding-merv-nafa-users-guide-to-ansi-ashrae-52-2/>

NIOSH [1992]. Preventing silicosis and deaths in rock drillers. U.S. Department of Health and Human Services, Centers for Disease Control and Prevention, National Institute for Occupational Safety and Health, DHHS (NIOSH) Publication Number 92-107, NIOSH ALERT. <https://www.cdc.gov/niosh/docs/92-107/>

NIOSH [1998]. New shroud design controls silica dust from surface mine and construction blast hole drills. By Page SJ, Organiscak JA, Flesch JP, Hagedorn RT. Pittsburgh PA: U.S. Department of Health and Human Services, Centers for Disease Control and Prevention, National Institute for Occupational Safety and Health, Hazard Control 27.

NIOSH [2001a]. Improved cab air inlet location reduces dust levels and filter loading rates. By Organiscak JA, Page SJ. Pittsburgh PA: U.S. Department of Health and Human Services, Centers for Disease Control and Prevention, National Institute for Occupational Safety and Health, Technology News 485.

NIOSH [2001b]. Floor heaters can increase operator's dust exposure in enclosed cabs. By Cecala AB, Organiscak JA. Pittsburgh PA: U.S. Department of Health and Human Services, Centers for Disease Control and Prevention, National Institute for Occupational Safety and Health, Technology News 486.

NIOSH [2001c]. Sweeping compound application reduces dust from soiled floors within operator cabs. By Organiscak JA, Cecala AB. Pittsburgh PA: U.S. Department of Health and Human Services, Centers for Disease Control and Prevention, National Institute for Occupational Safety and Health, Technology News 487.

NIOSH [2003]. Handbook for dust control in mining. By Kissell FN. Pittsburgh PA: U.S. Department of Health and Human Services, Centers for Disease Control and Prevention, National Institute for Occupational Safety and Health, DHHS (NIOSH) Publication No. 2003-147, Information Circular 9465.

NIOSH [2005]. Improve drill dust collector capture through better shroud and inlet configurations. By Organiscak JA, Page SJ. Pittsburgh PA: U.S. Department of Health and Human Services, Centers for Disease Control and Prevention, National Institute for Occupational Safety and Health, Technology News 512.

NIOSH [2008]. Key design factors of enclosed cab dust filtration systems. By Organiscak JA, Cecala AB. U.S. Department of Health and Human Services, Centers for Disease Control and Prevention, National Institute for Occupational Safety and Health: NIOSH Report of Investigations 9677.

NIOSH [2018]. Design, testing, and modeling of environmental enclosures for controlling worker exposure to airborne contaminants. By Organiscak JA, Cecala AB, and Hall RM. Pittsburgh PA: U.S. Department of Health and Human Services, Centers for Disease Control and Prevention, National Institute for Occupational Safety and Health, DHHS (NIOSH) Publication No. 2018-123, Information Circular 9531.

<https://www.cdc.gov/niosh/mining/works/coversheet2046.html>

NIOSH [2019]. Dust control handbook for industrial minerals mining and processing. Second edition. By: Cecala AB, O'Brien AD, Schall J, Colinet JF, Franta RJ, Schultz MJ, Haas EJ, Robinson JE, Patts J, Holen BM, Stein R, Weber J, Strebel M, Wilson L, Ellis M. Pittsburgh PA: U.S. Department of Health and Human Services, Centers for Disease Control and Prevention, National Institute for Occupational Safety and Health, DHHS (NIOSH) Publication No. 2019-124, Report of Investigations 9701.

<https://www.cdc.gov/niosh/mining/works/coversheet2094.html>

Organiscak JA, Reed WR [2004]. Characteristics of fugitive dust generated from unpaved mine haulage roads. *Int J Surf Min Recl Env* 18(4):236–252.

Organiscak JA, Cecala AB, Thimons ED, Heitbrink WA, Schmitz M, Ahrenholtz E [2004]. NIOSH/Industry collaborative efforts show improved mining equipment cab dust protection. *Society for Mining, Metallurgy and Exploration, Inc. Transactions*, Littleton, CO, 314:145–152.

Organiscak JA, Page SJ [2005]. Development of a dust collector inlet hood for enhanced surface mine drill dust capture. *Int J Surf Min Recl Env* 19(1):12–28.

Organiscak JA, Cecala AB, Noll JD [2014]. Using node analysis modeling techniques to predict cab filtration system performance. *Min Eng* 66:52–59.

Page SJ [1991]. Respirable dust control on overburden drills at surface mines. *Coal mining technology, economics, and policy. Proceedings of the American Mining Congress Coal Convention*, Pittsburgh, PA, June 2-5, pp. 523–539.

Page SJ, Organiscak JA [2004]. Semi-empirical model for predicting surface mine drill respirable dust emissions. *Int J Surf Min Recl Env* 18(1):42–59.

Potts JD, Reed WR [2008]. Horizontal air-blocking shelf reduces dust leakage from surface drill shroud. Littleton, CO: *Transactions of the Society for Mining, Metallurgy and Exploration, Inc.*, 324:55–60.

Potts JD, Reed WR [2011]. Field evaluation of air-blocking shelf for dust control on blasthole drills. *Int J Min Rec Env* 25(1):32–40.

Reed WR, Organiscak JA, Page SJ [2004]. New approach controls dust at the collector dump point. *Coal Age* 109(6):20–22.

Reed WR, Organiscak JA [2005]. The evaluation of dust exposure to truck drivers following the lead haul truck. *Trans Soc Min Met Expl Inc.* 318:147–153.

Skorseth K, Selim AA [2000]. Gravel roads: maintenance and design manual. South Dakota Local Transportation Assistance Program, U.S. Department of Transportation, Federal Highway Administration.

Tannant DD, Regensburg B [2001]. Guidelines for mine haul road design. University of British Columbia-Okanagan, School of Engineering. Date accessed: July 7, 2016.

<https://open.library.ubc.ca/cIRcle/collections/facultyresearchandpublications/52383/items/1.0102562>



- Thompson RJ [2020]. Mining roads: mine haul road design, construction & maintenance management. <http://aspasa.co.za/wp-content/uploads/2017/07/road-design-and-maintanance-Molefe.compressed.pdf>
- Thompson RJ, Visser AT [2001]. Mine haul road fugitive dust emission and exposure characterisation. *J Mine Vent Soc of South Africa* 54(1):18–30.
- Thompson RJ, Visser AT [2007]. Selection, performance and economic evaluation of dust palliatives on surface mine haul roads. *J Southern Afr Inst Mining Metallurgy* 107(7):435–450.
- Tomb TF, Peluso RG, Parobeck PS [1986]. Quartz in United States coal mines. In *International Conference on the Health of Miners*, RW Wheeler, ed. Cincinnati, OH: American Conference of Governmental and Industrial Hygienists, pp. 513–519.
- Tomb TF, Gero AJ, Kogut J [1995]. Analysis of quartz exposure data obtained from underground and surface coal mining operations. *Applied Occupational and Environmental Hygiene*, 10(12):1019–1026.
- USBM [1983]. Cost effectiveness of dust control used on unpaved haul roads, Vol. 1 results, analysis, and conclusions. By Rosbury KD, Zimmer RA. U.S. Department of the Interior, Bureau of Mines Open File Report 106-85.
- USBM [1987]. Fugitive dust control for haulage roads and tailings. By Olson KS, Veith DL. U.S. Department of the Interior, Bureau of Mines Report of Investigations 9069.
- USBM [1988]. Impact of drill stem water separation on dust control for surface coal mines. By Page SJ. Pittsburgh, PA: U.S. Department of the Interior, Bureau of Mines, Technology News No. 308.
- USBM [1990]. Dust control in coal preparation and mineral processing plants. By Diver EF, Cecala AB. Pittsburgh, PA: U.S. Department of the Interior, Bureau of Mines, Information Circular 9248.
- Watson JG, Rogers CF, Chow JC, DuBois D, Gillies JA, Derby J, Moosmüller H [1996]. Effectiveness demonstration of fugitive dust control methods for public unpaved roads and unpaved shoulders on unpaved roads. Final Report, DRI Document No. 685-5200.1F1, Prepared for California Regional Particulate Air Quality Study, Sacramento, California: California Air Resources Board.
- Weakley A [2000]. Controlling dust without using bag houses. *Coal Age* 105(11):24–26.
- Zimmer RA, Lueck SR [1986]. Investigation of quartz dust sources and control mechanisms on surface coal mine operations. Volume I—Results, analysis, and conclusions. Golden, CO: PEI Associates, Inc., U.S. Bureau of Mines contract no. JQ348Q32, NTIS: PB 86-215852.
- Zimmer RA, Lueck SR, Page SJ [1987]. Optimization of overburden drill dust control systems on surface coal mines. *Int J Surf Min Rec Env* 1(2):155–157.

## CHAPTER 6: REDUCING FLOAT COAL DUST DEPOSITION

Previous chapters in this handbook have focused on controlling respirable dust generated during the mining and transport of coal in order to reduce the health hazard for miners. Float coal dust is also generated by these same mining processes and poses a serious safety hazard for miners. Float coal dust consists of particles passing a No. 200 sieve [30 CFR 75.400–1<sup>17</sup>]<sup>17</sup>—smaller than 75 micrometers (µm) in size—that are carried by the ventilating air until they deposit onto the roof, ribs, and floor of mine entries. This float coal dust can then be re-entrained into the air, typically by the pressure wave from a methane explosion [NIOSH 2016], which can fuel a more violent coal dust explosion. Once initiated, a coal dust explosion can be self-propagating and widespread throughout a mine in entries where float coal dust has deposited.

In order to mitigate the potential for coal dust explosions, the Mine Safety and Health Administration (MSHA) enforces regulations that are designed to limit the accumulation of float coal dust [30 CFR 75.400] and provide rock dust treatment to inert the float coal dust [30 CFR 75.403]. Sufficient quantities of rock dust (typically limestone) must be applied to raise the total incombustible content of the explosion-entrained mine dust mixture to a minimum of 80%. A challenging aspect of applying rock dust is that it must be repeatedly or continuously applied during production shifts to prevent the development of an explosive coal dust layer on top of an underlying layer of rock dust. NIOSH research has shown that only the top 3/32 to 5/32 inches of the floor dust layer is stripped off or entrained into the air during a typical float coal dust explosion [NIOSH 2006]. This same research showed that a 1/200-inch-thick layer of pulverized coal dust deposited on top of a 3/8-inch-thick uniform concentration of 80% rock dust and 20% float coal dust would propagate an explosion. Figure 6.1 illustrates a similarly explosive thin layer of float coal dust deposited on a layer of rock dust.

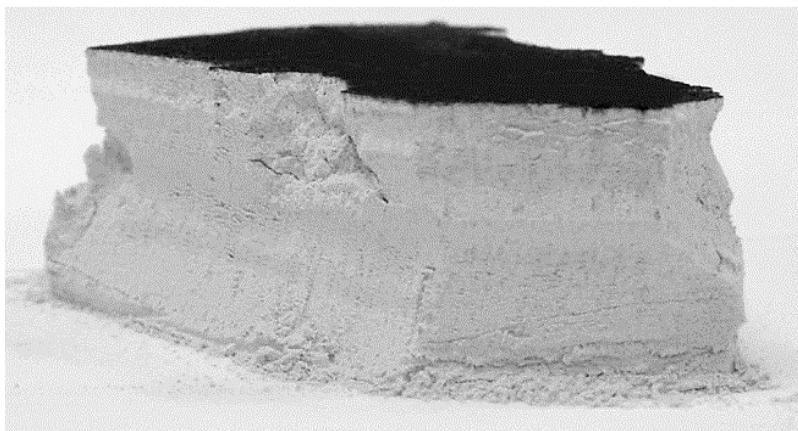

Photo by NIOSH

**Figure 6.1. Cross-section of a 1/100-inch-thick explosible float coal dust layer deposited on top of a 3/4-inch-thick layer of rock dust.**

MSHA routinely inspects mine entries for compliance with the float coal dust regulations and historically, has found many violations. From 2008 through 2014, over 49,000 violations of 30 CFR 75.400 and nearly 11,000 violations of 30 CFR 75.403 were reported [NIOSH 2016].

---

<sup>17</sup> Code of Federal Regulations. See CFR in references.

More recent data on MSHA's website shows that total violations from 2015 through 2020 were 21,500 for 30 CFR 75.400 and over 7,200 for 30 CFR 75.403 [MSHA 2021]. It is apparent that coal mines have had and continue to experience difficulty with controlling and inerting float coal dust depositions. Therefore, NIOSH initiated research to identify control technologies that could be implemented by mines to reduce float coal dust levels. As part of this research effort, NIOSH also investigated methods that could be used to sample float coal dust. Results of this research are discussed below.

## Float Dust Sampling

Past research efforts to quantify float dust deposition in mine entries involved placing deposition pans in the mine entry and allowing the float dust to naturally settle onto plastic sheets [Kost et al. 1981] or "shark skin" filter paper sheets [Bhaskar et al. 1988]. These deposition sheets were then collected and transported to a laboratory for post-weighing to determine the mass of float dust that had settled onto the sheet. Although effective, this sampling technique was time consuming in order to collect sufficient dust mass on the sheets. Also, the sheets were subject to contamination during sampling from material falling from the mine roof. Dust loss or contamination could also occur during the collection and handling of the sheets.

### Institute of Occupational Medicine (IOM) Sampler

For NIOSH's research purposes, a sampling method was desired that would enable the airborne sampling of float-dust-sized particles so that evaluation of control technologies could be conducted in the dust galleries at the Pittsburgh laboratory over shorter time frames. As mentioned previously, float dust is less than 75  $\mu\text{m}$  in size; therefore, samplers that would collect dust encompassing this size range were sought, but none were available to collect this specific size range of particles. A sampler specifically designed to collect the inhalable fraction of airborne dust, which is less than 100  $\mu\text{m}$  as defined by the American Conference of Governmental Industrial Hygienists (ACGIH), was shown to collect a representative sample of particles less than 75  $\mu\text{m}$  [Mark and Vincent 1986]. This Institute of Occupational Medicine (IOM) inhalable sampler has a 15-millimeter (mm) diameter open inlet leading to a 25-mm diameter filter as shown in Figure 6.2, left. The sampler is operated at a flow rate of 2 liters per minute (L/min) and is fabricated in plastic or stainless steel versions. The stainless steel versions have stable mass in different humidity environments [Smith et al. 1998] and were selected by NIOSH for sampling of airborne float dust. The entire sampling cassette is designed to be weighed so that any dust particles that deposit on the walls of the sampler will be included in the measured mass. Past research has shown the IOM sampler provides a representative sample of the defined inhalable particles size distribution [Woehkenberg and Bartley 1998] and is viewed to be a reference sampler for the inhalable fraction [Koch et al. 2002].

Although the standard IOM sampler is an open-face design, NIOSH designed and fabricated an inlet adapter, as a replacement for the front plate, that would allow for isokinetic sampling as shown in Figure 6.2, right [Patts and Barone 2017]. Isokinetic sampling matches the sampler inlet velocity to the velocity of the airstream being sampled, thus minimizing errors resulting from particle inertia in uneven airstreams [Wilcox 1956]. When used for sampling in the laboratory or in mines, air velocity measurements in feet per minute (fpm) were obtained in the entry by NIOSH and the appropriate isokinetic nozzles were used with the IOM samplers.

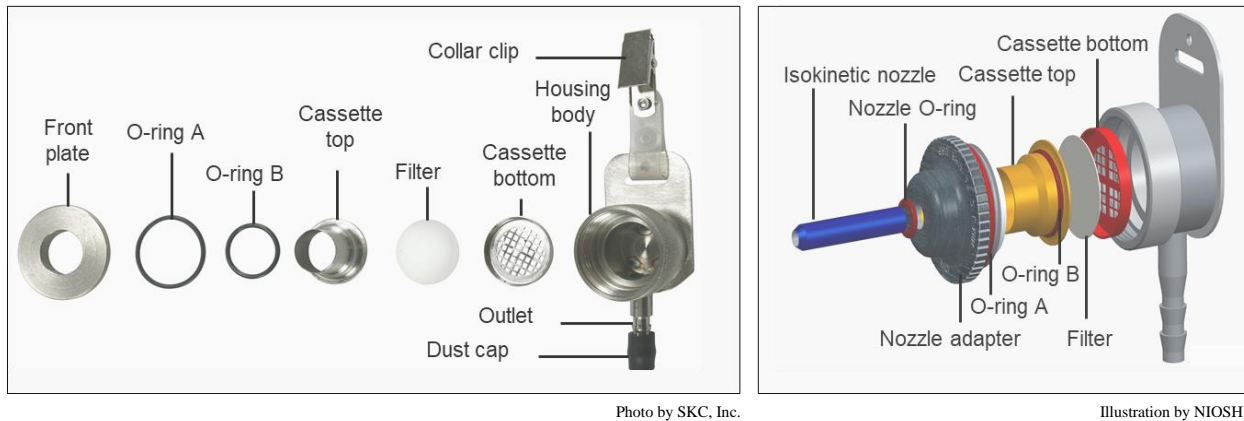

**Figure 6.2. Photo (left) illustrating components of standard stainless steel IOM sampler. Illustration (right) showing the nozzle adapter and isokinetic nozzle designed by NIOSH.**

### *Low-temperature Ashing (LTA)*

As discussed later in this chapter, NIOSH evaluated a flooded bed scrubber that was used with an auxiliary face fan to remove float dust before the ventilating air was discharged into the return entry. Sampling in the heavily rock-dusted return entry allowed limestone rock dust to be entrained in the high-speed air discharged from the auxiliary fan. In order to isolate the impact of the scrubber for reducing float coal dust, a low-temperature ashing (LTA) analytical method was developed by NIOSH to quantify the coal fraction in mixed dust samples collected with stainless steel IOM samplers [Barone et al. 2016]. With this method, the IOM samplers containing the mixed dust samples were heated at 105°C for 2 hours to remove moisture and then weighed to determine dry mass. The samples were then heated at 515°C for 2.5 hours in a muffle furnace to remove the combustible content, which represents the coal portion of the sample. The samples were reweighed to quantify the float coal dust in the samples. Testing using this method with known mixtures of coal and rock dust resulted in measurements that differed in mass by 0.5% or less from the known quantities, validating the method for analyzing mixed dust samples obtained in the mine. This LTA method is similar to the procedures used by the National Air and Dust Laboratory of MSHA to determine incombustible content of float dust samples collected by inspectors [NIOSH 2010].

### *Float Dust Personal Dust Monitor*

In addition to the IOM sampler, NIOSH has also utilized a modified Thermo Scientific PDM3600 Personal Dust Monitor (PDM) for measuring airborne float dust. The Model 3600 and Model 3700 PDMs are near real-time respirable dust samplers approved for use in underground coal mines. The Model 3700 version of the PDM was described in detail in Chapter 2, with current MSHA regulations requiring underground coal mine operators to use this model for respirable dust compliance sampling. The Model 3600 was the original design of the PDM and incorporated a cap lamp with the dust sampler. NIOSH modified the PDM3600 sampler by removing the tapered-element oscillating microbalance (TEOM) module from the body of the sampler and placing it into a NIOSH-fabricated external sampling housing as shown in Figure 6.3, left. Total airborne dust can be collected through an isokinetic nozzle mounted in the top of the external module as shown in Figure 6.3, center. To maintain communication with, supply power to, and pull dust-laden air into the externally operated TEOM module, a second

module was fabricated with the appropriate air and electrical connections as shown in Figure 6.3, center. This second module is inserted into the TEOM port in the PDM body. Float dust samples can be collected with the modified PDM as shown in Figure 6.3, right.

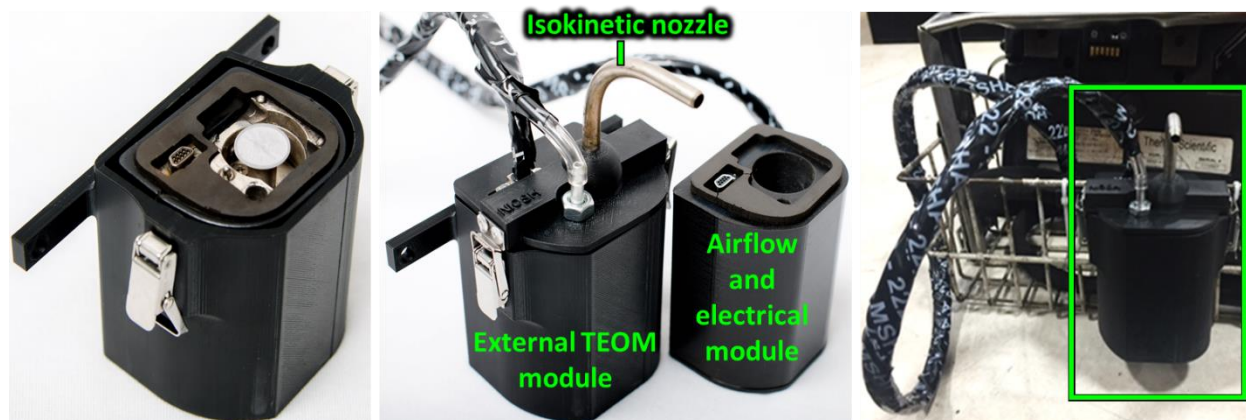

Photos by NIOSH

**Figure 6.3. External sampling housing with the TEOM unit inserted (left). The external TEOM module with isokinetic nozzle is connected to airflow and electrical module (center), which inserts into the PDM body. A modified TEOM module is mounted on a sampling basket (right).**

The advantage of using this modified PDM sampler for airborne float dust sampling is that it records dust mass measurements every minute into a downloadable file. This file can then be used to identify elevated dust periods and to calculate dust concentrations for desired time frames, such as with dust controls on and controls off. NIOSH originally utilized this instrument in laboratory testing and then wanted to use it for underground coal mine sampling. However, because the original PDM3600 design was modified, the intrinsic safety approval for use in underground coal mines was invalidated. As a solution, NIOSH was able to obtain an experimental-use permit from MSHA in order to use this sampler in underground coal mines.

NIOSH conducted five tests in an environmentally controlled dust chamber to compare float dust concentrations measured with two IOM samplers to concentrations measured with two float dust PDMs (unpublished data). The average float dust concentration measured with the IOM samplers was 14.7 milligrams per cubic meter of air ( $\text{mg}/\text{m}^3$ ) and 14.3  $\text{mg}/\text{m}^3$  with the float dust PDMs. The PDMs measured 2.7% less float dust on average than the IOM samplers. This difference was not statistically significant at a 95% confidence level, indicating that the modified PDM provides comparable measurements of airborne float dust.

## Float Dust Control Technologies

NIOSH conducted sampling in the return on a continuous miner section, on a longwall face, and in a belt entry with two transfer points to quantify float and respirable dust levels [Shahan et al. 2017]. The continuous mining section was using exhausting face ventilation developed with tubing and an auxiliary fan located in the return. The longwall was approximately 700 ft long and using bidirectional cutting. The area of the belt entry sampled contained two transfer points approximately 3,800 feet apart. At Transfer A, the belt-to-belt transfer was at a 30-degree angle, while the belt-to-belt transfer at B was a 90-degree transfer.

Additional detail for each of these operations and the specific sampling methodologies can be found in the cited reference.

Airborne float and respirable dust levels from these surveys, measured in  $\text{mg}/\text{m}^3$ , are summarized in Table 6.1. At each of these operations, elevated levels of float dust were generated, particularly on the continuous and longwall sections. As expected, significantly lower levels of respirable dust were measured. These float dust levels indicate that implementation of control technologies would be beneficial at these mining operations.

Similar to the approach discussed for controlling respirable dust, the approach for minimizing float coal dust deposition should begin with achieving efficient cutting to minimize overall dust generation. Then supplemental engineering controls can be implemented to reduce airborne dust levels. Discussion of several supplementary control technologies that have been evaluated for float dust control by NIOSH follows.

**Table 6.1. Summary of float and respirable dust levels for three different mining operations [Shahan et al. 2017]**

<b>Mining operation</b>	<b>Average air velocity, fpm</b>	<b>Sampling location</b>	<b>Float dust, <math>\text{mg}/\text{m}^3</math></b>	<b>Respirable dust, <math>\text{mg}/\text{m}^3</math></b>
Continuous miner	551	200 ft downwind of auxiliary fan	90.1	6.5
		300 ft downwind of auxiliary fan	76.1	6.4
		400 ft downwind of auxiliary fan	68.6	6.7
Longwall	1,158	Intake—last open crosscut	0.50	0.02
		Belt—outby stageloader	1.44	0.25
		180 ft from headgate	14.76	0.80
		380 ft from headgate	56.60	2.63
		690 ft from headgate	52.60	2.65
Belt entry and transfers	89	40 ft upwind of transfer A	0.97	0.09
		10 ft downwind of transfer A	13.27	0.61
		50 ft downwind of transfer A	3.20	0.34
		75 ft downwind of transfer A	3.03	0.31
		3,765 ft downwind of A; 40 ft upwind of B	2.69	0.36
		10 ft downwind of transfer B	11.85	0.94

## Return Entry Flooded Bed Scrubber

Underground coal mines can use auxiliary fans with ventilation tubing to provide exhausting or blowing ventilating air to the mining faces. For exhaust ventilation, an auxiliary fan is located in the return entry and pulls dust-laden air from the face through the tubing. This air is discharged down the return entry, where float coal dust can deposit. It is then necessary to apply sufficient quantities of rock dust to inert the deposited float coal dust.

NIOSH conducted a case study with a mining company to evaluate the use of a flooded bed scrubber installed inline between the ventilation tubing and the auxiliary fan to filter dust out of the ventilating air before it is discharged into the return entry [Patts et al. 2016]. The flooded bed scrubber was approximately 10 ft long by 4.3 ft wide by 5.2 ft high and was mounted on skids as shown in Figure 6.4, left. The stainless steel filter panel was 4.3 ft wide by 3.6 ft high and was wetted by 12 spray nozzles as shown in Figure 6.4, right. A mist eliminator was positioned outby the filter panel to remove dust-laden water from the airstream, which was pumped to a standalone 1.6-cubic-yard recirculation water tank. The water tank contained three cascading settling chambers and was also mounted on skids. Airflow pulled through the scrubber by the auxiliary fan averaged approximately 17,000 cubic feet per minute (cfm) over the three shifts of testing by NIOSH.

A rock duster was positioned at the fan discharge and was operated continuously by the mine. NIOSH planned to place dust sampling stations 200, 300, and 400 ft outby the auxiliary fan in the return. These samplers would be inundated with rock dust under these normal operating conditions. However, the mine received approval from MSHA to place a continuously operating trickle duster just outby the last NIOSH sampling station to dust the majority of the return entry. While NIOSH was sampling when a cut was being taken at the face, the rock duster at the auxiliary fan did not have to be operated. In between cuts and sampling, the rock duster at the fan was operated to apply rock dust to the 400-foot portion of the entry not covered by the trickle duster.



Photos by NIOSH

**Figure 6.4. Flooded bed scrubber unit (left) and 12 water sprays used to wet filter panel (right).**

At each of the three sampling stations, NIOSH collected airborne float dust samples with the IOM sampler, airborne respirable dust samples with 10-mm nylon cyclones, and deposition samples in steel tins. Because of the heavy rock deposition already in the return entry and high discharge velocity of the auxiliary fan, rock dust was entrained into the return air even though the rock duster at the auxiliary fan was not being operated during NIOSH sampling periods. As a

result, the low temperature ashing analytical method mentioned in the previous section was used to quantify the coal dust fraction of the samples collected with the IOM sampler. Average reductions over the three sampling stations was 92.5% for airborne float coal dust, 85.5% for respirable dust, and 84.2% for the deposition samples.

It was apparent that the flooded bed scrubber was effectively removing all sizes of dust particles from the return airstream. To visually illustrate the effectiveness of the scrubber, Figure 6.5, left, shows the return entry after a cut when the scrubber was not being operated, while Figure 6.5, right, shows the same return entry after a cut with the scrubber operating. The left photo shows the dark float coal dust deposited in the entry, while the right photo shows the white rock dust without significant coal dust deposition. Both photos were taken immediately after the cuts were completed and before the application of additional rock dust.



Photos by NIOSH

**Figure 6.5. Return entry after a cut without (left) and with flooded bed scrubber operating (right) illustrating difference in float coal dust deposition.**

## Water Sprays

NIOSH has completed research to quantify the ability of water sprays to capture airborne float coal dust [Beck et al. 2018]. Testing was conducted in a modified section of the NIOSH full-scale longwall dust gallery in Pittsburgh. Line brattice was suspended from the gallery roof to construct an isolated test area that was 62.5 ft long by 5.4 ft high by 3.0 ft wide. Air velocity through the test area was 700 fpm. Feed material for these tests was produced with coal from the Pocahontas 3 seam, with all coal passing through a 200-mesh screen ( $< 75 \mu\text{m}$ ) and having a mean diameter of  $23 \mu\text{m}$ . Dust was dispersed near the test area entrance with a compressed-air-powered venturi educator. A water spray was mounted 24 ft downwind at the roof, and dust sampling was conducted at the exit of the test area (58.5 ft downwind from the dust release point). Dust sampling was conducted with three IOM samplers fitted with isokinetic nozzles. A programmable mobile sampling stand moved the three IOM samplers through an X-Y plane sampling grid containing 15 points (three across and five down). At each sampling point in the grid, dust would be collected for one minute before moving to the next grid point. Utilization of the sampling grid minimized the impact on measurement accuracy resulting from dust gradients that may have been present.

Seven different water sprays were evaluated for their float dust capture ability. These sprays (spray type-spray angle in degrees) included the following:



- a full cone (FC) spray (FC-59)
- two hollow cone (HC) sprays (HC-33) and (HC-81)
- two flat fan (FF) sprays (FF-25) and (FF-50)
- a hydraulic atomizing (HA) spray (HA-88)
- an air atomizing (AA) spray (AA-21)

The FC, HC, FF, and HA sprays were tested at 80 pounds per square inch (psi) (low psi) and 160 psi (high psi). The AA spray was tested with air and water pressure both set to 25 psi (low psi) and then both at 50 psi (high psi). Sprays were angled 45 degrees down from the roof and oriented with the spray directed either into or with the ventilating airflow. Three replicates were completed for each test condition leading to a total of 84 tests.

The FC spray when operated at 160 psi and oriented into the airstream had the highest airborne float coal dust reduction at 40.1%, as shown in Figure 6.6. All sprays except for the AA nozzle when oriented into the air had greater dust collection efficiency when operated at the higher test pressure. This trend matches that found previously for the collection of airborne respirable dust from multiple research efforts [Tomb et al. 1972; USBM 1982; Pollock and Organiscak 2007]. Also, for the HC and FF sprays that were tested with two different spray angles, the wider spray angle resulted in higher dust reductions for all test conditions. Spray orientation had mixed results, with some spray type/pressure combinations showing dust reductions but not others.

Airborne float coal dust reduction, %

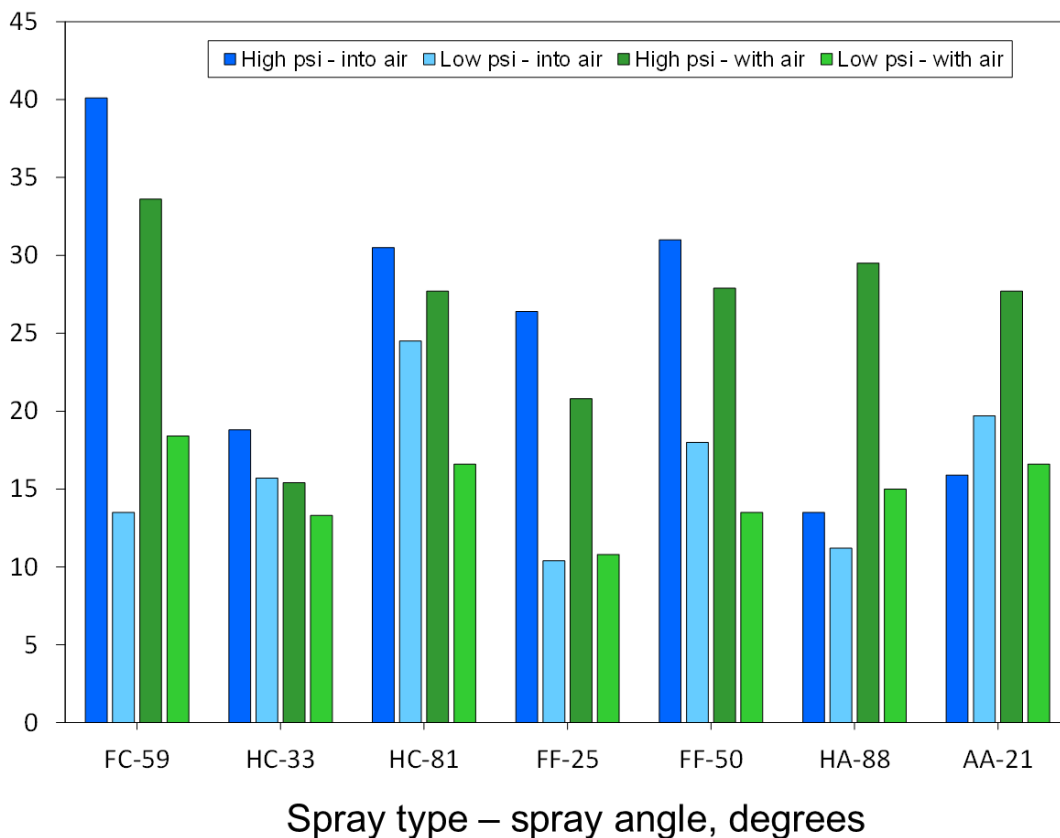

Figure 6.6. Impact of spray type, operating pressure, and orientation on reducing airborne float coal dust.

It should be noted that the sprays traditionally used in underground coal mines (FC, HC, and FF) used between 0.96 and 1.20 gallons per minute (gpm) when operated at 160 psi and between 0.75 and 0.86 gpm when operated at 80 psi [Beck et al. 2018]. In contrast, the HA nozzle only used 0.45 gpm at 160 psi and 0.33 gpm at 80 psi, which is approximately 45% of the water used by the FC spray. Because of the much lower water flow rate used by the HA nozzle, it had the highest dust reduction on a relative per gallon basis when the sprays were operated at 80 psi. This may make it a more desirable selection if water pressure and flow rate are concerns.

### Water Curtain on Longwall

The position of the shearer on the longwall face and the face air velocity will impact the quantity of generated float dust that gets carried to the return entry for any individual longwall. However, the data in Table 6.1 shows that an average of over 50 mg/m<sup>3</sup> of float dust was present just upwind of the return entry. In an effort to reduce the amount of float coal dust entering and depositing in the return, NIOSH investigated the potential dust reduction obtained with a water curtain designed for use on a longwall face [Seaman and Beck 2020]. Testing was conducted in the NIOSH full-scale longwall dust gallery to evaluate single and dual water curtains with different spray nozzle spacing to quantify reductions in float dust levels. Each water curtain contained three spray manifolds approximately three feet in length. The manifolds were mounted to the roof with the sprays oriented downward for testing as shown in Figure 6.7.



Photo by NIOSH

**Figure 6.7. Laboratory testing of a water curtain for reducing float dust on a longwall face.**

Coal dust used for these tests was custom-milled to contain float-dust-sized particles and had a mean particle size of 23  $\mu\text{m}$  as mentioned previously. Dust feed was adjusted to produce a dust cloud of approximately 50 mg/m<sup>3</sup>. Airborne float dust samples were collected with the modified PDM3600 as described earlier in this chapter. Respirable dust samples were collected with a PDM3700 sampler. Two float dust PDMs and one PDM3700 were mounted on a programmable

mobile sampling stand that moved the samplers through an X-Y sampling plane, with each test taking 25 minutes to move through the sampling grid points.

The initial spray bar tested was equipped with 21 full cone sprays spaced six inches apart and operated at 160 psi. These sprays are rated at 1.08 gpm at this operating pressure. Subsequent tests removed sprays which increased the distance between nozzles until only three sprays were operated. The greatest dust reductions were observed with all 21 sprays operating, resulting in a 49% float dust reduction and a 33% reduction in respirable dust. As sprays were removed, the float dust and respirable dust reductions consistently dropped to minimums of less than 20% and 5%, respectively, with three sprays operating. When examining dust reduction per gallon of water used, a nozzle spacing of 12 inches returned the highest per-unit reduction.

Tests were then conducted with two water curtains operating simultaneously. For tests with the spray curtains separated by 6.5 ft and 21 sprays operating in each, float and respirable dust were reduced by 56% and 43%, respectively. Although this dual-bar testing resulted in overall increased dust reductions, the dust reduction per gpm was lower because of using twice as much water. Tests were then conducted to compare the same number of sprays on a single water curtain to an equivalent number of sprays spread over two water curtains—for example, 12 sprays on one bar versus 6 sprays on each of two manifolds with the spacing of the sprays such that they were offset from one bar to the other. These tests showed slight improvements when using two water curtains, but the differences were not significant.

For tests conducted with the spray curtains separated by 42.5 ft and 21 sprays operating in each, float and respirable dust were reduced by 44% and 27%, respectively. These reductions were less than those found for the single spray curtain, so no benefit was realized by separating the water curtains.

This testing illustrates the potential for reducing the quantity of float dust that would enter the return entry with the use of a water curtain on a longwall face. Implementation and testing on an operating longwall are needed to quantify in-mine performance.

### Conveyor Belt Transfer Controls

Transferring coal from one conveyor belt to another releases float and respirable dust into the ambient air and can be a problematic dust source. The application of water and water with an added wetting agent were evaluated by NIOSH at an underground transfer point to determine the potential dust reduction with these controls [Beck et al. 2020]. At the mine test site, coal was transferred from a 48-inch wide discharge belt onto a 48-inch-wide receiving belt, which was oriented 90 degrees to the discharge belt. The coal would drop approximately five feet from the first to second belt. The belt transfer was partially enclosed and had vertical rubber belting installed across the opening of the receiving belt to minimize airflow through the transfer chute. Airflow in the belt entry moved in the opposite direction of belt travel and was less than 100 fpm at the belt transfer location. Average coal flow through the transfer point during testing was 870 tons per hour but fluctuated between 560 to 1,135 tons per hour.

Four water sprays were installed at the belt transfer. Two sprays were mounted above the coal stream at the discharge belt as shown in Figure 6.8, with two other sprays mounted on the underside of the coal stream. All of these sprays had a flat fan spray pattern with a 40-degree spray angle. The sprays were oriented so the spray patterns would cover the full width of the coal stream. The sprays were operated at 35–40 psi, which resulted in a flow rate of 8 gpm and added

moisture to the coal product of 0.24%–0.29% by weight. A material flow sensor monitored the receiving belt to provide input to a controller that would open a solenoid valve in the water supply line to automatically activate the sprays when coal movement was detected on the belt.



Photo by NIOSH

**Figure 6.8. Water sprays directed at top of coal stream being discharged from belt.**

A chemical injection pump was used to supply wetting agent to the water at a concentration of 0.2% for the wetting agent portions of the testing. At the water spray flow rate of 8 gpm, wetting agent usage was approximately one gallon per hour. The goal of adding a wetting agent is to lower the surface tension of the water to aid in improving the capture of coal dust. During these tests, the surface tension of the mine water was measured and found to be 59.5 dynes per centimeter (dynes/cm). With the wetting agent added, the surface tension was lowered to 29.3 dynes/cm.

A baseline test period of two hours was conducted with no water sprays operating and was then followed by a two-hour test period of water only or water with wetting agent added. Five test periods each for water and water with wetting agent were completed. Four dust sampling stations were located around the belt transfer point. At each sampling station, a modified PDM3600 was operated to collect an airborne float dust sample along with a PDM3700 to collect an airborne respirable dust sample. The data from these four sampling locations were used to calculate an average dust concentration for each sampling period. The average dust level for either a water only or water with wetting agent test period was compared to the baseline sampling period immediately preceding it to calculate the dust reduction for that test sequence. The average airborne float dust reduction was 32.3% with water only and 49.5% with wetting agent added. The average respirable dust reduction was 28.3% with water only and 46.4% with wetting agent added. The addition of this control system at the transfer point was effective in reducing both float and respirable dust levels.

## References for Chapter 6

- Barone TL, Patts JR, Janisko SJ, Colinet JF, Patts LD, Beck TW, Mischler SE [2016]. Sampling and analysis method for measuring airborne coal dust mass in mixtures with limestone (rock) dust. *J Occ Env Hyg* 13(4):288–296.
- Beck TW, Seaman CE, Shahan MR, Mischler SE [2018]. Open-air sprays for capturing and controlling airborne float coal dust on longwall faces. *Min Eng* 70(1):42–48.
- Beck TW, Seaman CE, Klima SS [2020]. Dust control at a belt conveyor transfer point using water sprays and a wetting agent. Society of Mining, Metallurgy, and Exploration Annual Meeting, Phoenix, AZ, February 23–26, Preprint 20-110.
- Bhaskar R, Ramani RV, Jankowski RA [1988]. Experimental studies on dust deposition in mine airways. *Min Eng* 40(3):191–195.
- CFR. Code of Federal regulations. Washington, DC: U.S. Government Printing Office, Office of the Federal Register.
- Koch W, Dunkhorst W, Lodding H, Thomassen Y, Skaugset NP, Nikanov A, Vincent J [2002]. Evaluation of the Respicon® as a personal inhalable sampler in industrial environments. *J Env Mon* 4(5):657–662.
- Kost JA, Colinet JF, Shirey GA [1981]. Field survey of float dust in coal mining operations. Monroeville, PA: Bituminous Coal Research, Inc., U.S. Bureau of Mines contract no. J0308030, NTIS Publication No. PB82-172719/XAB.
- Mark D, Vincent JH [1986]. A new personal sampler for airborne total dust in workplaces. *Ann Occ Hyg* 30(1):89–102.
- MSHA [2021]. Top 20 most frequently cited standards by mine type. U.S. Department of Labor, Mine Safety and Health Administration. <https://www.msha.gov/top-20-most-frequently-cited-standards-mine-type>
- NIOSH [2006]. Float coal dust explosion hazards. Pittsburgh, PA: U.S. Department of Health and Human Services, Centers for Disease Control and Prevention, National Institute for Occupational Safety and Health. DHHS (NIOSH) Publication No. 2006-125, Tech News 515.
- NIOSH [2010]. Recommendations for a new rock dusting standard to prevent coal dust explosions in intake airways. By Cashdollar KL, Sapko MJ, Weiss ES, Harris ML, Man CK, Harteis SP, Green GM. Pittsburgh, PA: U.S. Department of Health and Human Services, Centers for Disease Control and Prevention, National Institute for Occupational Safety and Health. DHHS (NIOSH) Publication No. 2010-151, Report of Investigations 9679.
- NIOSH [2016]. Review of rock dusting practices in underground coal mines. By Harteis SP, Alexander DW, Harris ML, Sapko MJ, and Weiss ES. Pittsburgh, PA: U.S. Department of Health and Human Services, Centers for Disease Control and Prevention, National Institute for Occupational Safety and Health. DHHS (NIOSH) Publication No. 2017-101, Information Circular 9530.
- Patts JR, Colinet JF, Janisko SJ, Barone TL, Patts LD [2016]. Reducing float coal dust: Field evaluation of an inline auxiliary fan scrubber. *Min Eng* 68(12):63–68.

Patts JR, Barone TL [2017]. Comparison of coarse coal dust sampling techniques in a laboratory-simulated longwall section. *J Occ Env Hyg* 14(5):323–334.

Pollock D, Organiscak J [2007]. Airborne dust capture and induced airflow of various spray nozzle designs. *Aer Sci Tech* 41(7):711–720.

Seaman CE, Beck TW [2020]. Laboratory testing of a water curtain designed to reduce float dust accumulations in longwall returns. Society of Mining, Metallurgy, and Exploration Annual Meeting, Phoenix, AZ, February 23–26, Preprint 20-032.

Shahan MR, Seaman CE, Beck TW, Colinet JF, Mischler SE [2017]. Characterization of airborne float coal dust emitted during continuous mining, longwall mining and belt transport. *Min Eng* 69(9):61–66.

Smith JP, Bartley DL, Kennedy ER [1998]. Laboratory investigation of the mass stability of sampling cassettes from inhalable aerosol samplers. *Am Ind Hyg Assoc J* 59(8):582–585.

Tomb TF, Emmerling JE, Kellner RH [1972]. Collection of airborne coal dust by water spray in a horizontal duct. *Am Ind Hyg Assoc J* 33(11):715–721.

USBM [1982]. Dust knockdown performance of water spray nozzles. Pittsburgh, PA, U.S. Department of the Interior, Bureau of Mines, Technology News No. 150.

Wilcox JD [1956]. Isokinetic flow and sampling. *J Air Pol Con Assoc* 5(4):226, 245.

Woehkenberg ML, Bartley DL [1998]. Inhalable aerosol samplers. *Appl Occup Env Hyg* 13(5):274–278.



Promoting productive workplaces through safety and health research

DHHS (NIOSH) Publication No. 2021-119

DOI: <https://doi.org/10.26616/NIOSH PUB2021119>